

FOR A GOOD **REASON** **GRUNDIG**

en

Owner's Manual

Digital Recording Systems

GRI-K1104A	4-Ch Full HD Standalone H.264 NVR
GRI-K2208A	8-Ch Full HD Standalone H.264 NVR
GRI-K4416A	16-Ch Full HD Standalone H.264 NVR

GRI-K4416A.81.1.14.12.2012
© ASP AG



Content:		7. System Setup	55
1. Introduction	1	8. Storage	61
1. Key Features of your NVR	2	9. Event Setup	64
2. Important Safety Instructions	3	7. Record Setting	75
3. Package Contents	4	1. Starting the Record Setup Menu	75
4. Installation	5	2. Record Setup	75
1. Connections and Control Keys	5	8. Search	83
2. HDD Specifications & Replacement	8	1. Moving To The Search Menu	83
3. Basic Layout	10	2. Search Settings	83
4. Connecting To An External Device	10	9. Playback	88
5. Monitoring	19	1. Using the Playback	88
1. Start	19	10. Archiving	91
2. Login	19	1. Starting the Archive Menu	91
3. Logout	20	11. Web Remote Viewer	96
4. System Shutdown	21	1. What is the Web Remote Viewer?	96
5. Live Screen At a Glance	21	2. Live	98
6. System Setting	34	3. Search	102
1. Moving To The System Setup	34	4. Setup	105
2. Camera Setting	34	12. Archive Viewer	125
3. Display Setting	42	1. Starting the Backup Player	125
4. Audio Setup	47	2. Backup Player At a Glance	127
5. User Setting	48		
6. Network Setup	51		

1. Introduction

Thank you for purchasing a GRUNDIG digital network video recorder.

This manual is for GRI-K1104A, GRI-K2208A and GRI-K4416A. Before product installation and operation, please become thoroughly familiar with this user manual and other manuals referenced by this manual.

This user manual, the software and the hardware described here are protected by copyright law. With the exception of copying for general use within fair use, copying and reprinting the user manual, either partially or in entirety, or translating it into another language without the consent of ASP AG is strictly prohibited. This specification may change without prior notice for improvement of product performance.

Product Warranty and Limits of Responsibility:

The manufacturer does not assume any responsibility concerning the sale of this product and does not delegate any right to any third party to take any responsibility on its behalf. No warranty is offered for any attachments or parts not supplied by the manufacturer. The product warranty does not cover cases of accidents, negligence, alteration, misuse or abuse, for example:

-
- Malfunctions due to negligence by the user
 - Deliberate disassembly and replacement by the user
 - Connection of a power source other than a properly rated power source
 - Malfunctions caused by natural disasters (fire, flood, tidal wave, etc.)
 - Replacement of expendable parts (HDD, FAN, etc.)
 - Malfunction caused by using an unrecommended HDD
 - Malfunction due to HDD failure and not due to a problem in the NVR
 - The warranty period for the Fan is one year after purchase.

This product is not for exclusive use of crime prevention but also for assistance in cases of fire. We take no responsibility for damage from any incident.

Caution:

This equipment underwent EMC registration and is suitable for business purposes. Distributors and users are aware of this point.

Warning:

This is a class A product. In a domestic environment this product may cause radio interference, in which case the user may be required to take adequate measures.

Warning:

1. In case of changing the built-in lithium battery, it should be replaced with the same or a kindred one to prevent danger of explosion. Since old batteries could be a factor of environment contamination, be cautious how you treat them.
2. Do not throw the batteries into fire or other heat. Short circuit or disassembly is prohibited.
3. Do not charge the batteries provided with the remote control.

1.1. Key Features of your NVR

This product allows you to receive audio and video signals from a max. of 4/8/16 CH 1080p H.264 network cameras before saving the signals to the internal HDD. Besides, you can also transfer them to an external device that can be monitored remotely on your PC or mobile phone.

- Displays the video from up to 4/8/16 CH 1080p network cameras in real-time (Max. 120/240/480 fps)
- Saves the video from up to 4/8/16 CH 1080p network cameras in max. 32/64Mbps (8Mbps per channel) (Max. 120/240/480 fps)
- Plays up to 4/8/16 CH 1080p videos in real-time (Max. 120/240/480 fps)
- H.264 BP/MP/HP network cameras are supported (BP: Baseline profile, MP: Main profile, HP: High profile)
- Supports PoE (for cameras) for all channels
- Built-in 4/8 port PoE switching hub (40W/72W)
- 'Plug & Display' camera connection
- Protects the IP camera via secured closed circuit LAN environment
- Auto notification with self diagnosis (HDD S.M.A.R.T, temperature, network connection status, fan error, etc.)
- Dual streaming supported for a remote display
- Auto resolution & FPS adjustment for a remote service
- External eSATA HDD supported – various search methods (time, event, bookmark and thumbnail)
- Various search methods (time, event, bookmark and thumbnail)
- Mass storage backup via USB port or FTP server
- Dedicated smart phone applications that can be used with iPhone and iPad or on Android OS (under development)

- 1080p Full HD GUI

2. Important Safety Instructions

GRUNDIG shall not have any responsibility for any accident or damage that may incur during the use of this product. For your safety, we provide a few instructions about installation, manipulation, cleaning, assembly/disassembly of the product as below. So please read carefully and comply with the instructions.

Before installation :

Comply with the following instructions to prevent a fire, explosion, system failure or electric shock.

- Remove the power supply before proceeding.
- Check the input voltage (AC100V–AC240V) of the power supply before connecting it.
- Keep the product away from humidity.
- Ensure that all devices connected to the product are properly earth-grounded.

During installation :

To prevent an accident or physical injury and to operate the NVR properly, please comply with the following:

- Secure at least 18 centimeter of distance between cooling fan and wall for a proper ventilation.
- Install the product on a flat surface.
- Keep it away from direct sunlight or excessive temperature.

In operation mode :

Comply with the following instructions to prevent a fire, explosion, system failure or electric shock.

- If you need to open the cover, consult with a service person who could help you to do what you want to do.
- Do not connect multiple devices to a single power socket.
- Keep the product away from dust or too much combustible substances (ex: propane gas).
- Do not touch it with a wet hand.
- Do not insert a conductor in the vent of the ventilation system.
- Do not apply excessive force to unplug the power cord.

While in use :

- Do not apply force to it or shake it while using it.
- Do not move, throw away or put excessive force to it.
- Using any unrecommended HDD may cause a system failure. Check the compatibility list and use only compatible HDDs. (A system failure or data loss caused by an incompatible HDD will void your warranty.)

Disassembly & Cleaning :

- When cleaning the surface, use a dry cloth.
- Do not wipe the product using water, paint thinner or organic solvents.
- Do never dismantle, repair or modify the product by your own.

The content of this manual can differ according to firmware or software upgrading. The standard and appearance of the products may be changed for the improvement of quality without prior notice.

3. Package Contents

These parts are included:



Mouse



Remote Control &
Batteries (AAAx2)



Power Cable x2



DC 12V Adapter
(for 4/8 ch NVR only)



DC 48V Adapter



Screws



Adapter Cable
Retainer Clip x2
(for 4/8 ch NVR only)



CD



Quick Guide



External PoE Hub
(for 8-channel extension)
(for 16ch NVR only)







Terminal Blocks x2
(for 16ch NVR only)

4. Installation

4.1. Connections and Control Keys

Front View:

Name		Description
IR Remote Control Receiver		Receives the signal from the remote control.
USB		Used for connecting USB storage or mouse.
Status LED		Shows the status of power, recording or network connection together with the corresponding alarm.
HDD1-5/eSATA*		Indicates the connection status of the internal/external storage devices. *Only for 16ch NVR.

Rear View of the recorder model GRI-K1104A:

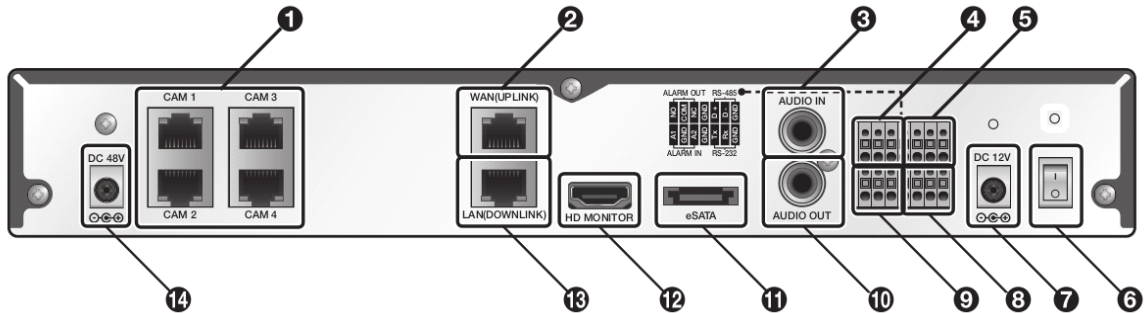

Rear View of the recorder model GRI-K2208A:

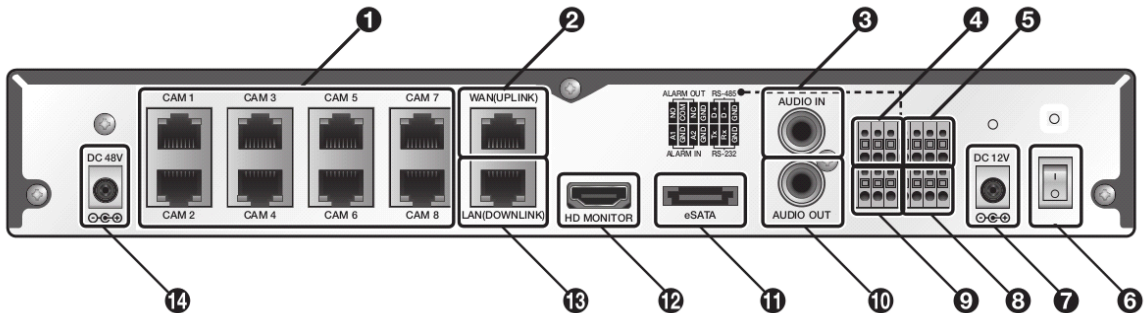

No.	Name	Description
1	CAM1-CAM8	Ethernet ports used for connecting the network camera video and the power.
2	WAN(UPLINK)	Network port for connection to the Internet, router or hub.
3	AUDIO IN	Microphone connection port.
4	ALARM OUT	Alarm output device connection port.
5	RS-485	Communication port for connecting peripherals such as a system keyboard.
6	Power Switch	NVR power switch. Plug the power cord in and turn this switch on.
7	DC 12V	NVR power input port. Connect to a 12V adaptor.
8	RS-232C	Signal connection port for POS and ATM. √ POS & ATM integration will be implemented at a later time.
9	ALARM IN	Alarm input signal port.
10	AUDIO OUT	Port for speaker connection.
11	eSATA	Connection port for external SATA storage.
12	HD MONITOR	Port for connecting a Full HD (1920x1080) supported monitor. Use the HDMI cable to connect with a 1080p 60Hz monitor.
13	LAN(DOWNLINK)	Port for connecting the dedicated network device. [Do not share with another device.]
14	DC 48V	Power input port for the camera [PoE compliant]. Connect to a 48V adaptor.

Rear View of the recorder model GRI-K4416A:

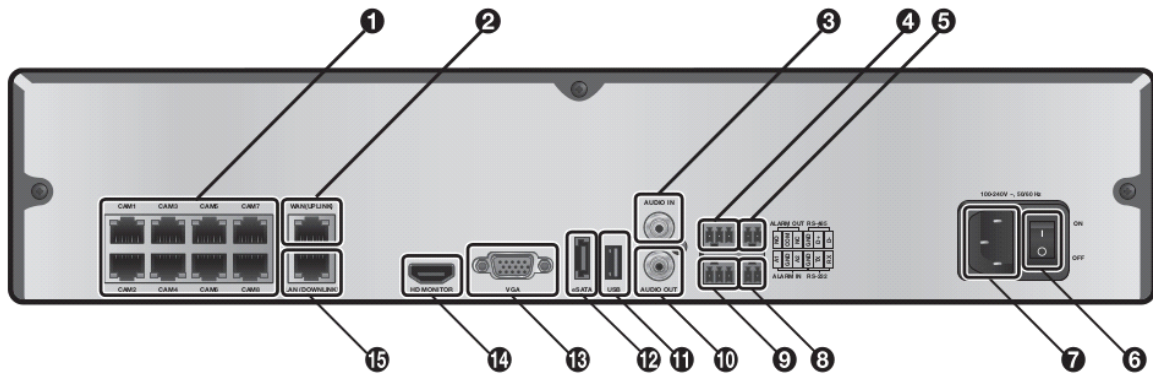

No.	Name	Description
1	CAM1~CAM8	Ethernet ports used for connecting the network camera video and the power.
2	WAN(UPLINK)	Network port for connection to the Internet, router or hub.
3	AUDIO IN	Microphone connection port.
4	ALARM OUT	Alarm output device connection port.
5	RS-485	Communication port for connecting peripherals such as a system keyboard.
6	Power Switch	NVR power switch. Plug the power cord in and turn this switch on.
7	100-240V -, 50/60 Hz	NVR power input port.
8	RS-232C	Signal connection port for POS and ATM. √ Scheduled to be upgraded.
9	ALARM IN	Alarm input signal port.
10	AUDIO OUT	Port for speaker connection.
11	USB	Port for connecting USB devices (for a mouse, a backup device or for firmware updating).
12	eSATA	Connection port for external SATA storage.
13	VGA	VGA video output terminal.
14	HD MONITOR	Port for connecting a full HD(1920x1080) supported monitor. Use the HDMI cable to connect with a 1080p 60Hz monitor.
15	LAN(DOWNLINK)	Port for connecting the dedicated network device. (Do not share with another device.)

Remote Control:

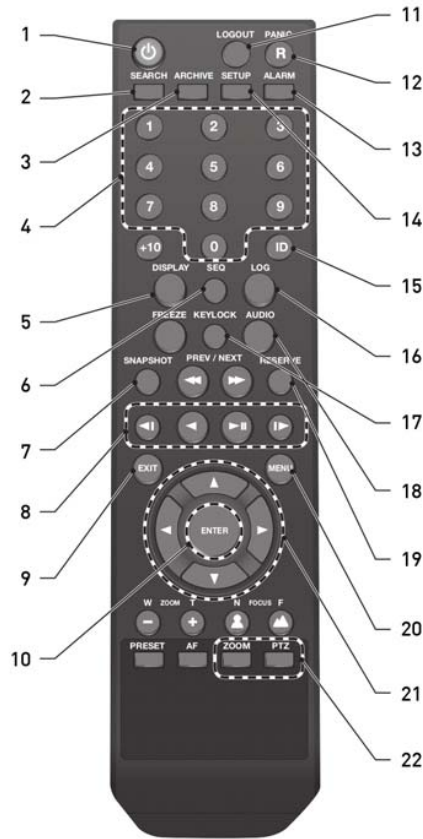

No.	Name	Description
1	POWER	Turns the power on or off.
2	SEARCH	Displays the search window.
3	ARCHIVE	Displays the backup window.
4	CHANNEL	Functions as channel selection button in live or playback mode. Or used for entering the password.
5	DISPLAY	Switches the split mode.
6	SEQ	Switches to sequence mode.
7	SNAPSHOT	Takes a snapshot of the video.
8	◀ / ◀ / ▶■ / ▶	Used to change the direction or adjust the play speed in playback mode.
9	EXIT	Exit from the current screen and return to the previous screen.
10	ENTER	Select a menu item or apply your settings.
11	LOGOUT	Log out.
12	PANIC	Start the emergency recording.
13	ALARM	Shows the alarm status with a popup window.
14	SETUP	Displays the system setup menu.
15	ID	Set the remote control ID.
16	LOG	Displays the log list.
17	KEYLOCK	Locks any operation on the unit.
18	AUDIO	Displays the audio channel selection window.
19	RESERVE	Reserves the current video.
20	MENU	Displays the tool bar on the live screen.
21	◀/▶/▲/▼	Used to move through the menus.
22	PTZ/ZOOM	Enter the PTZ or digital zoom mode and control the operation.

The remote control will only be active if the remote control ID matches with that specified on the NVR. If multiple NVRs are installed on one place and you have just a single remote control, use the ID button to set the remote control ID. Only the ID-matching NVR can be controlled.

1. Under <SYSTEM> - <CONTROL DEVICE> in the System Setup menu, set the <REMOTE CONTROLLER ID> and press <APPLY>. Select between 00 and 99. For more details, please refer to <SYSTEM SETUP>. The remote control will be active only if the remote control ID matches the system ID of the NVR.

2. Press the [ID] button on the remote control. The default remote control ID is 00.

3. Use the number buttons to provide a two-digit ID. If you want to enter 01, for instance, enter the number 0 and 1 in sequence. Check if the remote control ID is set properly by manipulating the remote control.

4. To reset the ID to 00, press and hold the [ID] button.

4.2. HDD Specifications & Replacement

Specifications of compatible HDDs:

Maximum SATA Speed:

- SATA1(1.5G) : Can be used

- SATA2(3.0G) : Can be used

- SATA3(6.0G) : Devices of backward compatibility to SATA2 (3.0G) can be used.

Maximum Start-up Current: 12V, 2A (or lower)

Maximum Average Operation Power Consumption: 7W (or lower)

Maximum R/W Latency: Latency (Read: 13ms / Write: 13ms) or smaller

ATTENTION:

- Use 3.5" HDD disks.

- Using HDD devices other than described in the recommended specifications above may cause serious problems.

- For further information about the HDD specifications, refer to the applicable data sheet of the HDD manufacturer.

The users can replace the hard disk if the existing one reaches its full capacity or becomes problematic.

HDD Replacement Procedure for GRI-K1104A and GRI-K2208A:

1. At the bottom of the NVR are two metal compartments that are slide-in brackets for the HDDs. They are screwed with one screw each to the NVR main unit (there are also 4 screws, two on each side of the bracket that hold the HDD in place). Loosen the screw of the HDD compartment/bracket of which you would like to exchange the HDD (they are marked with "HDD1" and "HDD2").

2. After loosening the screw, you can slide the bracket out of the main unit.

3. Once the HDD bracket is separated from the main unit, remove the 4 screws on top of the HDD bracket to separate the HDD from the bracket.

4. Install a new HDD and fasten the 4 screws back to the top of the bracket to fix it.

NOTE: When installing the HDD, make sure to install it in the correct direction.

5. Now you can slide the HDD bracket back into the main unit and fasten the screw again.

HDD Replacement Procedure for GRI-K4416A:



1. Remove the 2 screws on both ends of the NVR.

2. Pull the front side of the unit forward to separate it.

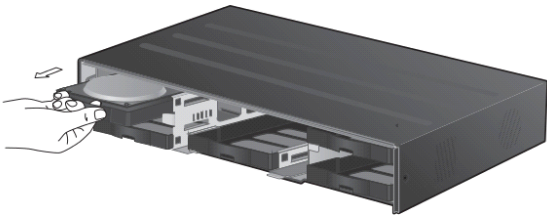

3. Hold the middle of the HDD bracket's handle with the index finger and pull it forward while sustaining the bracket handle with your thumb and middle finger as shown in the illustration below.

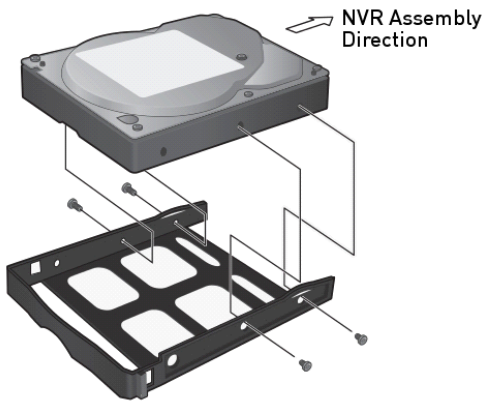
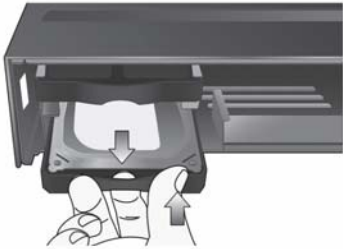

4. Once the HDD bracket is separated from the main unit, remove the 4 screws on both ends of the HDD bracket to separate the HDD from the bracket.

5. Install a new HDD and fasten the 4 screws back to both ends of the bracket to fix it.

NOTE: When installing the HDD, make sure to install it in the correct direction.

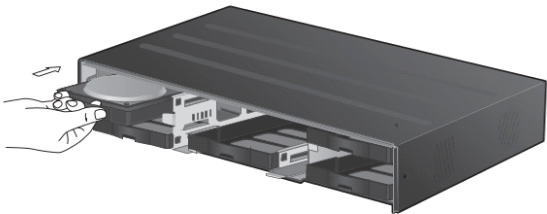

6. Push the bracket installed with the new HDD back into the main unit until it is completely inserted.

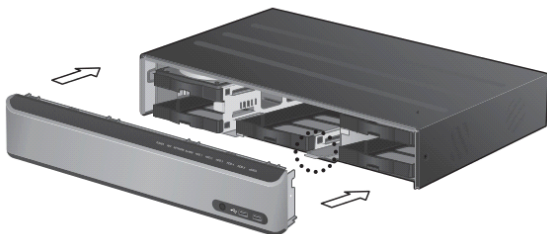

7. Assemble the front panel back to the unit.

ATTENTION: When assembling the front panel to the main unit, make sure the marked part is tightly attached.

8. Fasten the 2 screws on both ends of the main unit.

4.3. Basic Layout

Basic Layout:

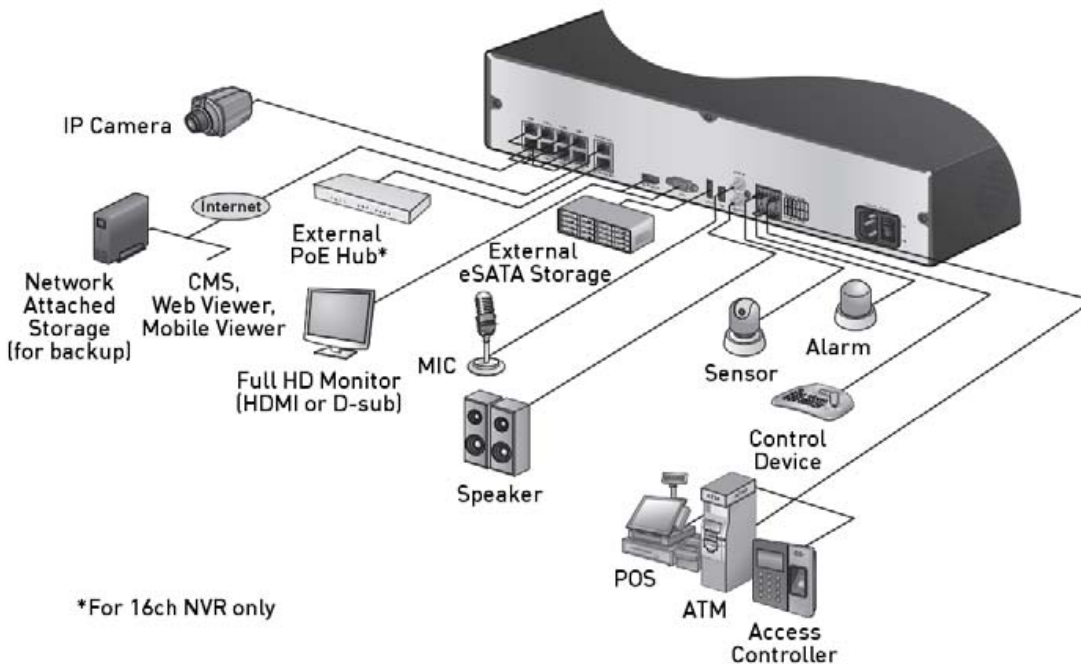

4.3.1. Precautions

To secure the recording stability from an overloaded network traffic, and to protect the NVR from hacking attempts or DoS (Denial of Service) attacks, only the direct cable connection between camera and NVR is allowed. Using a hub is only allowed for extending a single channel to an extended transfer range of 100m each. Any access from an outside PC to the IP camera will be strictly prohibited for the purpose of secure operation. Signal connection for POS and ATM is planned to be integrated later.

4.4. Connecting To An External Device

4.4.1. Connecting the Monitor

For GRI-K1104A and GRI-K2208A:

This product supports only monitor models featuring 1080p 60Hz HDMI or DVI inputs. Connect the HDMI cable with the HDMI output port in the bottom rear panel and the HDMI port of the monitor, or use the HDMI-to-DVI cable to connect the NVR with the DVI port of the monitor.

For GRI-K4416A:

This product supports VGA (D-sub) monitors that support the resolution of 1080p 60Hz HDMI or 1920x1080. Connect the product with a HDMI cable by connecting it to the HDMI Out port under the unit and the HDMI Input port of the monitor. Or use a HDMI-to-DVI cable for connecting the product's HDMI port and the monitor's DVI port. You can use a VGA (D-sub) cable to connect this product and the VGA port of the monitor. Output for two monitors at the same time is not supported. You can either connect the HDMI or the VGA output to one single monitor.

4.4.2. Power Connection

Guidelines for this connection:

- Make the connection when the power is not applied yet.
- Arrange the cables and be careful not to peel off the cable coating.
- Do not place the power cord under a carpet or rug. The power cord is usually earth-grounded. However, even if it is not earth-grounded, do never modify it on your own for earth-grounding.

- Do not insert multiple devices into a single power socket. Otherwise, it may cause a power overload.
- For a stable power supply, this product provides two separate adapters and two corresponding AC cords by factory default. Make sure all cables are connected properly.
- Make sure the power connector and the cable are connected tightly and are not loose.

Power connection for GRI-K1104A and GRI-K2208A:

Two adaptors are provided: one for NVR operation (DC 12V), and the other for PoE (Power Over Ethernet, 48V).

NVR power connection :

Plug the provided DC 12V adapter in the rear power port of the NVR.

PoE Switching hub power connection :

Plug the provided DC 48V adapter in the rear power port of the NVR. When done, attach the adaptor cable clip to the rear panel and insert the cable.

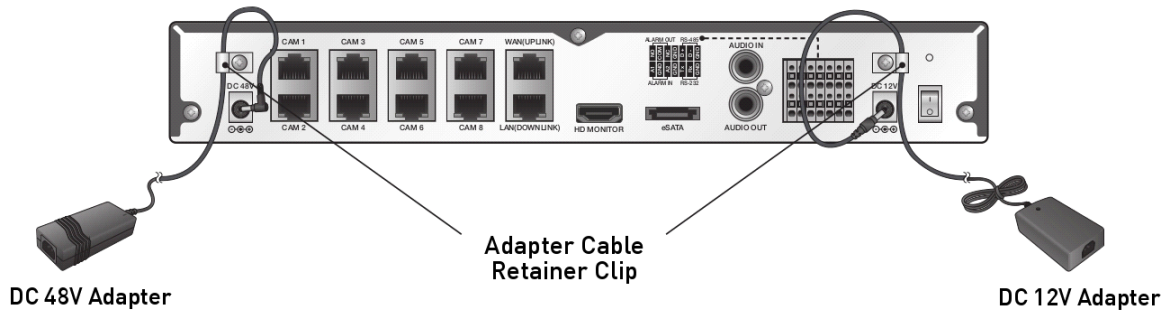

Power connection for GRI-K4416A:

Apply power to the NVR main unit, and connect the provided DC 48V power supply adaptor to the External PoE Hub (Power Over Ethernet, for 16-channel models).

NVR power connection:

Connect the provided power cord to the power inlet.

External PoE Hub power connection:

Plug the provided DC 48V adaptor in the rear power port of the Hub.

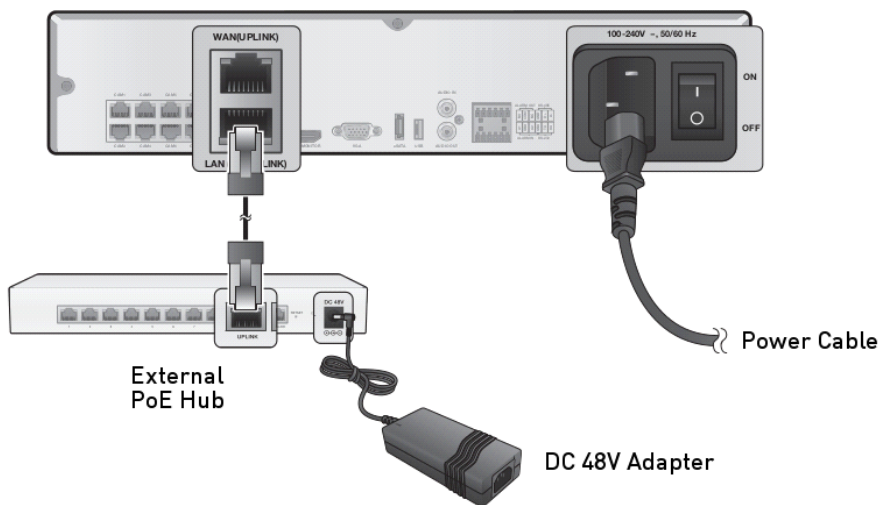

4.4.3. Connecting the Camera

Guidelines for this connection:

- If the IP camera provides the Alarm I/O port or Audio I/O port, you can make the alarm or audio connection. For more details, please refer to the user manual of the IP camera.
 - The Ethernet connection is effective within 100 meters in distance. Beyond that, you may encounter a data loss or failure to connect to the camera. If you need to make a cable connection that is longer than 100 meters, please use a separate PoE extender for cable extension.
 - The total power consumption of the IP cameras should not exceed the rated power capacity of the 48V PoE adaptor (Main Unit: 95W, External PoE Hub: 72W)*. If it exceeds the nominal power capacity, the video may not be played properly or no video will be displayed at all. If this is the case, use a separate (additional) power source for supplying power to the cameras.
- *Only for the 16Ch NVR model GRI-K4416A.
- Per channel the NVR max. supplies 15W. If a camera requires more power, please use an external power supply for this camera.

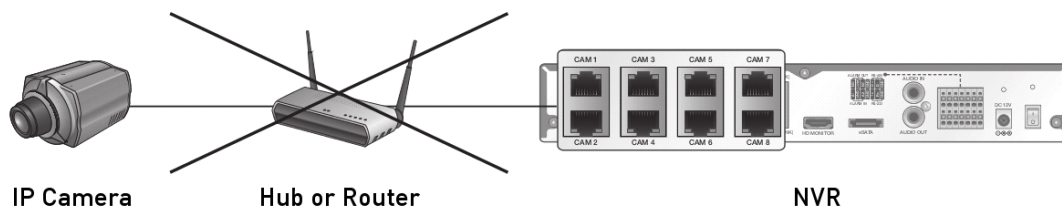

- For stable operation, a dedicated communication line is established for IP cameras in the same network. This is why network router or hub connection is not allowed.

You can connect an IP camera with PoE connection to the rear RJ45 port [[CAM1]~[CAM8]] using the CAT5 10/100Mb Ethernet cable without a separate power source.

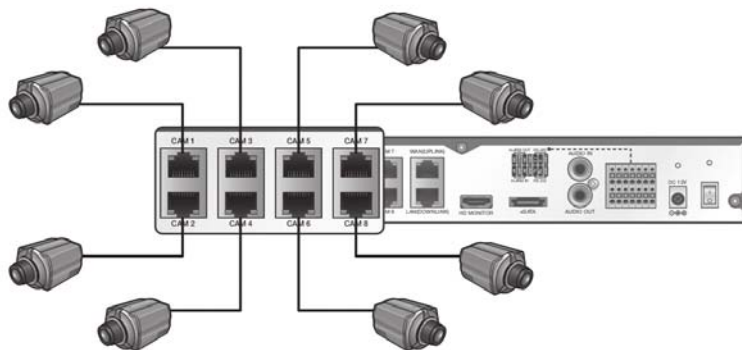

Additional camera connection for GRI-K4416A:

Connect IP cameras to the [CAM9] ~ [CAM16] ports of the hub, and connect the [LAN (DOWNLINK)] port and the hub's [NVR] port with an Ethernet cable to establish the connections for the channels/cameras 9~16.

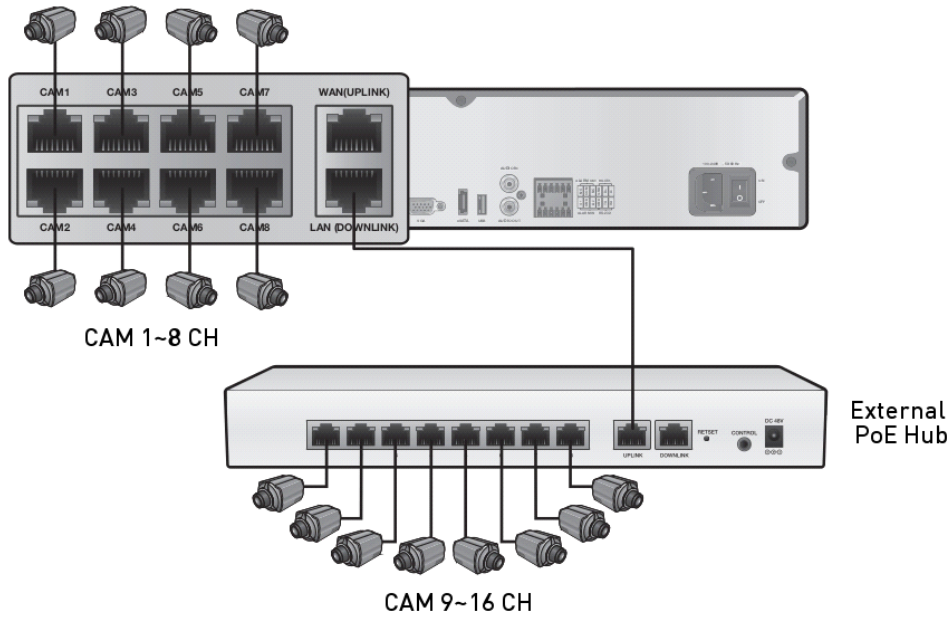

If the distance between the NVR and IP camera is more than 100m:

You may extend the transfer range by connecting a switching hub or PoE device between the Ethernet port of the NVR and of the IP camera if the desired transfer distance is longer than 100m. Connecting cameras directly to a general switching hub requires additional connection of the camera to a separate power supply. A switching hub for extending the transfer range of a single channel should be connected to one camera only.

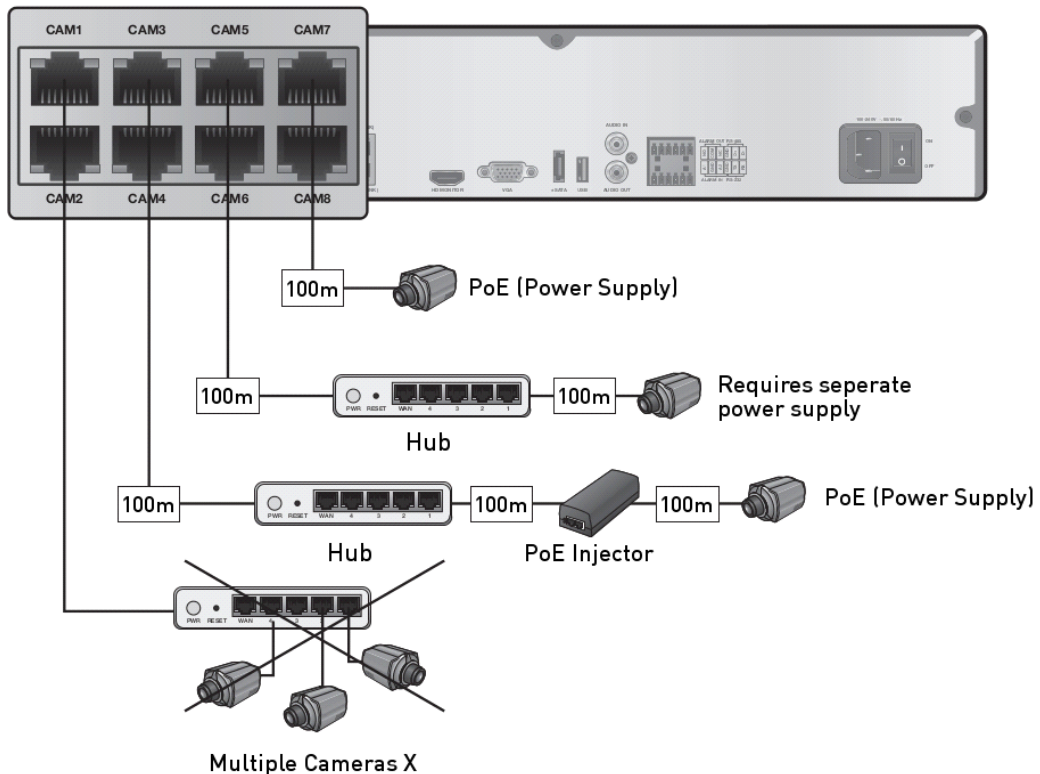

4.4.4. Alarm I/O Connection

Alarm Connection for GRI-K1104A and GRI-K2208A:

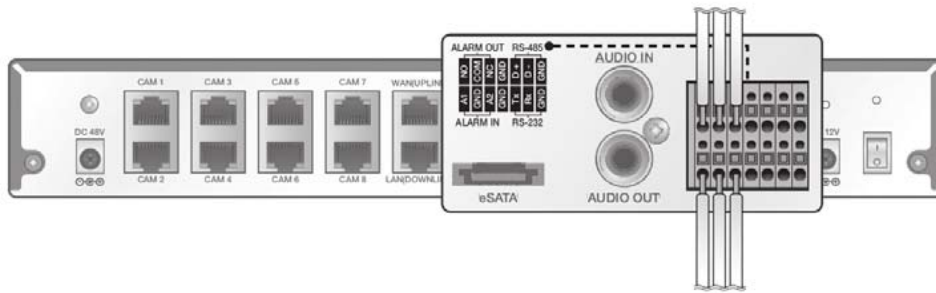

Connecting the alarm input signal :

Connect the signal line of an alarm input device such as a sensor to the rear [ALARM IN] port.

1. While pressing and holding the [A1] or [A2] port button in the rear bottom of the NVR, insert the alarm signal cable into the hole under the button.
2. Insert the grounding wire into the [GND] port.
3. To ensure a secure connection, release the button and try to pull the wire to check if it is firmly seated in the port.
4. To remove the wire, pull it out while holding the upper button.

Connecting the alarm output signal :

Connect the signal line of an alarm output device to the rear [ALARM OUT] port.

1. Check the relay output type of Normal Open or Normal Close before selecting a proper type (N/O or N/C). While holding the [N/O] or [N/C] button, put the alarm signal cable into the hole under the button.

- N/O (Normal Open) : Normally Open but switches to Close if an alarm out occurs.
- GND : Insert the grounding wire.
- N/C (Normal Close) : Normally Close but switches to Open if an alarm out occurs.

2. Insert the grounding wire in the [GND] port.
3. To ensure a secure connection, release the button and pull out the wire to check if it is not pulled out.
4. To remove the wire, pull it out while holding the upper button.

Alarm Connection for GRI-K4416A:

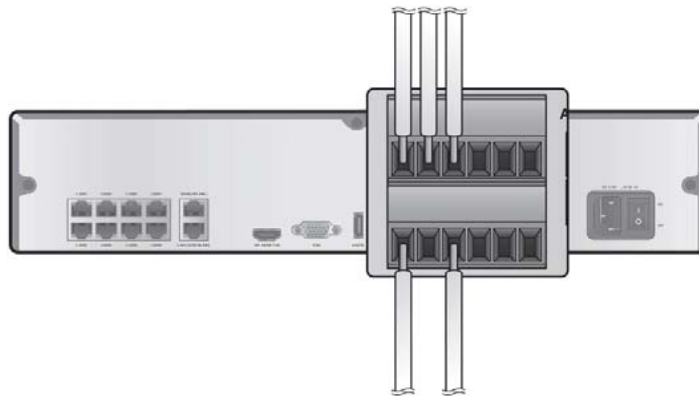

Connecting the alarm input signal :

Connect the signal line of an alarm input device such as a sensor to the rear [ALARM IN] port.

1. Loosen the screws on both the alarm input port and the [GND] port of the provided terminal block plug.

2. Insert one end of the alarm signal cable through the [A1] or [A2] terminal hole below the screw hole, and then fasten the screw.
3. Insert the ground signal wire into the hole of the [GND] port (shown also below the screw), and tighten the screw.
4. To ensure a secure connection, tighten the screw and pull out the wire to check if it is not pulled out. To remove the wire, loosen the screw and pull it out.

Connecting the alarm output signal:

Connect the signal line of an alarm output device to the rear [ALARM OUT] port.

1. Loosen the screws on the [NO] and [NC] ports and the [GND] port of the provided terminal block plug.
2. Insert the alarm signal wire into the hole of the [NO] or [NC] input port (shown below the screw), and tighten the screw. Check the relay output type of Normal Open or Normal Close before selecting a proper type (NO or NC).

> N/O (Normal Open) : Normally Open but switches to Close if an alarm out occurs.

> GND : Insert the grounding wire.

> N/C (Normal Close) : Normally Close but switches to Open if an alarm out occurs.

3. Insert the ground signal wire into the hole of the [GND] port (shown also below the screw), and tighten the screw.
4. To ensure secure connection, tighten the screw and pull out the wire to check if it's not pulled out. To remove the wire, loosen the screw and pull it out.
5. Install the wire-connected terminal block in the rear port.

4.4.5. Communication Ports

Communication Ports of GRI-K1104A and GRI-K2208A:

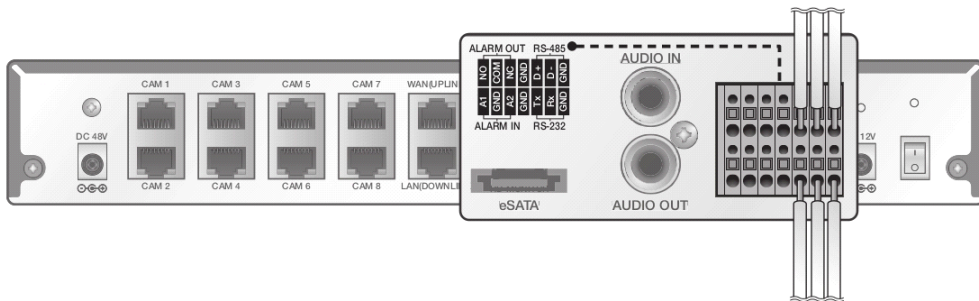

Communication Ports of GRI-K4416A:

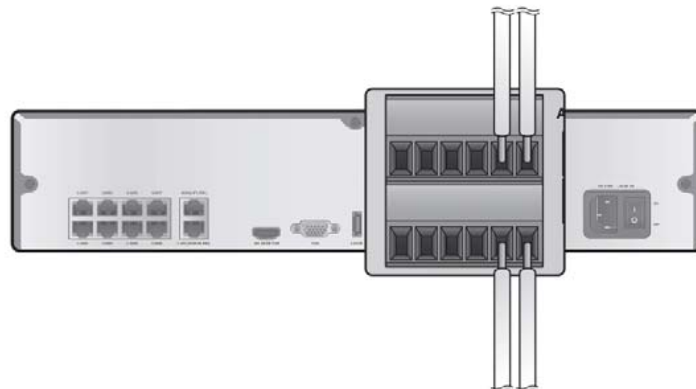

RS-485 Connection :

Connect the keyboard controller. You can connect a text-in device such as POS or ATM. After connecting the control device, be sure to match the connection settings between the NVR and the device. Make the communication settings in the submenu <Control Device> (See chapter 6.7.4. Control Device).

1. Use the signal line to make the connection between [D+] of the rear NVR and [D+] of the keyboard controller.
2. Make the connection between [D-] on the rear of the NVR and [D-] of the keyboard controller.
3. Connect [GND] on the rear of the NVR to [GND] of the keyboard controller.

NOTE: For RS-485 connection, please refer to the user manual of the keyboard controller.
Signal connection for POS and ATM will be integrated later.

RS-232 Connection :

You can connect a text-in device such as POS or ATM. For connection of the text-in device, please refer to the user manual of the text-in device.

NOTE: Signal connection for POS and ATM will be integrated later.

4.4.6. Audio Device Connection

You can connect an audio output device such as a speaker amplifier. Connect the audio input device such as a microphone to the rear Audio In port, connect the audio output device such as a speaker amplifier to the Audio Out port.

4.4.7. eSATA Storage

If the internal storage space is insufficient, you can extend your storage capacity by adding an eSATA storage device to the rear eSATA port.

NOTE: Recording may not be enabled with an incompliant eSATA storage. For the compatibility list, contact the retailer of the eSATA storage.

4.4.8. USB Device

You can connect a USB storage device for saving the video, updating the firmware, importing/exporting user data or settings. You can also connect a USB mouse to control all operations of the NVR.

ATTENTION: If you need to connect a USB HDD with a high power consumption, it is recommended to use a separate power source for that HDD.

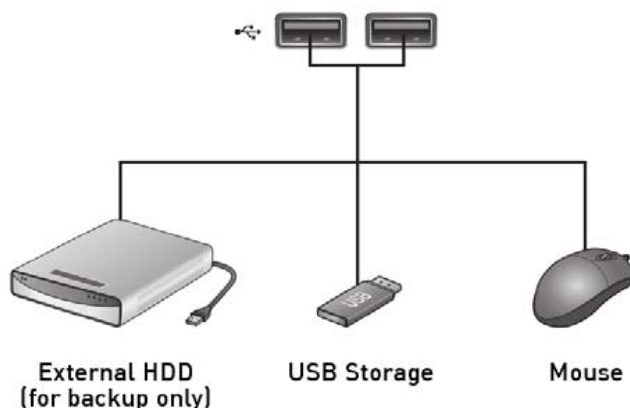

4.4.9. Network Connection

PC connection in the local network :

You can connect an NVR to a PC in the same network and control or edit it on the PC monitor.

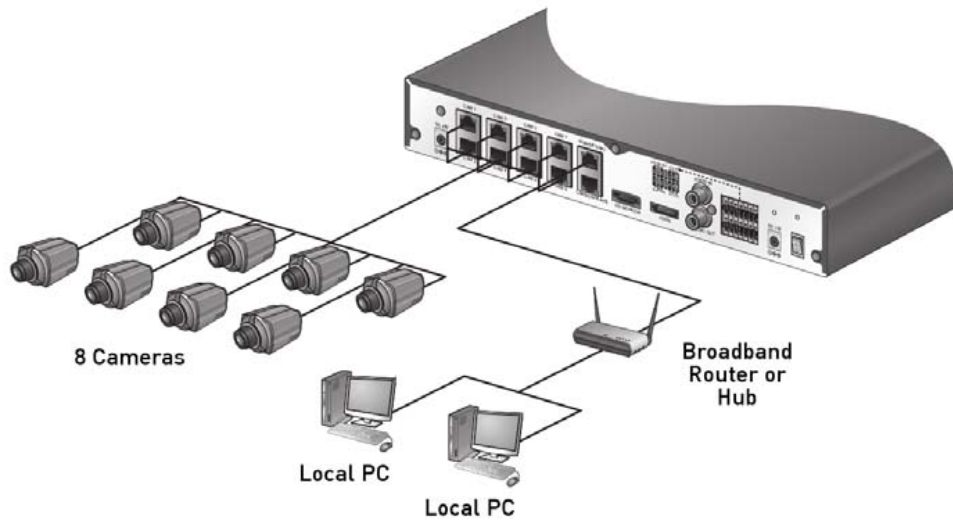

1. Connect the [WAN(UPLINK)] port in the rear panel of the NVR to the router or hub.
2. Connect the local PC to the router or hub.

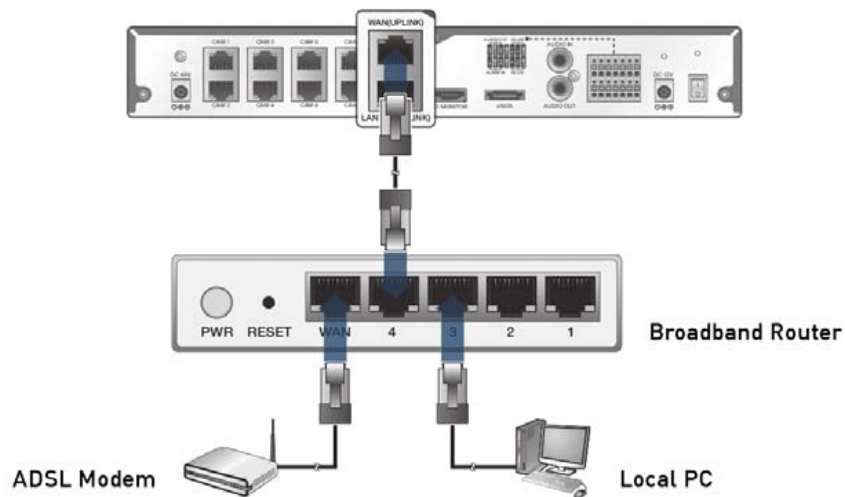

3. Enter the address in the address bar (web browser) of the local PC or of the dedicated software program in the format of "http://IP address:web service port" (Ex : http://192.168.0.23:8080). The web service port is set to 8080 by default. From the Network Setup screen, you can change the port number.

4. Provide the ID and password when logging in. Then, you can view the monitoring screen.
Access ID (factory default) : ADMIN, P/W : 1234.

ATTENTION: For security purposes, change the password right after you purchased the product.

PC connection from a remote network :

You can connect an NVR to a PC or mobile device in the same remote network and control or edit it on the monitor of the PC or mobile device.

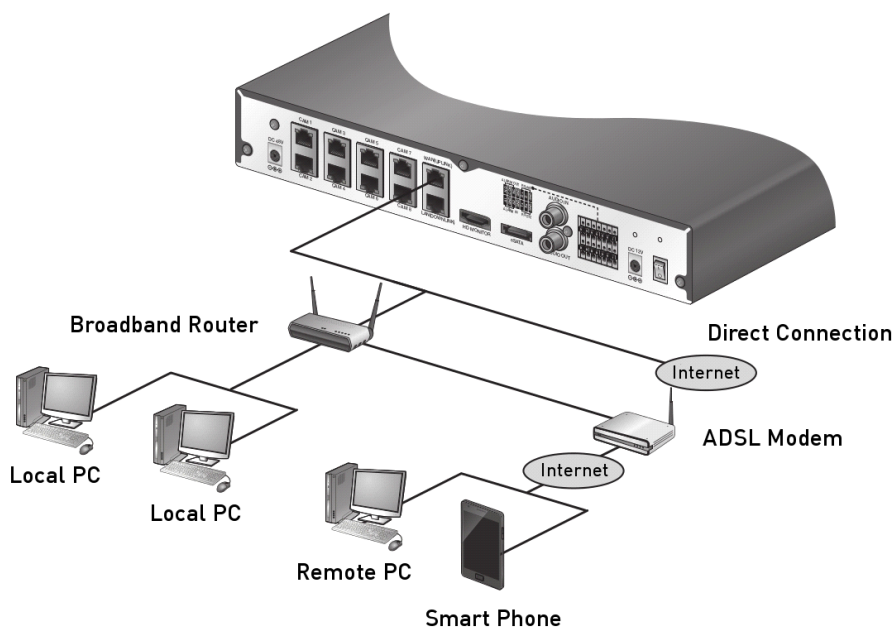

1. Connect the [WAN(UPLINK)] port in the rear panel to the router.

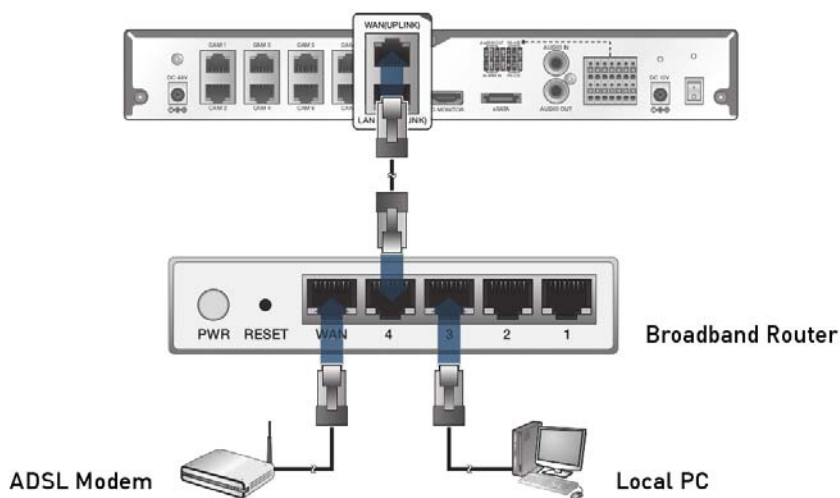

2. Connect the [WAN(UPLINK)] port of the router directly to the fixed IP LAN cable, or connect it to the ADSL modem.

3. If using the router, set the port forwarding and enter the DDNS address in the address bar (web browser) of the remote PC, or of the dedicated software program or mobile phone. For the IP and DDNS address settings, please refer to Chapter 6.6. Network Setup.

4. If the MAC address of the NVR is B8-41-5F-12-34-56 and the web port number is 8080, enter "http://b8415f123456.dvrlink.net:8080" in the address bar of the web browser. If you have renamed DDNS as "mydvr", you can make the network connection at http://mydvr.dvrlink.net:8080.

5. Monitoring

5.1. Start

1. For GRI-K1104A and GRI-K2208A: Connect the adapter to the 48V PoE power input port in the rear panel of the NVR. Connect the adaptor to the 12V power input port in the rear panel of the NVR.

For GRI-K4416A: Connect the adaptor to the power input port in the rear panel of NVR.

ATTENTION: Make the connection when the power is not applied yet.

2. Turn on the power switch on the rear panel of the NVR. First you hear a beep and the LEDs light up. Several seconds after the second beep, the GRUNDIG logo appears on the screen.

3. When the booting process is completed, first the live screen then the login screen appears.

5.2. Login

To edit or access the menu of the NVR, you should have logged in.

1. When the system starts, the login screen appears.

2. Select a user and provide the password. The default password of the "ADMIN" account is "1234".

3. Click <OK>. If the login information is correct and valid, you will see the live screen.

ATTENTION: For security purposes, change the password right after you purchased the product.

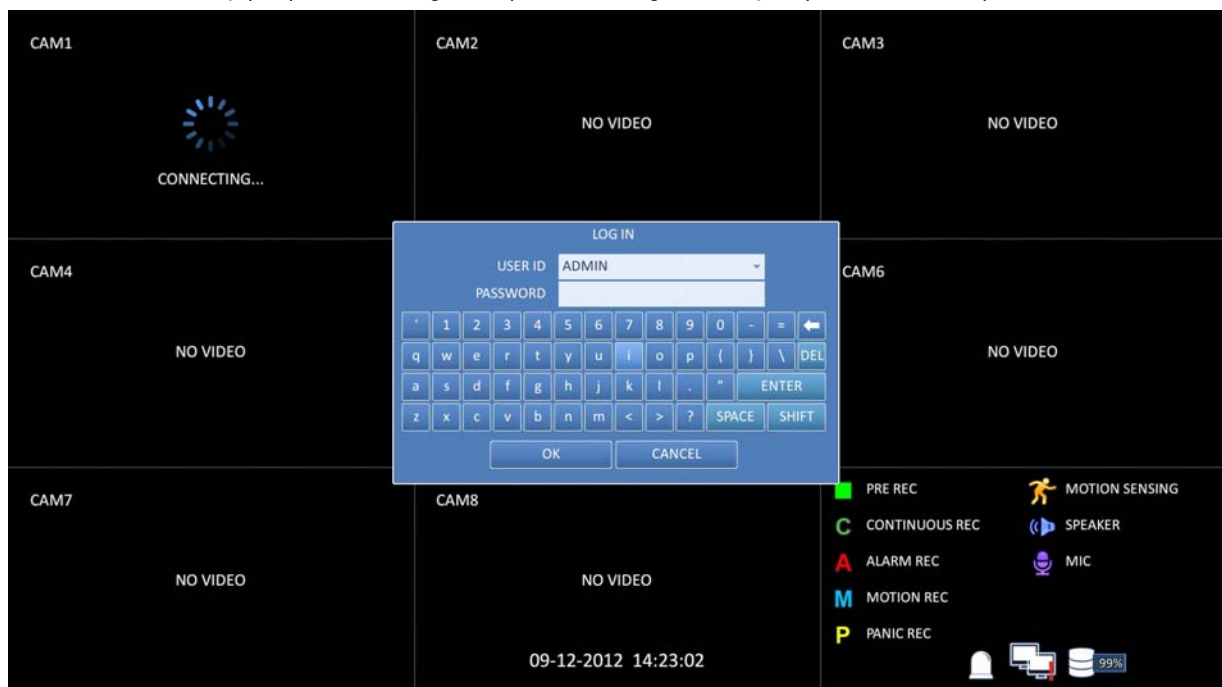

5.3. Logout

To prevent unauthorised access, it is recommended to log out when you leave the screen. Hover the cursor near the bottom of the screen to display the menu.

1. In the monitoring screen, click <MENU> in the bottom left corner of the screen and then click on <LOG OUT> to log out, or press the [LOGOUT] button on the remote control.

2. Access to Search / Backup / System Setup / Record Setup / System Shutdown will be restricted.

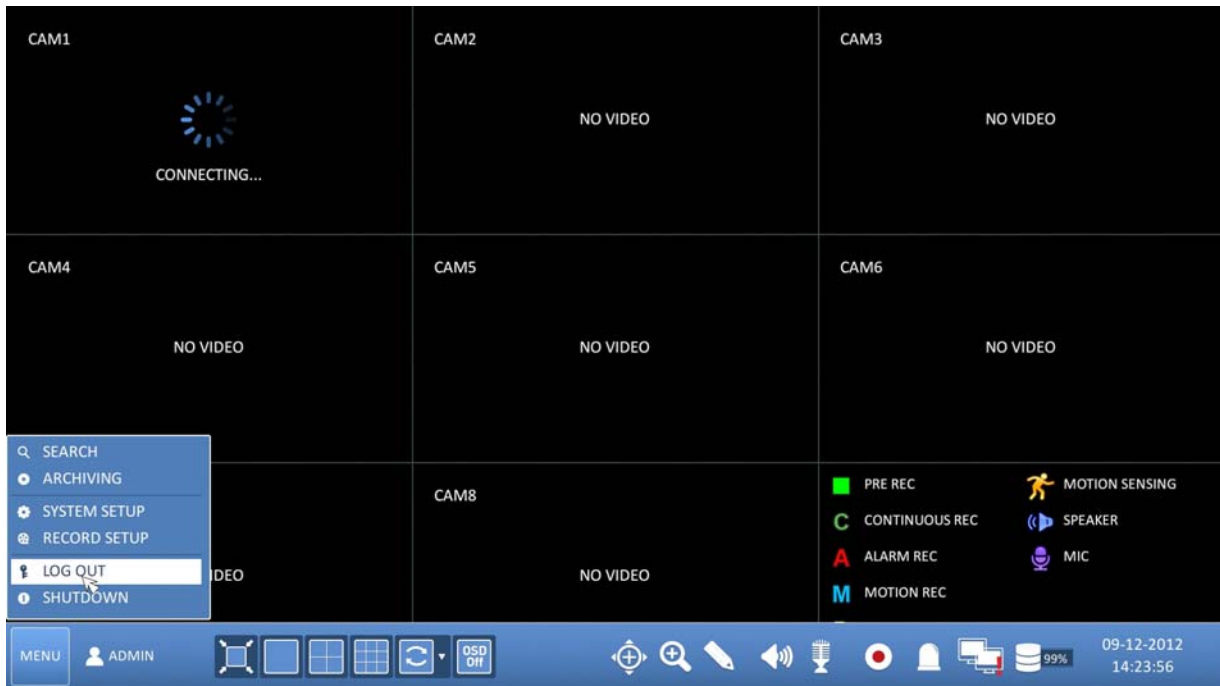

NOTE: Please note that the OSD pictures shown in this manual refer mainly to the 8-channel NVR with the model name GRI-K2208A, therefore 8 frames/channels are mostly shown in the pictures.

5.4. System Shutdown

1. In the monitoring screen, click <Menu> in the bottom left corner of the screen to <SHUTDOWN> the system, or press the [POWER] button on the remote control.
2. Use the virtual keyboard to enter the password.
3. Be sure to turn off the power switch in the rear panel.

ATTENTION: If you turn off the system in an abnormal manner such as removing the power cord while the system is in operation, the disk will have or increase the bad sectors, causing data loss and shortening the life cycle of the disk.

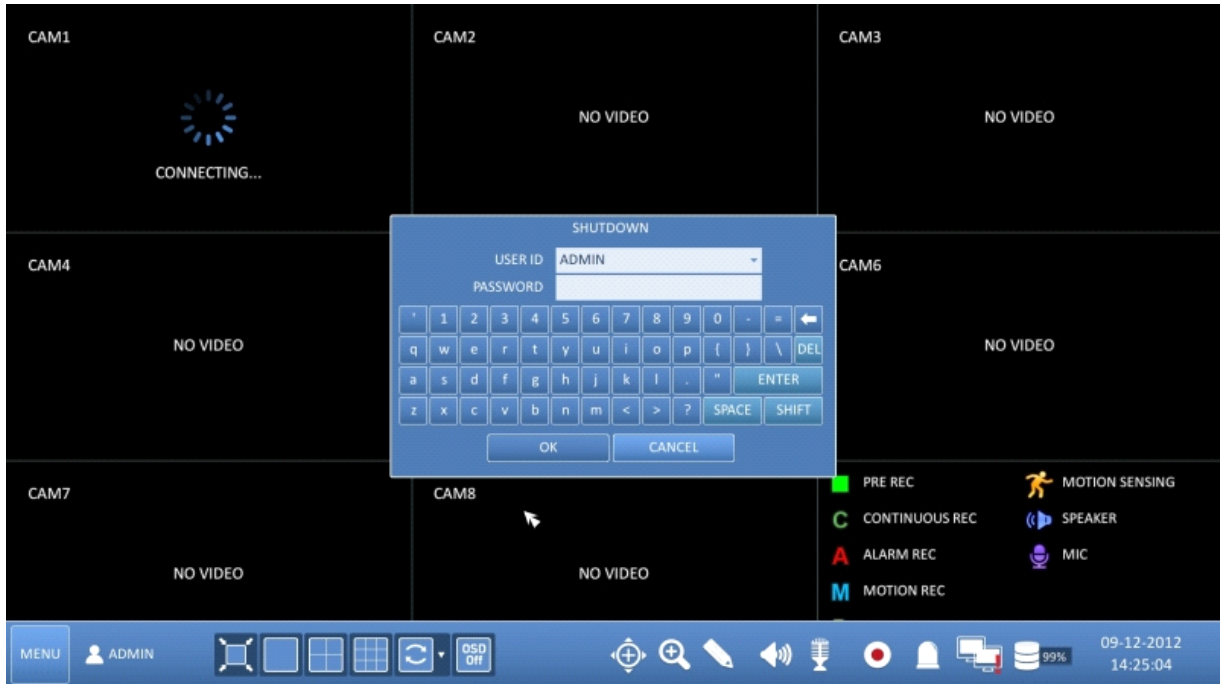

5.5. Live Screen At a Glance

The live screen largely consists of three components: video window, status bar and timeline zone.

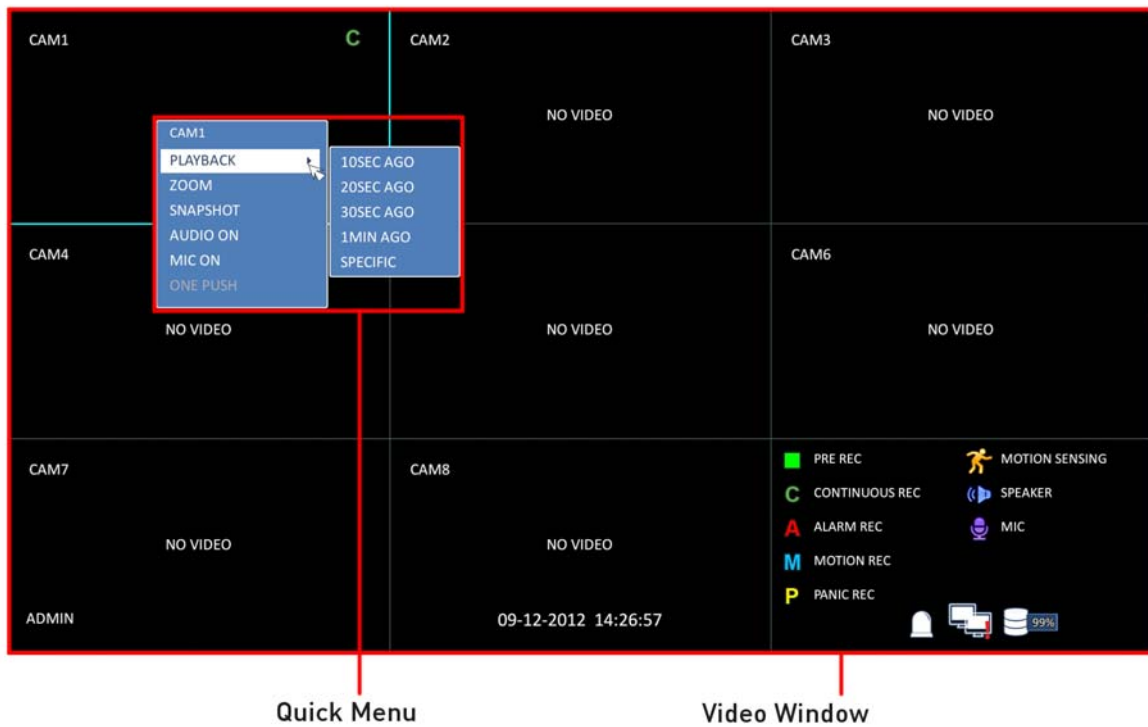











Timeline



Status Bar

5.5.1. Video Window

Icons used in the video window :

















Item		Description
Camera ID		Shows the camera ID.
Record Mode Lens		Displayed if an event recording is reserved.
		Displays the status of the continuous recording.
		Displays the recording status when an alarm occurs.
		Displays the recording status when a motion event occurs.
Audio I/O Icons		Displays the status of the emergency recording.
		The audio signal of the connected camera is outputting.
		The audio signal is transferred to the connected camera via the microphone.
Motion Detection Icon		A motion is detected by the connected camera.

5.5.2. Quick Menu

Item	Description
Channel No.	Displays the number of the current channel.
Play	Start playing the video of the selected channel from the specified time.
Zoom	Zooms in the video of the selected channel.
Snapshot Capture	Captures the current live video and saves it in .jpeg format. Then, you can save the captured video on the HDD or export it to an external USB memory device.
Audio ON/OFF	Turns on or off the audio signal of the selected channel.
Microphone ON/OFF	Turns on or off the microphone signal of the selected channel.



5.5.3. Status Bar

Press the [▼] button on the remote control, or place the mouse cursor in the lower area of the screen to display the status bar.

Item		Description
Menu Button		Select one of the system setup, search and backup menu items before accessing it.
User ID		Shows the ID of the user who has currently logged in.
Screen Control Buttons		Changes the screen layout so that both status bar and timeline are displayed at all times.
		Selects a split mode.
		Selects Auto Sequence or Special Split Mode.
		Displays or hide the OSD menu on the screen
PTZ		Move to the PTZ screen. You can control the PTZ operations of a PTZ-compliant camera on the PTZ screen.
Zoom		Move to the Digital Zoom.
Quick Log		Displays the log list of the recent recording events.
Audio Channel Selection Button		You can use a camera supporting the audio input to listen to the audio.
Microphone Channel Selection Button		Select a camera to which the audio signal will be transferred from the connected microphone.
Panic Record		Start the panic recording.
Alarm Indicator		Turns on if an event occurs. It does not turn on if no reaction to the event is yet defined. Click this to check the information of the event that occurred.
Network Connection Status		Check if a network connection is made via an external PC or mobile device. Click this to view the details of the current users and to check the network connection status. For more information, refer to Chapter 6.6."Network Setup".
Disk Space		Shows the disk space information. If you have set the disk overwrite mode, "OW" will be displayed [Over Write] from the start point of the overwriting. Click this to view the details of the disk status. For more information, please refer to Chapter 7.2."Record Setup".
Date & Time		Displays the current time and date.

5.5.4. Timeline

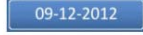
Press the [▶] button on the remote control or move the mouse cursor to the right of the screen to display the timeline. Double-click the timeline to move to the video screen. Drag the cursor on the timeline to mark a certain area in which you want to make the backup or the event search.

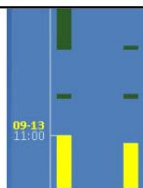
Item		Description
Timeline Date		Displays the date of the current timeline. Click on this to select a desired date of the timeline.
Expand/Collapse the Timeline		Expand or collapse the timeline.
Navigation through Timeline		Navigate through the timeline. You can also use the mouse wheel to do the navigation.
Timeline Bar		Displays the recording data with time. The colour of each bar indicates the following: <ul style="list-style-type: none"> - Green : Continuous Recording - Red : Alarm Recording - Blue : Motion Recording - Yellow: Panic Recording

5.5.5. Using the Status Bar in Live Mode

Selecting a split mode :

Click a desired split mode from 1, 4, 9, 16, 6 and 8 split screen. Or press the [DISPLAY] button on the remote control until a desired split mode is displayed.

NOTE: The 4CH NVR model GRI-K1104A only supports 1- and 4-split screen modes. The 8CH NVR model GRI-K2208A only supports 1-, 4-, 9-, 6- and 8-split screen modes.

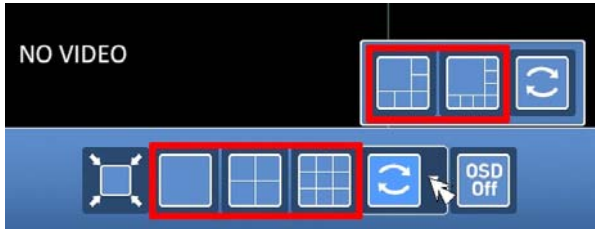

Auto sequence :

Click on the Sequence button in the status bar, or press the [SEQ] button on the remote control to perform the specified sequence mode. You can configure the sequence settings under the menu item <SEQUENCE>. For details, please refer to Chapter 6.6.3. Sequence.



Controlling the PTZ :

You can control the PTZ cameras that are connected to the channels. Use the mouse to click on the PTZ button on the status bar, or press the [PTZ] button of the remote control to initiate the predefined sequence. In PTZ mode, use the buttons on the screen to control the PTZ or use the [ZOOM], [FOCUS] and [PRESET] buttons of the remote control.



A screenshot of the PTZ control interface. The interface is divided into several sections:

- PRESET Table:** A table with columns 'NO.' and 'NAME'. The first row contains '1' and 'PRESET 1'. Below the table is a 'SET' button.
- SCAN / TOUR Section:** A dropdown menu set to 'TOUR' and a 'TOUR' button. A red arrow points to it with the label 'SCAN/TOUR Settings'.
- Navigation Buttons:** A set of directional arrows (up, down, left, right, home) and a 'PROPERTY' button. A red arrow points to them with the label 'Move'.
- Adjustment Buttons:** Buttons for 'ZOOM', 'FOCUS', and 'IRIS', along with a 'ONE PUSH FOCUS' button. A red arrow points to them with the label 'Zoom/Focus/Iris Adjustment'.
- Record/Mic Section:** A 'RECORD STATUS' section with a grid of 16 numbered buttons (1-16). Below it are 'ALARM IN (CAMERA)', 'ALARM IN (DVR)', 'ALARM OUT (CAMERA)', and 'ALARM OUT (DVR)' sections, each with numbered buttons. A red arrow points to the microphone icon with the label 'Record/Mic'.
- Annotations:** A red arrow points to the 'PRESET 1' button with the label 'Select Preset'.

Pan/Tilt Control :

Use the mouse to rotate the PTZ camera in the directions Up/Down/Left/Right and Diagonal. You can control the Pan/Tilt with the [▲▼◀▶] buttons of the remote control.



Zoom / Focus Control :

You can adjust the PTZ camera's zoom and focus. Click on the <ONE PUSH FOCUS> button to adjust the camera's focus automatically. If the connected camera supports manual iris adjustment, you can adjust the iris setting. You can also control the zoom and focus by using the [ZOOM] and [FOCUS] buttons of the remote control.

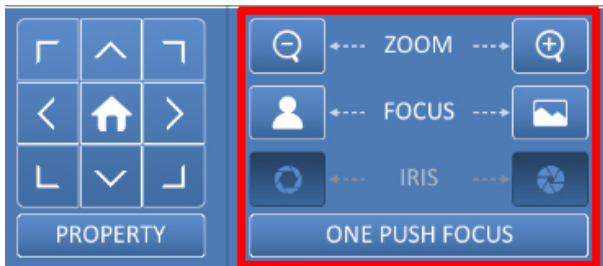

1. Click on <PROPERTY> and change the desired settings of the PTZ camera (auto focus, auto IRIS, pan/tilt speed, zoom speed, focusing speed, iris speed).

NOTE: Depending on the PTZ camera manufacturer and model, some of the PTZ properties may not be applicable.

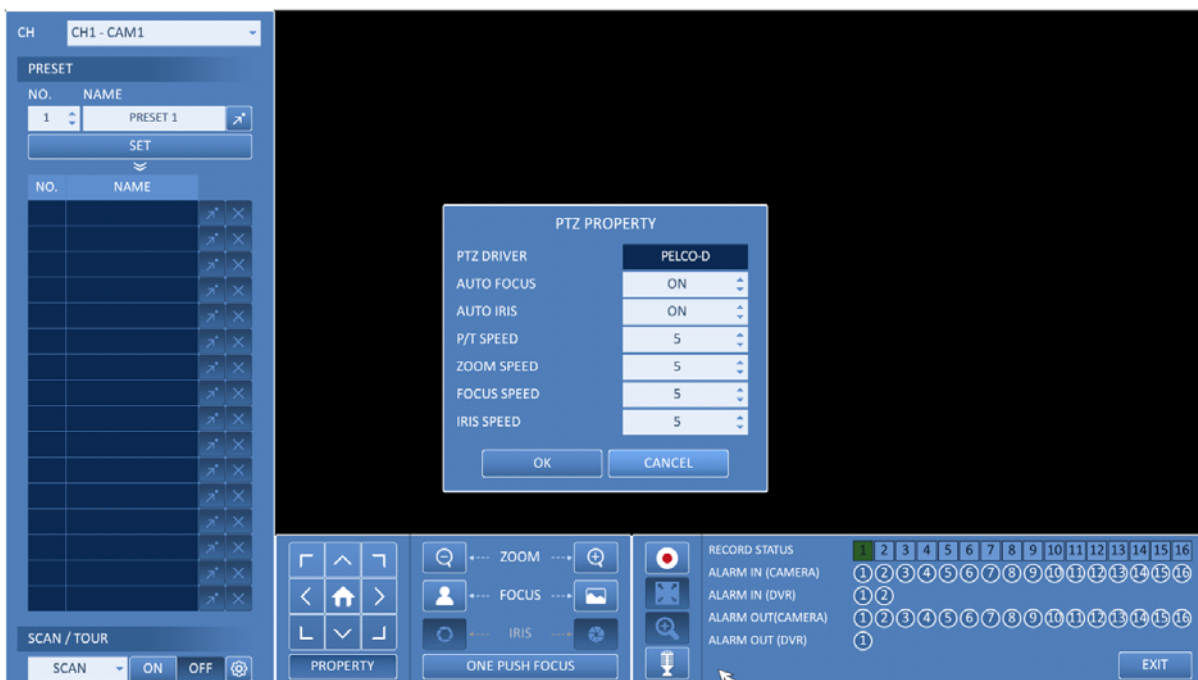

- > CH : Selects the PTZ camera connected to the NVR.
- > PRESET (No. / Name) : You can select the preset number and name.

NOTE: Up to 255 presets can be selected for a PTZ camera, while up to 16 presets can be registered to one NVR.

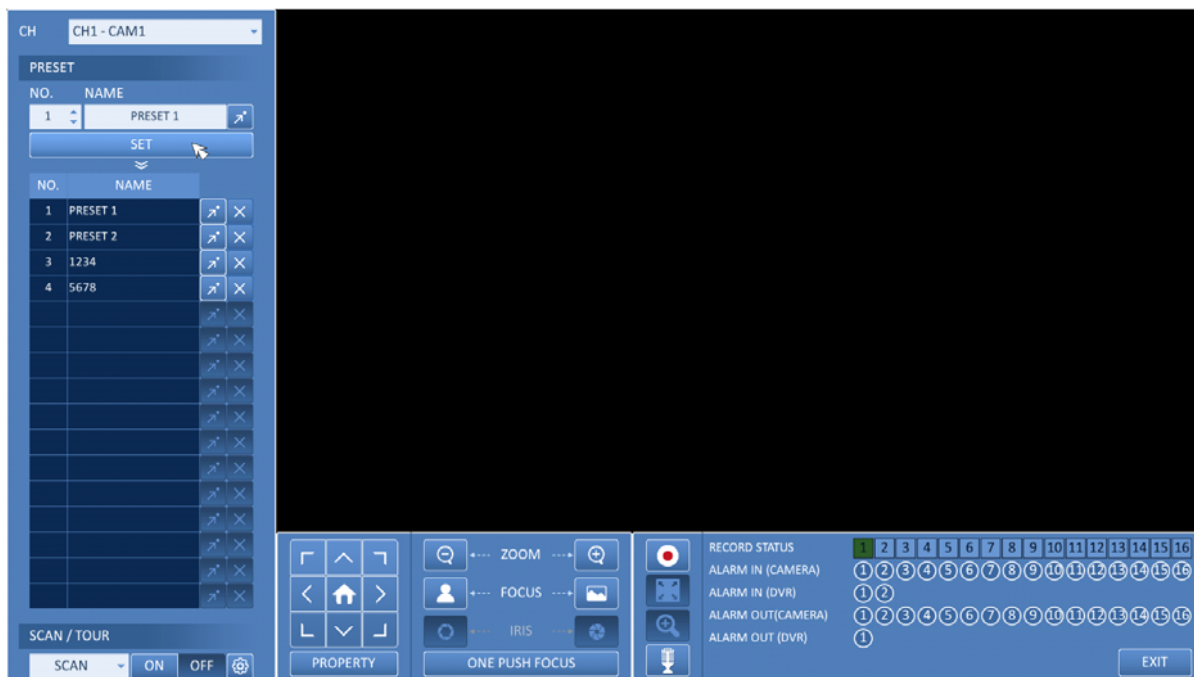

- Control the Camera's PTZ while watching the video. Press the <SET> button to append the preset.
 - > Click the shortcut icon to move to the corresponding PTZ (preset) position.
 - > Click on the Delete icon to delete the corresponding preset.

NOTE: PRESET memorises the PTZ camera's framing for direct access to the same framing at a later time.

SCAN/TOUR:

- Select <SCAN> and click the <ON> button.
- Click on the <Cogwheel> button.

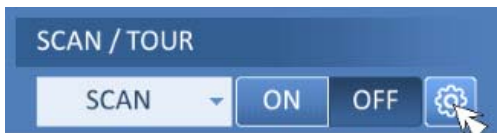

3. Select a user-defined preset and register it.

> DWELL : Sets the dwell time of 00 seconds before moving to the next preset location.

NOTE: The <SCAN> function patrols between two preset positions at the specified speed and interval for back-and-forth monitoring.

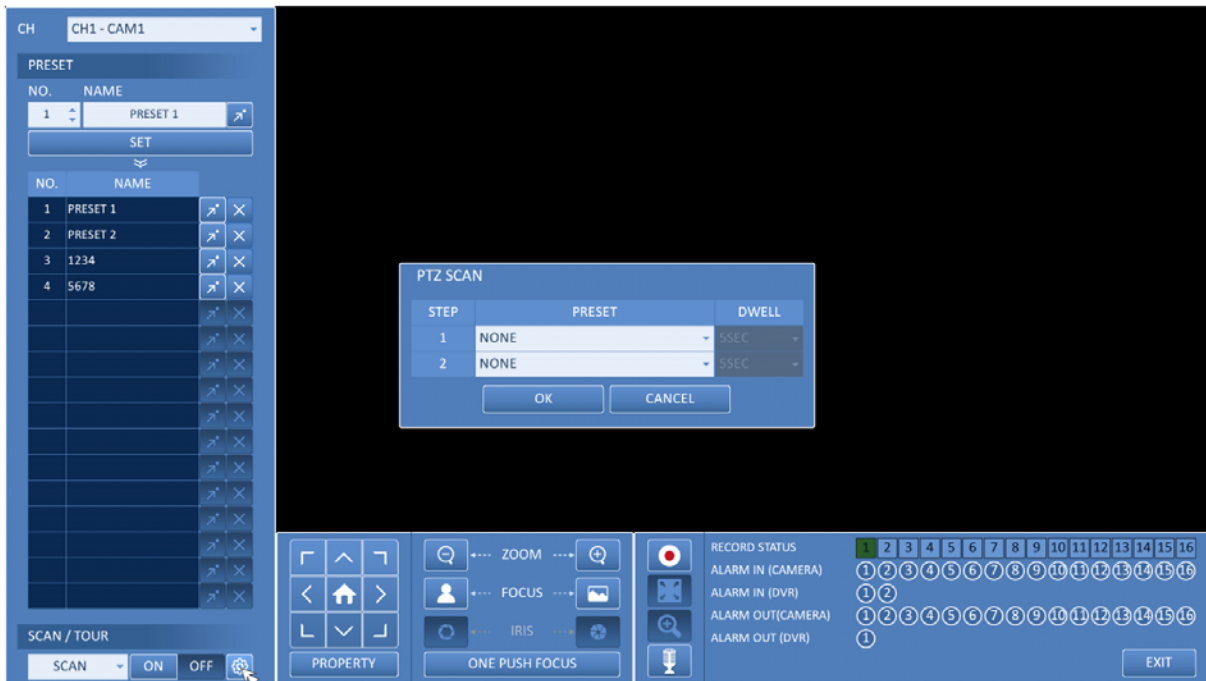

4. Select <TOUR> and click on the <ON> button.

5. Click on the <Cogwheel> button.

6. Select a user-defined preset and register it.

> DWELL: Sets the dwell time of 00 seconds before moving to the next preset location.

NOTE: The <TOUR> function patrols between multiple presets in order (PRESET 1 > PRESET 2 > PRESET 3 >...) for automated patrol monitoring.

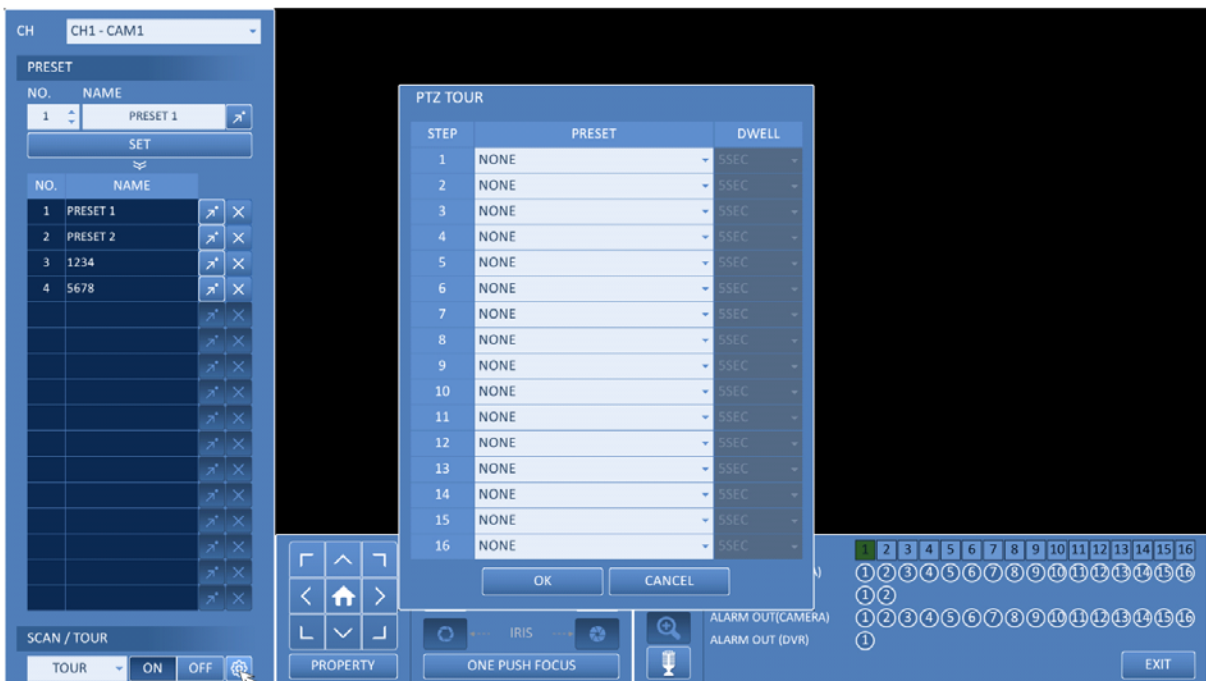

Digital Zooming :

You can enlarge the monitoring screen for a better view. Zooming will enlarge the video of the selected channel. If no channel is selected, channel 1 will be zoomed in.

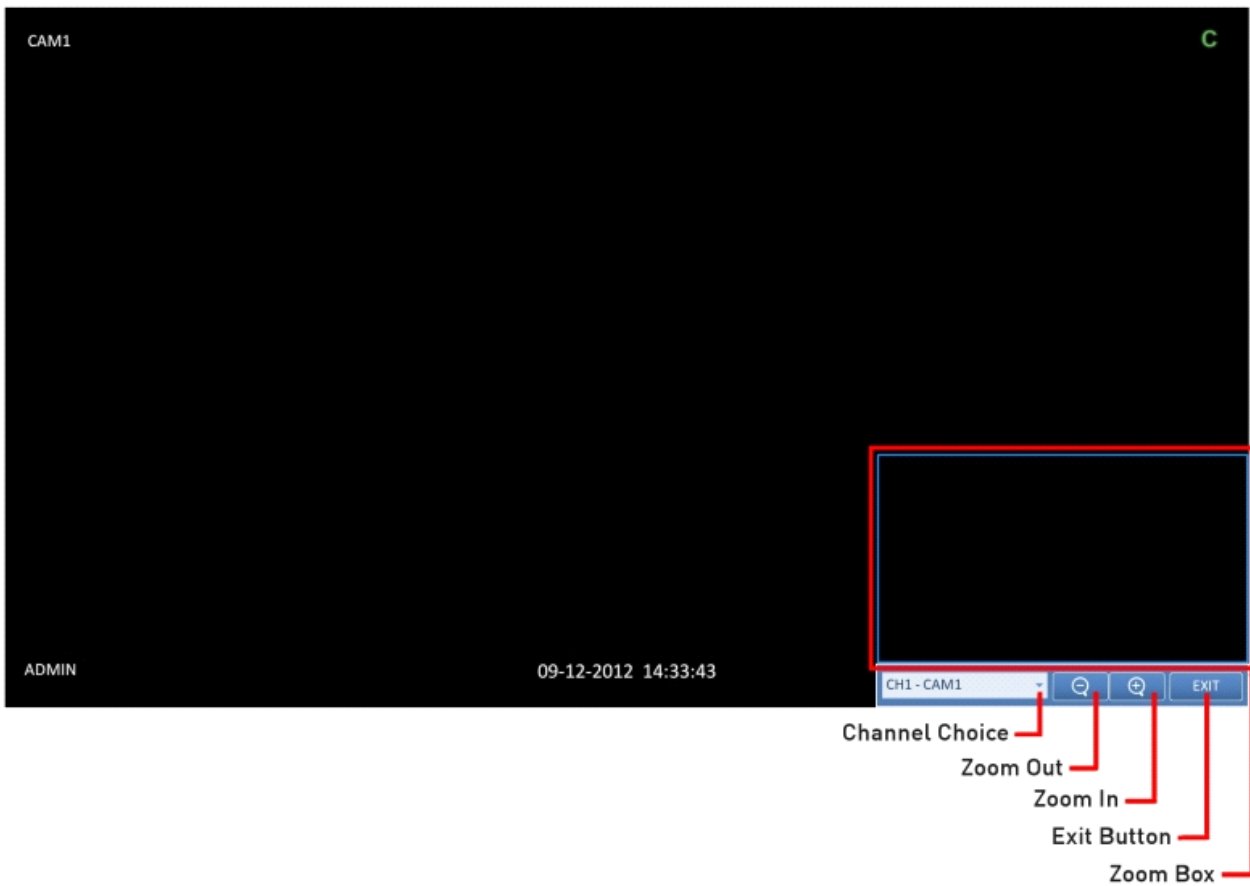

1. Click on <Zoom> in the status bar or move the cursor to a desired channel and right-click on it to display the context menu. Select <ZOOM>. You can also press the [ZOOM] button on the remote control.

2. Move to the zoom control screen. When the menu bar appears in the right bottom, use the buttons to control the zooming.

- Channel Choice : Select a channel to zoom in/out.
- Zoom Out : Zoom out the current (enlarged) image step by step.
- Zoom In : Enlarge the current image step by step.
- Zoom Box : Use the blue box to move to or select a desired zooming area.
- Exit Button : Exit the zooming screen and return to the live screen.

How to check the event log :

You can check the log of the events that occurred.

1. Click on the <Log> symbol (please refer to the picture) to display the “EVENT LOG” window. The log list is sorted with the latest one on top.
2. Double-click on a desired log to playback the event video in the playback screen.

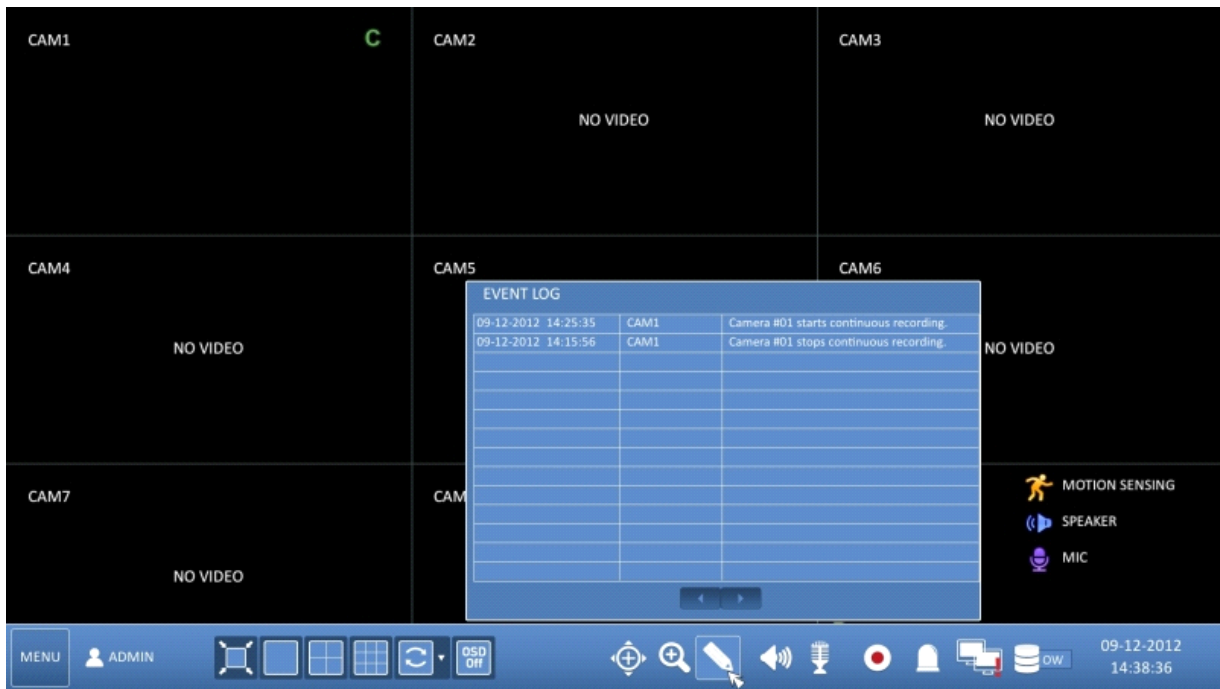

How to select an audio input channel :

Select a channel from which the audio signal will be received.

> CH : Produces the selected channel’s audio, regardless of the split screen mode.

> LINK TO FULL SCREEN : When switching the DVR display mode to view one channel (Single Split), the selected channel’s audio is produced.

NOTE: A camera that supports audio input needs to be used, and the DVR needs to be connected to a speaker.

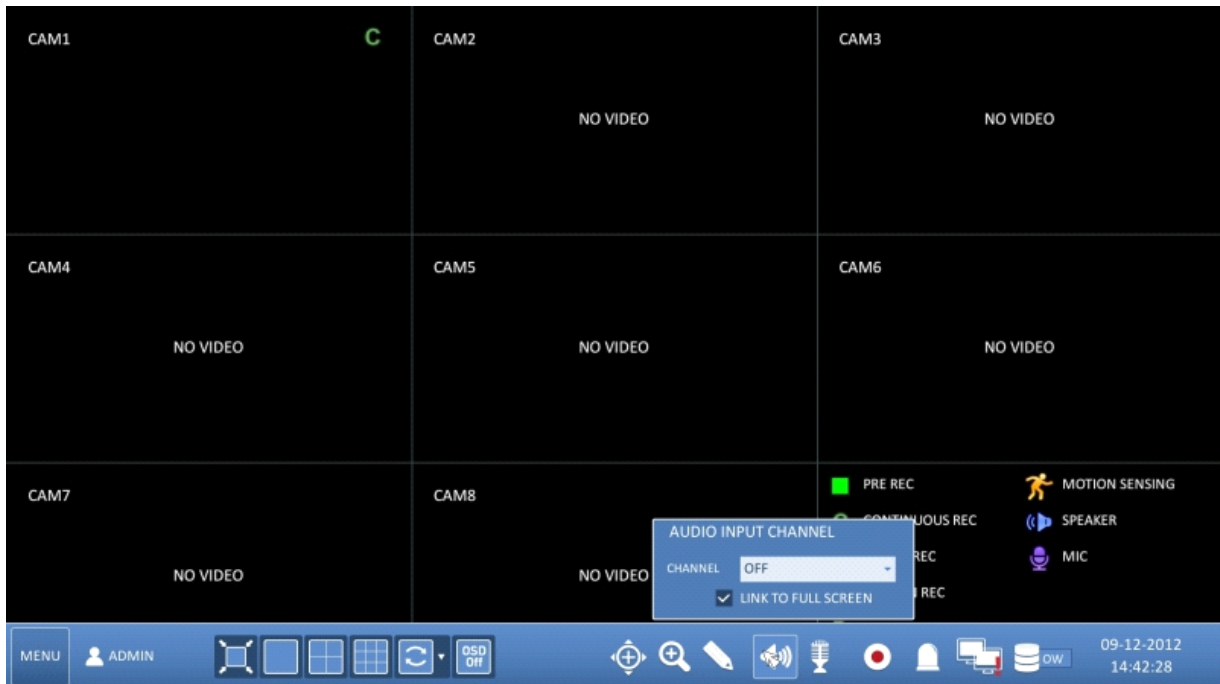

How to select an audio output channel :

You can select a camera outputting the voice signal from the microphone that is connected to the NVR.



How to check the alarm status :

You can check here the alarm status of each camera. Click on <OK> to close the window.

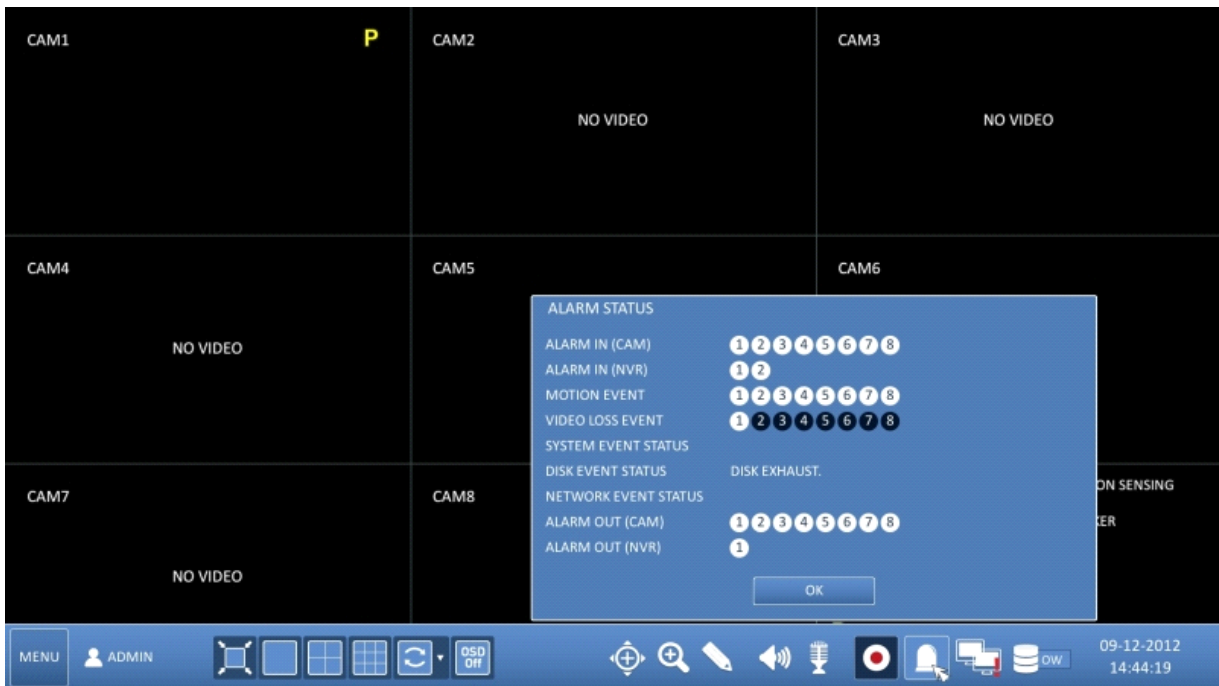

How to check the network status :

You can check here the network connection status. Click on <OK> to close the window.

NOTE: For more information, please refer to Chapter 6.6.4. Network Status.

How to check the disk status :

You can check here the storage space of the current disk and you can check also if there is any problem with the disk. Click on <OK> to close the window.

NOTE: For more information, please refer to Chapter 6.8.1. Disk Information).



Saving captured snapshots :

You can capture the current video screen and save or export to a connected storage device.

1. Select a channel first, and right-click to open the pop-up menu. Then select the <SNAPSHOT> menu item, or press the [SNAPSHOT] button of the remote control.

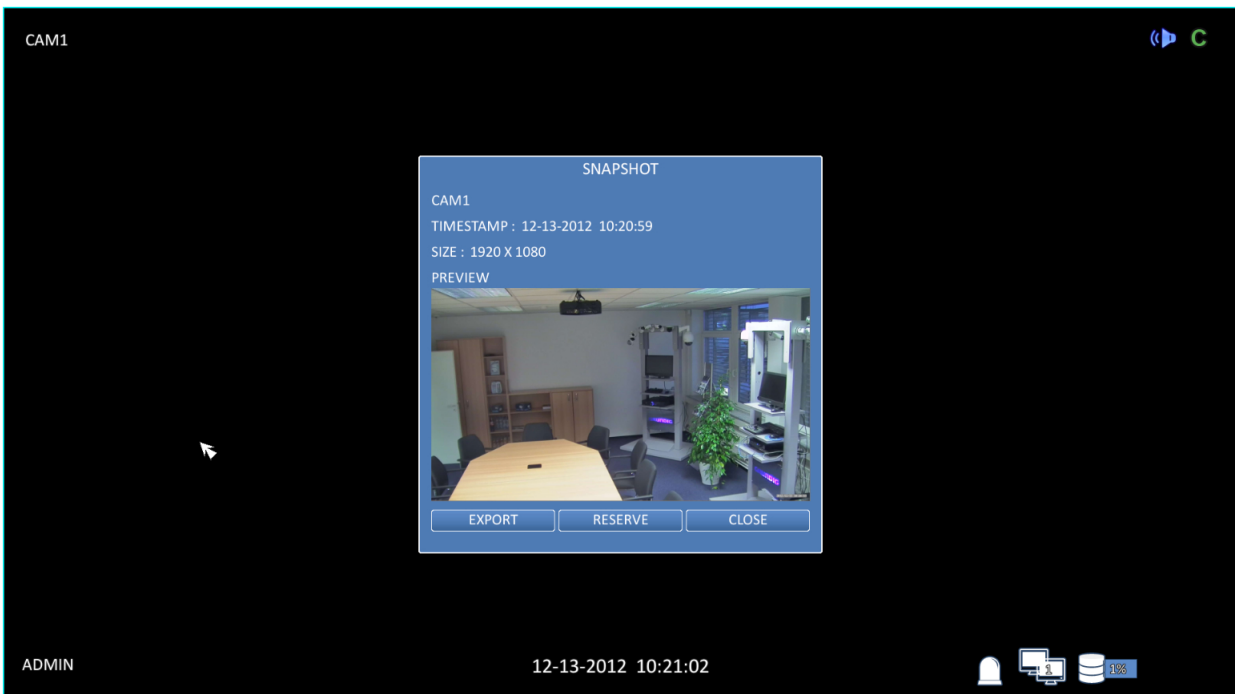

2. Connect a storage device, and click on the <EXPORT> button. To save the captured image onto the built-in HDD, press the <RESERVE> button.

NOTE: The saved image can be found under “Archiving > Reserved data management” and can then be backed up.

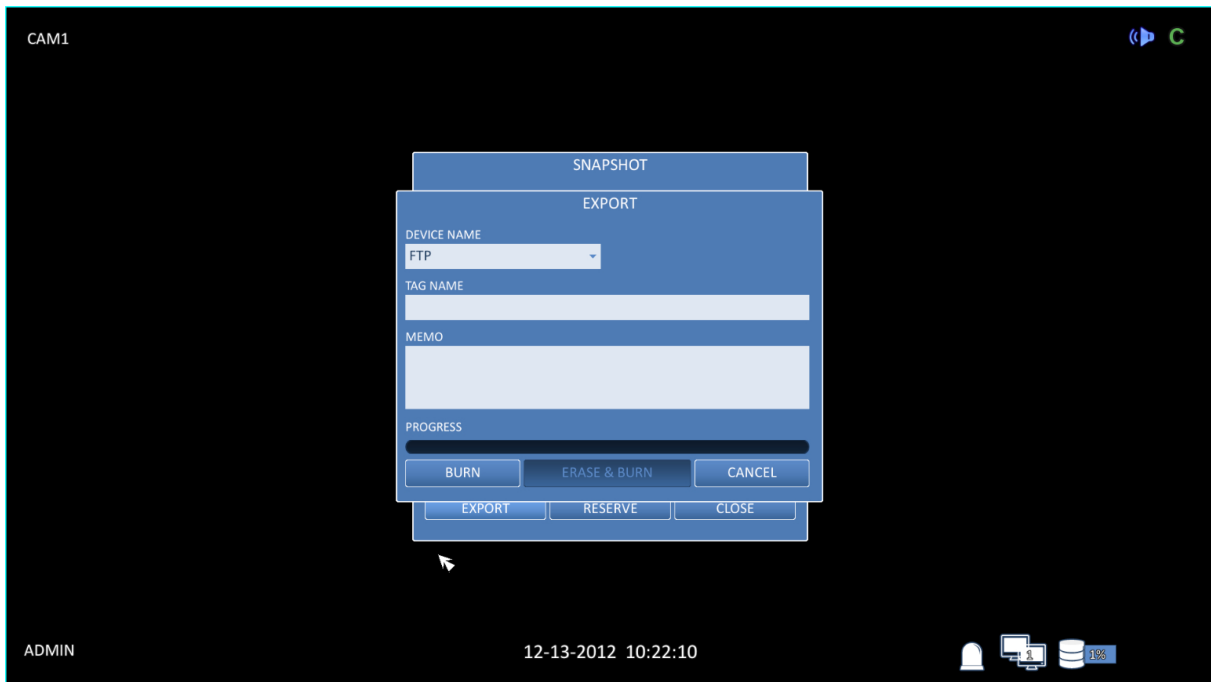

3. Enter the <TAG NAME> and the <MEMO> and press the <BURN> or <ERASE & BURN> button.

- > A progress bar appears and indicates the progress of the export to a storage device.
- > BURN : The snapshot is stored in the connected USB storage device.
- > ERASE & BURN : Deletes all files in the connected USB storage and then saves the snapshot.

ATTENTION: Note that the <ERASE & BURN> option erases all data in the USB storage device and will not be restored again once deleted.

6. System Setting

Please note that the OSD pictures shown in this manual refer mainly to the 8-channel NVR with the model name GRI-K2208A, therefore 8 frames/channels are mostly shown in the pictures.

6.1. Moving To The System Setup

> How to use the mouse :



> How to use the remote control (1) :



> How to use the remote control (2) :



6.2. Camera Setting

You can configure the camera settings in the NVR menu regarding the camera ID, image, hide/show, and motion.

6.2.1. Camera Title

You can change the camera ID that is displayed on the screen like explained in the following:

1. From <SYSTEM SETUP> - <CAMERA>, select <CAMERA TITLE>.
2. Use the [▲▼◀▶/ENTER] buttons on the remote control or use the mouse to select a channel that you want to rename. Alternatively, simply double-click on the camera name to rename from the top left corner.

NOTE: Allows input of up to 8 bytes of alphanumeric characters.

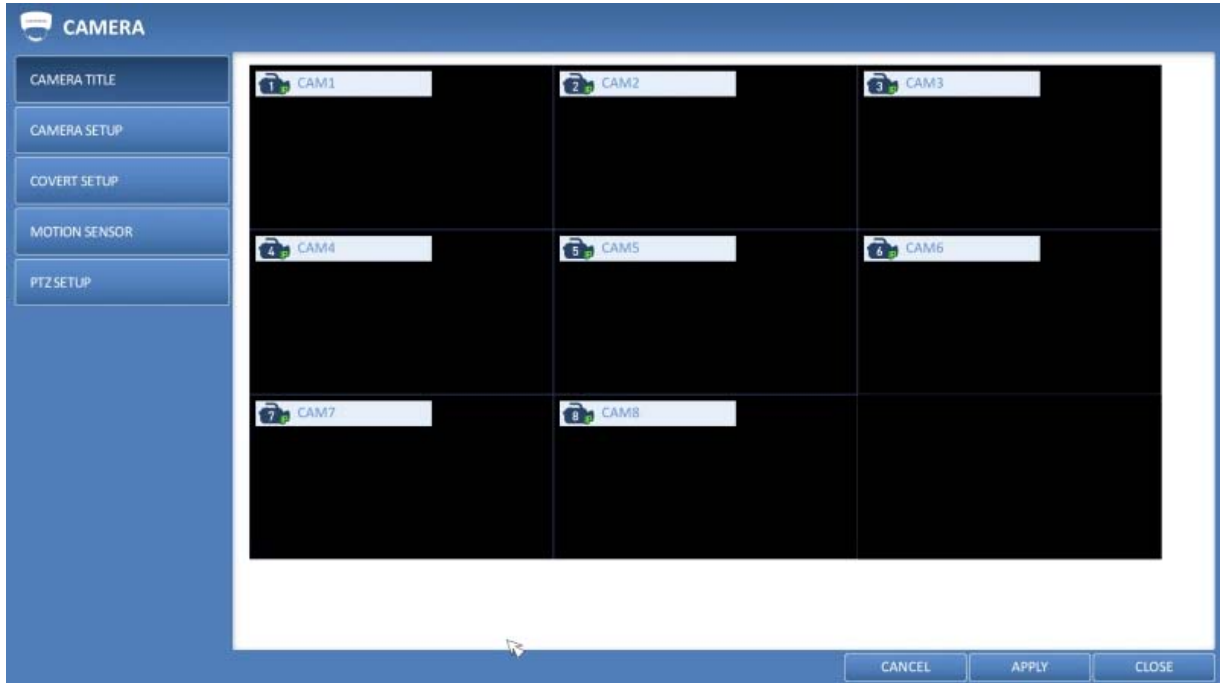

3. With the virtual keyboard that appears, enter a camera title and click on <OK>.

4. To apply the change, click <APPLY> in the bottom of the screen.

5. When done, press the [EXIT] button on the remote control or click on <CLOSE> in the lower screen. The confirmation message appears and you will return to the previous menu.

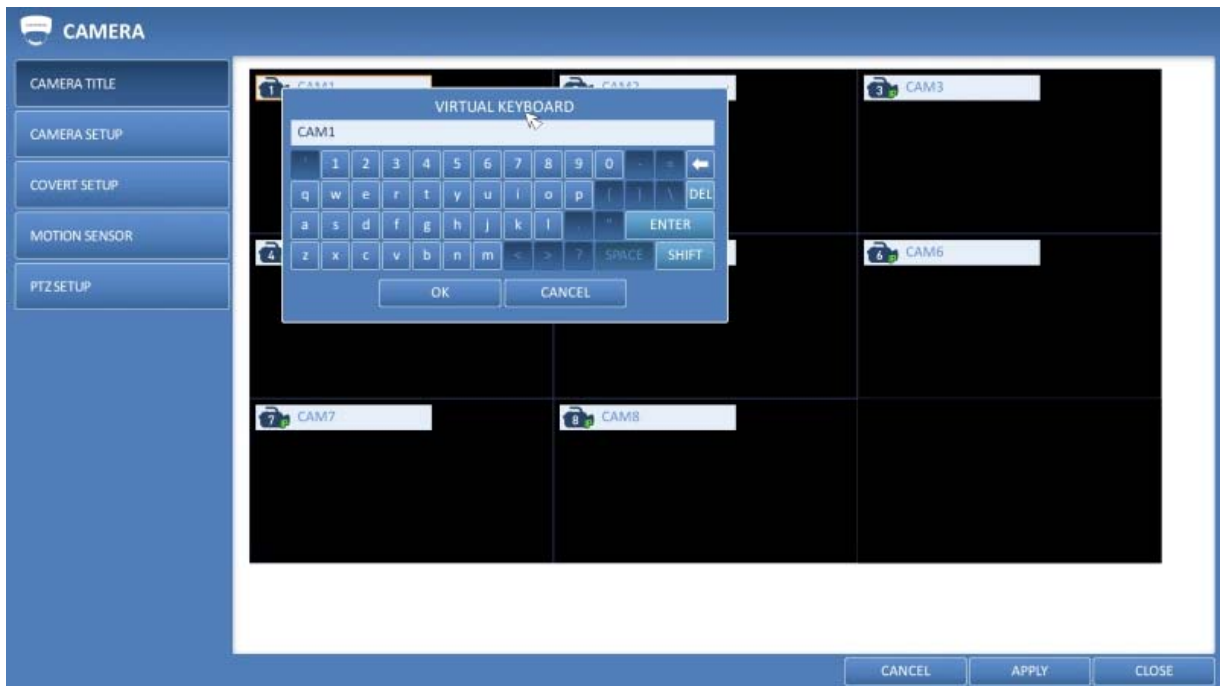

6.2.2. Camera Setup

Adjust the Image & Exposure settings for each camera according to your preference.

1. From <SYSTEM SETUP> - <CAMERA>, select <CAMERA SETUP>.
2. Use the [▲▼◀▶/ENTER] buttons on the remote control or use the mouse to set each option of the Image menu.

ATTENTION: The camera setting items may differ depending on the camera model.

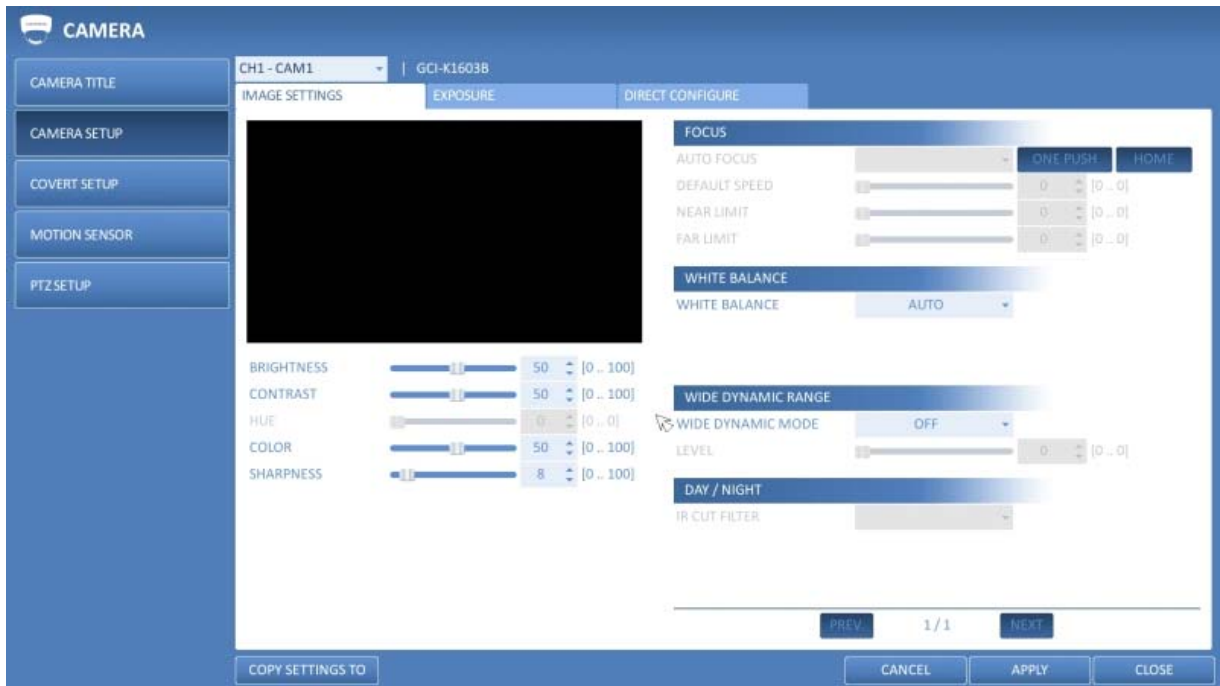

IMAGE SETTINGS:

- BRIGHTNESS: Adjust the brightness level of the camera between 0 and 100.
- CONTRAST: Adjust the contrast level of the camera between 0 and 100.
- HUE / TINT: The Hue value is not supported by ONVIF command at the moment, please use the direct configuration tab to adjust the Hue value if you need it.
- COLOUR: Adjust the saturation level of the camera between 0 and 100.
- SHARPNESS: Adjust the sharpness level of the camera between 0 and 100. This will increase the digital sharpening of the camera.

> FOCUS:

- AUTO FOCUS: If the Camera has a motorised lens, you can adjust the way the zoom lens works here.

> WHITE BALANCE:

- WHITE BALANCE: To display natural colours, the camera needs to know the reference colour temperature of the light source. Based on this reference colour temperature the camera will calculate the correct values for all colours. The camera can perform a measurement by itself or the user can set up the reference colour temperature manually.

> WIDE DYNAMIC RANGE:

- WIDE DYNAMIC MODE: Activate the WDR function of the camera to compensate strong backlight situations.

> DAY/NIGHT:

- IR CUT FILTER: Select AUTO to activate the automatic switch between Day and Night (B&W mode) of the camera. Select OFF to keep the camera always in Day mode. Select ON to switch manually to Night mode.

3. Click on <EXPOSURE> tab and configure the Exposure settings in detail for each camera as necessary.

ATTENTION: The exposure setting items may differ depending on the camera model.

4. To apply the change, click <APPLY> in the bottom of the screen.

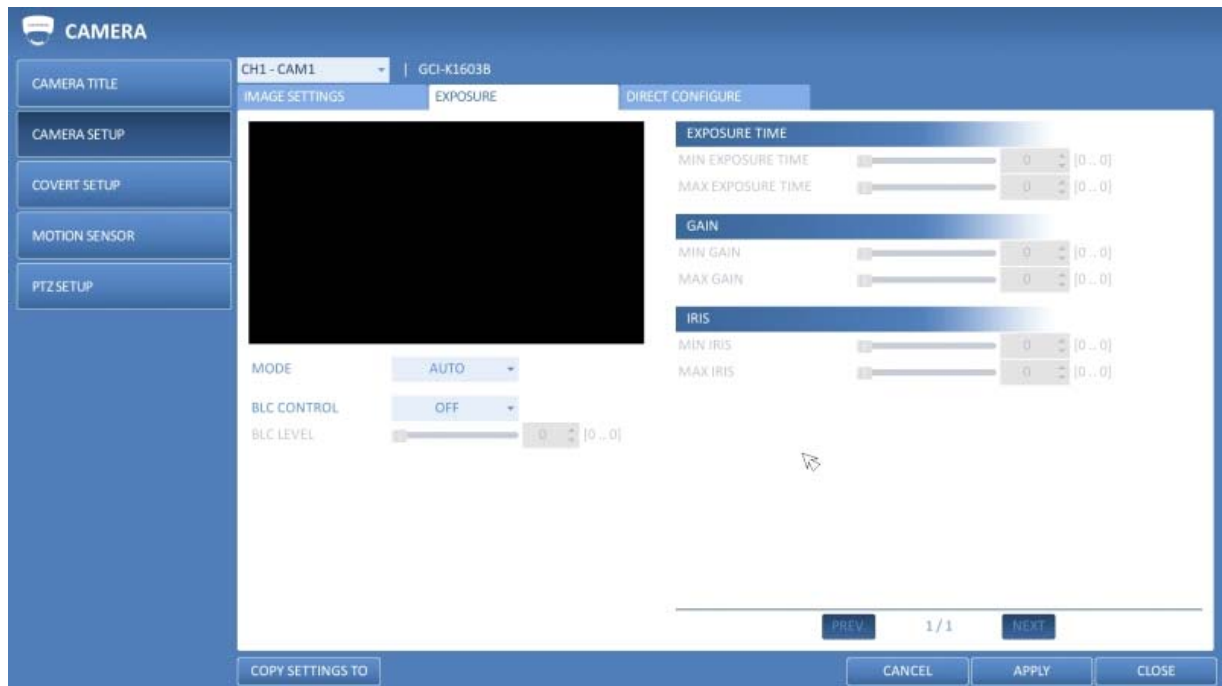

EXPOSURE:

- MODE: Select between manual and automatic configuration for the exposure settings.
- BLC CONTROL: Activate or deactivate the backlight compensation control. In strong backlight situations this might improve the picture quality.

> EXPOSURE TIME: Set the maximum and minimum possible exposure time the camera will use.

> GAIN: Set the maximum and minimum possible gain time the camera will use to increase the brightness level of the image.

> IRIS: Set the maximum and minimum possible iris level the camera will use to increase the brightness level of the image.

DIRECT ACCESS:

In the direct configure tab you can activate the port forwarding of a dedicated camera. This will allow you to access the camera webinterface through the IP address of the NVR.

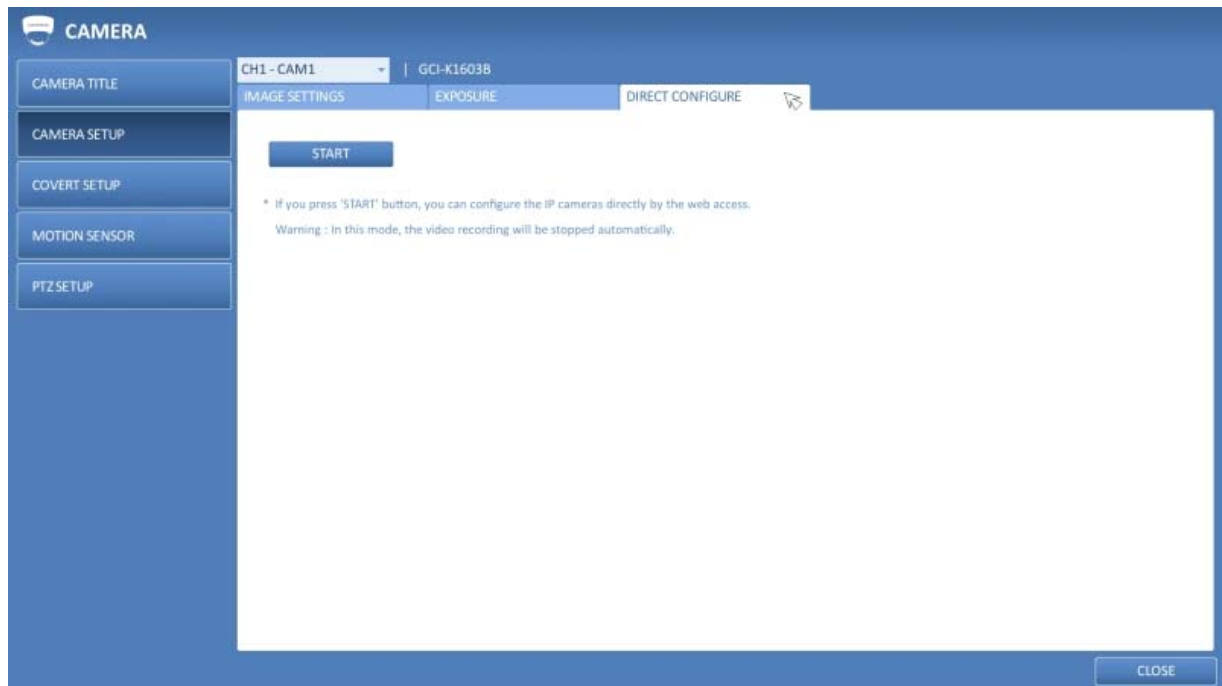

Click on the <START> button to activate the direct configure mode. To access the camera enter the IP address + the Webservice port of the NVR into your browser and enter the correct login data.

The IP address and the Webservice port you can find under SYSTEM > NETWORK > IP SETUP.

Click on the <STOP> button to leave the direct configure mode, after you have finished all settings.

NOTE: Functions of the camera that you cannot adjust with the NVR directly can be configured with the direct configure mode. Functions that can be changed with the NVR should not be changed with the direct configure mode, as the NVR will overwrite these after you have disabled the direct configure mode.

5. When done, press the [EXIT] button on the remote control or click on <CLOSE> in the lower screen. The confirmation message appears and you will return to the previous menu.

6.2.3. Covert Setup

You can set to hide the camera video so that a specific user or user group cannot view it. Set one or more channels that you want to hide from a specific user or user group.

1. From <SYSTEM SETUP> - <CAMERA>, select <COVERT SETUP>.

2. Use the [▲▼◀▶/ENTER] buttons on the remote control or use the mouse to select one or several covert channels from a specific user group.

> ADMIN, MANAGER, USER : If you set them to <ON>, the selected channels will be covert from the applicable user account.

> LOGOUT : Set it to <ON>. When the user logs out, the current channel will be set to a covert channel.

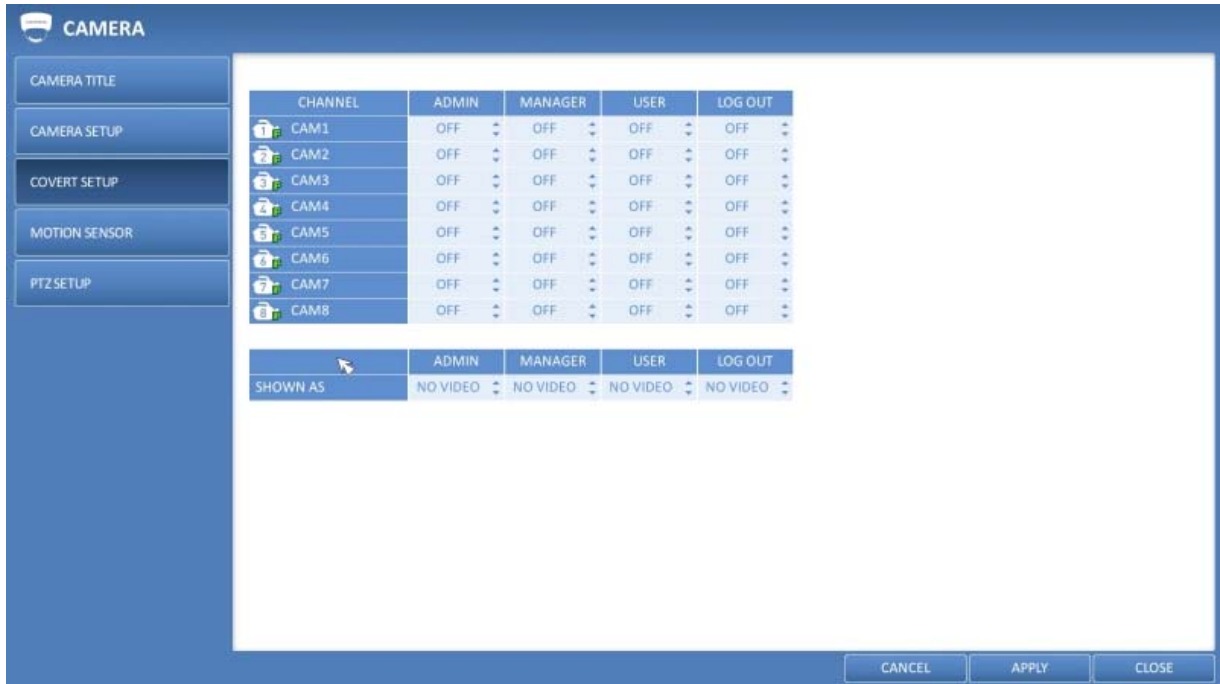

3. To apply the change, click on <APPLY> in the bottom of the screen.

4. When done, press the [EXIT] button on the remote control or click <CLOSE> in the lower screen. The confirmation message appears and you will return to the previous menu.

NOTE: To change the covert settings from 'user group' to 'user', move to the <USER> menu and make the necessary changes (Chapter 6.5.1. Management).

6.2.4. Motion Sensor

Set the motion sensor of the camera so that the NVR can detect a motion event.

1. From <SYSTEM SETUP> - <CAMERA>, select <MOTION SENSOR>.
2. Use the [▲▼◀▶/ENTER] buttons on the remote control or use the mouse to specify the use of each option item.
 - > ACTIVATION : Turn the motion sensor on or off.
 - > MOTION MARK : If you set it to <ON>, the video window will display the motion mark if a motion is detected.

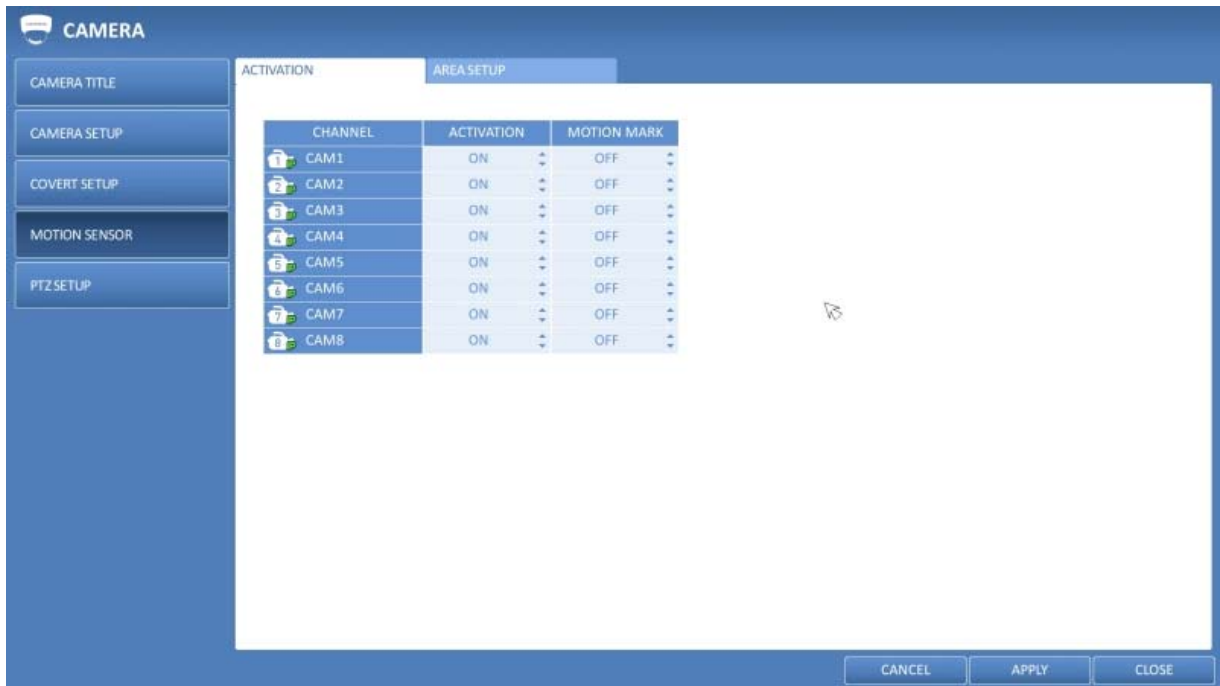

3. To apply the change, click on <APPLY> in the bottom of the screen.
4. When done, press the [EXIT] button on the remote control or click on <CLOSE> in the lower screen. The confirmation message appears and you will return to the previous menu.

NOTE: The above options such as <SENSITIVITY> and <MINIMUM BLOCKS> and how to set the motion area may be restricted depending on the specification of the connected camera.

Motion Area Setup :

In the motion setup window, click on <AREA SETUP> tab to display the motion area setup screen. Setting the motion area may differ depending on the camera model. Below is a typical setting of the motion area.

1. Click on <AREA SETUP> to move to the motion area setup screen.
2. If using the remote control, press the [ENTER] button to mark the current position.
3. Use the arrow buttons to move to a desired block and then press [ENTER]. The area setup will begin. Then, use the arrow buttons to specify the area. Alternatively, you can use the drag-and-drop method to specify or release the area by using the mouse.
4. If you select the specified area again, it will be released.

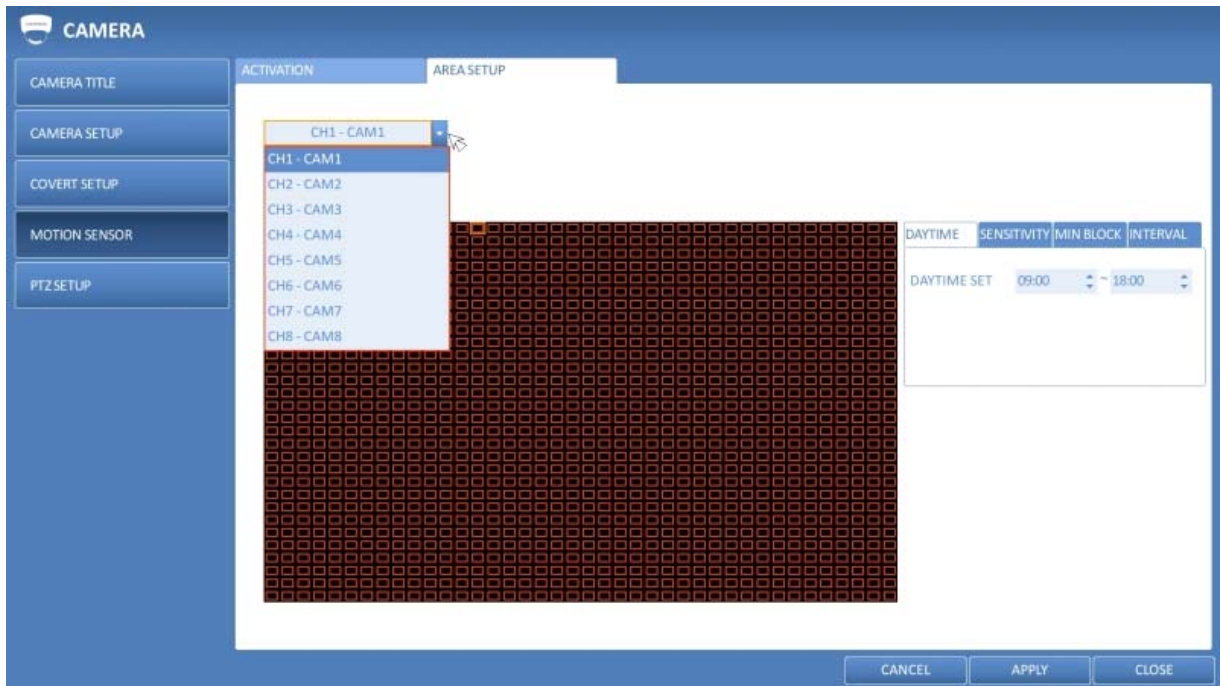

5. On the right side of the menu you can adjust the daytime and the sensitivity level of the motion detection with several options.

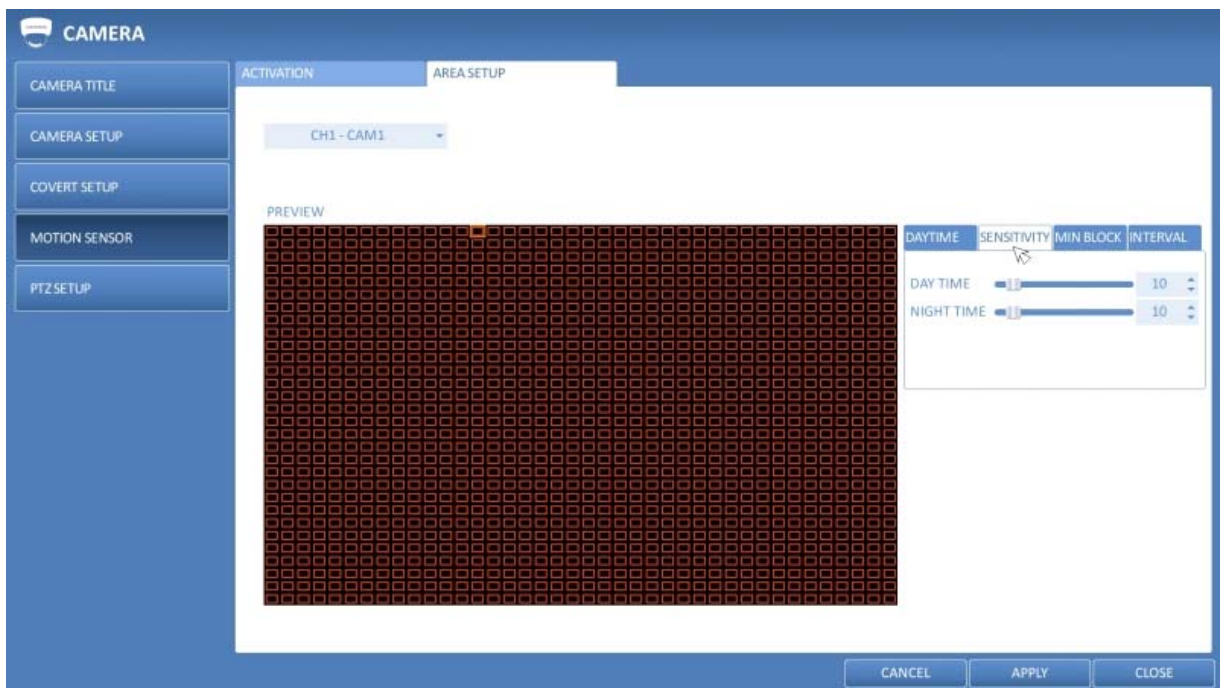

- DAYTIME : Specify the time period that will be considered as daytime.
- SENSITIVITY : Set the sensitivity level of the motion sensor to either Daytime or Nighttime: 1(Low) ~ 10(High) - The higher the number is, the higher the sensitivity level becomes.
- MINIMUM BLOCKS : Set the minimum number of blocks to Daytime or Nighttime if a motion is detected in several blocks in the motion sensor area: 1(High) ~ 10(Low) - The lower the number is, the higher the sensitivity level becomes.
- INTERVAL: Specify the time interval that will be used for motion detection. The lower the number the more often motion detection will be triggered.

NOTE: The images recorded in a low contrast scene such as at night can cause severe noise, triggering the motion event too often. If this is the case, please reduce the nighttime sensitivity to a degree.

6.2.5. PTZ Settings

You can set the camera ID, protocol, baud rate and data transmission speed for each channel.



1. From <SYSTEM SETUP> - <CAMERA>, select <PTZ SETUP>.
2. Use the [▲▼◀▶/ENTER] buttons of the remote control or mouse to set the address (ID), protocol and data transmission speed for each channel.
3. To apply the change, click on <APPLY> in the bottom of the screen. Once clicked on the <APPLY> button after changing the settings, a restarting message pops up. Click on <Yes> to restart the system automatically.
4. Once the setup is complete, press the [EXIT] button of the remote control or click on the <CLOSE> button on the bottom to display a confirmation dialog. Click on <CANCEL> to return to the previous menu.

6.3. Display Setting

You can configure the display settings regarding the OSD menus, monitor and sequence.

6.3.1. OSD

Configure the settings for the time, title, border, icon and language that will be displayed on the screen.

1. From <SYSTEM SETUP> - <DISPLAY>, select <OSD>.
2. Use the [▲▼◀▶/ENTER] buttons on the remote control or use the mouse to set each option of the OSD item.



- > CAMERA TITLE : Specify the display of the camera title on the screen.
- > RECORDING MODE ICON : Specify the display of the record mode icon on the screen.
- > AUDIO ICON : Specify the display of the audio icon on the screen.
- > STATUS BAR IN FULL SCREEN MODE : Select to show/ how to show or hide the status bar in full screen mode.
 - AUTO HIDE : Place the cursor in the lower area of the screen to display the status bar. If moving the cursor up, the status bar will disappear.
 - ALWAYS ON : The status bar will be displayed at all times.
 - 5 SEC ~1 MIN : If no mouse movement is detected for: from 5 seconds to 1 minute, the status bar will disappear.
- > TIMELINE IN FULL SCREEN MODE : Select to show or hide the timeline in full screen mode.
 - AUTO HIDE : Place the cursor in the right corner to display the timeline. If moving the cursor to the left, the timeline will disappear.
 - ALWAYS ON : The timeline will be displayed at all times.
 - ALWAYS OFF : The timeline will not be displayed.
- > BORDER LINE : Specify the display of the cross border between channels in a split mode.
- > BORDER COLOR : Select a color for the border.
- > USER NAME : Specify the display of the currently logged-in users on the status bar.
- > LANGUAGE : Select a menu display language.

3. To apply the change, click on <APPLY> in the bottom of the screen.
4. When done, press the [EXIT] button on the remote control or click on <CLOSE> in the lower screen. The confirmation message will appear and you will return to the previous menu.

6.3.2. Monitor

If you change from monitoring mode to sequence, you will have to set the interval of the sequence first.

1. From <SYSTEM SETUP> - <DISPLAY>, select <MONITOR>.
2. Use the [▲▼◀▶/ENTER] buttons on the remote control or use the mouse to set a sequence interval for auto mode, from 1 to 60 seconds.
3. To apply the change, click on <APPLY> in the bottom of the screen.
4. When done, press the [EXIT] button on the remote control or click <CLOSE> in the lower screen. The confirmation message will appear and you will return to the previous menu.

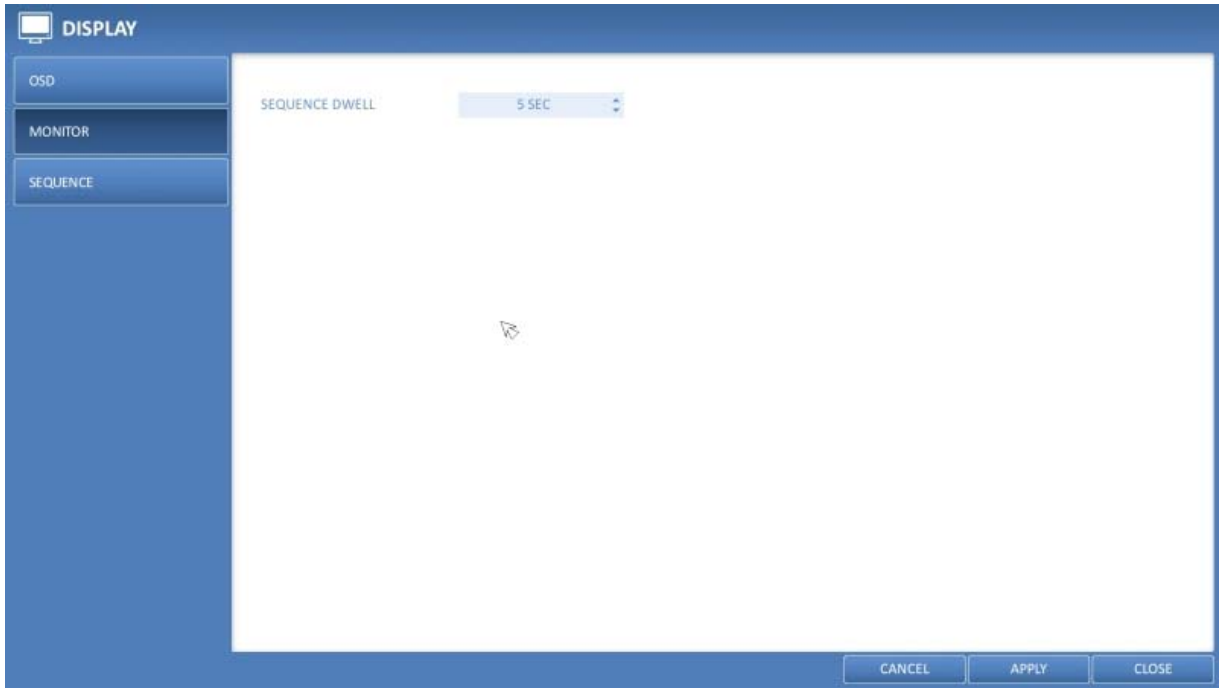

6.3.3. Sequence

Select a split mode for the sequence, and also select a list of active items when the sequence is performed.

1. From <SYSTEM SETUP> - <DISPLAY>, select <SEQUENCE>.
 2. Use the [▲▼◀▶/ENTER] buttons on the remote control or use the mouse to add a sequence or change the settings of the existing sequence.
- > ACTIVATION : Select a list that you want to activate the sequence for. Only one list will become active.
 - > ADD : Add a sequence.

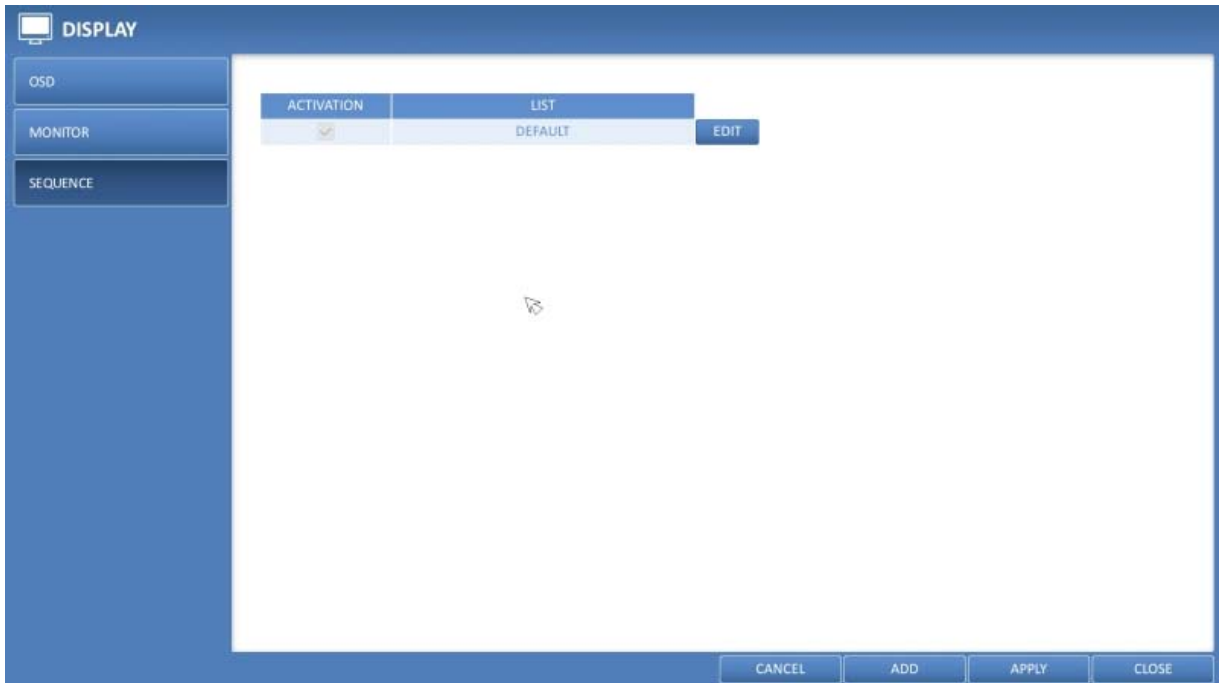

3. To apply the change, click on <APPLY> in the bottom of the screen.
4. When done, press the [EXIT] button on the remote control or click on <CLOSE> in the lower screen. The confirmation message will appear and you will return to the previous menu.

How to add a sequence :

1. Click on <ADD> in the bottom of the screen.
2. When the "ADD" dialogue appears, enter a title using the virtual keyboard.
3. Enter the name of the sequence and click on <ADD>.
4. When the <ADD VIEW TYPE> dialogue appears, click on <ADD>.
5. When the "SEQUENCE SETUP" dialogue appears, select a split mode that you want to add from <VIEW TYPE>.

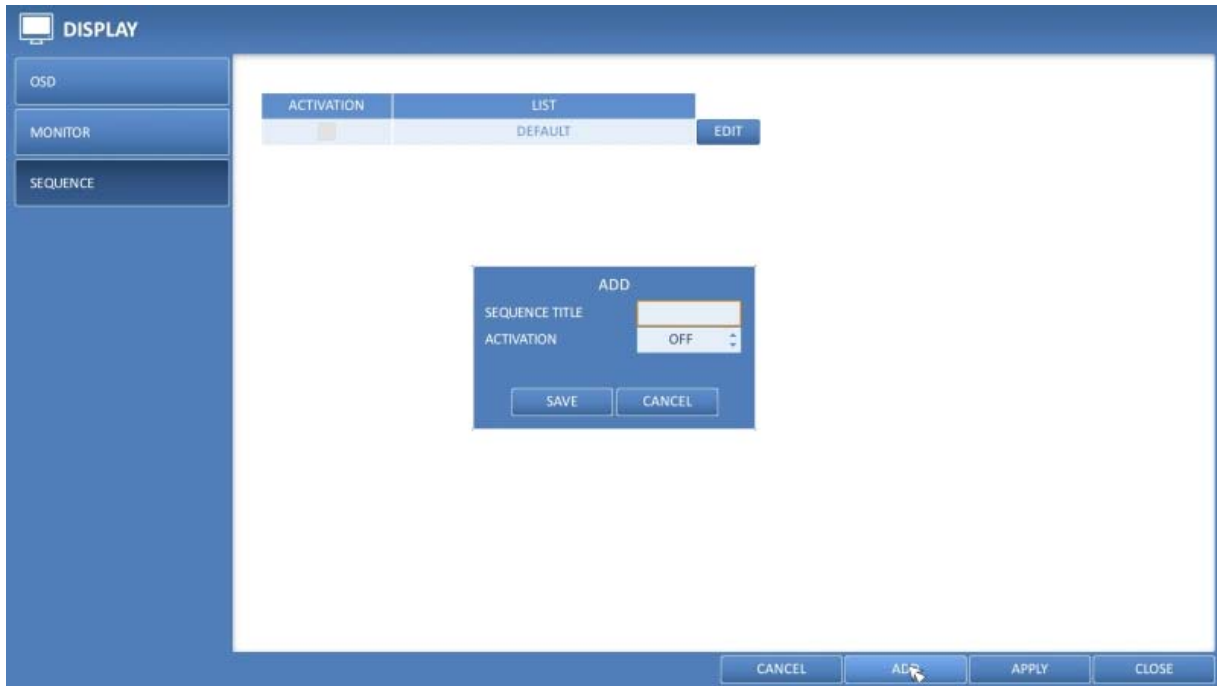

6. If the selected split mode is displayed on <CONFIGURATION VIEW>, select a channel you want to display in each split screen.
7. If you click <OK>, the set sequence mode will be confirmed and it will be added to the Sequence list in order.
8. When done, click on <CLOSE> in the bottom of the screen. After the sequence type is saved, you will return to the previous screen.

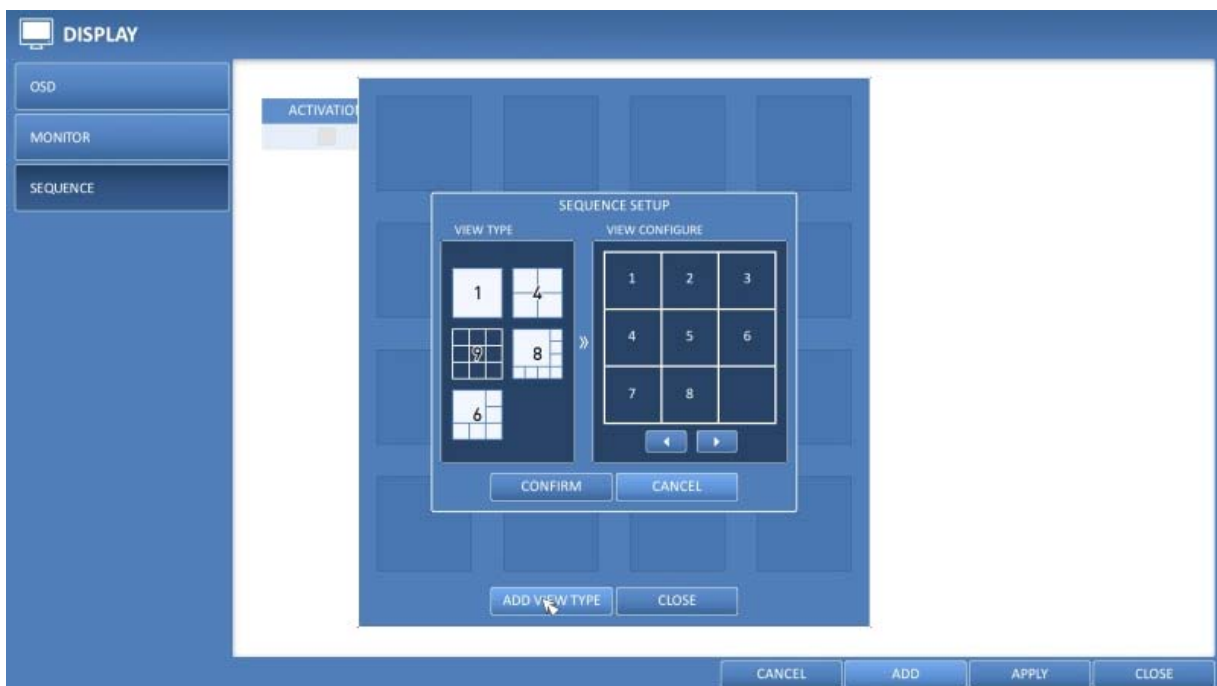

9. Right-click on the new sequence, or press the [ENTER] button on the remote control to edit or delete it.

How to edit a sequence :

1. Select a sequence that you want to edit from the list.
2. The "EDIT" dialogue appears.
3. Use the [▲▼◀▶/ENTER] buttons on the remote control or use the mouse to edit the selected sequence.



- > SEQUENCE TITLE : Enter a new sequence name.
- > ACTIVATION : Specify the use of the sequence.
- > MODIFY : Change the settings of the sequence mode.
- > DELETE : Delete the selected sequence list.
- > CANCEL : Cancel the changes.

4. Pressing the <EDIT> button will display the Edit Sequence window.
5. To change the existing settings, select a screen mode that you want to edit and right-click to display the context menu. Then, select <EDIT>.
6. When done, click <CLOSE> to close the window.
7. To apply your changes, click on <APPLY>.

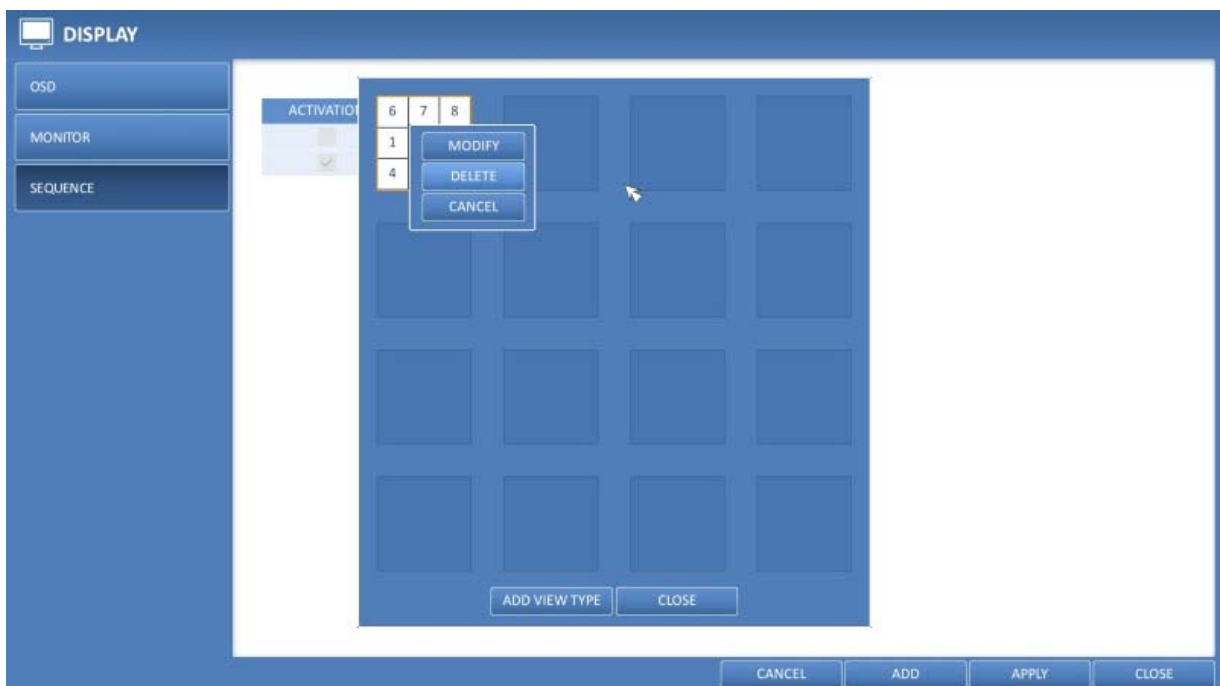

6.4. Audio Setup

You can configure the audio and the signal beeps.

6.4.1. Audio

You can configure here the default audio channel and configure the network audio transmission.

1. From <SYSTEM SETUP> - <AUDIO>, select <AUDIO>.
2. Use the [**▲▼◀▶**]/ENTER] buttons on the remote control or use the mouse to select an item that you want to edit.
 - > DEFAULT LIVE AUDIO CHANNEL : Select an audio channel to monitor on the live screen.
 - > NETWORK AUDIO TRANSMISSION : Decide if the NVR transfers the audio signal to the remote client.
 - > RECEIVE NETWORK AUDIO : Decide if the NVR receives the audio signal from the remote client.

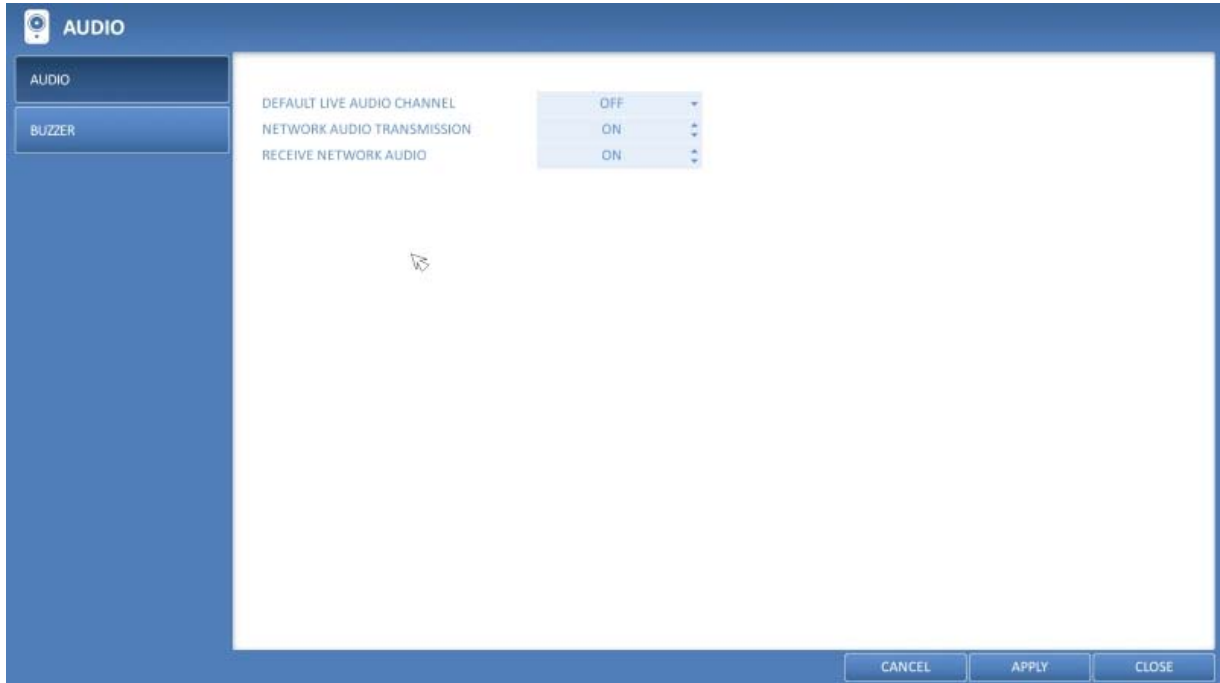

3. To apply the change, click on <APPLY> in the bottom of the screen.
4. When done, press the [EXIT] button on the remote control or click <CLOSE> in the lower screen. The confirmation message appears and you will return to the previous menu.

6.4.2. Buzzer Output

You can set to output the buzzer if you use the remote control.

1. From <SYSTEM SETUP> - <AUDIO>, select <BUZZER>.
2. Use the [▲▼◀▶/ENTER] buttons on the remote control or use the mouse to select an item that you want to edit.
> REMOTE CONTROLLER : specify the output of a beep when you press a button on the remote control.
3. To apply the change, click on <APPLY> in the bottom of the screen.

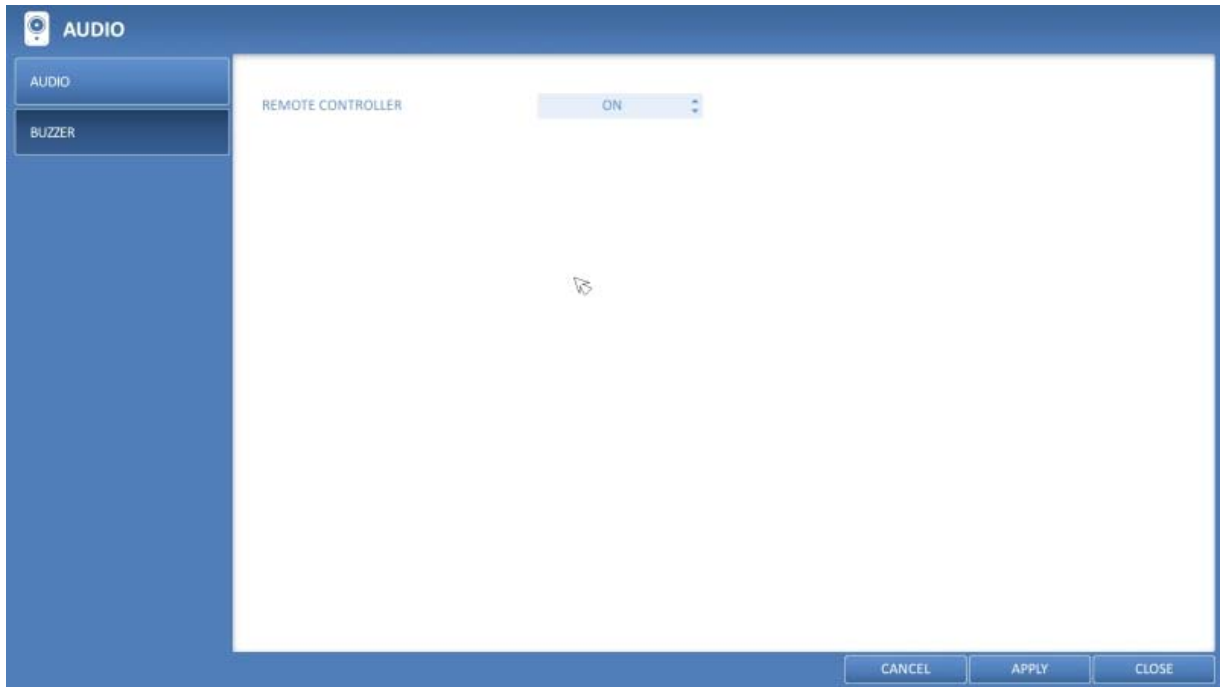

4. When done, press the [EXIT] button on the remote control or click on <CLOSE> in the lower screen. The confirmation message will appear and you will return to the previous menu.

6.5. User Setting

You can configure the settings regarding the user management and regarding the user and group permissions.

6.5.1. Management

You can add one or more user account(s) that can be edited at a later time.

1. From <SYSTEM SETUP> - <USER>, select <MANAGEMENT>.
2. Use the [▲▼◀▶/ENTER] buttons on the remote control or use the mouse to add a user account or select an item that you want to edit.
3. To apply the change, click on <APPLY> in the bottom of the screen.
4. When done, press the [EXIT] button on the remote control or click on <CLOSE> in the lower screen. The confirmation message will appear and you will return to the previous menu.

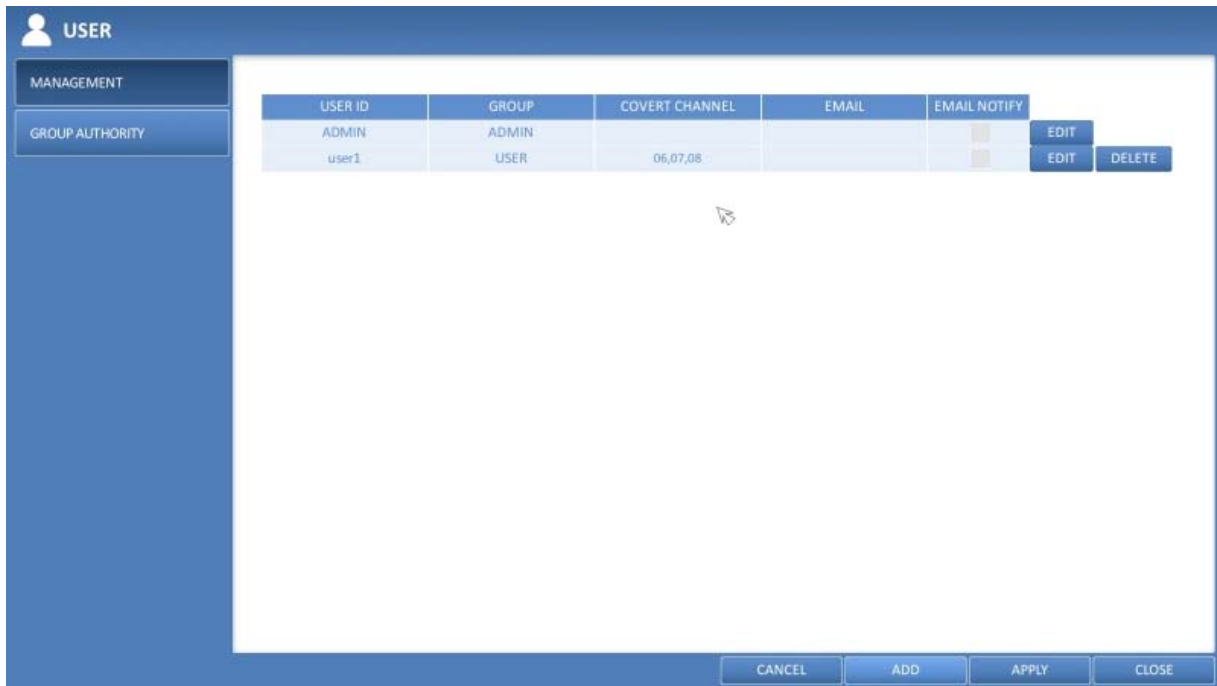

How to add a user account :

1. Click <ADD> in the bottom of the screen.
2. Use the [▲▼◀▶] buttons on the remote control and move to a desired item. Then, press [ENTER] to select the item.

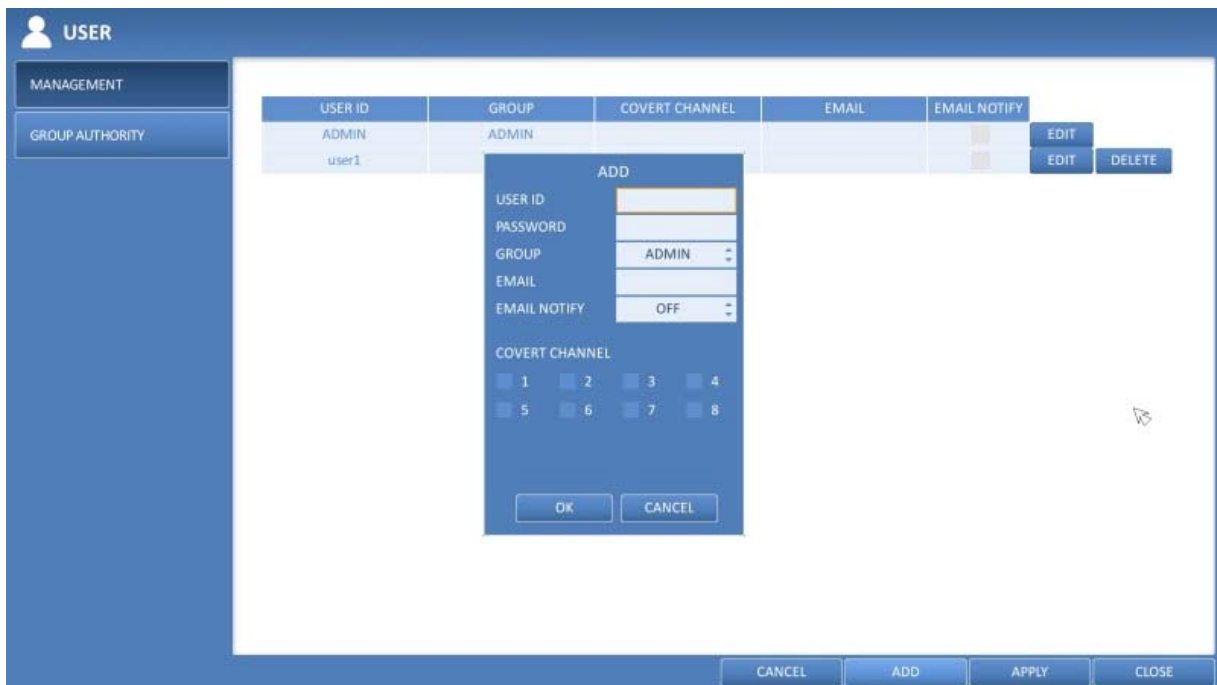

- > USER ID : Enter the user ID using the virtual keyboard.
- > PASSWORD : With the virtual keyboard, enter the password.
- > GROUP : Select a group that the user belongs to, from <ADMIN>, <MANAGER> and <USER>.
- > EMAIL : Type in the e-mail address to which you will receive a notification of an event if it occurs.
- > EMAIL NOTIFY : Choose whether you will receive a notification of an event if it occurs.
- > COVERT CHANNEL : You can set the channel to hide from a specific user.

3. When done, click on <OK>. The added user account will be listed.

How to edit the user account information :

1. From the list of users, select a user account to edit and click <EDIT> next to it.
2. In the Edit window, make the necessary changes and click on <OK>.
3. To delete the user account, click on <DELETE>.

NOTE: The <ADMIN> account cannot be changed or edited.

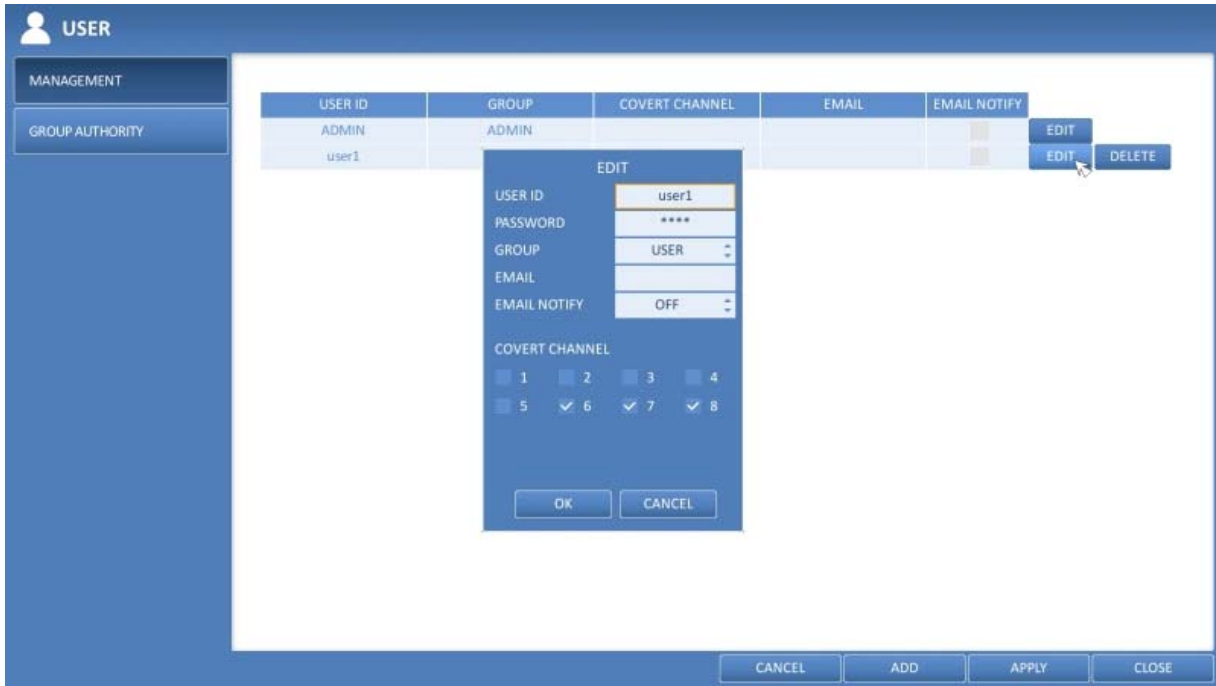

6.5.2. Group Authority

You can grant different user groups different permissions to a specific menu.

1. From <SYSTEM SETUP> - <USER>, select <GROUP AUTHORITY>.
2. Use the [▲▼◀▶/ENTER] buttons or use the mouse to set the permissions for both <MANAGER> and <USER> groups.



- > SEARCH : Set the permissions for the Search menu.
- > ARCHIVING : Set the permissions for the Backup menu.
- > SYSTEM SETUP : Set the permissions for the System Setup menu.
- > RECORD SETUP : Set the Access Permissions for the Record Setup menu.
- > EVENT ACTION CONTROL : Set the permissions to output the alarm or control the buzzer if an event such as an alarm occurs.
- > LISTEN TO AUDIO : Set the permission to listen to the audio.
- > MICROPHONE : Set the permission to speak through the microphone.
- > REMOTE LOG IN : Set the permission to access the System menu remotely.
- > SHUTDOWN : Set the permission to shut down the NVR from the System menu.

3. To apply the change, click on <APPLY> in the bottom of the screen.

4. When done, press the [EXIT] button on the remote control or click on <CLOSE> in the lower screen. The confirmation message will appear and you will return to the previous menu.

6.6. Network Setting

Specify the IP address, the DDNS and Email address.

6.6.1. IP Setup

Specify the IP address as well as the remote service port.

1. From <SYSTEM SETUP> - <NETWORK>, select <IP SETUP>.

2. Use the [▲▼◀▶/ENTER] buttons on the remote control or use the mouse to specify each item of the network settings.

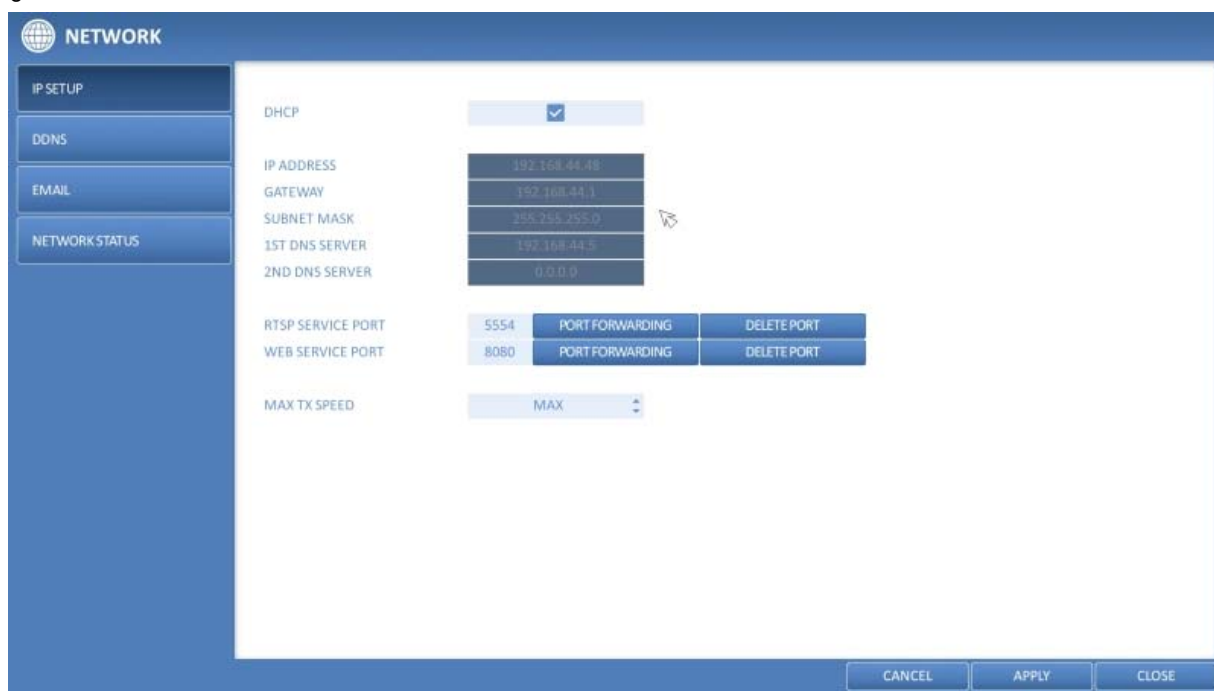

> DHCP : If it is checked, set the IP address of the NVR to Dynamic IP.

- If the <DHCP> item is checked, the sub items of IP address, gateway, subnet mask, primary DNS server, secondary DNS server will be filled in automatically.

ATTENTION: If you select to obtain an IP address from the <DHCP> server, when the lease time of the DHCP server expires, you will lose connection to the IP camera momentarily while the network settings will be updated.

- > IP ADDRESS : Provide the IP address.
- > GATEWAY : Provide the gateway address.
- > SUBNET MASK : Provide the subnet mask address.
- > 1ST DNS SERVER : Enter the address of the primary DNS server.
- > 2ND DNS SERVER : Enter the address of the secondary DNS server.
- > RTSP SERVICE PORT : Port number that the remote client receives the NVR video from.
- > WEB SERVER PORT : Port number used for connecting to the NVR with the web browser.
- > PORT FORWARDING : If you are using a router, you can set the port forwarding so that the external access to the NVR is enabled. If the router does not support the UPnP protocol, you must set the port forwarding manually. For more information, contact your network administrator.
- > DELETE PORT : Release the port forwarding settings for the router.
- > MAX TX SPEED : Limit the network transfer rate to access a remote client. The video signal may be transferred at a lesser rate than specified, which depends on the status of your network connection.

3. To apply the change, click on <APPLY> in the bottom of the screen.
4. When done, press the [EXIT] button on the remote control or click <CLOSE> in the lower screen. The confirmation message will appear and you will return to the previous menu.

6.6.2. DDNS

You can configure the DDNS settings so that remote users who are connected to the network can access the system remotely.

NOTE: DDNS is an IP redirection service in a dynamic IP environment that redirects (maps) the new IP address to a registered domain name each time the IP address is changed.

1. From <SYSTEM SETUP> - <NETWORK>, select <DDNS>.
2. Use the [▲▼◀▶/ENTER] buttons on the remote control or use the mouse to specify the use of DDNS and select a server.

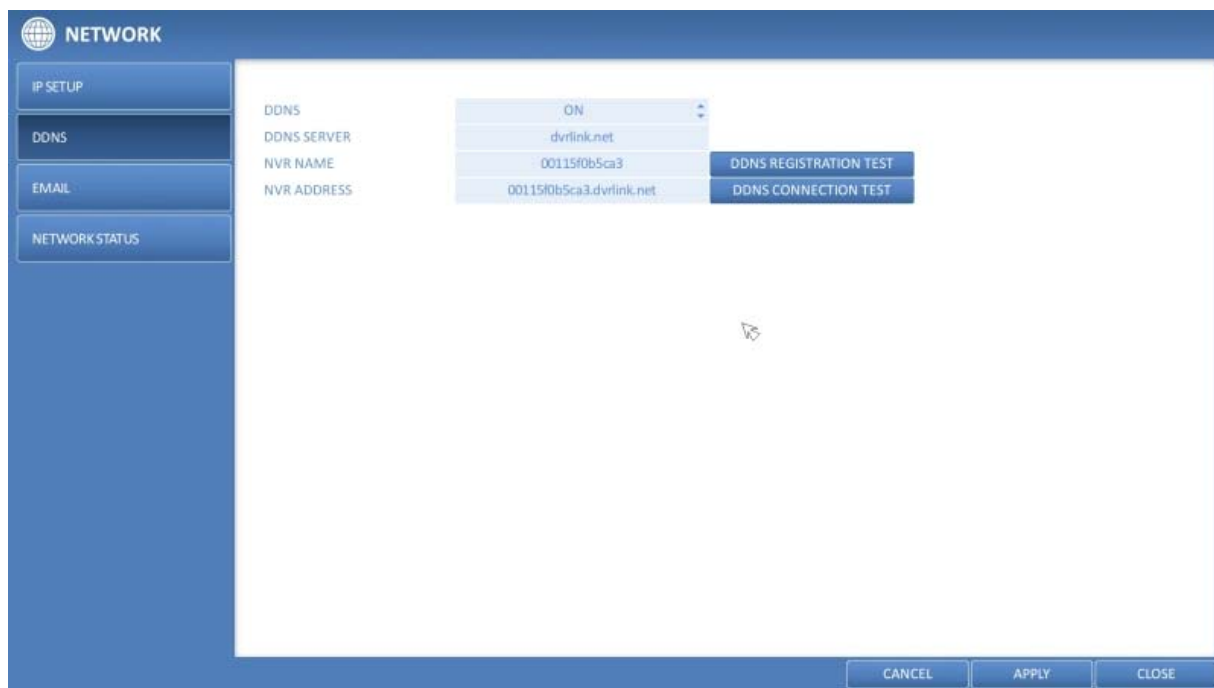

- > DDNS : Specify the use of DDNS connection.
- > DDNS SERVER : Select a server to connect to.
- > NVR NAME : Enter the name of the NVR that you want to use as DDNS.
- > DDNS REGISTRATION TEST : Check if the <NVR NAME> can be set as DDNS. If there is a duplicate name in the server, the registration will fail. If this is the case, rename the <NVR NAME> and press <DDNS REGISTRATION TEST> to check if it works properly.
- > NVR ADDRESS : Provide the <NVR NAME> and press the <DDNS REGISTRATION TEST> button. The name will be added automatically.
- > DDNS CONNECTION TEST : Perform the connection test to check if DDNS is normally registered.

3. To apply the change, click on <APPLY> in the bottom of the screen.
4. When done, press the [EXIT] button on the remote control or click <CLOSE> in the lower screen. The confirmation message will appear and you will return to the previous menu.

6.6.3. Email

You can register and test an email address so that an email notification can be delivered at a specific interval or if an event occurs.

1. From <SYSTEM SETUP> - <NETWORK>, select <EMAIL>.
2. Use the [▲▼◀▶/ENTER] buttons on the remote control or use the mouse to specify the use of email and select a server.

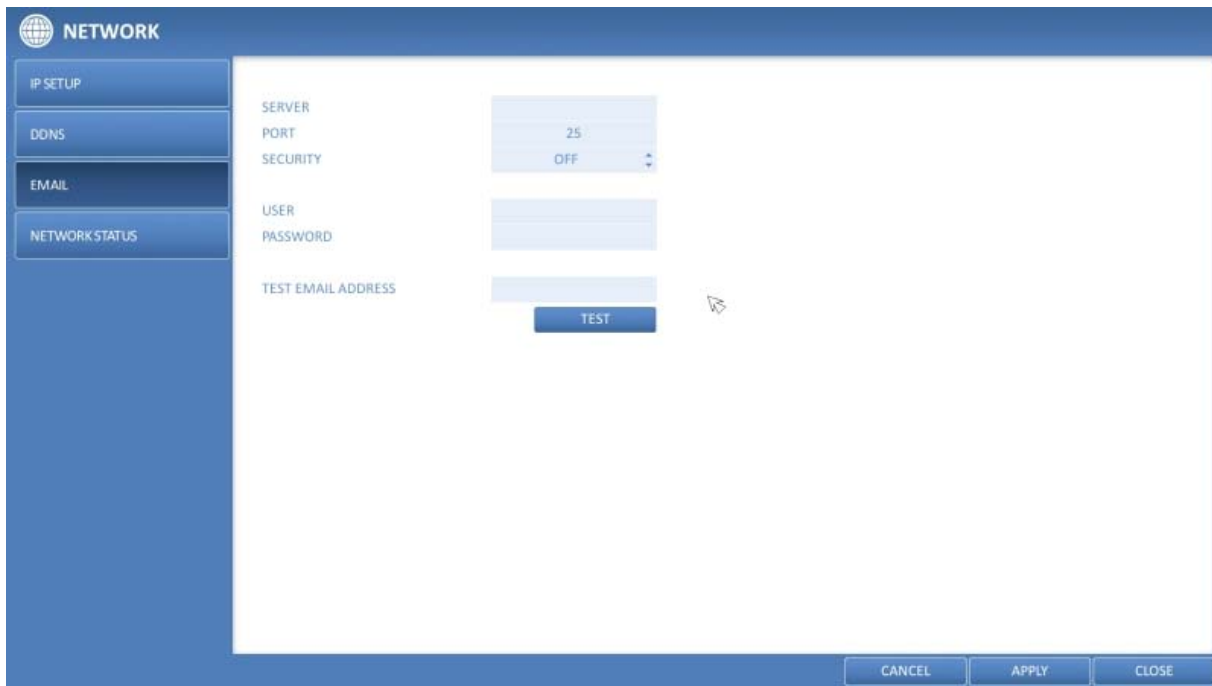

- > SERVER : Set up the mail server. Set the mail server that will be used for notification to the NVR. Use the virtual keyboard to enter your mail server.
- > PORT : Enter the mail server port.
- > SECURITY : If it is set to <ON>, the email will be transferred in secure mode. If it is set to <OFF>, the email will be transferred to a server that does not support SSL.
- > USER : Provide the email account (ID) of the sender.
- > PASSWORD : Provide the password of the sender.
- > TEST EMAIL ADDRESS : Enter an email address for the test purpose.
- > TEST : Send a test email and check if the test email is delivered normally.

3. To apply the change, click on <APPLY> in the bottom of the screen.
4. When done, press the [EXIT] button on the remote control or click <CLOSE> in the lower screen. The confirmation message will appear and you will return to the previous menu.

6.6.4. Network Status

From the network map screen, you can check the internet connection status and IP camera connection status, and check also the details of the connection status for each camera.

1. From <SYSTEM SETUP> - <NETWORK>, select <NETWORK STATUS>.
2. Use the [▲▼◀▶/ENTER] buttons on the remote control or use the mouse to select one from <NETWORK MAP> and <DETAIL STATUS>.
3. When done, press the [EXIT] button on the remote control or click on <CLOSE> in the lower screen. The confirmation message will appear and you will return to the previous menu.

Network Map :

- > IP ADDRESS : Indicates the internal IP address of the NVR.
- > MAC ADDRESS : Indicates the internal MAC address of the NVR.
- > DDNS ADDRESS : Indicates the internal DDNS address of the NVR.
- > RTSP SERVICE PORT : Indicates the network port of the video service. For remote service, the router must have set up the port forwarding.
- > WEB SERVICE PORT : Indicates the web service network port. For the remote service to be enabled, the corresponding port of the router should have set up the port forwarding.
- > DDNS UPDATE STATUS : Shows if the DDNS address was registered to the DDNS server normally. Press the 'Blue Arrow in a Circle' Button next to the status to try to register the DDNS address forcibly.
- > EXTERNAL IP ADDRESS : Indicate the IP address for the Internet, accessible from the NVR. The NVR can be granted access with the web browser at "http://<External IP Address>:<Web Service Port>". The IP address can vary in a dynamic IP environment.
- > CONNECTED CLIENTS : Shows the list of clients that are currently connected. Press the according 'Connect/Disconnect' Button next to the chosen Client to terminate the connection of an unwanted client forcibly.

NOTE: Termination is limited to users in a lower group than the current user.

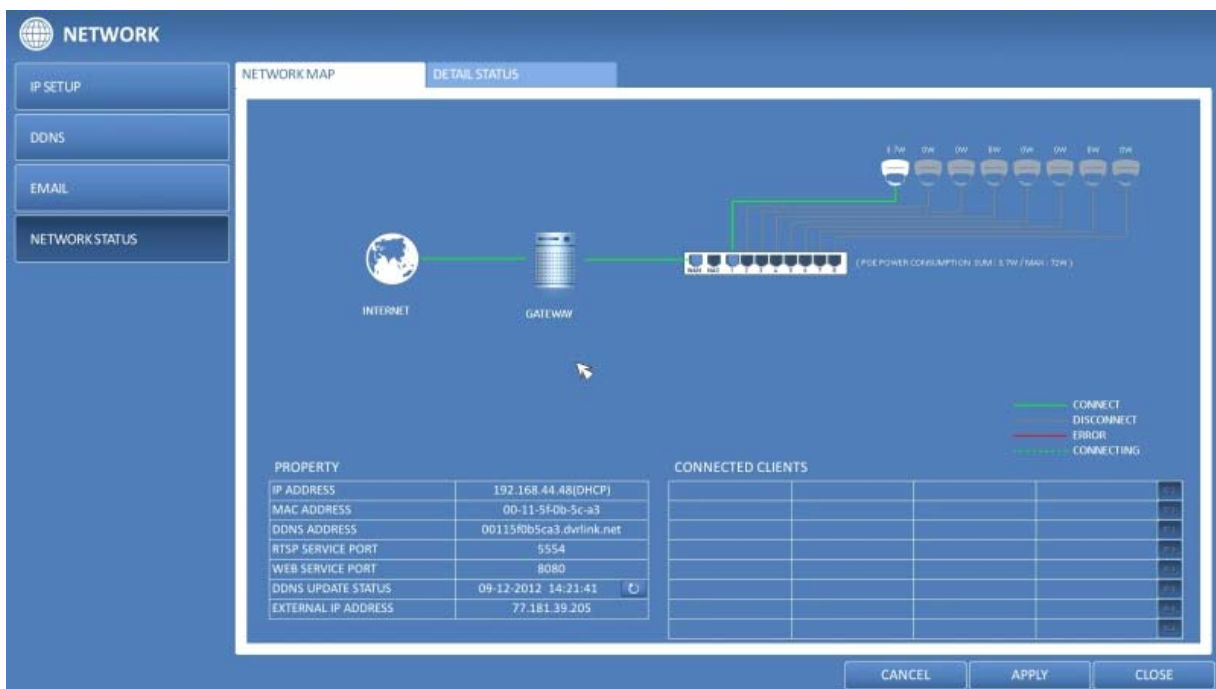

NOTE: The current PoE power consumption is updated sequentially in the order of channels.

NOTE: An Alarm is generated if the power consumption reaches 90% of the rated supply capacity, for both the NVR main unit and the external PoE Hub. This alarm threshold setting can be edited in "EVENT > SYSTEM EVENT > POE FAIL EVENT".

Detail Status :

You can check the details of the cameras that are connected to each channel. Click on the 'Cogwheel' Button in the right area of the list to show the details. Click <RESET> in the "IP CAMERA CONFIGURATION" window to reset the IP camera. When the IP camera settings are complete, click on <OK>.

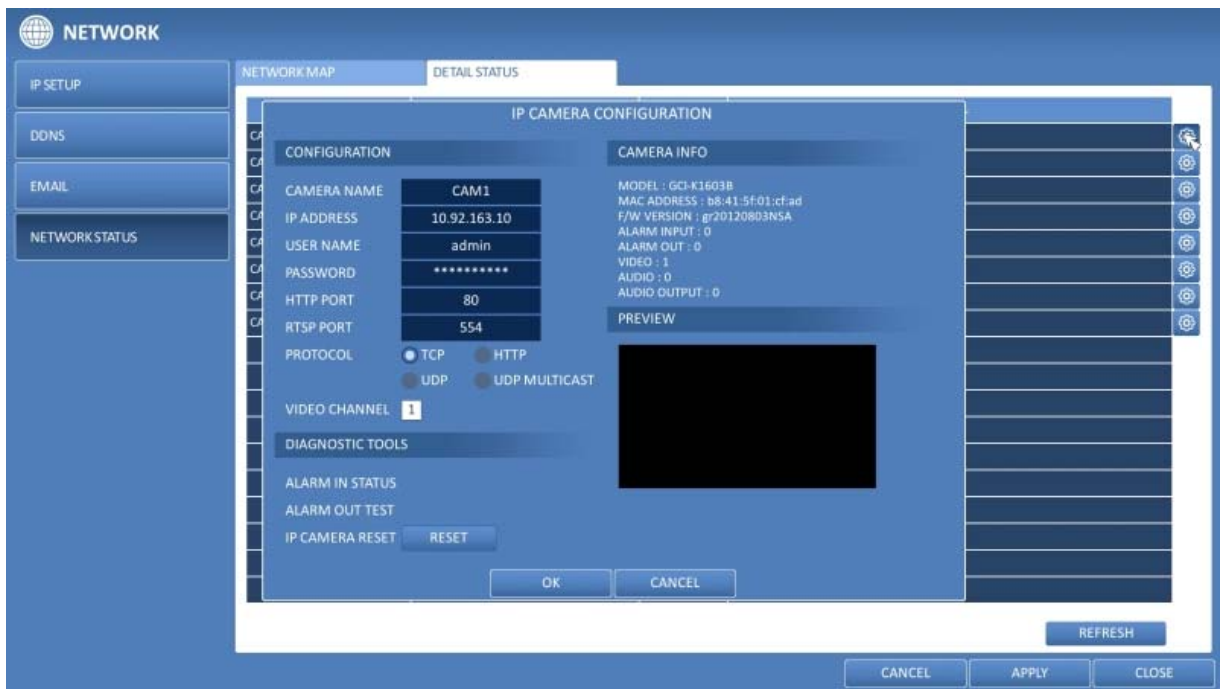

6.7. System Setup

You can configure the settings of date/time, system management, and keyboard controller.

6.7.1. Date/Time

Specify the current date and time.

1. From <SYSTEM SETUP> - <SYSTEM>, select <DATE/TIME>.
2. Use the [▲▼◀▶/ENTER] buttons on the remote control or use the mouse to change the time or set the options as necessary.



- > DATE/TIME : Set the current time and date. Click on the 'Clock' Button to adjust the time manually.
- > DATE FORMAT : Specify the date format.
- > TIME FORMAT : Specify the time format.
- > TIME SERVER : Obtain the current time from the time server. Click on the 'Arrows in a Circle' Button to get the current time.
- > AUTO TIME SYNC : Automatically synchronise the time with the time server at a specific time.
- > SYNC AT : Set the time to synchronise with the time server.
- > TIMEZONE : Specify the GMT standard time for your local area.
- > DST : You can set up or release the DST (Daylight Saving Time).

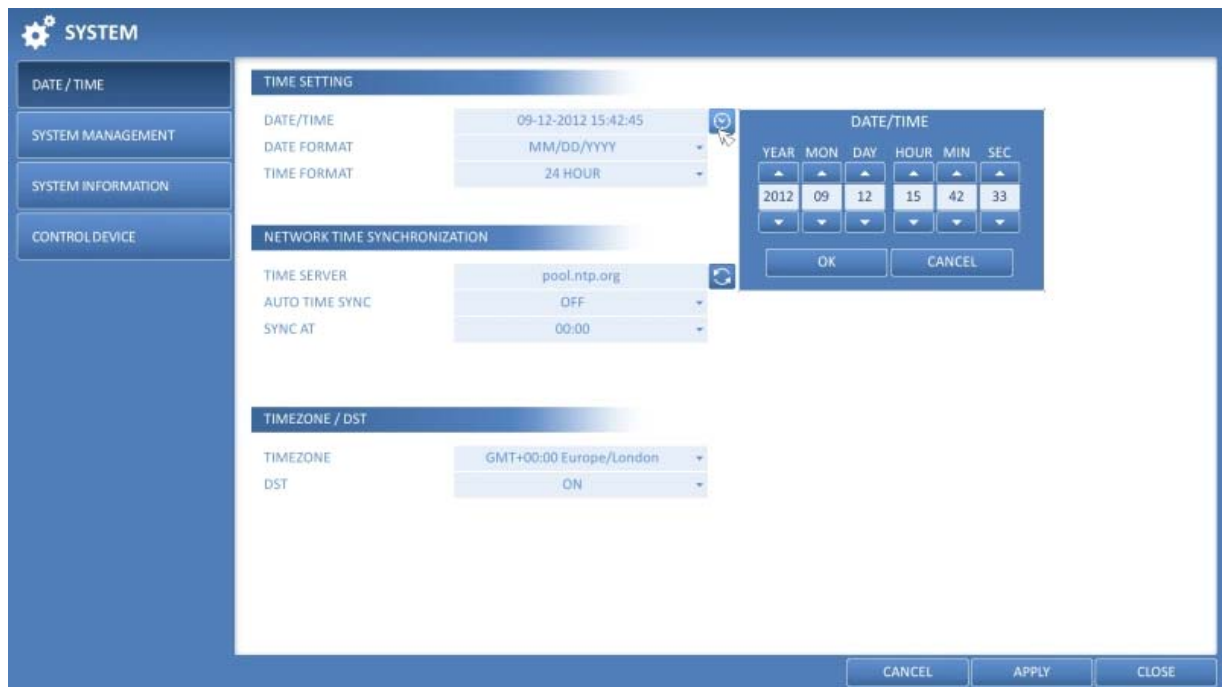

3. To apply the change, click on <APPLY> in the bottom of the screen.
4. When done, press the [EXIT] button on the remote control or click on <CLOSE> in the lower screen. The confirmation message will appear and you will return to the previous menu.

6.7.2. System Management

You can check, update or reset the system information.

1. From <SYSTEM SETUP> - <SYSTEM>, select <SYSTEM MANAGEMENT>.
2. Use the [▲▼◀▶/ENTER] buttons on the remote control or use the mouse to set each option of the system management.



- > FW UPDATE : You can update the current software with the latest version.
- > FACTORY DEFAULT : Set the NVR settings to factory default.
- > SYSTEM DATA : Save the system settings or get the system information from another device.
 - SAVE : Store the NVR settings to a storage device. Connect the storage device to the USB port of the NVR.

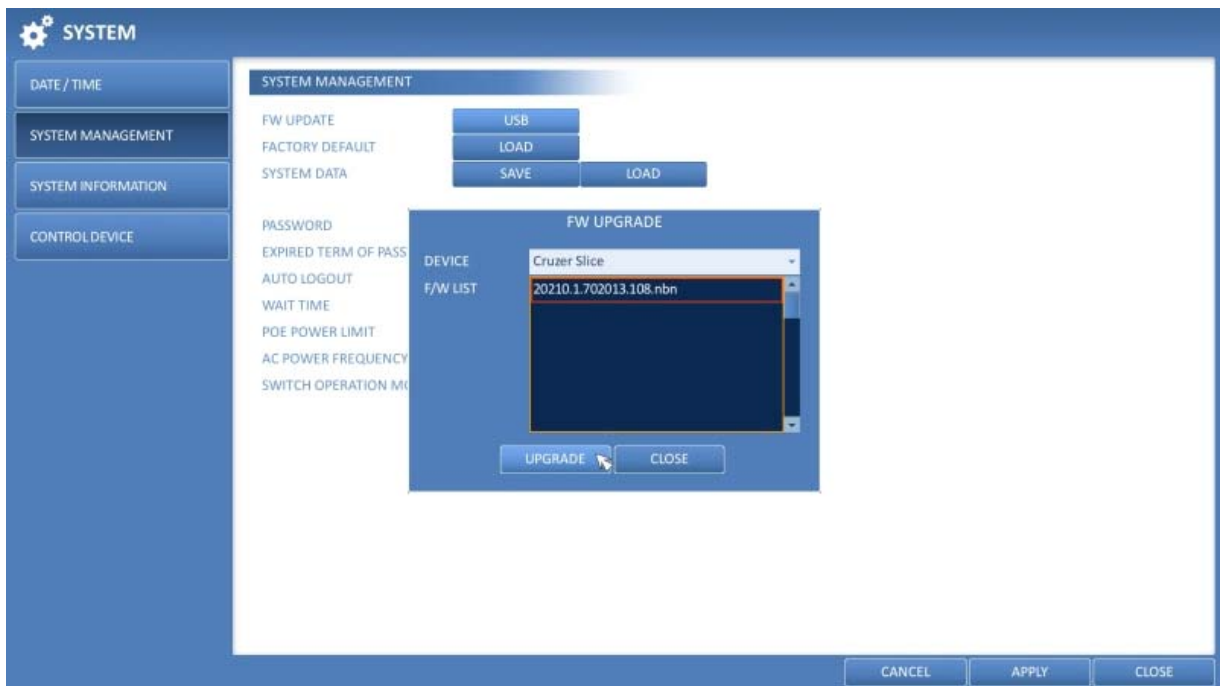

- LOAD : Apply the settings of the storage device to the NVR. Connect the storage device to the USB port of the NVR.

> PASSWORD : Open or close the dialogue box for the settings of the menus: quit, system settings, record settings, backup, and search.

NOTE: If it is set to <OFF>, note that only the ADMIN account will be working and access to all menus will be restricted.

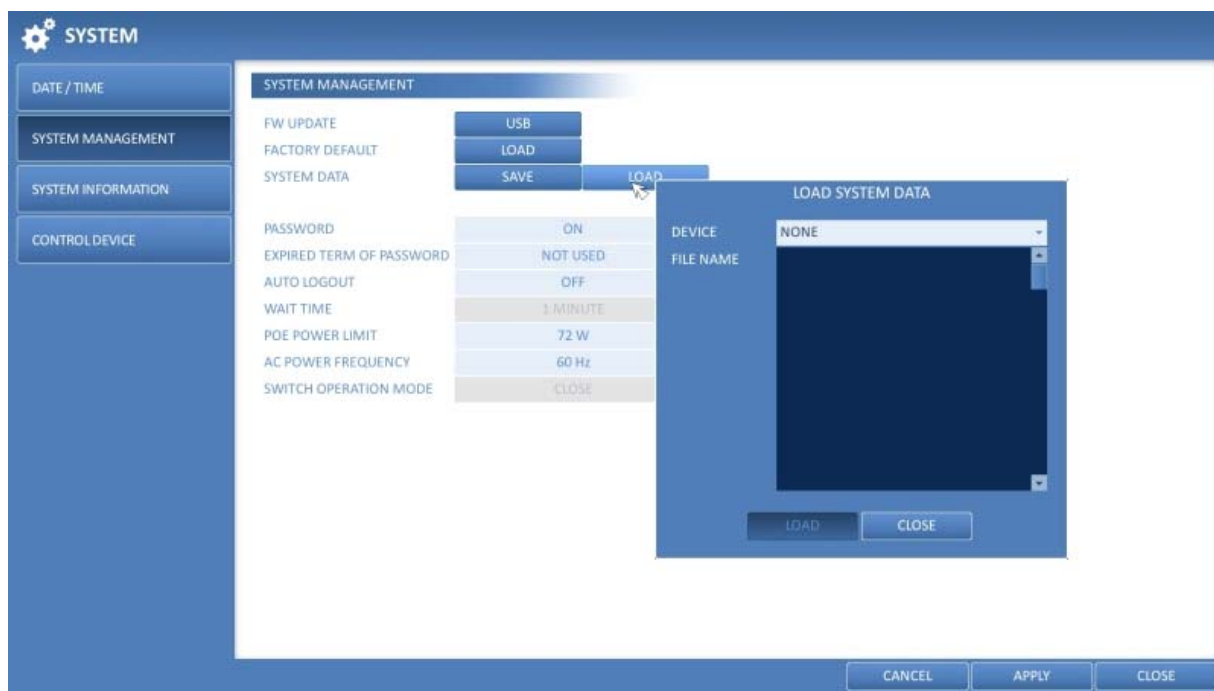

> EXPIRED TERM FOR PASSWORD : You will be prompted to change the current password after a certain period of time.

> AUTO LOGOUT : If there is no user input for a certain period of time, you can set to log out automatically.

> WAITING TIME : Specify the waiting time for the Auto Logout.

> POE POWER LIMIT (HUB)* : Sets the nominal power consumption of the External PoE Hub's power adapter.

> AC POWER FREQUENCY* : Set to the actual AC power's frequency (50Hz / 60Hz) applied to the NVR to avoid flickering.

*These functions are applicable for the 16Ch NVR model GRI-K4416A.

3. When done, press the [EXIT] button on the remote control or click on <CLOSE> in the lower screen to return to the previous menu.

How to perform the upgrade :

1. Connect the USB storage device that contains the updatable files.
2. Click on <USB>.
3. Select one or several ones from the updatable files listed in <F/W LIST>.

NOTE: The Firmware should be located in the <root> directory of the USB storage device. Do not place it under a certain folder.

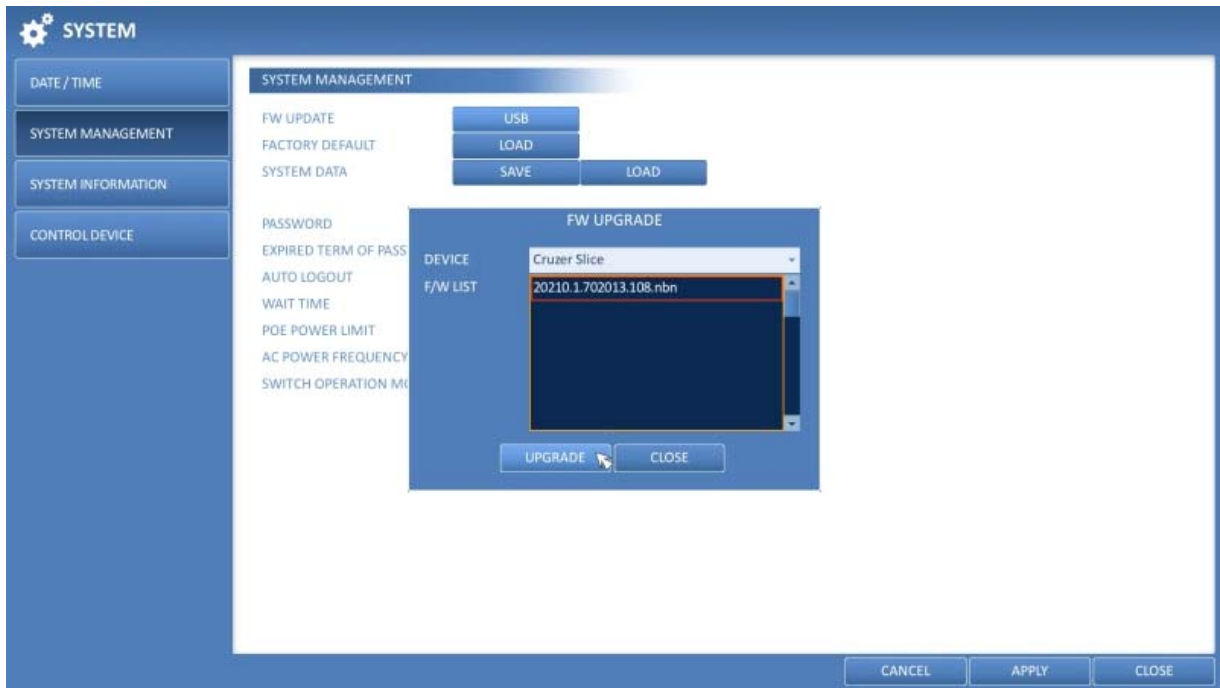

4. Click on <UPGRADE>.
5. When the confirmation message appears, click on <OK>.



6. The progress bar displays the progress of the firmware upgrade process.
7. When the upgrade is complete, reboot the system.

ATTENTION: During the updating, never turn off the NVR forcibly or disconnect the USB storage device to avoid serious damage to the product or data. If required, consult your nearest service center for professional assistance.

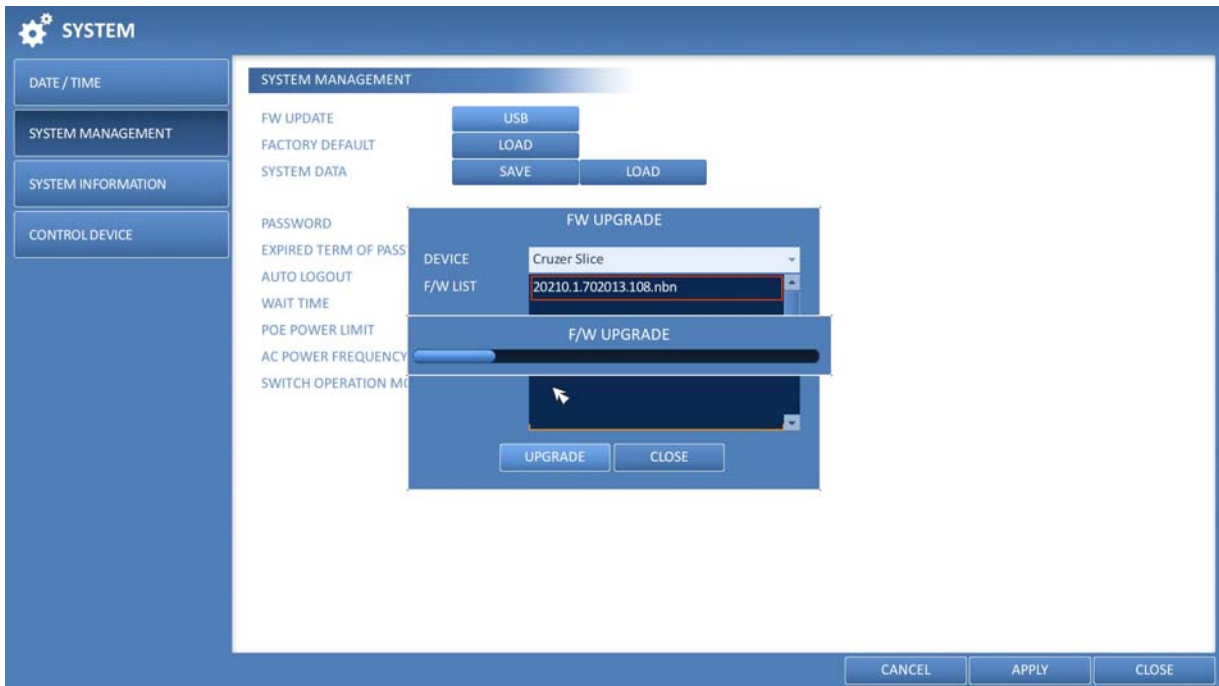

6.7.3. System Information

You can check the current system version and system-related settings.

1. From <SYSTEM SETUP> - <SYSTEM>, select <SYSTEM INFORMATION>.
2. Check the status of the current system.
3. When done, press the [EXIT] button on the remote control or click on <CLOSE> in the lower screen. The confirmation message will appear and you will return to the previous menu.



6.7.4. Control Device

Configure the settings of the remote control and keyboard controller.

1. From <SYSTEM SETUP> - <SYSTEM>, select <CONTROL DEVICE>.
2. Use the [▲▼◀▶/ENTER] buttons on the remote control or use the mouse to set the connection options for the control device.

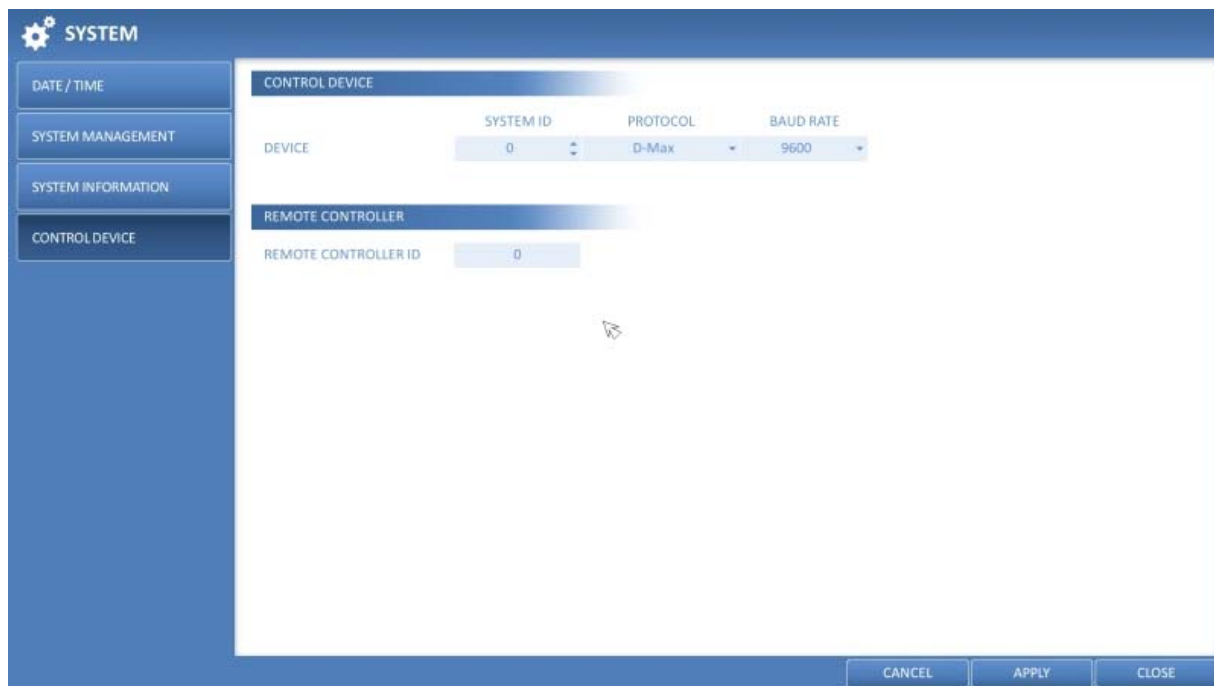

- > SYSTEM ID : Set the ID of the NVR so that the keyboard controller can identify it.
- > PROTOCOL : Set up the protocol of the keyboard controller.
- > BAUD RATE : Specify the RS485 communication speed.
- > REMOTE CONTROLLER ID : Set the ID of the remote control.

3. To apply the change, click on <APPLY> in the bottom of the screen.
4. When done, press the [EXIT] button on the remote control or click on <CLOSE> in the lower screen. The confirmation message will appear and you will return to the previous menu.

6.8. Storage

You can configure the settings and view the information of the disk and the external storage device.

6.8.1. Disk Information

It will show the information about the connected disk.

1. From <SYSTEM SETUP> - <STORAGE>, select <DISK INFORMATION>.
2. Use the [▲▼◀▶/ENTER] buttons on the remote control or use the mouse to select either <INTERNAL DISKS> or <EXTERNAL STORAGE>. Please check the status for each connected device.

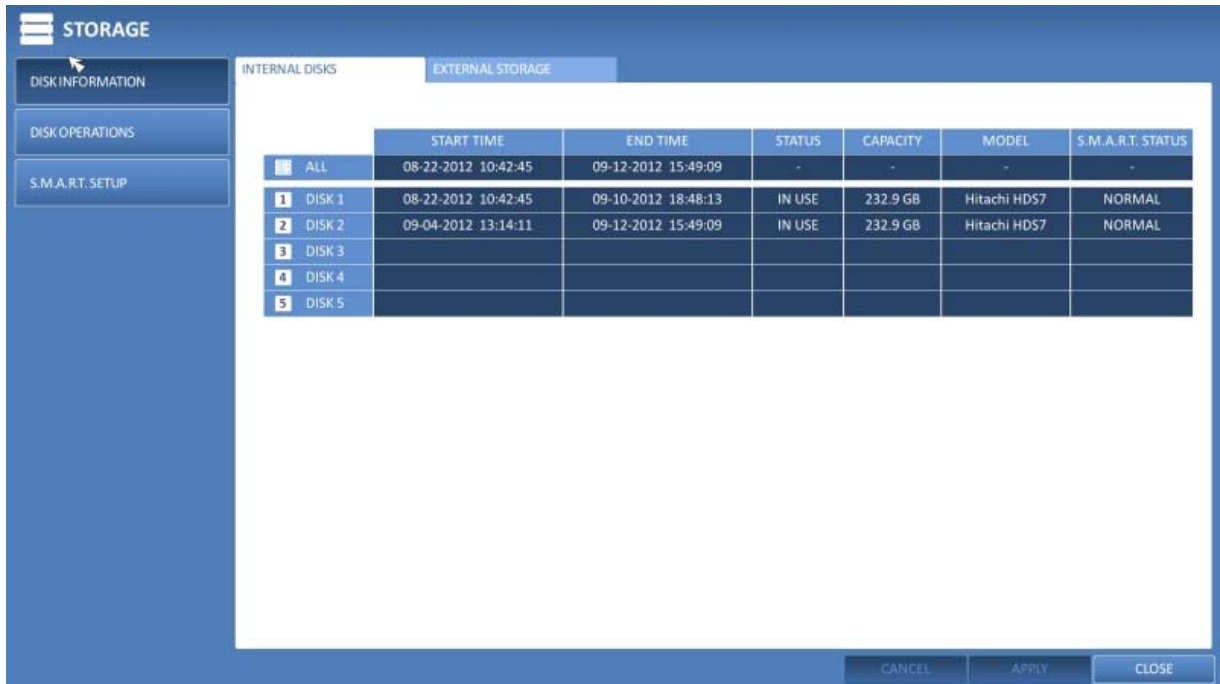

- > START / END TIME : Shows the start time and end time of data stored in each disk.
- > STATUS : Checks if the connected disk is being used by the NVR. If you encounter a problem with the disk, the NVR will terminate the connection to the disk and mark it as 'Not In Use'.
- > CAPACITY : Shows the capacity of the disk.
- > MODEL : Indicates the disk model.
- > S.M.A.R.T STATUS : Read the S.M.A.R.T information of the disk and check to display if the current disk is in normal operation.
 - NORMAL : The disk is in a normal state.
 - CHECK : The disk has an error so that you need to check the disk or the connection cables of the disk. If you leave the problem unresolved, no recording may be enabled. So it is recommended that you replace the disk immediately.
 - ERROR : The disk fails or is unable to be used due to an error of the disk or the cable. The disk should be replaced immediately. Contact the retailer or the customer service to replace the disk.

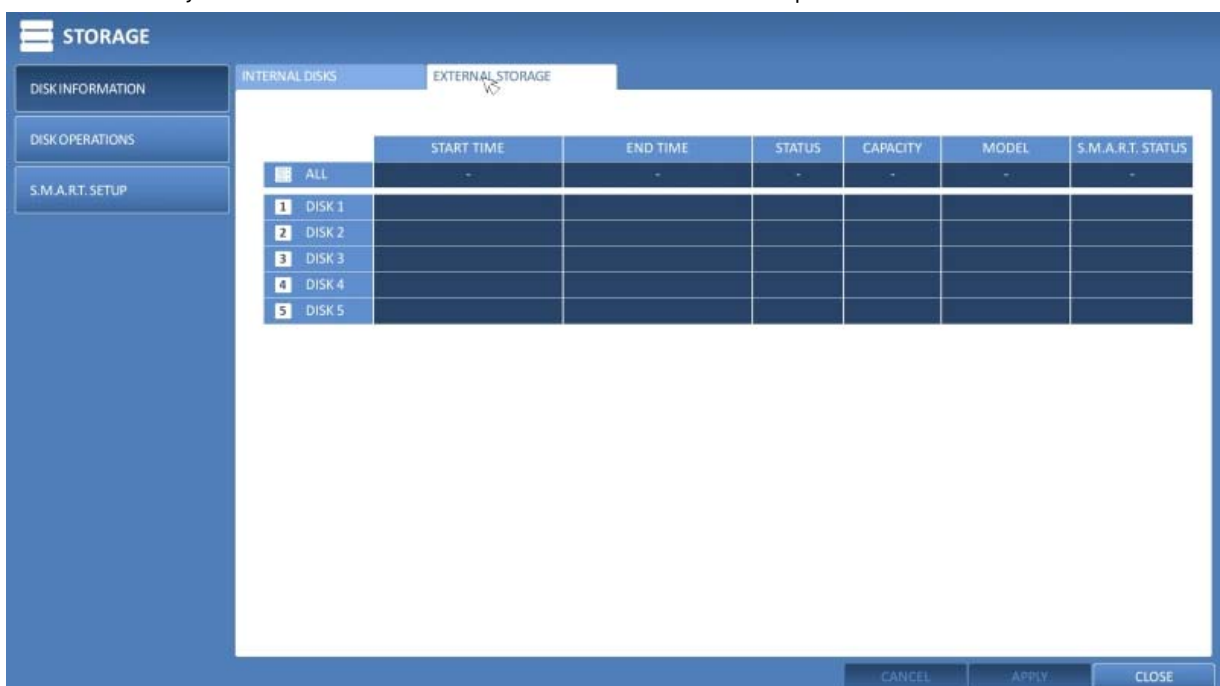

3. When done, press the [EXIT] button on the remote control or click on <CLOSE> in the lower screen to return to the previous menu.

6.8.2. Disk Operations

You can set to delete the recording automatically and set the overwrite options, and you can also format the HDD recording data.

1. From <SYSTEM SETUP> - <STORAGE>, select <DISK OPERATIONS>.
2. Use the [▲▼◀▶/ENTER] buttons on the remote control or use the mouse to set the operation conditions of the disk.

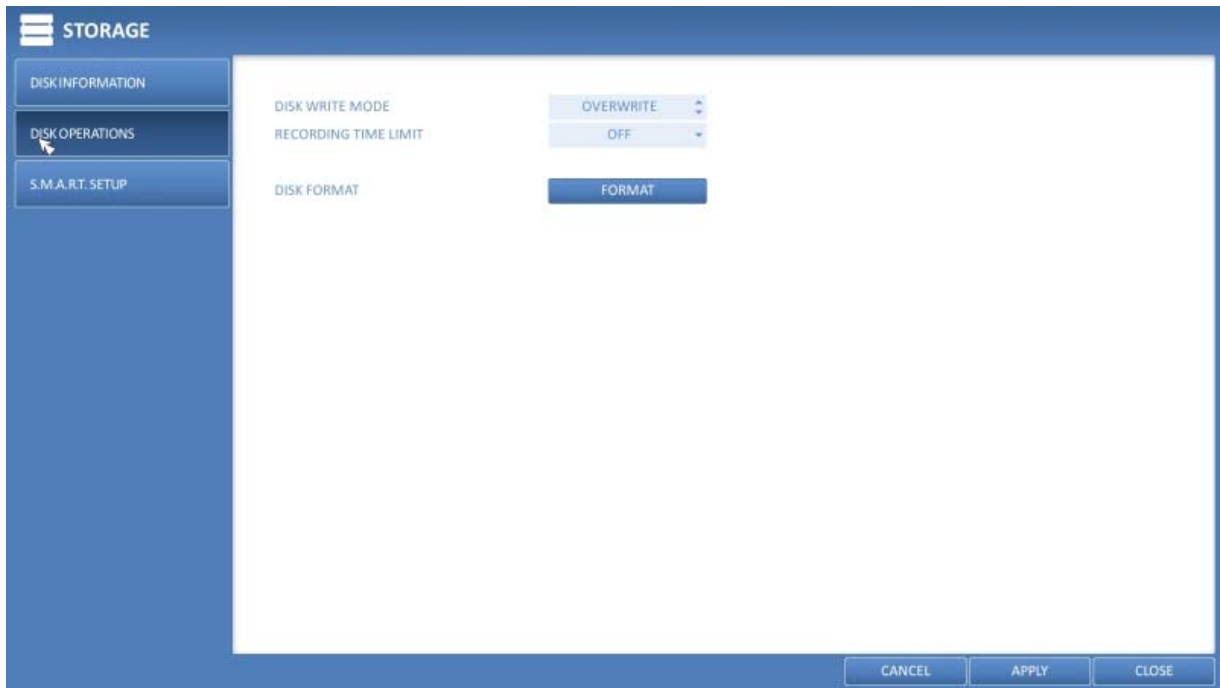

> DISK WRITE MODE :

- If it is set to <OVERWRITE>, the existing data will be overwritten by new recording data if the recording data size exceeds the free space of the HDD.

- If the option is set to <ONCE> and the HDD is full, the NVR will stop recording and output the beep or alarm that is pre-defined at <EVENT>.

> RECORDING TIME LIMIT : The recording data will be deleted after a specific time of reservation. If it is set to <OFF>, this function will be disabled.

> DISK FORMAT : Format the hard disk.

ATTENTION: Please note that formatting the HDD will delete all video data and logs.

3. To apply the change, click on <APPLY> in the bottom of the screen.

4. When done, press the [EXIT] button on the remote control or click on <CLOSE> in the lower screen. The confirmation message will appear and you will return to the previous menu.

6.8.3. S.M.A.R.T. Settings

You can check the S.M.A.R.T information of the disk and specify the check frequency.

What is the S.M.A.R.T information?

S.M.A.R.T (Self-Monitoring, Analysis and Report Technology) is to detect a HDD that is likely to cause a problem in the future with a warning message.

1. From <SYSTEM SETUP> - <STORAGE>, select <S.M.A.R.T. SETUP>.
2. Use the [▲▼◀▶/ENTER] buttons on the remote control or use the mouse to check the S.M.A.R.T. operation and specify the check interval.

> S.M.A.R.T. STATUS : Read the S.M.A.R.T. information of the disk and check to display if the current disk is in normal operation. Click on <DETAIL INFO> to view the details.

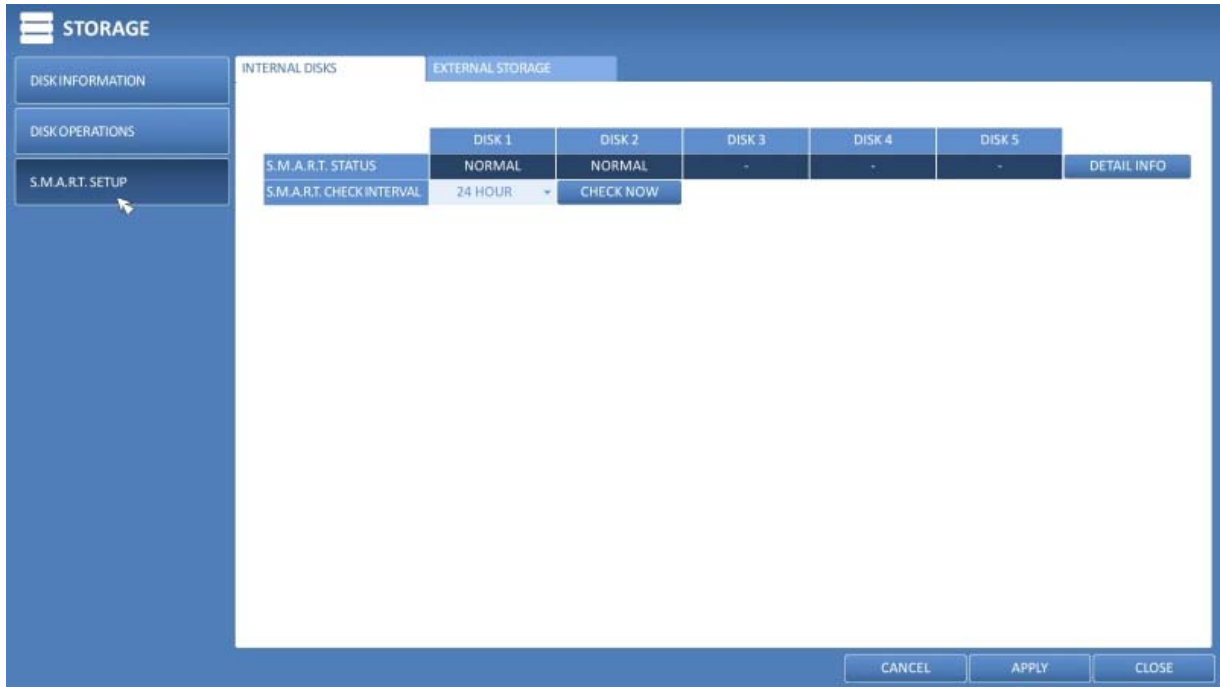

- NORMAL : The disk is in a normal state.
 - CHECK : The disk has an error so you need to check the disk or the connection cables of the disk. If you leave the problem unresolved, the recording might be disabled. Therefore, it is recommended that you replace the disk immediately.
 - ERROR : The disk fails or is unable to be used due to an error of the disk or the cable. The disk should be replaced immediately. Contact the retailer or the customer service to replace the disk.
- > S.M.A.R.T CHECK INTERVAL : Specify the S.M.A.R.T check interval. Click on <CHECK NOW> to start checking.

3. To apply the change, click on <APPLY> in the bottom of the screen.
4. When done, press the [EXIT] button on the remote control or click on <CLOSE> in the lower screen. The confirmation message will appear and you will return to the previous menu.

6.9. Event Setup

Define various events, and specify the conditions for notifying the user in various ways.

6.9.1. Alarm Out

Specify the alarm output conditions with the work schedule.

Alarm Out :

1. From <SYSTEM SETUP> - <EVENT>, select <ALARM OUT>.
2. Use the [▲▼◀▶/ENTER] buttons on the remote control or use the mouse to select <ALARM OUT> and configure the related settings.



- > NAME : You can rename the alarm.
- > OPERATION : Set the alarm output mode.
 - N/O (Normal Open) : It normally stays as Open. However, if an event occurs, it will switch to Close.
 - N/C (Normal Close) : It normally stays as Close. However, if an event occurs, it will switch to Open.
- > DURATION : Specify the duration of the alarm output.
 - TRANSPARENT : Keep the alarm out for as much time as the event lasts.
 - UNTIL KEY : Keep the alarm out until a mouse or remote control button is pressed.
 - 5 ~ 300 SEC : Keep the alarm for as long as specified.
- > TEST : Forcibly output the alarm for a test purpose.

3. To apply the change, click on <APPLY> in the bottom of the screen.

4. When done, press the [EXIT] button on the remote control or click <CLOSE> in the lower screen. The confirmation message will appear and you will return to the previous menu.

ON/OFF Schedule :

You can activate or turn the alarm output off as scheduled.

1. Use the [▲▼◀▶/ENTER] buttons on the remote control or use the mouse to select a <DATE> for the schedule.
2. Drag the mouse to resize the cell or use the [▲▼◀▶] buttons to move to the cell, then press [ENTER].

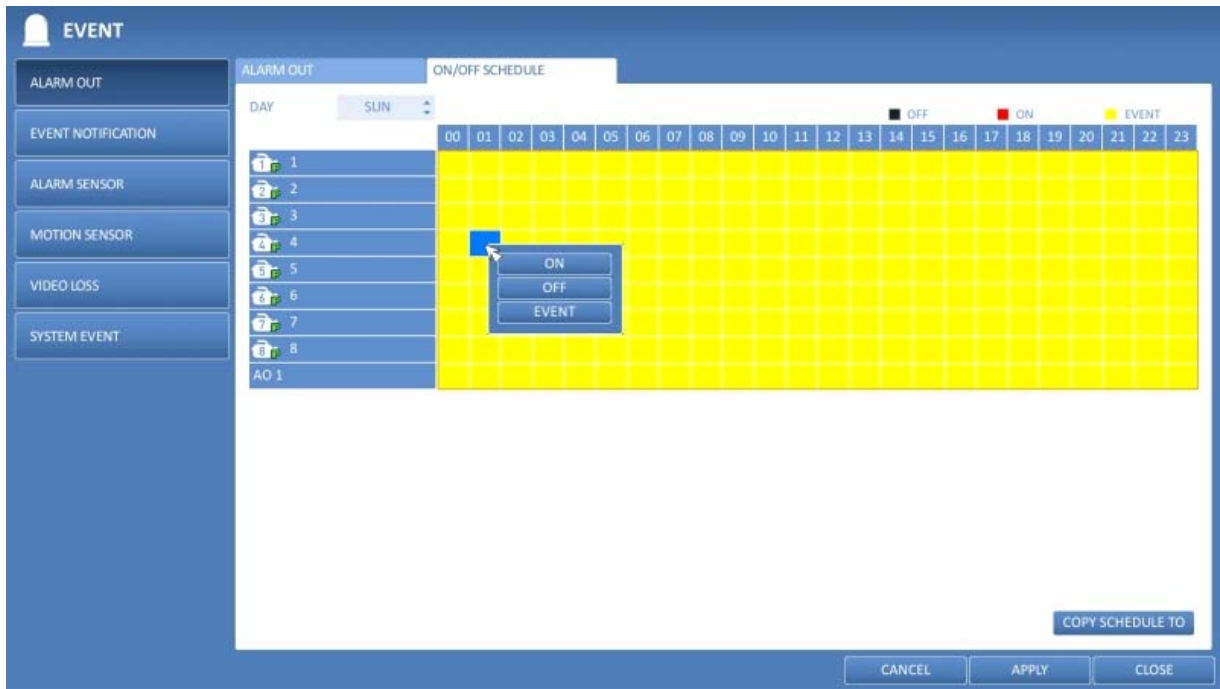

3. Select a desired alarm output mode.

- > ON : The alarm output is always turned on.
- > OFF : The alarm output is always turned off.
- > EVENT : Trigger the alarm output in synchronisation with the event.

4. Click on <COPY SCHEDULE> to check the checkbox of the date that you want to copy the schedule at.
5. When done, click <OK> to apply the settings.
6. To apply the change, click <APPLY> in the bottom of the screen.
7. When done, press the [EXIT] button on the remote control or click on <CLOSE> in the lower screen. The confirmation message will appear and you will return to the previous menu.

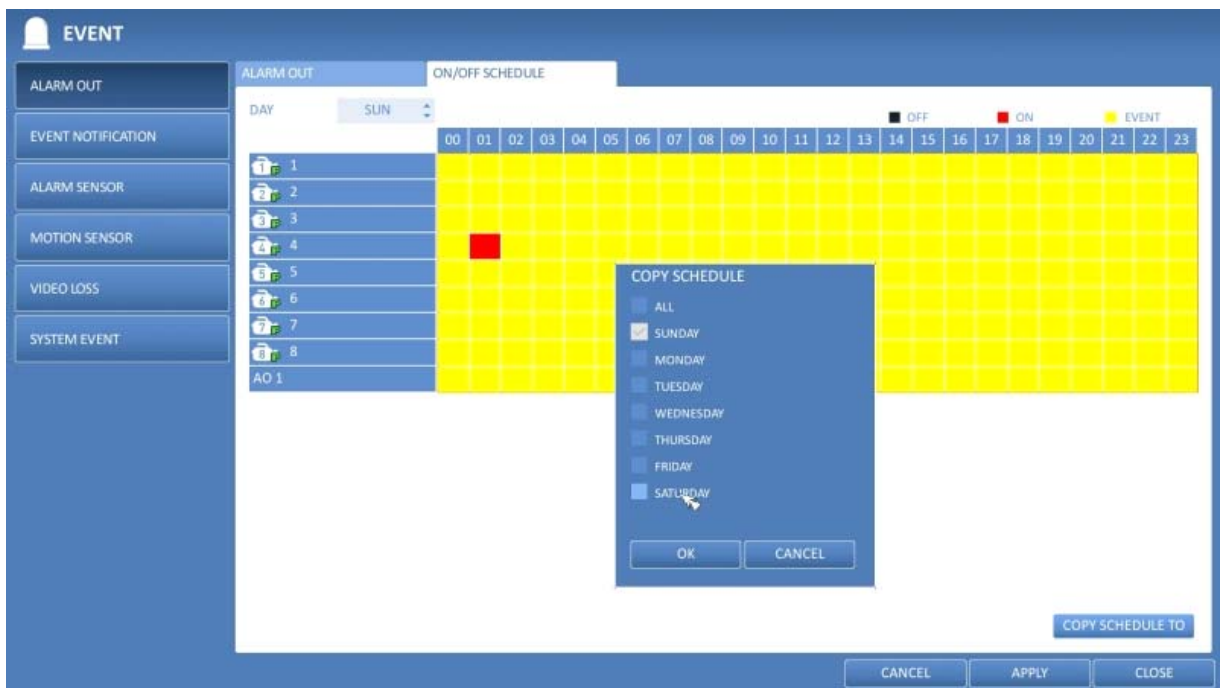

6.9.2. Event Notification

Specify the methods of notification such as the buzzer, video pop-up or email if an event occurs.

1. From <SYSTEM SETUP> - <EVENT>, select <EVENT NOTIFICATION>.
2. Use the [▲▼◀▶] buttons on the remote control or use the mouse to select one option from <BUZZER>, <DISPLAY> and <EMAIL>.
3. Use the [▲▼◀▶/ENTER] buttons on the remote control or use the mouse to set the output method and duration.
4. To apply the change, click on <APPLY> in the bottom of the screen.
5. When done, press the [EXIT] button on the remote control or click on <CLOSE> in the lower screen. The confirmation message will appear and you will return to the previous menu.

Buzzer output :

You can notify the user of the event using the buzzer.

> DURATION :

- TRANSPARENT : Keep the buzzer out for as long as the event lasts.
- UNTIL KEY : Keep the buzzer out until a mouse or remote control button is pressed.
- 5 ~ 300 SEC : Keep the buzzer out for as long as specified.

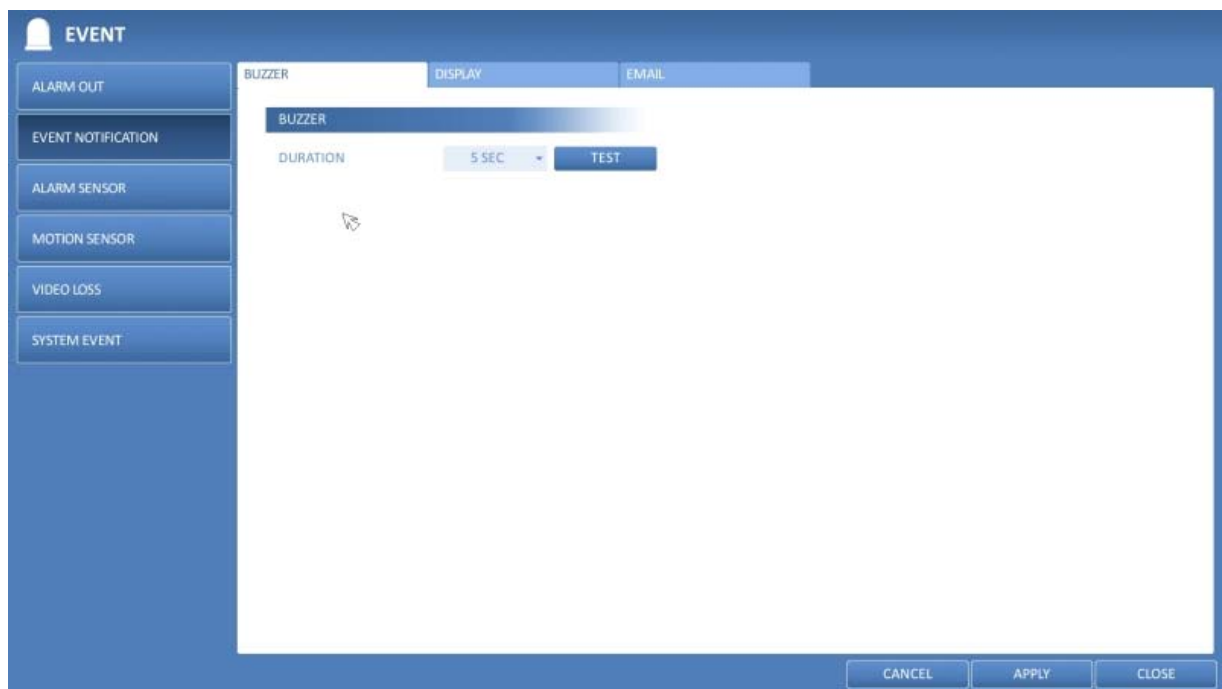

Display :

If an event occurs, you can display the video screen or a pop-up message to notify the user of the event.

> VIDEO POP-UP : Display the video channel that is synchronised with the event on a single split screen. Set the DURATION of the single split screen.

- TRANSPARENT : Keep the video pop-up displayed for as much time as the event lasts.
- UNTIL KEY : Keep the video pop-up displayed until a mouse or a remote control button is pressed.
- 5 ~ 300 SEC : Keep the video pop-up displayed for as long as specified.

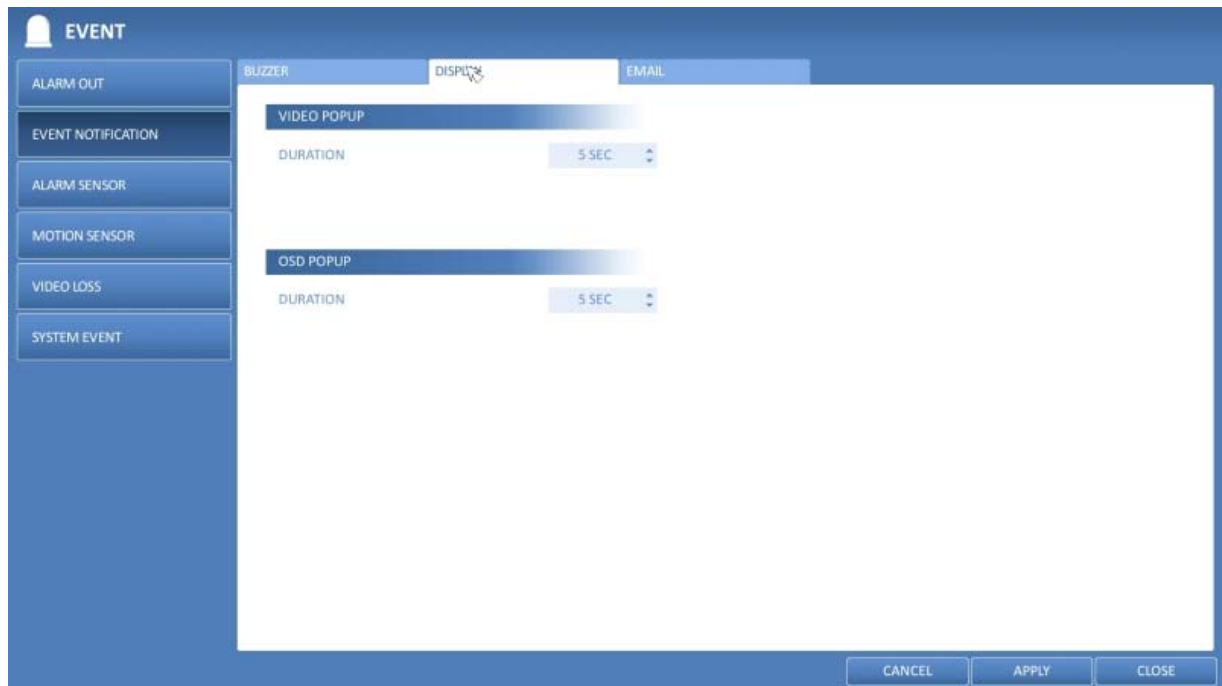

NOTE: If multiple events occur at the same time, or if multiple event-related video channels exist, the video pop-up will be displayed in the maximum split screen mode rather than the single split screen mode.

> OSD POPUP : This will notify the user of the event with a pop-up message if an OSD pop-up event occurs. You can adjust the duration of the popup message.

- UNTIL KEY : Keep the OSD pop-up displayed until a mouse or remote control button is pressed.
- 5 ~ 300 SEC : Keep the OSD pop-up displayed for as long as specified.

Email :

If an event occurs, this will notify the registered users of the event by email. If you do not want to receive this email, uncheck the <EMAIL NOTIFY> option in <MANAGEMENT> (Chapter 6.5.1. Management).

> ADD NEW EMAIL : If you want to add a new mail recipient beside the existing ones, click on this to add the recipient.

> MINIMUM EMAIL FREQUENCY : Adjust the minimum frequency for sending the email. For example, even if you have set the minimum frequency to one minute and another event occurs in less than one minute after the last sent email, the email for the new event will be sent one minute after the previous one.

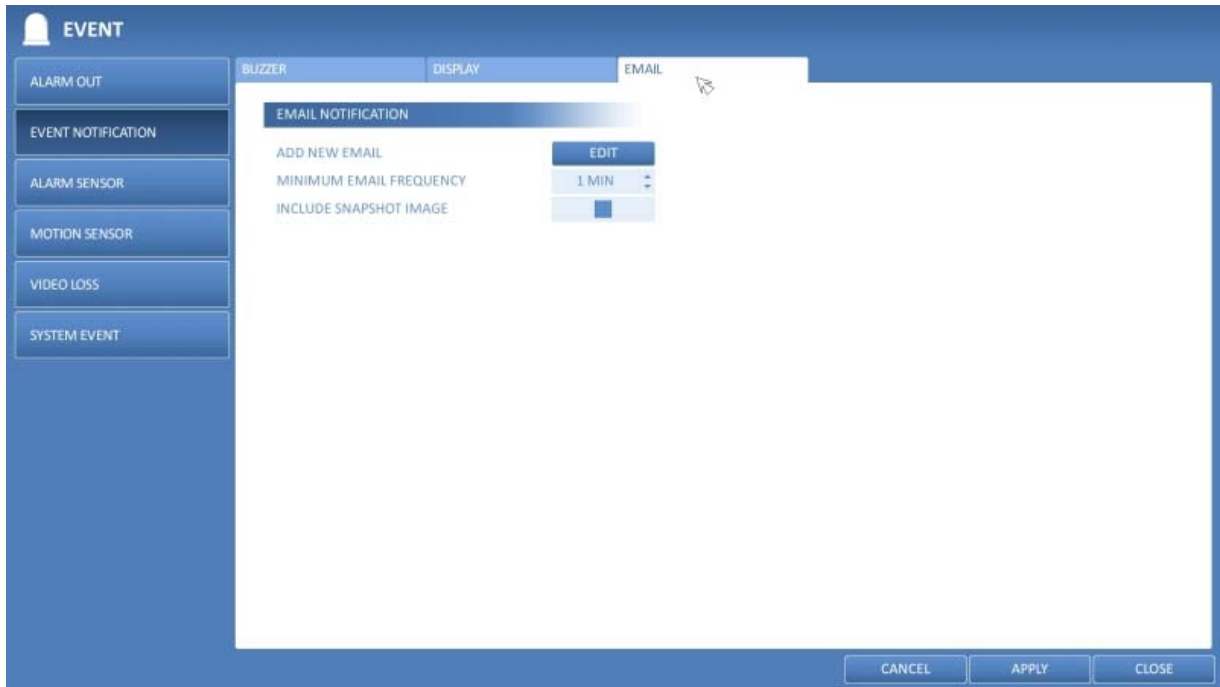

NOTE: Some email servers can block the sending of the email if the email delivery cycle is too short, and classify it as spam. Contact your email service provider to adjust the minimum delivery cycle, so that the server does not classify the email as spam.

6.9.3. Alarm Sensor

You can configure the settings of the alarm sensor and specify the operation of the sensor if an event occurs.

1. From <SYSTEM SETUP> - <EVENT>, select <ALARM SENSOR>.
2. Use the [▲▼◀▶] buttons on the remote control or use the mouse to specify the sensor input method and operation.



- > NAME : You can specify the name of the alarm sensor.
- > OPERATION : You can specify the type of the alarm sensor.
 - N/O (Normal Open) : Normally the sensor is left as Open. If the sensor switches to Close, an event will be triggered.
 - N/C (Normal Close) : Normally the sensor is left as Close. If the sensor switches to Open, an event will be triggered.
- > LINKED CAMERA : Set the camera to synchronise with the alarm sensor when the sensor is triggered. If you have set the alarm recording and the sensor detects the recording, all synchronised cameras will start the alarm recording.
- > PRESET : On alarm sensor's detections, the camera moves as defined by the selected preset.
- > ALARM OUTPUT : Specify the alarm output channel to be used in the case of a detection by the alarm sensor. The alarm will be output to the specified channel.
- > BUZZER : Specify the output of the buzzer if an alarm is detected by the alarm sensor.
- > VIDEO POPUP : Select to display the video pop-up if an alarm is detected by the alarm sensor. If there exist multiple <LINKED CAMERA>s, the video pop-up will be displayed in the maximum split mode.
- > OSD POPUP : Select to display the OSD popup message to show in the case of a detection by the alarm sensor.
- > EMAIL : Select to send an email if a detection by the alarm sensor occurred.

3. To apply the change, click on <APPLY> in the bottom of the screen.

4. When done, press the [EXIT] button on the remote control or click on <CLOSE> in the lower screen. The confirmation message will appear and you will return to the previous menu.

6.9.4. Motion Sensor

You can set an action to execute when a motion is detected. For the settings of the motion sensor, move to <CAMERA SETUP>.

1. From <SYSTEM SETUP> - <EVENT>, select <MOTION SENSOR>.
2. Use the [▲▼◀▶] buttons on the remote control or use the mouse to specify the ignorance interval and operation.

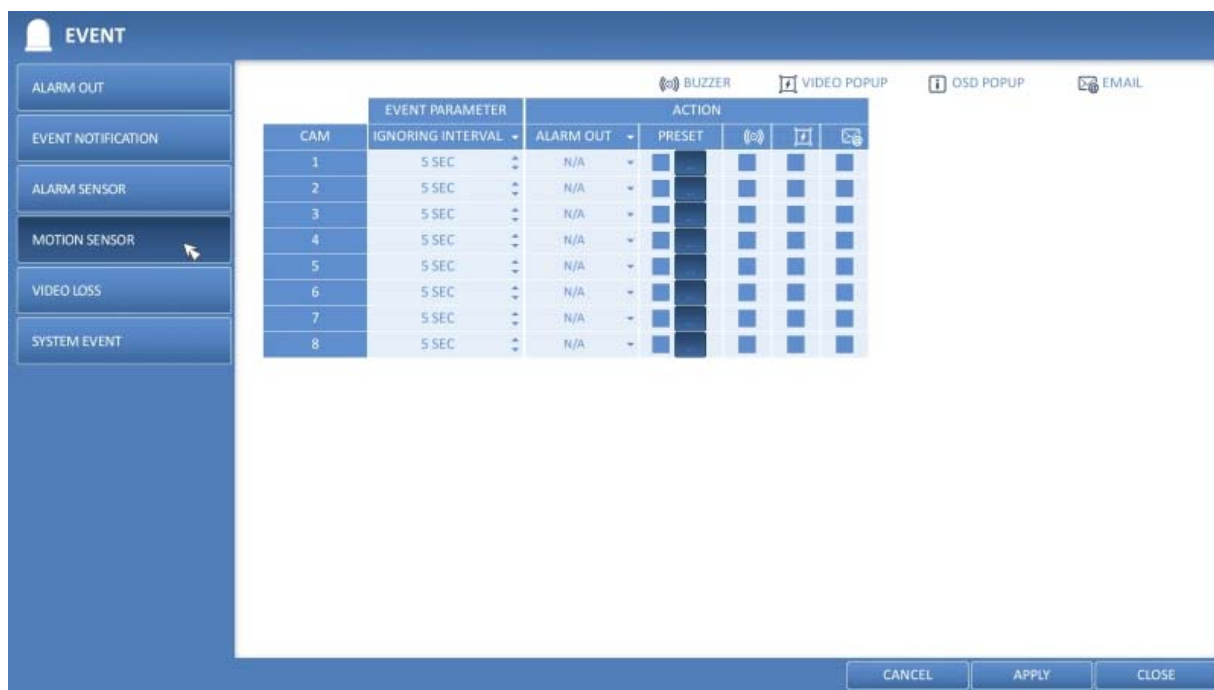

> **IGNORING INTERVAL** : Specify the minimum interval of the motion event occurrence. For example, even if you have set the minimum frequency to 5 seconds and another motion event occurs in less than 5 seconds after the last motion event occurred, the new event will be ignored. If too many motion events occur, adjust the setting to shorten the interval.

NOTE : Motion recording will be triggered immediately after the motion occurred regardless of the above settings.

> **ALARM OUTPUT** : Specify the alarm output channel if a motion is detected by the motion sensor.

> **BUZZER** : Specify the output of the buzzer if a motion is detected by the motion sensor.

> **VIDEO POPUP** : Select to display the video pop-up if a motion is detected by the motion sensor.

> **EMAIL** : Select to send an email if a motion is detected by the motion sensor.

3. To apply the change, click on <APPLY> in the bottom of the screen.

4. When done, press the [EXIT] button on the remote control or click on <CLOSE> in the lower screen. The confirmation message will appear and you will return to the previous menu.

6.9.5. Video Loss

You can specify a reaction to the case where no video is received from the camera.

1. From <SYSTEM SETUP> - <EVENT>, select <VIDEO LOSS>.

2. Use the [▲▼◀▶] buttons on the remote control or use the mouse to specify the reaction to a video loss.

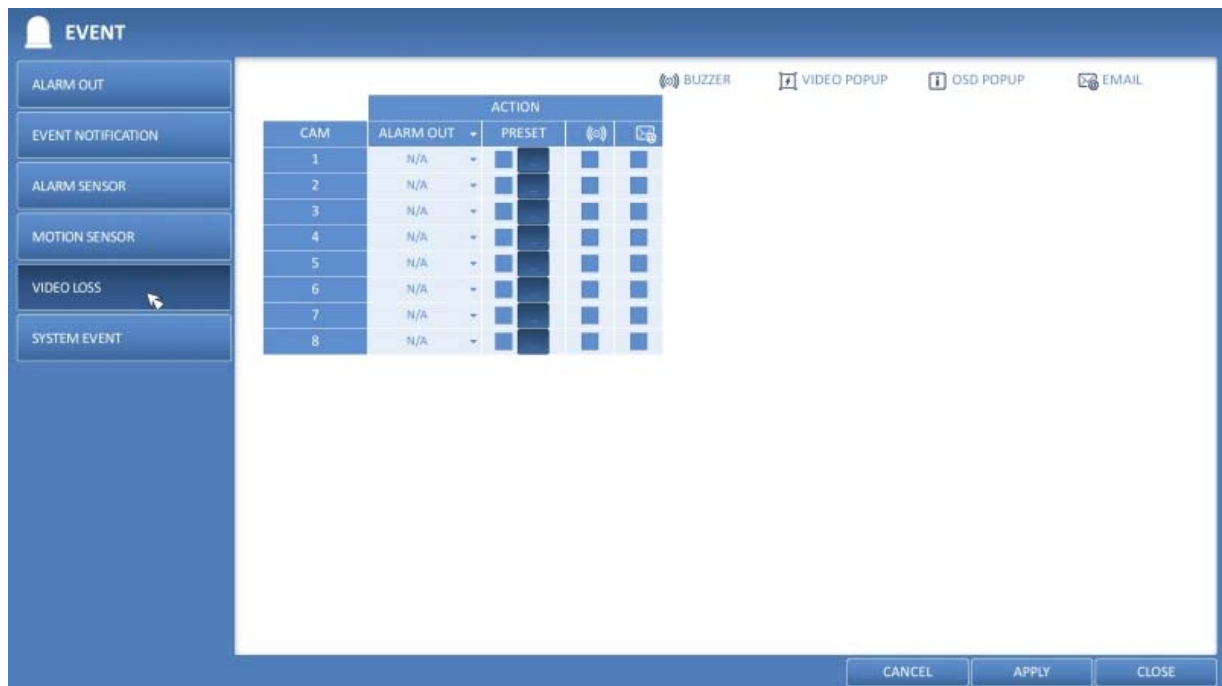

> **ALARM OUTPUT** : Specify the alarm output channel if a video loss occurs.

> **BUZZER** : Specify the output of the buzzer if a video loss occurs.

> **EMAIL** : Select this to send an email out if a video loss occurs.

3. To apply the change, click on <APPLY> in the bottom of the screen.

4. When done, press the [EXIT] button on the remote control or click on <CLOSE> in the lower screen. The confirmation message will appear and you will return to the previous menu.

6.9.6. System Event

You can set any action to an event related to disk, recording, network or system. Like the other events, you may notify the users of the event using the alarm/buzzer output, OSD pop-up or email.

1. From <SYSTEM SETUP> - <EVENT>, select <SYSTEM EVENT>.
2. Use the [▲▼◀▶] buttons on the remote control or use the mouse to specify the reaction to each event.
3. To apply the change, click on <APPLY> in the bottom of the screen.
4. When done, press the [EXIT] button on the remote control or click on <CLOSE> in the lower screen. The confirmation message will appear and you will return to the previous menu.

Disk :

- > START DISK OVERWRITE : If you set the disk write mode to <OVERWRITE>, this event occurs when the disk is full and the overwriting begins accordingly.
- > DISK FULL EVENT : If you set the disk write mode to <ONCE>, this event occurs when the disk is full (100%).
- > DISK SPACE EXHAUSTED : Event that is triggered if the disk is almost full. Click to specify the threshold percentage of usage to trigger the event.
- > S.M.A.R.T. EVENT : Occurs if the disk causes the S.M.A.R.T. error.
- > NO DISK : Occurs if no disk is recognised after booting due to a disk failure or cable problem.

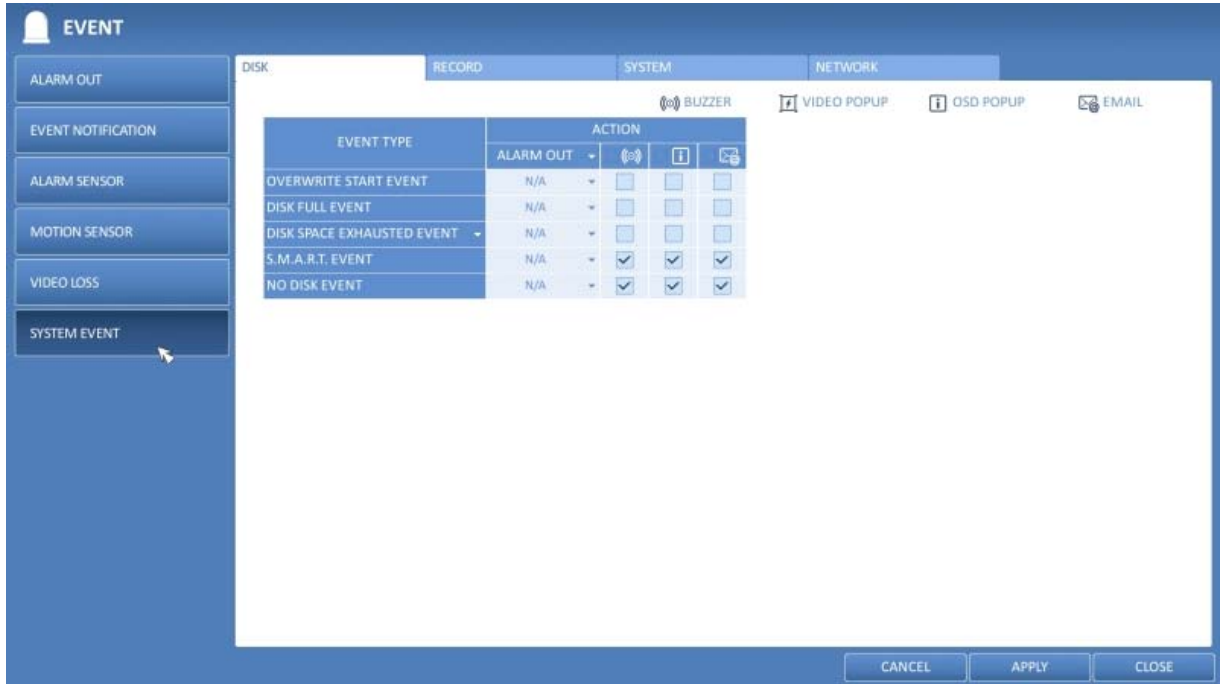

NOTE: To detect a disk error, it is recommended not to change the settings of S.M.A.R.T. EVENT, NO DISK EVENT and BUZZER OUT.

Record :

> PANIC RECORDING : Specify the action to perform when the panic recording begins.

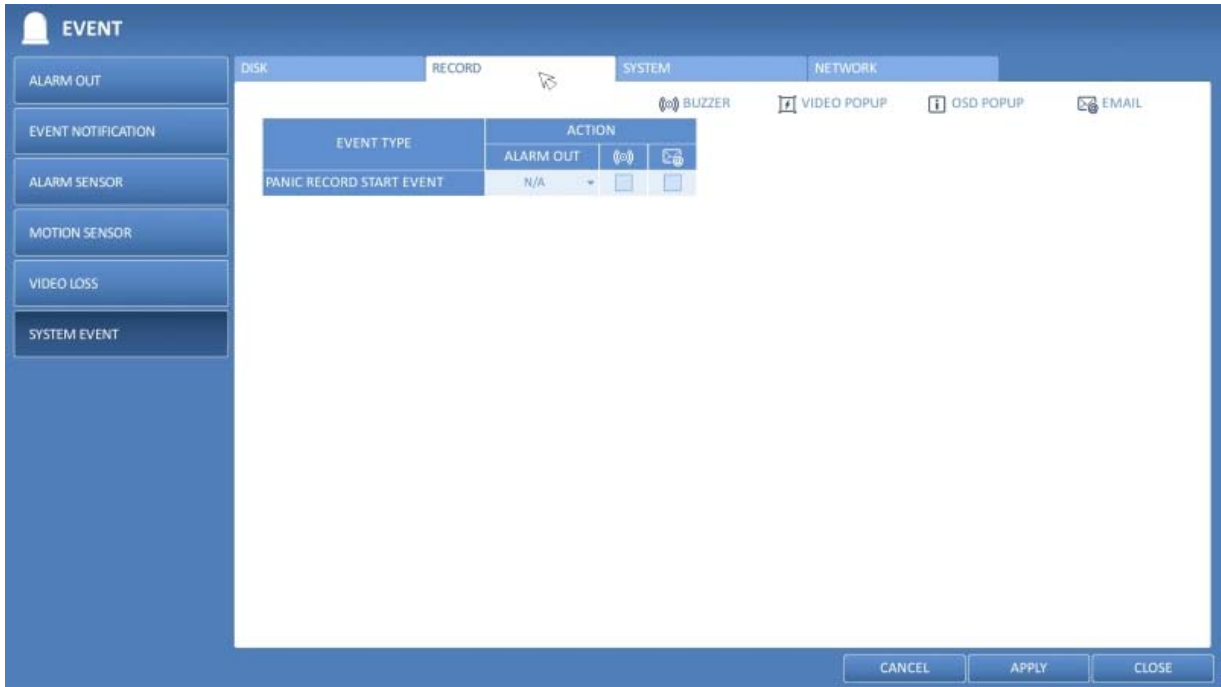

System :

> BOOTING EVENT: This event occurs when the NVR is booting.

> LOGIN FAILURE: This event occurs when the NVR fails to log in. You can specify the number of failed registrations for triggering the event by clicking the 'Arrow Down' Button.

> FAN ERROR EVENT : This event occurs if the CPU cooling fan or unit's cooling fan does not work at all.

NOTE : If the fan fails, the NVR will not proceed with the recording. If you encounter a fan failure, contact the retailer or the service center for technical assistance.

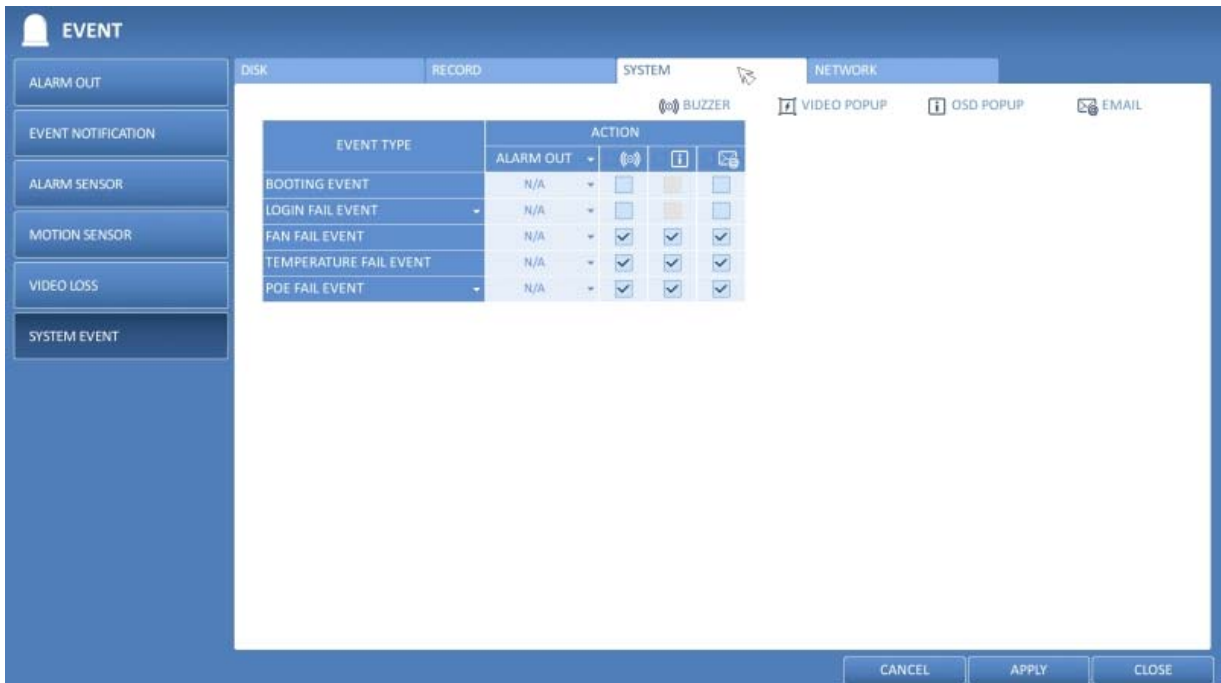

- > TEMPERATURE FAILURE : This event occurs if the internal temperature of the NVR exceeds the allowed range. Then, the NVR will not operate normally. If this is the case, check the following and take an adequate measure.
 - Check if the ventilation of the NVR is clogged with foreign substances. If so, remove them.
 - Keep the NVR away from a heat source such as a heater. Install it in a flat, lower area with good ventilation.
 - If the problem persists, contact the retailer or service center.
- > POE FAIL EVENT* : This event occurs if the power consumption reaches the specified level of the power supply capacity of the NVR and the External PoE Hub*.

*Only for the 16Ch NVR model GRI-K4416A.

NOTE: To monitor the normal operation of the NVR, it is recommended not to change the buzzer output settings of the fan failure event and the temperature failure event.

Network :

- > TROUBLE IN INTERNET CONNECTION : Occurs if the Internet connection to the NVR fails. If you do not want to connect the NVR to the network, leave the <Action> item blank.
- > FAILURE IN REMOTE LOGIN : This event occurs if a remote client fails to log in due to an invalid ID or password. You can specify the number of failed registrations for triggering the event by clicking on the 'Arrow Down' button.
- > FAILURE IN DDNS UPDATE : This event occurs if the NVR tried to update the DDNS address but failed.

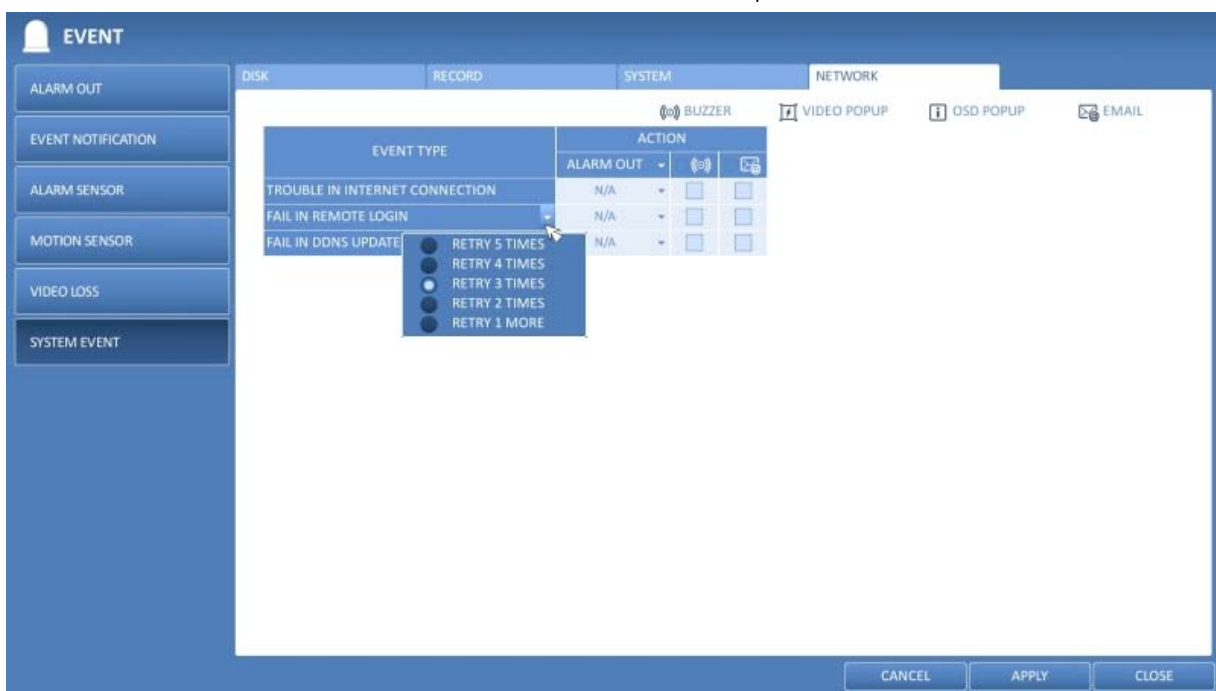

NOTE: If the DDNS address fails to be updated, the NVR may not connect to a remote client. If this is the case, enter the IP address from the client side to allow access from the NVR. This is just a temporary measure. For the IP address, move to <EXTERNAL IP ADDRESS> and check the <EXTERNAL IP ADDRESS> from the <NETWORK> window.

ATTENTION: Please be aware that the <EXTERNAL IP ADDRESS> can change at any time in a dynamic IP environment.

7. Record Setting

You can configure the record settings for the NVR. Only authorised users can access the Record Setup menu.

7.1. Starting the Record Setup Menu

> How to use the mouse :



> How to use the remote control :



7.2. Record Setup

7.2.1. Operation Mode

You can set the recording options for Auto or Manual mode here.

1. From <RECORD SETUP> menu, select <OPERATION MODE>.
2. Use the [▲▼◀▶] buttons or use the mouse to set <RECORD SETUP MODE> to <AUTO CONFIGURATION> or <MANUAL CONFIGURATION>.
3. Set the recording options for each selected Record mode.
4. To apply the change, click on <APPLY> in the bottom of the screen.
5. When done, press the [EXIT] button on the remote control or click on <CLOSE> in the lower screen. The confirmation message will appear and you will return to the previous menu.

Auto Configuration :

If you choose this as your preferred record mode, the NVR will recommend to you the optimised settings for the selected record mode.

- > ALWAYS HIGH VIDEO QUALITY : Recording will proceed in the best quality regardless of the event at all times. As this option will always create recordings in the best quality, the recording period is the shortest compared to the other record modes.
- > MOTION RECORD : The recording will only proceed if a motion is detected.
- > ALARM RECORD : The recording will only proceed if an alarm event occurs.
- > MOTION/ALARM RECORD : The recording will only proceed if a motion is detected or an alarm event occurs.
- > INTENSIVE MOTION RECORD : Normally the recording will be performed in a low quality. However, the quality will switch to high if a motion is detected.
- > INTENSIVE ALARM RECORD : Normally the recording will be performed in a low quality. However, the quality will switch to high if an alarm event occurs.
- > INTENSIVE MOTION/ALARM RECORD : Normally the recording will be performed in a low quality. However, the quality will switch to high if an alarm event occurs or a motion is detected.

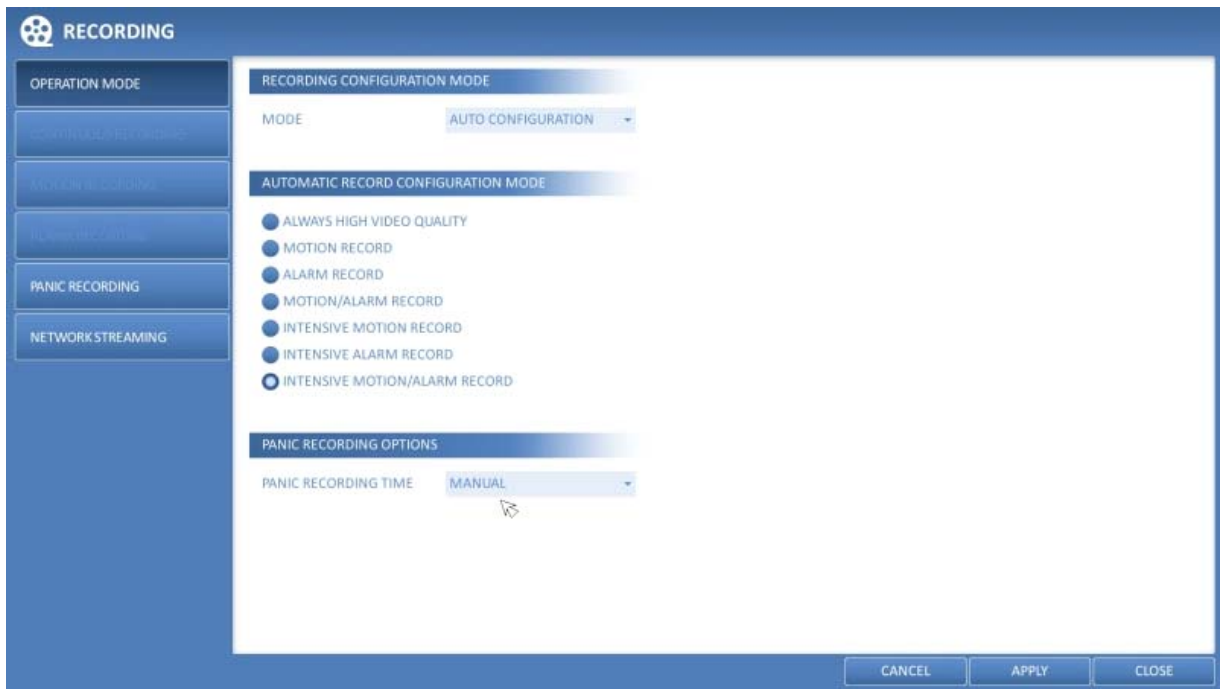

Manual Configuration :

If you set the record mode to <MANUAL CONFIGURATION>, the manual configuration window will appear where you can set the manual recording and panic recording options.

- > MANUAL CONFIGURATION OPTIONS : You can configure the recording settings by time, date, and channel.
 - SCHEDULE MODE : Set the recording schedule for a day (daily) or for a week (weekly).
 - PRE RECORDING TIME : Set the pre-recording time.
 - POST RECORDING TIME : Set the post-recording time.
- > PANIC RECORDING OPTIONS : Set the panic recording duration. If it is set to <MANUAL CONFIGURATION>, recording will continue until you turn it off manually.



7.2.2. Continuous Recording

You can configure here the settings of: continuous recording time, recording size, frame rate per second and quality.

1. From the <RECORD SETUP> menu, select <CONTINUOUS RECORDING>.

NOTE: From <OPERATION MODE>, you must set <RECORD SETUP MODE> to <MANUAL CONFIGURATION> before you can set <CONTINUOUS RECORDING>.

2. Use the [▲▼◀▶] buttons on the remote control or use the mouse to select either <SIZE/FPS/QUALITY> or <SCHEDULE>.

Size/FPS/Quality Setting :

1. Please select the day of the week to perform the continuous recording. From <OPERATION MODE>, you must set the <SCHEDULE MODE> of the <MANUAL RECORD OPTION> to <WEEKLY> before you can specify the <DAY>.
2. Click a time cell from which you want to edit the SIZE/FPS/Quality and drag it to a desired cell. Or use the [▲▼◀▶] buttons on the remote control to move to the cell and press [ENTER]. Then, use the [▲▼◀▶] buttons to move to a desired cell and press [ENTER] again.

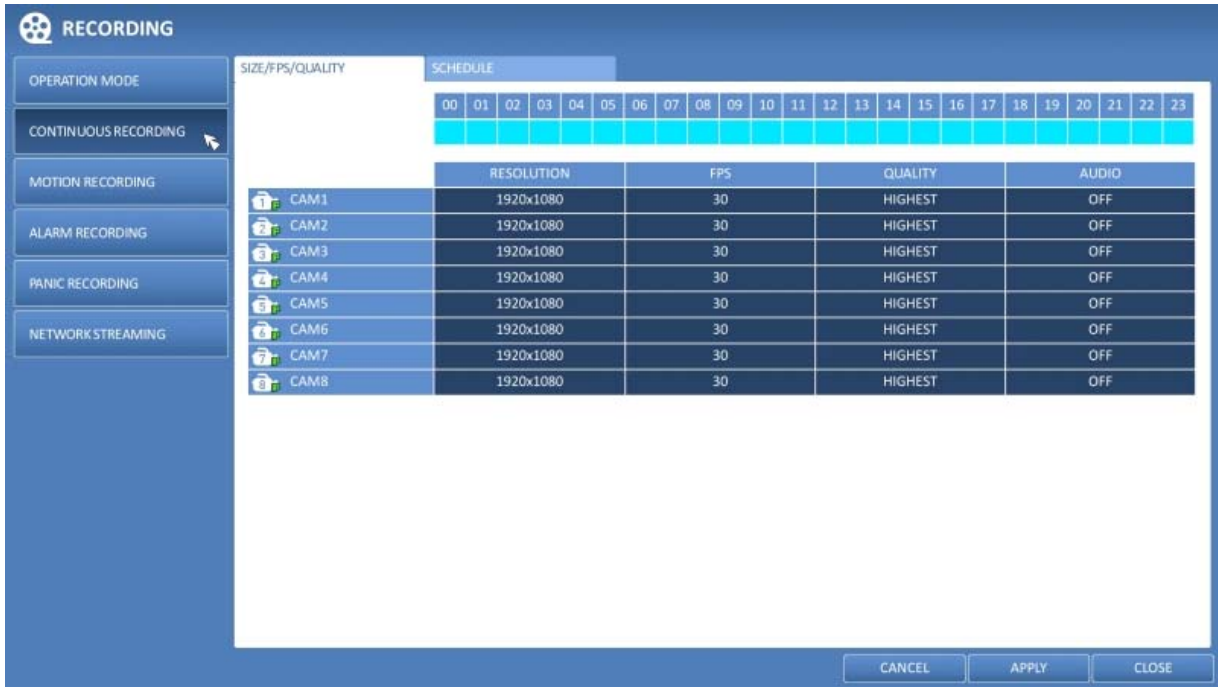

3. When the cell selection is complete, the "SIZE/FPS/QUALITY" table appears.

IMPORTANT: Specify the <RESOLUTION>, <FPS>, <QUALITY> and use of the <AUDIO> recording for each channel.

- > RESOLUTION : Set the size of the video recording.
- > FPS : Set the frame rate per second.
- > QUALITY : Set the recording quality.

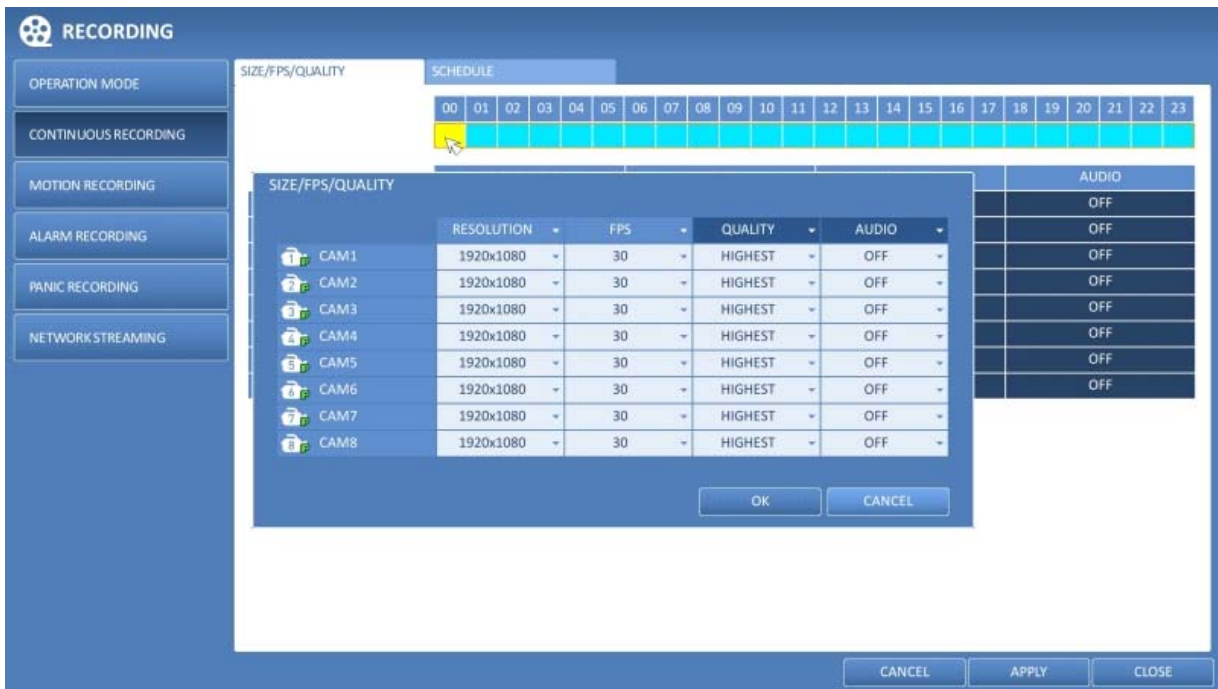

4. When done, click on <OK>. You can check the recording size in the size table under the time selection bar.

ATTENTION: The video size, FPS, quality and audio recording options may differ depending on the specification of the IP camera. For some IP cameras, the video transfer may be interrupted if some of the options are changed.

Schedule Setting :

1. Select a start day of the week on the schedule.
2. Click on a time cell from which you want to start the schedule and drag it to a desired cell. Or use the [▲▼◀▶] buttons on the remote control to move to the cell and press [ENTER]. Then, use the [▲▼◀▶] buttons to move to a desired cell and press [ENTER] again.
3. When the time selection is complete, you will be prompted to specify the use of the recording in the Record Setup window.

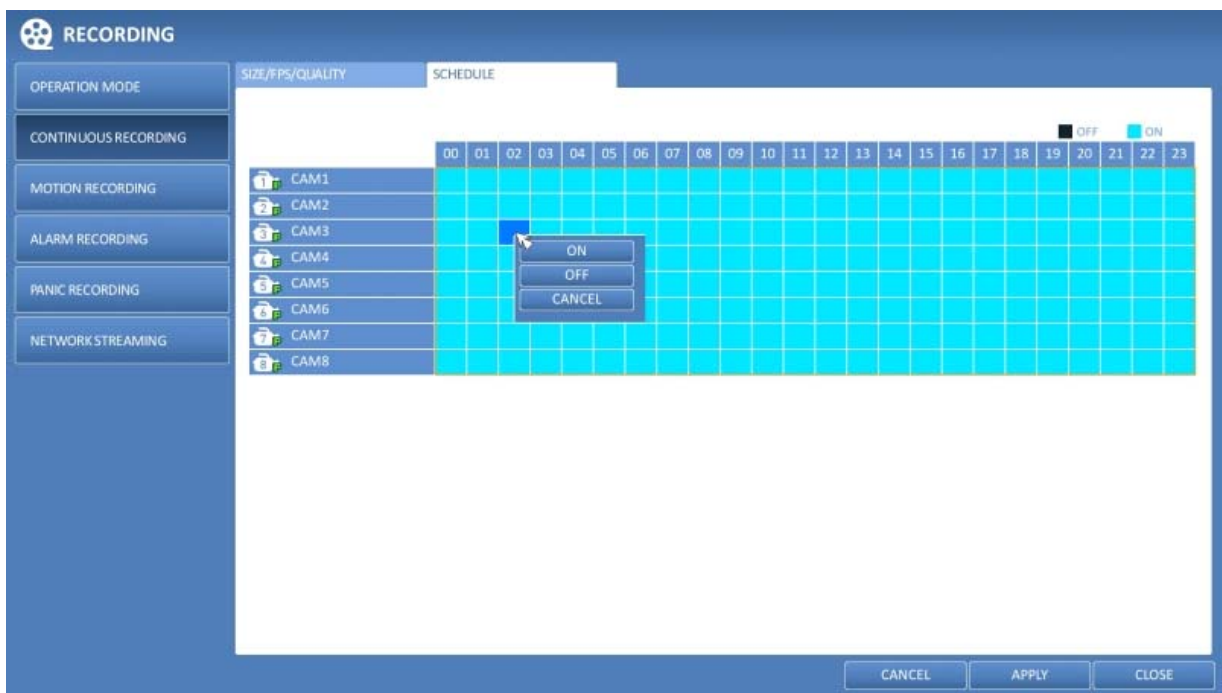

4. To apply the change, click on <APPLY> in the bottom of the screen.

5. When done, press the [EXIT] button on the remote control or click on <CLOSE> in the lower screen. The confirmation message will appear and you will return to the previous menu.

7.2.3. Motion Recording

Specify the recording size of the motion event if it occurs and create a schedule for that recording.

1. From the <RECORD SETUP> menu, select <MOTION RECORD>.
2. Use the [▲▼◀▶] buttons on the remote control or use the mouse to select either <SIZE/FPS/QUALITY> or <SCHEDULE>.
3. Set each item of <RESOLUTION>, <FPS>, <QUALITY> and use of the <AUDIO> for the motion recording.

NOTE: For more information, see Chapter 7.2.2. Continuous Recording.

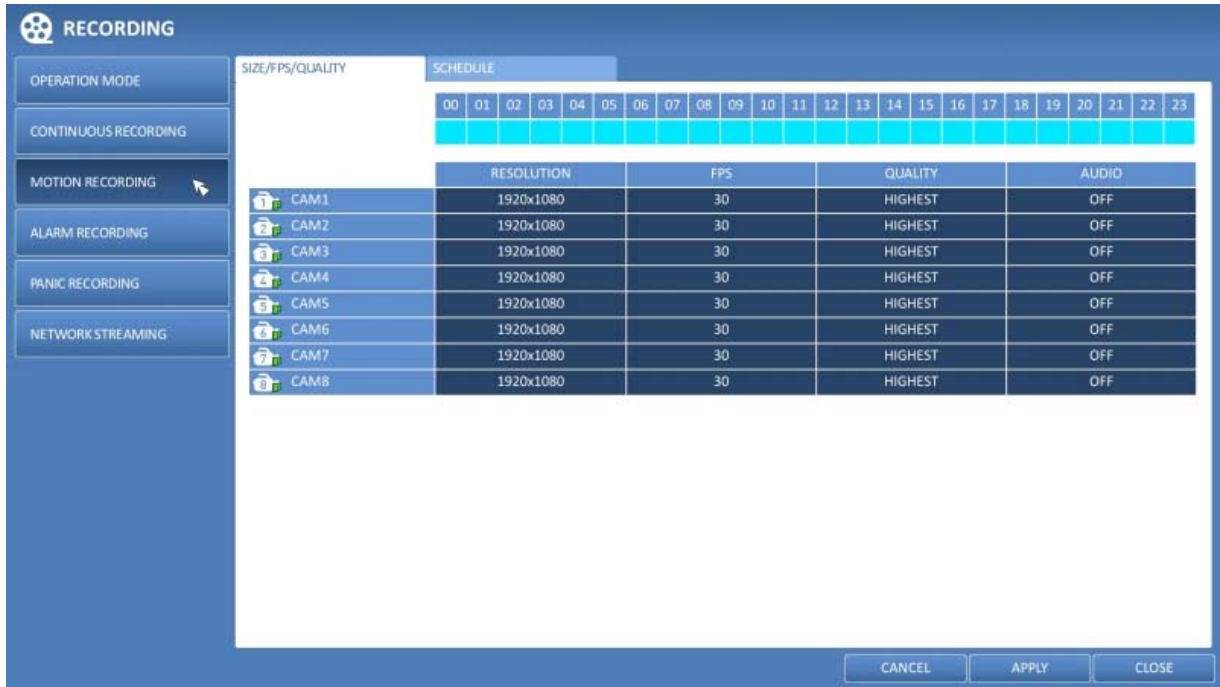

4. To apply the change, click on <APPLY> in the bottom of the screen.
5. When done, press the [EXIT] button on the remote control or click on <CLOSE> in the lower screen. The confirmation message will appear and you will return to the previous menu.

7.2.4. Alarm Recording

Specify the recording size of the alarm event if it occurs and create a schedule for that recording.

1. From the <RECORD SETUP> menu, select <ALARM RECORD>.
2. Use the [▲▼◀▶] buttons on the remote control or use the mouse to either select <SIZE/FPS/QUALITY> or <SCHEDULE>.
3. Set each item of <RESOLUTION>, <FPS>, <QUALITY> and use of the <AUDIO> for the alarm recording.

NOTE: For more information, see Chapter 7.2.2. Continuous Recording.

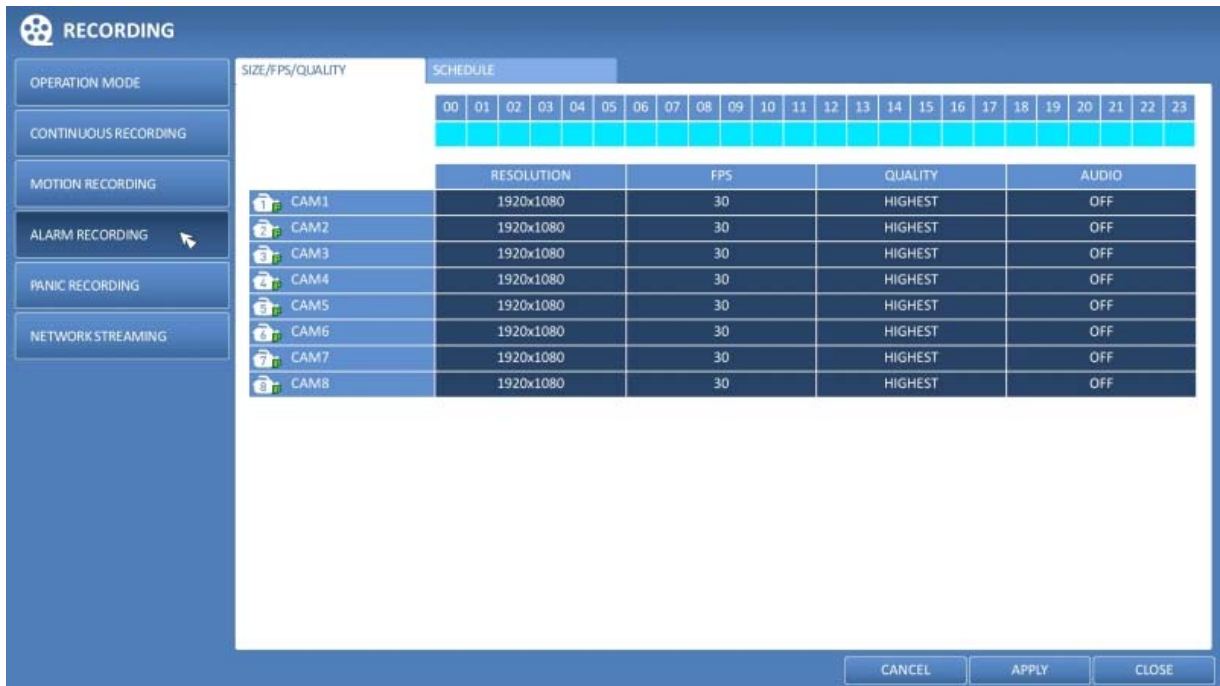

4. To apply the change, click on <APPLY> in the bottom of the screen.
5. When done, press the [EXIT] button on the remote control or click on <CLOSE> in the lower screen. The confirmation message will appear and you will return to the previous menu.

7.2.5. Panic Recording

In panic recording mode, you can specify the recording size and quality of the video.

1. From the <RECORD SETUP> menu, select <PANIC RECORD>.
2. Set each item of <RESOLUTION>, <FPS>, <QUALITY> and use of the <AUDIO> for the panic recording.

NOTE: For more information, see Chapter 7.2.2. Continuous Recording.



4. To apply the change, click on <APPLY> in the bottom of the screen.
5. When done, press the [EXIT] button on the remote control or click on <CLOSE> in the lower screen. The confirmation message will appear and you will return to the previous menu.

7.2.6. Network Streaming

You can specify the maximum size of the network streaming for remote users and set the FPS.

NOTE: Even if you set the resolution and FPS to high for the network streaming, the NVR will reduce the size or FPS according to the network status (speed) before transferring the recording video.

1. From the <RECORD SETUP> menu, select <NETWORK STREAMING>.
2. Use the [▲▼◀▶/ENTER] buttons on the remote control or use the mouse to select an item that you want to edit.
3. Set the <MAX RESOLUTION> and <MAX FPS> for each channel.
4. When done, click on <OK>.



4. To apply the change, click on <APPLY> in the bottom of the screen.
5. When done, press the [EXIT] button on the remote control or click on <CLOSE> in the lower screen. The confirmation message will appear and you will return to the previous menu.

8. Search

You can search for the recording data in the HDD by criteria like time, thumbnail, event, etc.

8.1. Moving To The Search Menu

8.1.1. Moving to the Search menu while in monitoring

> How to use the mouse :



> How to use the remote control (1) :



> How to use the remote control (2) :



8.1.2. Moving to the Search menu while in playback mode

> How to use the mouse :



> How to use the remote control :



8.2. Search Settings

8.2.1. Time Search

With the calendar, you can search for recording data by the recorded date.

1. From the <SEARCH> menu, select <TIME SEARCH>.
2. Use the [▲▼◀▶] buttons or use the mouse to specify the search date and time from the calendar in the left corner of the screen.

- > FIRST : The first date of recording is automatically selected.
- > LAST : The last date of recording is automatically selected.
- > 'Clock' Button : Press this to display the time selection menu where you can specify the time and date.

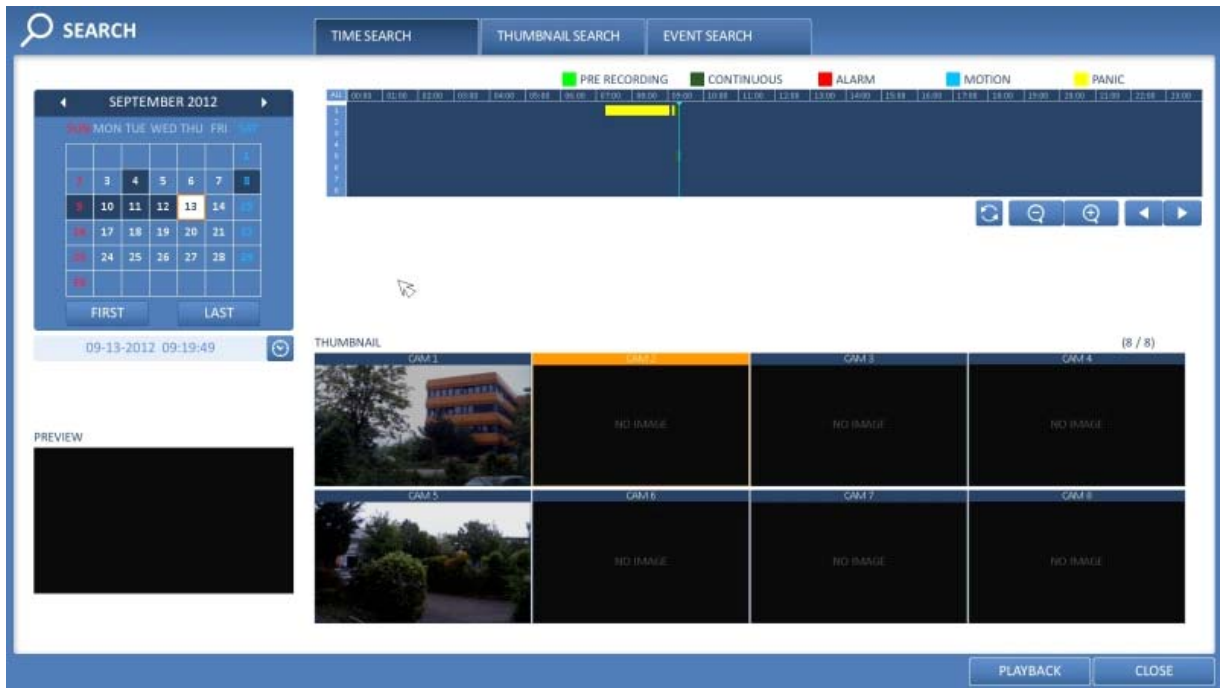

3. You can identify the type of the recording data by the colour in the bar.

- > Yellow Green (Pre-recording) : The pre-recording is performed on the recording data after you set the <PRE-RECORDING TIME> from <OPERATION MODE>.
- > Green (Continuous) : The continuous recording is performed on the recording data.
- > Red (Alarm) : The alarm event recording is performed on the recording data.
- > Blue (Motion) : The motion event recording is performed on the recording data.
- > Yellow (Panic) : The panic manual recording is performed on the recording data.

4. Click to move to a desired start time in the time bar, or use the buttons at the bottom of the status bar to search.

> 'Arrows in a Circle' Button: Update the timeline.

> 'Zoom out / REW' Button: Expand the timeline of the time bar to a greater unit of time.

> 'Zoom in/ FWD' Button: Collapse the timeline of the time bar to a smaller unit of time.

> 'Rewind Play' Button: Use this to move to a previous time that is hidden in the time bar as it is expanded to a greater time unit.

> 'Forward Play' Button: Use this to move to a next time that is hidden in the time bar as it is expanded to a greater time unit.

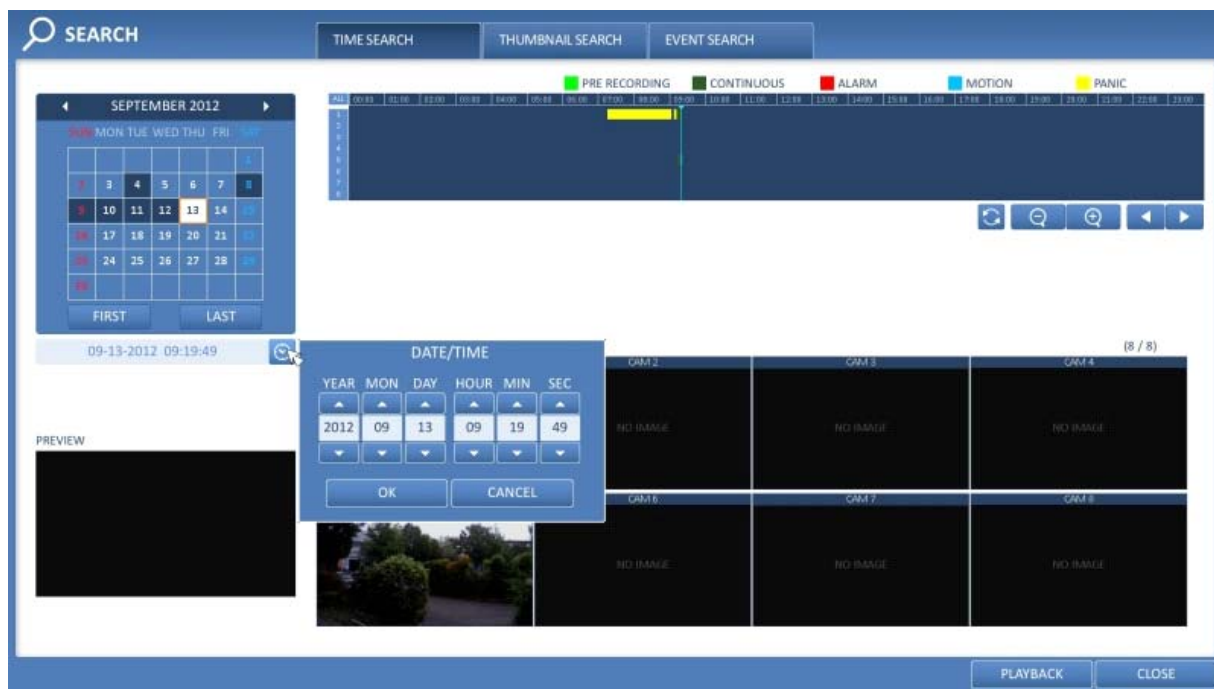

5. Click on a thumbnail channel or use the [▲▼◀▶] buttons on the remote control to move to a desired channel and press [ENTER]. You can check the video in <PREVIEW>.

NOTE: Click to move to a desired time, or simply double-click on a desired time in the time bar to play the video data of that time.

6. Press the [ENTER] button again on the remote control or simply double-click on the channel with the mouse, to move back to the playback screen.

7. If you want to stop the playback and return to the search screen, press [EXIT] or [SEARCH] on the remote control. You can also click on <MENU> in the lower left corner and select a desired menu.

8.2.2. Thumbnail Search

To improve your search, you will be provided with a range of thumbnails. Select Day, Hour or Minute to narrow down the search results.

1. From the <SEARCH> menu, select <THUMBNAIL SEARCH>.
2. Use the [▲▼◀▶] buttons or use the mouse to specify the search date and time from the calendar in the left corner of the thumbnail search screen.

- > FIRST : The first date of recording is automatically selected.
- > LAST : The last date of recording is automatically selected.
- > CHANNEL : Select a channel to search in.
- > DATE/TIME : Specify the search date and time.
- > INTERVAL : Specify the search date and time.

NOTE: The menus available differ depending on the selected interval mode.

- > INTERVAL: Select a time interval of the thumbnail view.

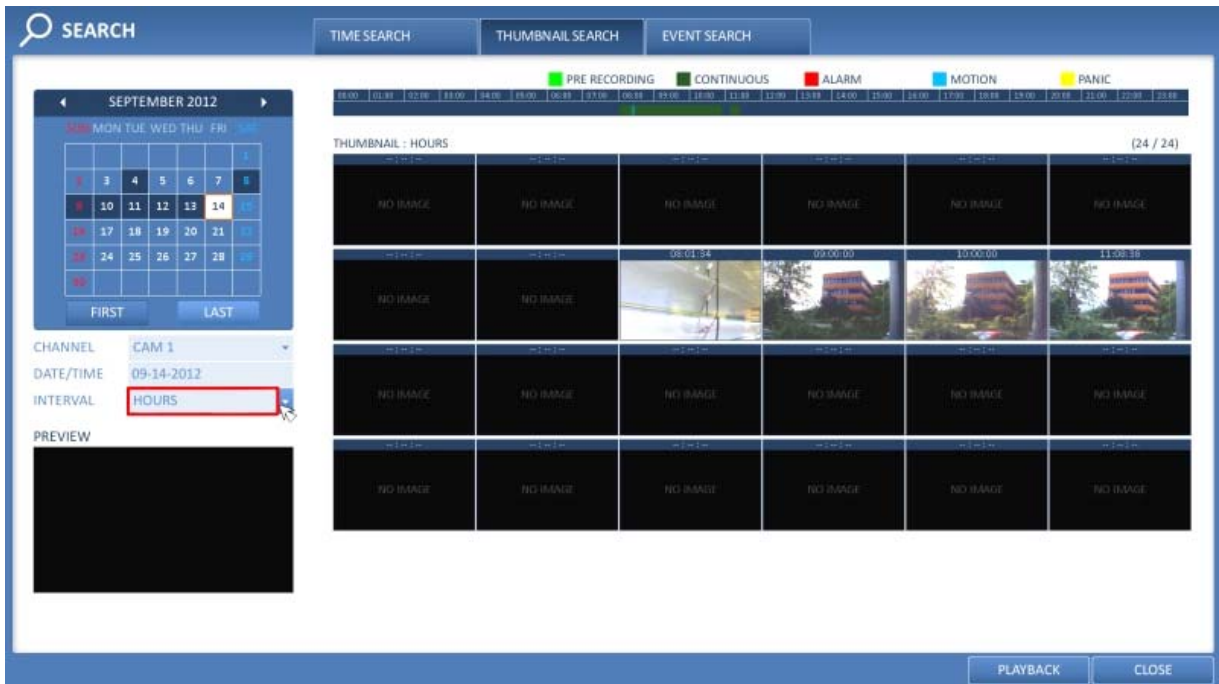
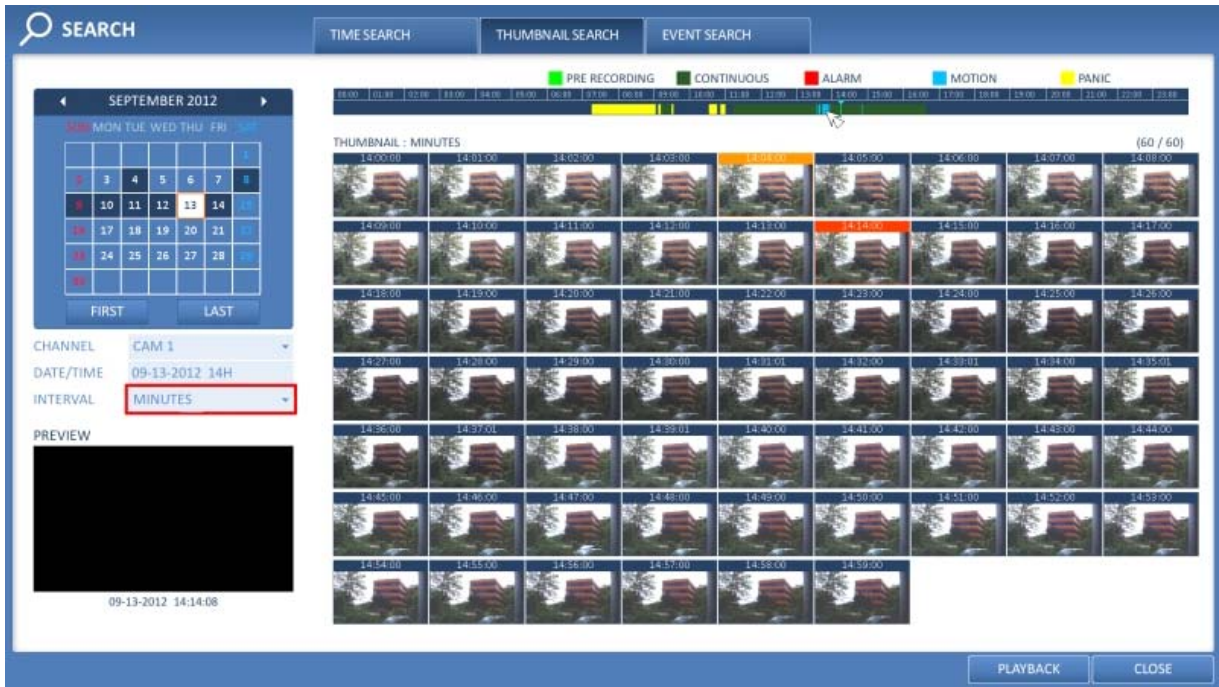

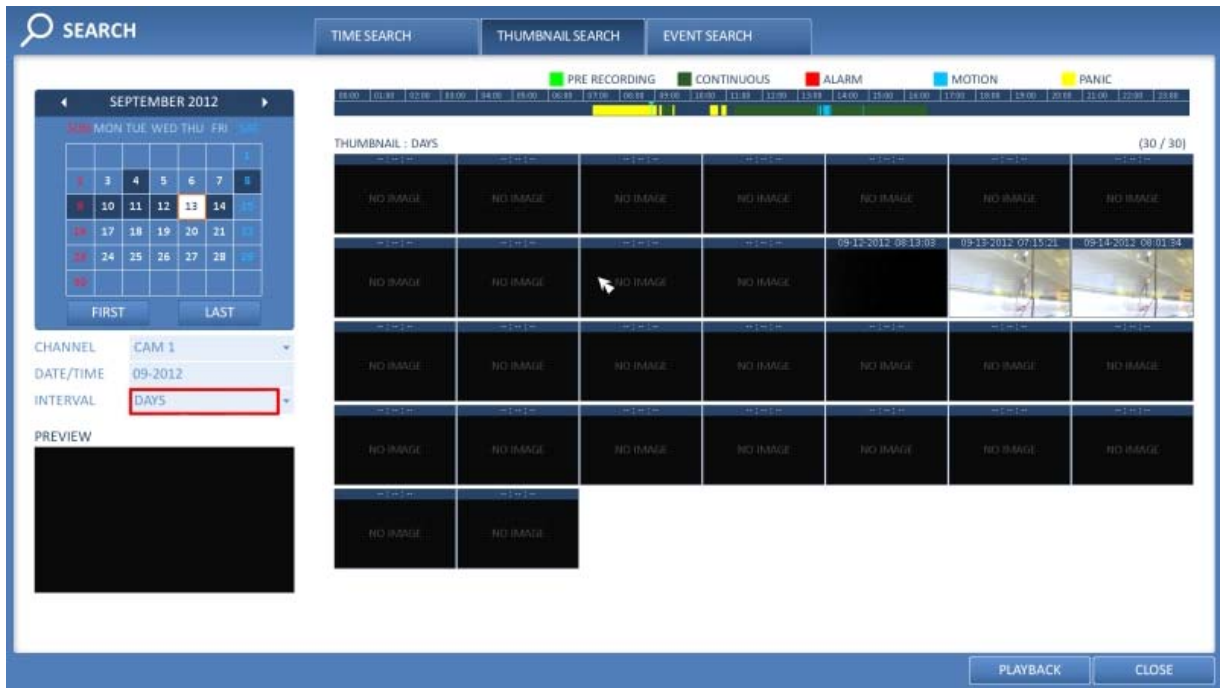

3. Double-click on a desired play time in the recording data bar, or double-click on a desired time image from the thumbnail list. You will move to the playback screen.
4. If you want to stop playing and return to the search screen, press [EXIT] or [SEARCH] on the remote control. You can also click on <MENU> in the lower left corner and select a desired menu.

8.2.3. Event Search

Search for events that occurred at a specified time and select an event to play from the list.

1. From the <SEARCH> menu, select <EVENT SEARCH>.
2. Use the [▲▼◀▶] buttons or use the mouse to specify the <START> and <END> times in the left of the event search list.
3. Select a channel to search.
4. Mark the checkbox of the event type to search for in the <EVENT> list.
5. Press the <SEARCH> button. The search results will be listed as shown in the picture below.

- > TYPE : Displays the event type.
- > TIME : Displays the recording start time.
- > CONTENTS : Shows the details of the event found.
- > ORDER BY : If you select <OLDEST>, the list will be sorted with the earliest one on top.

6. Double-click on a desired event or click on <PLAY> in the lower right corner to move to the play screen.
7. If you want to stop playing and return to the search screen, press [EXIT] or [SEARCH] on the remote control. You can also click on <MENU> in the lower left corner and select a desired menu.

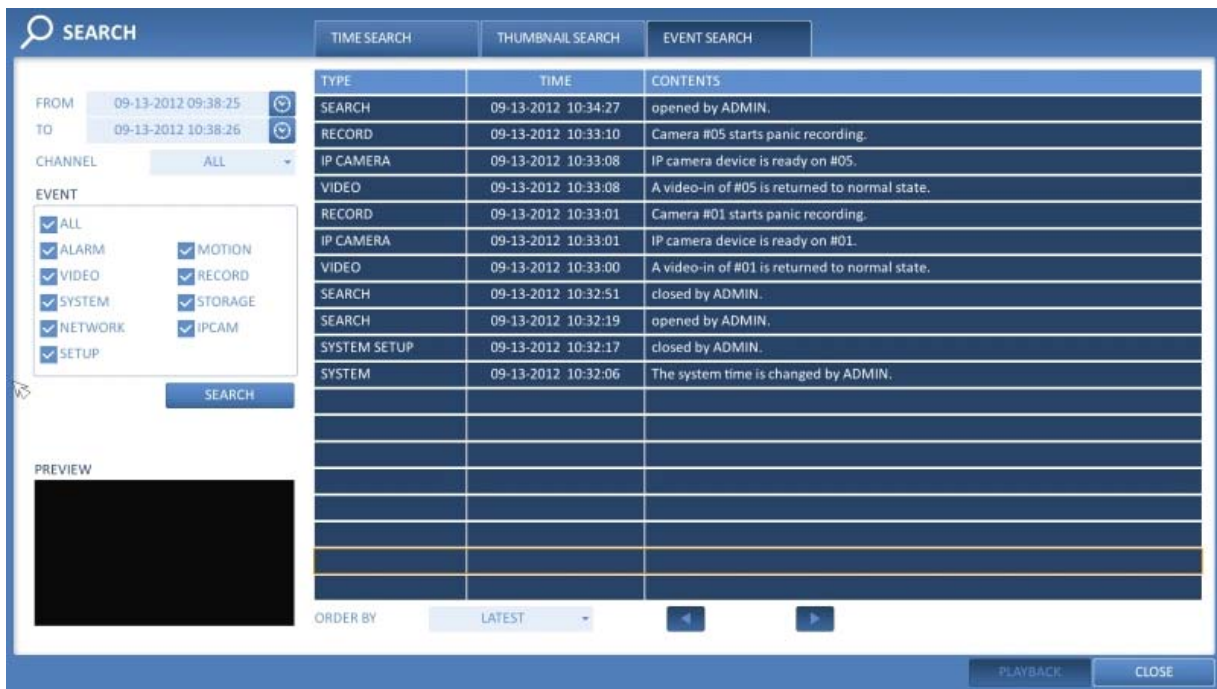

9. Playback

9.1. Using the Playback

1. To playback the searched data:
You can search for and playback a searched data.
2. To playback with the live viewer:
- Simply double-click on a desired time point in the right corner of the play screen.

NOTE: If you move the cursor to the rightmost, the "Timeline" bar will be displayed.

- Select a desired channel in the live screen and right-click on it to select <PLAY> in the context menu. Then, select a desired play time.

9.1.1. Playback Screen Configuration

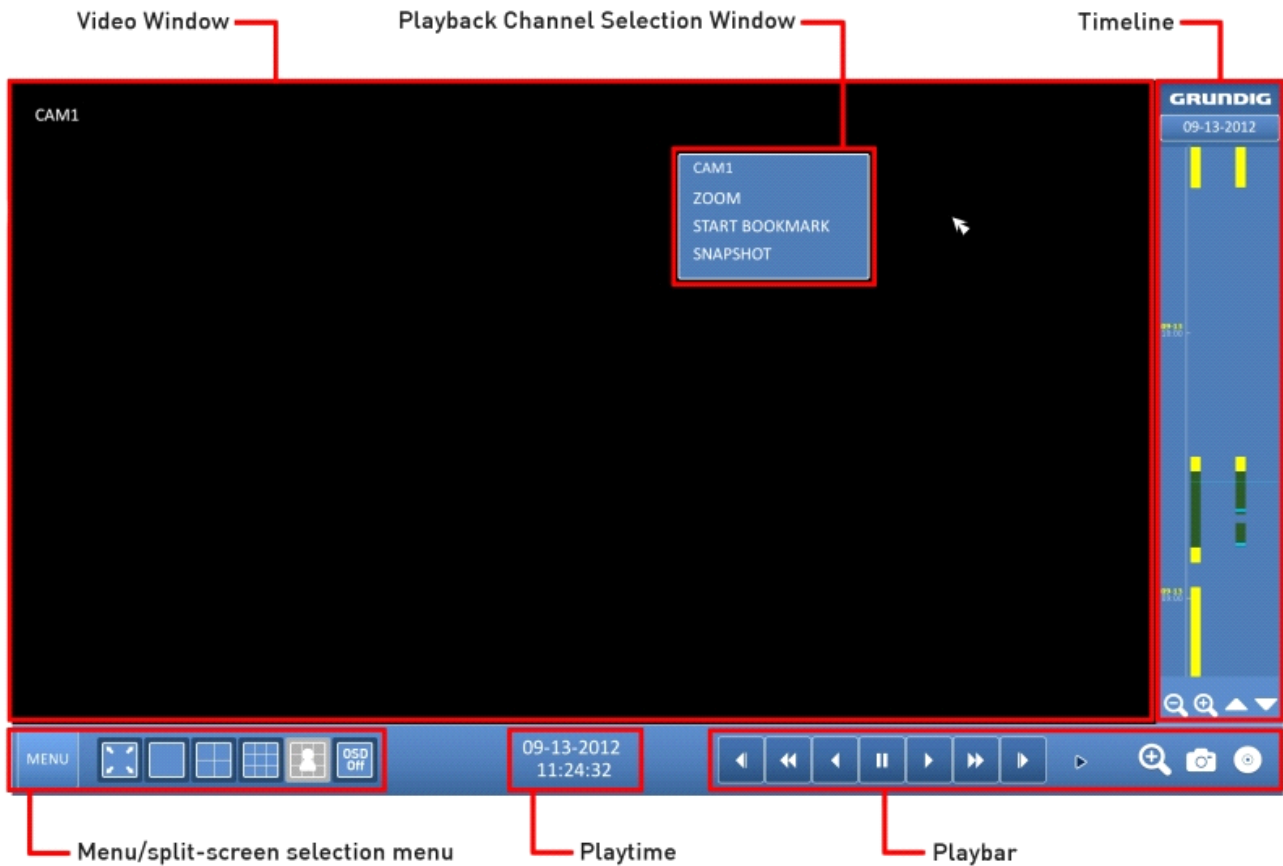

Video Window :
Displays the current video.

Timeline :
Displays the type of recording data. The vertical bar in the timeline indicates the current point of playback. Double-click on a desired point in the timeline to start playing the video from that point. You can also hold the left mouse button and drag it to select an area. Right-click on this marking, to perform a backup or an event search of this area.









Menu/Split-screen Selection Menu :
For more information about how to use each button, refer to Chapter 5.5.5. Using the status bar in the live mode.

Playback Bar :
You can start playing, stop playing or change the playback speed of the current video.

Playback Channel Selection Menu :

Item	Description
CAM1	Displays the title of the selected channel.
Zoom	Zooms in the video of the selected channel. (The zooming function is active only in '1' split screen.)
Start bookmarking	The "Set bookmark" pop-up appears, and you can bookmark a play point for the purpose of backup.
Snapshot Capture	Captures the current live video and saves it in .jpeg format.

Using the Playback Bar :

Item		Description
Jump		Move forward or backward.
Reverse Fast Play		The video will be reversely played at the speed of x64 > 32 > 16 > 8 > 4 > 2 in this order.
Reverse Play		Plays the video in the reverse direction.
Pause		Stop playing forward or playback temporarily.
Play		Play the video forward.
Fast Forward		The video will be played forward at the speed of x2 < 4 < 8 < 16 < 32 < 64 in this order.
Zoom In		Move to the zoom in/out screen of the selected channel.
Snapshot		Capture the current live video and save it in .jpeg format. Then, you can save the captured video on the HDD or export it to an external USB memory device. While you perform the snapshot, the current video will stop playing.
Start/end bookmark		Add a bookmark for the current playback screen. Press this to display the "SET BOOKMARK" window. Provide each entry and click on Start. The arrow in the bookmark button blinks to indicate that the bookmarking is in process. If you press the Bookmark button again, the bookmarking stops and the current settings will be reserved. Then, the reserved data can be backed up in the Archive menu or can be played in the "RESERVED DATA MANAGEMENT" menu.

Bookmarking :

During playback, you can add a bookmark for reserving the video data. You can view the bookmarked data in the Archive menu, which can be saved to a connected device for backup purpose.



1. Provide a tag in the <TAG> item for data reservation.
2. Provide the details of the reserved data in the <MEMO> input box.
3. Click on <START>. You will return to the play screen with the backup progress.
4. To stop the bookmarking, click on <BOOKMARK('CD Icon')>.
5. To quit the bookmarking, click on <STOP>. To continue with bookmarking, just click on <CONTINUE>.

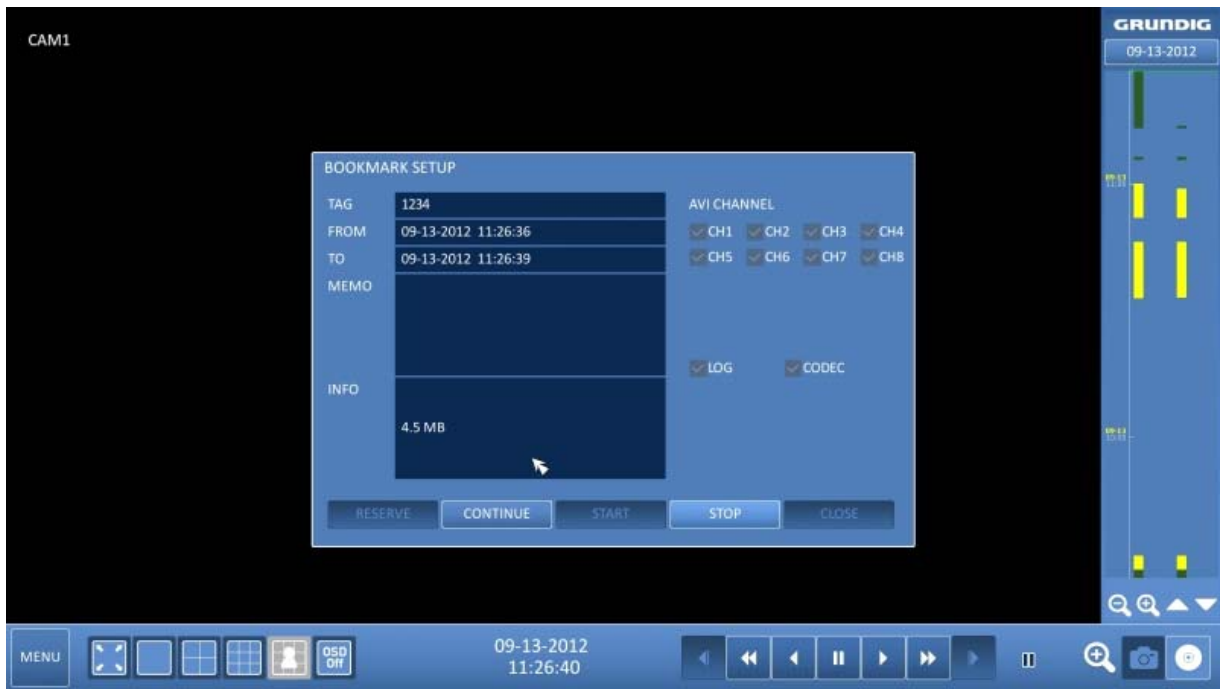

6. Click on <RESERVE>. You can export the reserved data to a connected storage device using the <ARCHIVE> menu.

What is the <RESERVE> function?

With the <RESERVE> function, you can reserve data even in overwrite mode. This is useful if you want to backup data but you have no backup device available such as a USB memory. If you use "Reserve", the recording days will be compromised. When you have backed up the reserved data to an external device, it is recommended to delete the internal reserved data.

10. Archiving

10.1. Starting the Archive Menu

Using the Archive menu during monitoring :

1. Click on the <MENU> button in the lower left corner and select the <ARCHIVE> menu.
2. Press the [ARCHIVE] button on the remote control.

10.1.1. Archive

You can archive the searched data or reserve it.

1. From the <ARCHIVE> menu, select <ARCHIVE>.
2. Select a date for the archive from the calendar in the left.

NOTE: The date containing recording data will be marked in a colored box.

- FIRST : The first date of the recording is automatically selected.
- LAST : The last date of the recording is automatically selected.

3. Check the <START> and <END> times. Drag the timeline to specify the start and end time.
4. Mark the <LOG> and <CODEC> checkboxes to select and include them in the archiving.

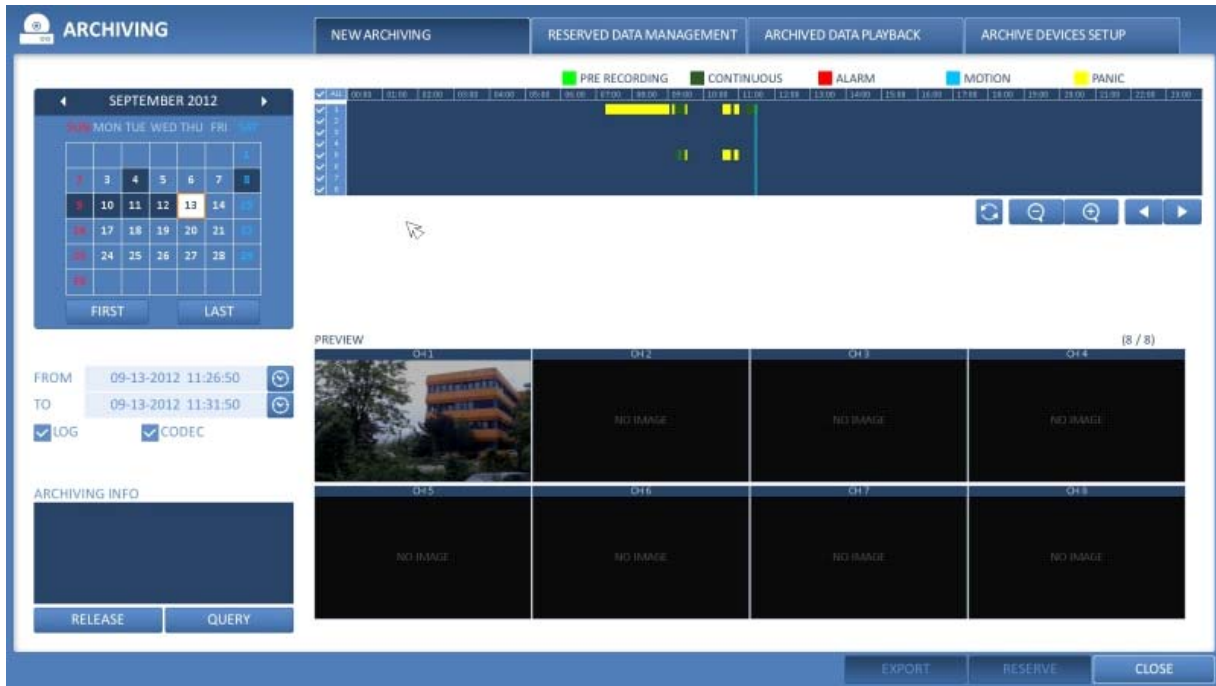

5. Click on <QUERY>. The results will be listed in <ARCHIVING INFO>.

NOTE: The maximum backup capacity for one time is 20GB. If the archiving request exceeds 20GB, the end time will be adjusted to up to 20GB.

6. If you want to import data to a storage device, connect it to the NVR and click <EXPORT>.
7. If you just want to reserve the data, click <RESERVE>. If the <TAG NAME> dialog appears, enter the name and click on <OK>. Click <RESERVE> to save it to the HDD.

NOTE: Using <RESERVE> will compromise the recording days available. When you have archived the reserved data to an external device, it is recommended to delete the internal reserved data.

8. To exit the Archive menu, click on <CLOSE>.

10.1.2. Reserved Data Management

You can search for the reserved data and delete or import it to a storage device.

1. From the <ARCHIVE> menu, select <RESERVED DATA MANAGEMENT>. The reserved data will be listed.
2. Select a data type from <AVI> and <Snapshot Capture>.
 - > AVI : Searches AVI video files stored in the DVR.
 - > SNAPSHOT CAPTURE : Searches the captured snapshots stored in the DVR.
3. If you want to play the data, double-click on a desired data item or click on it and select <PLAY>.
4. If you want to export to a storage device, connect it to the NVR and click <EXPORT>.
5. If you want to delete the reserved data, click on <X> next to the list. Click on <CANCEL ALL> to cancel the whole page at once.
6. To exit the Archive menu, click on <CLOSE>.

NAME	START	END	SIZE	SET BY	
fhtg	08-22-2012 10:43:01	08-22-2012 10:48:01	410.5 MB	ADMIN	X
201208221148~201208221149	08-22-2012 10:48:18	08-22-2012 10:49:45	131.0 MB	man	X
ak	09-04-2012 13:15:12	09-04-2012 13:15:59	38.9 MB	ADMIN	X
123	09-13-2012 11:26:05	09-13-2012 11:26:37	12.1 MB	ADMIN	X

10.1.3. Playing the Archived Data

You can search the storage device for the archived data and check the details of it or play it.

1. Connect the storage device containing the archived data.
2. When the storage device is recognised, click on <SEARCH>.

NAME	SIZE	SET BY	START	END	

3. To view the details, click on the 'Document' button next to the list. Click on <VERIFY INTEGRITY> to check if the data is corrupt or incomplete.
4. Select an item to play from the list and click <PLAY>.
5. To exit the Archive menu, click on <CLOSE>.



10.1.4. Archive Devices Setup

Provide the FTP server information for archiving data on the HDD before testing the transfer.

1. From the <ARCHIVE> menu, select <ARCHIVE DEVICES SETUP>.
2. Move to the FTP information box.
3. Fill in each item using a virtual keyboard.

- > HOST NAME : Enter the address at which you can access the server.
- > PORT : Enter the port number to which you can access the server.
- > USER NAME : Enter the user ID with which you can access the server.
- > PASSWORD : Enter the connection password.
- > DIRECTORY : Specify the archiving path.

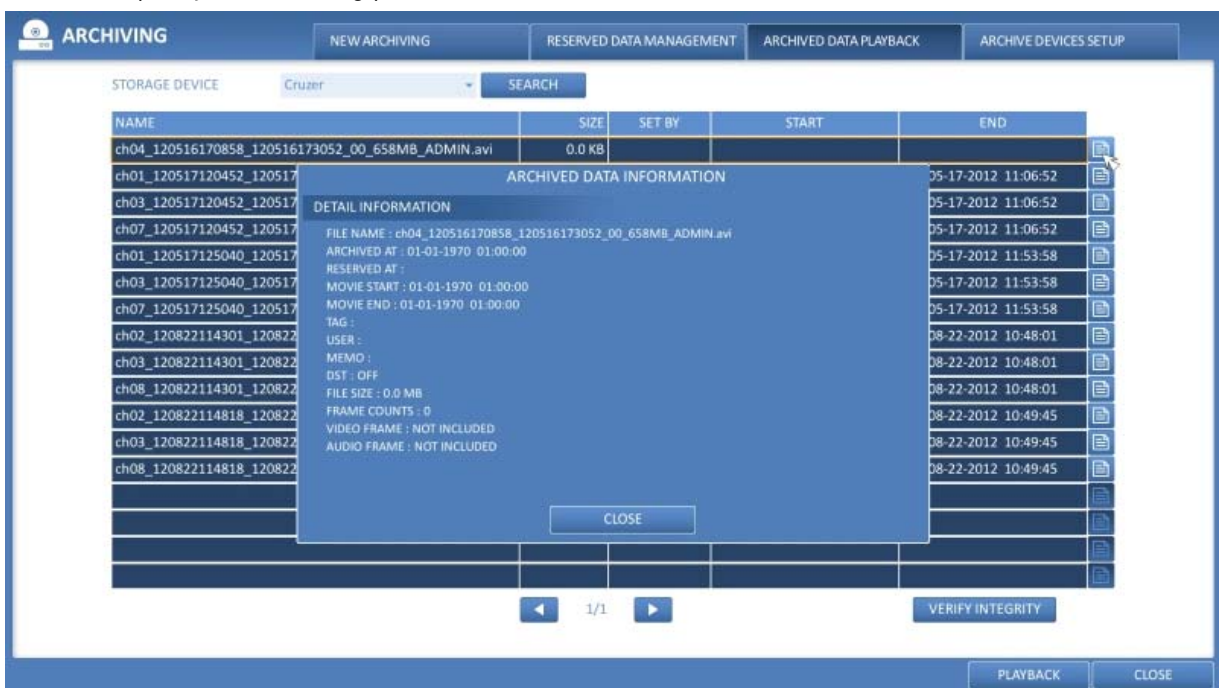

-
4. When all information is filled in, click on <CONNECTION TEST> to check the connection status.
 5. To apply the change, click on <APPLY> in the bottom of the screen.
 6. When done, press the [EXIT] button on the remote control or click on <CLOSE> in the lower screen. The confirmation message will appear and you will return to the previous menu.

11. Web Remote Viewer

11.1. What is the Web Remote Viewer?

Web Remote Viewer is an application software program for a PC (for web browser) that provides a user-friendly interface for easier access and use over the network, to access the NVR remotely, to view or search live / recorded videos and to control NVR.

11.1.1. System Requirements

The following is the minimum hardware and operating system requirements to run the Web Remote Viewer.

Operating System :

Windows XP Professional, Windows Vista Home Basic / Premium, Windows 7

Web Browsers :

Internet Explorer 7.0 or later / Mozilla Firefox 3.6 / Google Chrome 4.1 / Opera 10

(Some web browsers other than Internet Explorer may not fully function.)

CPU : Intel Pentium 2.0 GHz

Memory : 512 MB

Display : 16-bit 1024 x 768 High Color

Hard Disk Drive :

50MB (space required for installing the web viewer)

*Additional HDD space is required for saving your recordings. The file size of your recording may differ depending on the specified quality.

11.1.2. Connection

Open a browser and enter the IP address of the NVR, or type the URL in the address bar.

How to connect to the NVR from the inside :

- Check the "Network Status" and verify the <IP ADDRESS> and <WEB SERVICE PORT> of the NVR (Chapter 6.6.4. Network Status).
- Enter the IP address and web service port in the address bar of the browser. Ex.:<http://192.168.1.200:8080>

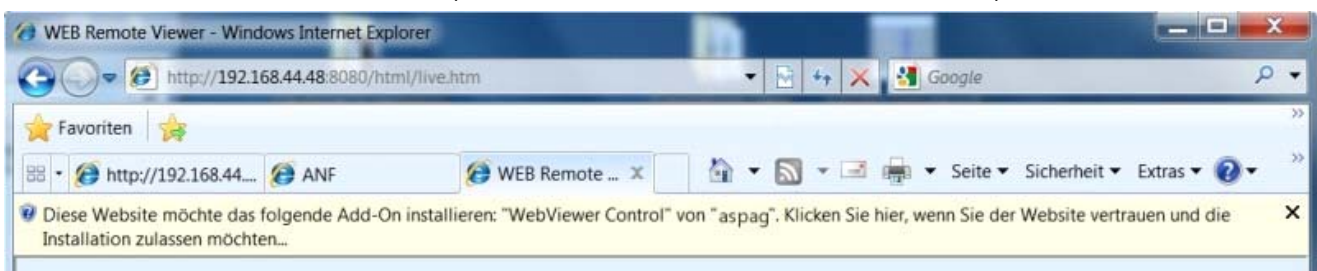

How to connect to the NVR from the outside :

> Using the IP address

- Check the "Network Status" and verify the <EXTERNAL IP ADDRESS> and <WEB SERVICE PORT> of the NVR (Chapter 6.6.4. Network Status).
- If using a fixed (external) IP, enter the external IP that is specified in the NVR in the address bar of the web browser. Ex.: If the internal IP address is set to "<http://222.112.4.48:8080>" (192.xxx.xxx.xxx), no access from outside is allowed.

> Using the URL

- Check the "Network Status" and verify the <DDNS ADDRESS> and <WEB SERVICE PORT> of the NVR (Chapter 6.6.4. Network Status).

- Enter the DDNS address and web service port in the address bar of the browser. Ex.:
http://00115f123456.DVRLINK.NET:8080

NOTE: In a router network, you have to set the "Port Forwarding" and "DMZ Setting" to allow access from outside. For the necessary settings of the router, please refer to the user manual of the router or contact the manufacturer of the router

1. Provide the user ID and password.

NOTE: The default User name is: ADMIN. The default password (P) is: 1234.

2. Click the upper warning bar to install the ActiveX.

NOTE: If you fail to download the ActiveX control, move to Tools > Internet Options > Security > Custom Level > Download unsigned ActiveX control, and change its setting from "Disable (recommended)" to "Enable", and then click OK.

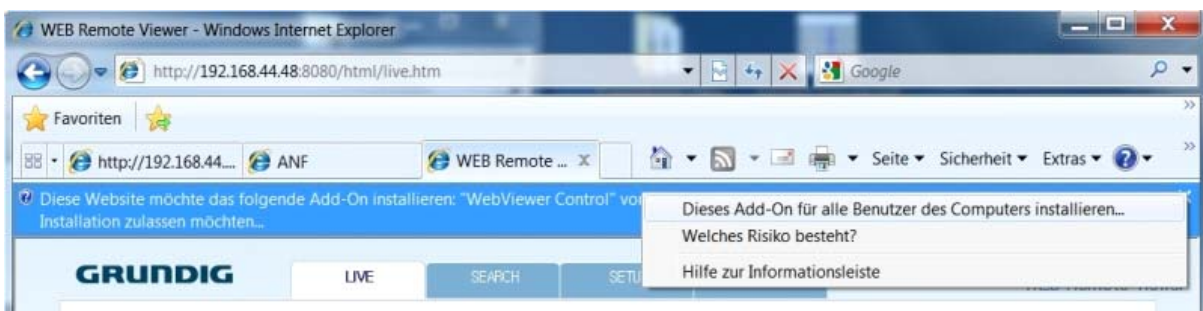

3. Click on <Install> in the appearing window.

4. When the installation is complete, you will see the live screen.



11.2. Live

11.2.1. Live Screen At a Glance

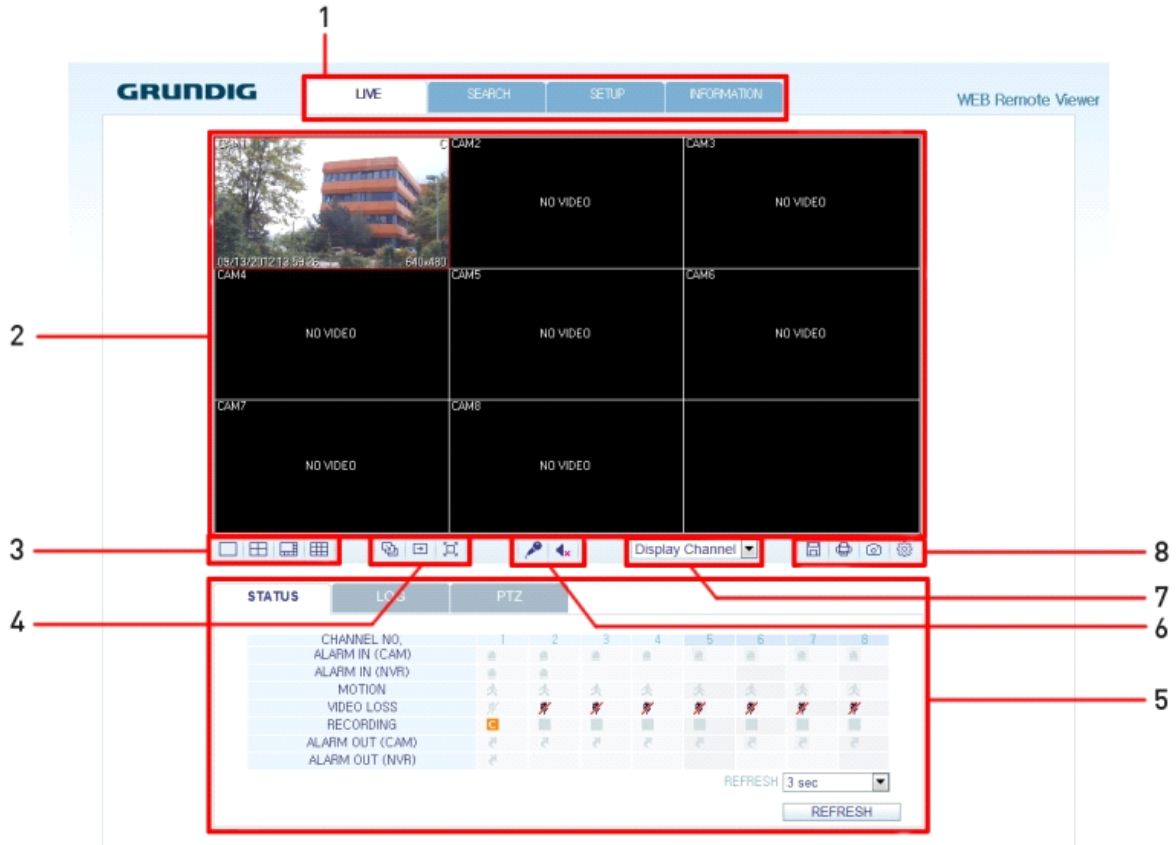

No.	Item	Description
1	View selection tab	You can switch to the live, playback and setup screen and check the provided information.
2	Live	Displays the live screen of the currently connected NVR.
3	Split Mode	Select and switch to a desired split-screen mode.
4	Sequence	Set the sequence mode, switch to the next camera or select the full screen mode.
5	Status	Shows the connection status of each channel.
	Log	Shows the log.
	Refresh Time	Sets the interval at which the NVR Status is refreshed.
	Reload	Loads the NVR Status immediately.
6	Voice transmission	With the microphone, your voice will be transmitted to the NVR, or you can turn on or off the output of the voice signal.
7	Channel	Select a channel listed in the screen.
8	Save	Save the live video on the screen.
	Print	Print out the current screen.
	Capture	Capture the selected image.
	ActiveX Settings	Configure the ActiveX settings or specify the saving path of the captured image.

11.2.2. Switching the split mode

Click on the 'Switch' button to switch the mode as follows:





11.2.3. Saving the video

1. Click on the 'Disk symbol' button to start saving.
2. The video from the selected channel will be saved to the PC in the AVI format (Default path: C:\SaveFolder). Click on the 'Disk symbol' button again to stop saving. Click on <ActiveX Setting> to display the context menu to see where you can change the saving path.

11.2.4. Printing

1. Click on the 'Printer symbol' button.
2. The current screen will be printed with the printer connected to the PC.

11.2.5. Screen Capture

1. Click on the 'Camera symbol' button.
2. The current screen of the selected channel will be saved to the path specified in the PC (Default path: C:\SaveFolder). Click on <ActiveX Setting> to display the context menu where you can change the saving path.

11.2.6. ActiveX Settings

1. Click on the 'Rhombus' button in the right corner at the bottom of the screen.
2. When the setup screen appears, you can change the settings of the render type, audio, capture and saving path as well as the video streaming.
 - > Render : DirectDraw is recommended in order to enable the hardware acceleration.
3. If you want to change the saving path, click <...> (Save Folder) and specify a new path. The Windows Vista user cannot change the saving path.
4. Change the streaming settings according to the PC specification and network environment. Auto mode is recommended.

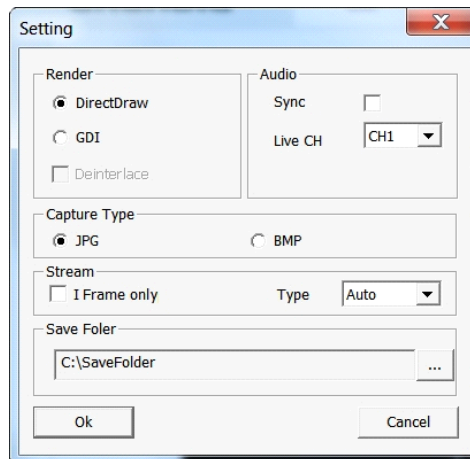

- > Sync : If this option is set, the audio signal will be synchronised with the video signal. However, you may encounter a delay due to buffering for the synchronisation.
- > Live CH : Set the audio signal to use in live monitoring mode.
- > I Frame Only : Only the I frames (key frames) will be transferred.
- > Type :
 - Auto : The DVR will optimise the quality and FPS to the network status and the specification of the connected PC before transferring the data.
 - Main : The video will be transferred in high definition (HD).
 - Second : The video will be transferred in a medium definition (SD).

5. When done, click <OK> to save your settings.

11.2.7. Status tab

Click on <Status> at the bottom of the screen. You can check the event occurrence for each channel of the connected NVR.

STATUS	LOG	PTZ						
CHANNEL NO.	1	2	3	4	5	6	7	8
ALARM IN (CAM)	🔒	🔒	🔒	🔒	🔒	🔒	🔒	🔒
ALARM IN (NVR)	🔒	🔒	🔒	🔒	🔒	🔒	🔒	🔒
MOTION	🔒	🔒	🔒	🔒	🔒	🔒	🔒	🔒
VIDEO LOSS	🔒	🔒	🔒	🔒	🔒	🔒	🔒	🔒
RECORDING	🔒	🔒	🔒	🔒	🔒	🔒	🔒	🔒
ALARM OUT (CAM)	🔒	🔒	🔒	🔒	🔒	🔒	🔒	🔒
ALARM OUT (NVR)	🔒	🔒	🔒	🔒	🔒	🔒	🔒	🔒

REFRESH 3 sec

REFRESH

11.2.8. Log tab

Click on <Log> at the bottom of the screen. You can check the log of the connected NVR.

No.	CAMERA TITLE	DATE TIME	LOG
1		2012.09.13 13:59:24	LIVE: ADMIN log on from 192.168.44.73.
2		2012.09.13 13:57:34	LIVE: ADMIN log on from 192.168.44.73.
3	CAM1	2012.09.13 13:57:14	RECORD: Camera #01 starts continuous recording.
4	CAM1	2012.09.13 13:57:14	MOTION: A motion event of #01 is returned to normal state.
5	CAM1	2012.09.13 13:57:14	RECORD: Camera #01 stops motion recording.
6		2012.09.13 13:56:52	LIVE: ADMIN log on from 192.168.44.73.
7	CAM1	2012.09.13 13:56:42	MOTION: A motion event is detected on #01.
8	CAM1	2012.09.13 13:56:42	RECORD: Camera #01 starts motion recording.

PAGE DOWN PAGE UP

REFRESH 3 sec

REFRESH

11.2.9. Status tab

Click on <PTZ> at the bottom of the screen. You can control the operations of a PTZ camera. Adjust the focus, zooming and iris of the camera. You can use the arrow buttons to control the operations of the camera.

- > Pattern / Cruise : You can configure various settings of the camera including zooming and movement (applies to some PTZ cameras only).
- > PRESET : Move the camera in a predefined direction and zoom setting.
- > Swing / Auto Pan : The camera will move back and forth between two preset positions.

Pattern

0

Set Run

PRESET

0

Set Run

Swing

START 0

END 0

Run

STEP 1

ZOOM + -

FOCUS + -

IRIS + -

PTZ

11.3. Search

Click on <Playback> to display the remote control screen for the NVR.

11.3.1. Search Viewer At a Glance

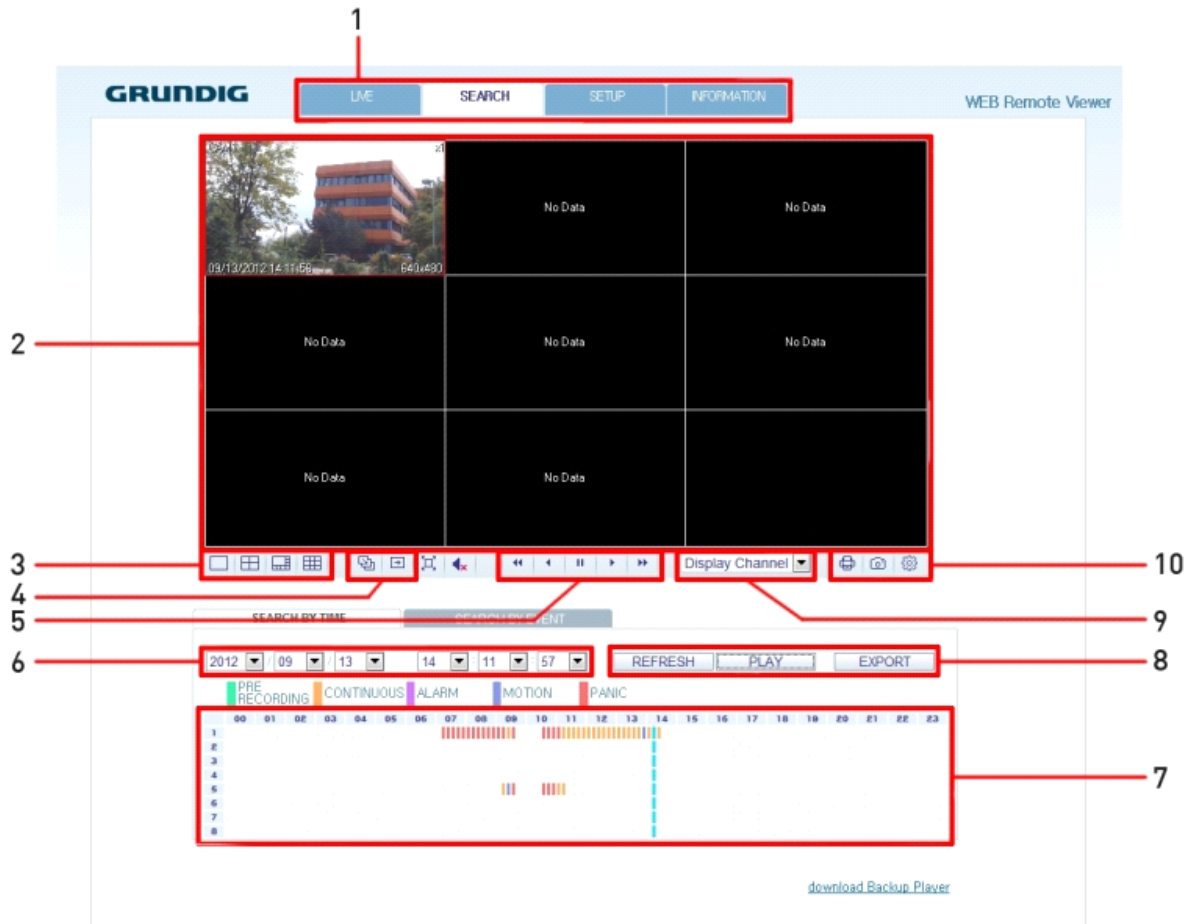

No.	Item	Description
1	View selection tab	You can switch to the live, playback and setup screen and check the provided information.
2	Playback Screen	Play the recording data.
3	Split Mode	Select and switch to a desired split-screen mode.
4	Sequence	Set the sequence mode, switch to the next camera or select the full screen mode. You can turn on/off the voice signal.
5	Play button bar	You can control the playback screen.
6	Time Selection	Specify the start time of playback.
7	Time Line	Indicates the status of the recorded data.
8	REFRESH	Reload the time line.
	PLAY	Play the video that satisfies your search criteria.
	Backup	Archive the video that satisfies your search criteria.
9	Channel Selection	Select a channel listed in the screen.
10	Screen	Print out the current screen.
	Image Capture	Capture the selected image.
	ActiveX Settings	Configure the ActiveX settings or specify the saving path of the captured image.

11.3.2. Search by time

Use the timeline to search for the data recorded in the NVR.



1. Select a date that you want to search for.
2. Click on <REFRESH>.
3. Check the existence of recording data in the bottom time line and specify the time range for your search. You can specify the start time by moving the time bar.
4. Click on <PLAY>.

> REFRESH : If your changes are not applied to the current screen, reload the changes.

> PLAY : Play the searched video.

> Backup : Archive the recorded video.

11.3.3. Search by event

You can sort the recording data items by event to facilitate your search.

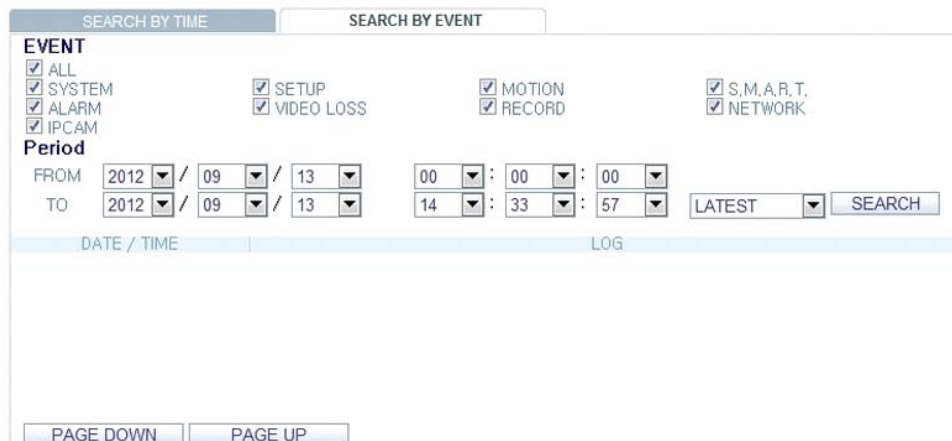

1. Mark the checkbox of the event that you want to search for.
2. Specify the start and end dates and times for your log search.
3. Set the display order of the items found.

> LATEST : The most recent event will be listed on top.

> OLDEST : The earliest event will be listed on top.

4. Click on <SEARCH>. You can check the log for your search at the bottom of the screen.

5. Select a log to play the recording data.

11.4. Setup

Click on <SETUP> to display the remote control screen for the NVR. When done, click on <OK> to apply the changes to the remotely connected NVR.

NOTE: If the NVR is in process of system or record setting, the remote control will be disabled.

ATTENTION: If you change the settings remotely at will, the major 'Record Settings' of the NVR may be changed, which is not recommended at all.

11.4.1. Setup Viewer At a Glance



The screenshot shows the Grundig WEB Remote Viewer interface. At the top, there are tabs for LIVE, SEARCH, SETUP, and INFORMATION. The SETUP tab is active. On the left, a navigation menu lists various settings categories: CAMERA, CAMERA TITLE, CAMERA SETUP, COVERT SETUP, MOTION SENSOR, PTZ SETUP, DISPLAY, AUDIO, USER, NETWORK, SYSTEM, STORAGE, EVENT, and RECORD. The main area is titled 'CAMERA TITLE' and contains a table with two columns: 'CHANNEL' and 'CAMERA TITLE'. The table lists channels 1 through 8, each with a corresponding camera title (CAM1 to CAM8). There are 'APPLY' and 'CANCEL' buttons at the bottom right of the table.

CHANNEL	CAMERA TITLE
ALL	
1	CAM1
2	CAM2
3	CAM3
4	CAM4
5	CAM5
6	CAM6
7	CAM7
8	CAM8

11.4.2. Camera

Giving a camera a title :

You can name the camera title that is displayed on each channel screen. Select a channel to name and provide a new title. Then, click on <OK> to apply it.

NOTE: You can enter up to 9 alphanumeric characters for the camera title.

CAMERA TITLE

CHANNEL	CAMERA TITLE
ALL	
1	CAM1
2	CAM2
3	CAM3
4	CAM4
5	CAM5
6	CAM6
7	CAM7
8	CAM8

APPLY CANCEL

Image Setting :

Adjust the brightness, contrast and more of each camera. When done, click <OK> to apply the changes.

NOTE: The default colour value is <50> (Brightness, Contrast, Tint, Color). If you change the default settings, the video from the NVR or the video colour may not be displayed properly.

The screenshot shows the Grundig camera setup interface. The main menu on the left includes options like CAMERA, DISPLAY, AUDIO, USER, NETWORK, SYSTEM, STORAGE, EVENT, and RECORD. The 'CAMERA SETUP' section is expanded. The 'CAMERA IMAGE SETUP' page is displayed for 'CH1 - CAM1' (GCH-K1603B). The 'IMAGE SETTINGS' tab is selected, showing a live video feed of a building. The 'IMAGE PROFILE' section has sliders for BRIGHTNESS (79), CONTRAST (37), HUE, COLOR (47), and SHARPNESS (56). Other sections include FOCUS (AUTO FOCUS, DEFAULT SPEED, NEAR LIMIT, FAR LIMIT), WHITE BALANCE (AUTO), WIDE DYNAMIC RANGE (OFF), and DAY / NIGHT (IR CUT FILTER). Buttons for 'COPY SETTING TO', 'APPLY', and 'CANCEL' are visible.

Exposure:

Adjust the exposure related settings of the camera. For further information, please read the chapter Exposure Setup under the Camera Setting of the NVR.

The screenshot shows the Grundig camera setup interface. The main menu on the left includes options like CAMERA, DISPLAY, AUDIO, USER, NETWORK, SYSTEM, STORAGE, EVENT, and RECORD. The 'CAMERA SETUP' section is expanded. The 'CAMERA IMAGE SETUP' page is displayed for 'CH1 - CAM1' (GCH-K1603B). The 'EXPOSURE' tab is selected, showing a live video feed of a building. The 'EXPOSURE TIME' section has sliders for MIN EXPOSURE TIME and MAX EXPOSURE TIME. The 'GAIN' section has sliders for MIN GAIN and MAX GAIN. The 'IRIS' section has sliders for MAX IRIS and MIN IRIS. The 'MODE' is set to 'AUTO' and 'BLC CONTROL' is 'OFF'. Buttons for 'COPY SETTING TO', 'APPLY', and 'CANCEL' are visible.

Covert Setting :

You can set to hide the video of a specific camera from a specific user. Set to hide the camera video so that a specific user or user group cannot view it. To change the covert settings from user group to user, move to the <USER> menu and make necessary changes. When done, click on <OK> to apply the changes.



Motion Sensor :

Enable or disable motion detection for each camera. Define the area and the sensitivity which are used for motion detection.

Activation :

Turn the motion detection On or Off for each camera and activate the Onscreen notification.

Area :

Specify the use of motion detection and reaction for each channel and set also the daytime/nighttime options. Select a channel. Set the mask area and activation and specify the daytime range. When done, click on <OK> to apply the changes.

NOTE: For information on how to set the motion area, please refer to "Motion Area Setup" (in Chapter 6.2.4. Motion Sensor).

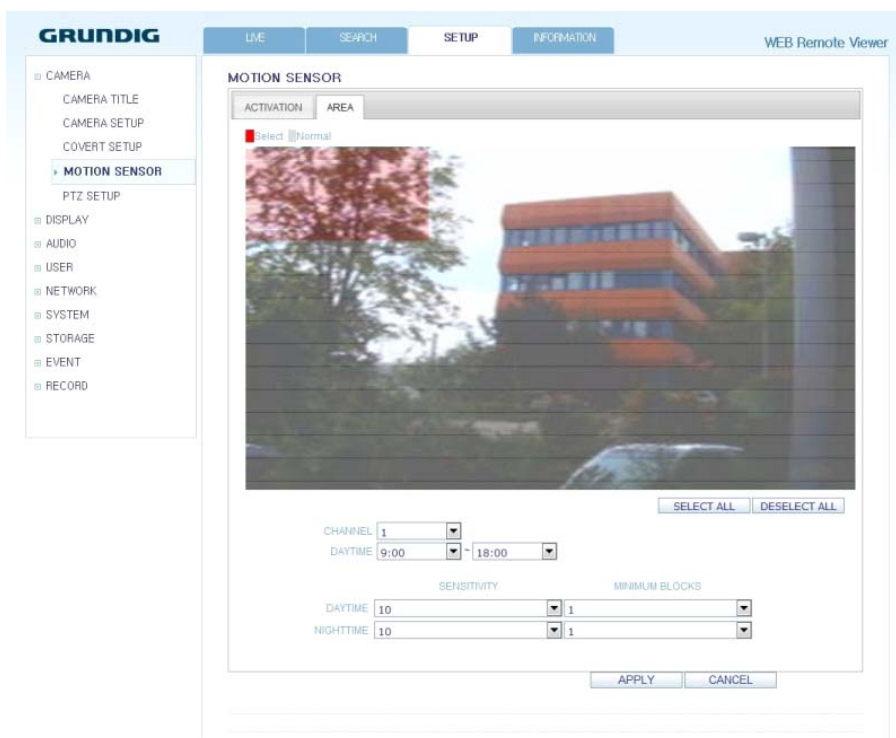

PTZ Setup:

If you have a camera connected via a serial connection you can adjust the settings for the PTZ camera here. Select the camera and adjust the used address number, protocol and baudrate of the camera. Activate the RS485 button, if the camera id connected over the RS485 connection.

CHANNEL	ADDRESS	PROTOCOL	BAUD RATE	RS485
1	0	PELCO-D	9600	<input type="checkbox"/>
2	0	PELCO-D	9600	<input type="checkbox"/>
3	0	PELCO-D	9600	<input type="checkbox"/>
4	0	PELCO-D	9600	<input type="checkbox"/>
5	0	PELCO-D	9600	<input type="checkbox"/>
6	0	PELCO-D	9600	<input type="checkbox"/>
7	0	PELCO-D	9600	<input type="checkbox"/>
8	0	PELCO-D	9600	<input type="checkbox"/>

11.4.3. Display

OSD Setting :

Configure the settings for the time, title, boundary, icon and language that will be displayed on the screen. Make changes to each item of the OSD menu and click on <OK> to apply the changes.

NOTE: For details about each displayed item, please refer to Chapter 6.3.1. OSD.

CAMERA TITLE	On
RECORDING MODE ICON	On
AUDIO ICON	On
STATUS BAR ON FULL SCREEN MODE	Auto Hide
TIMELINE ON FULL SCREEN MODE	Auto Hide
BORDER	On
BORDER COLOR	Gray
LANGUAGE	ENGLISH

Monitor Settings :

You can set the interval of an active sequence. Specify the interval and click on <OK> to apply it.

The screenshot shows the Grundig WEB Remote Viewer interface. At the top, there are tabs for 'LIVE', 'SEARCH', 'SETUP', and 'INFORMATION'. The 'SETUP' tab is active. On the left, a sidebar menu lists various settings categories: CAMERA, DISPLAY, OSD, MONITOR (highlighted), AUDIO, USER, NETWORK, SYSTEM, STORAGE, EVENT, and RECORD. The main content area is titled 'MONITOR' and contains a 'SEQUENCE DWELL' dropdown menu set to '5 Sec'. Below the menu are 'APPLY' and 'CANCEL' buttons.

11.4.4. Audio

Audio/Buzzer :

You can configure the settings of the voice and audio signal.

NOTE: For details about each displayed item, please refer to Chapter 6.4. Audio Setup.

The screenshot shows the Grundig WEB Remote Viewer interface. At the top, there are tabs for 'LIVE', 'SEARCH', 'SETUP', and 'INFORMATION'. The 'SETUP' tab is active. On the left, a sidebar menu lists various settings categories: CAMERA, DISPLAY, AUDIO (highlighted), AUDIO BUZZER SETUP (highlighted), USER, NETWORK, SYSTEM, STORAGE, EVENT, and RECORD. The main content area is titled 'AUDIO' and 'BUZZER'. Under 'AUDIO', there are three dropdown menus: 'DEFAULT LIVE AUDIO CHANNEL' set to 'Off', 'NETWORK AUDIO TRANSMISSION' set to 'On', and 'RECEIVE NETWORK AUDIO' set to 'On'. Under 'BUZZER', there is one dropdown menu: 'REMOTE CONTROLLER' set to 'On'. Below the settings are 'APPLY' and 'CANCEL' buttons.

11.4.5. User

User Management :

You can add a user account and change the password.

NOTE: For details about each displayed item, please refer to Chapter 6.5. User Setting.

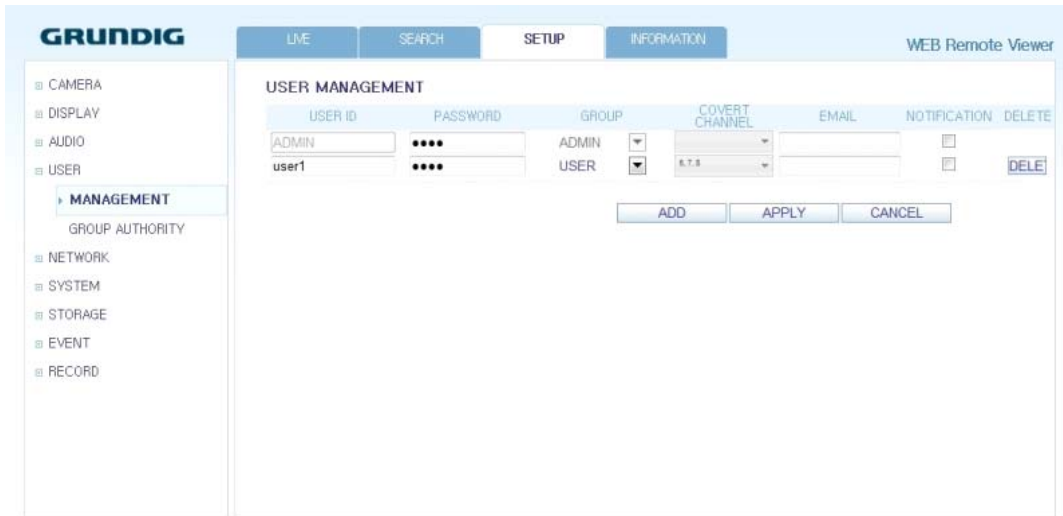

To add a user, click on <Add> and provide the user information. If you want to delete the user, click on next to it. When done, click on <OK> to apply the change.

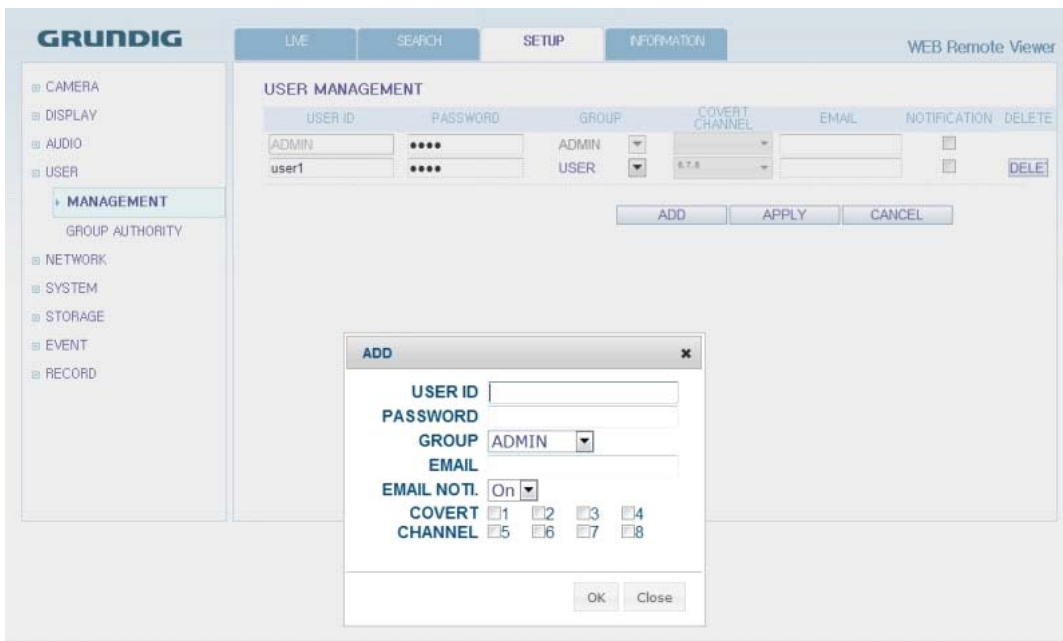

Group Permission Setting :

You can grant different user groups different permissions to a specific menu. Mark the checkboxes of the menu items accessible by the user group. When done, click on <OK> to apply the changes.

NOTE: For more information about the accessible menu items, refer to Chapter 6.5.2. Group Authority.

	Manager	User
SEARCH	<input checked="" type="checkbox"/>	<input type="checkbox"/>
ARCHIVING	<input type="checkbox"/>	<input type="checkbox"/>
SYSTEM SETUP	<input checked="" type="checkbox"/>	<input type="checkbox"/>
RECORD SETUP	<input checked="" type="checkbox"/>	<input type="checkbox"/>
EVENT ACTION CONTROL	<input checked="" type="checkbox"/>	<input checked="" type="checkbox"/>
LISTEN TO AUDIO	<input checked="" type="checkbox"/>	<input checked="" type="checkbox"/>
MIC	<input checked="" type="checkbox"/>	<input checked="" type="checkbox"/>
REMOTE LOG IN	<input type="checkbox"/>	<input type="checkbox"/>
SHUTDOWN	<input checked="" type="checkbox"/>	<input checked="" type="checkbox"/>

11.4.6. Network

Network Setting :

You can check the network connection status and change the baud rate. Change the maximum transfer rate and click on <OK> to apply it.

NOTE: For more information about each network entry, refer to Chapter 6.6.1. IP Setup.

DHCP

IP ADDRESS: 192.168.44.48

GATEWAY: 192.168.44.1

SUBNET MASK: 255.255.255.0

1ST DNS SERVER: 192.168.44.5

2ND DNS SERVER: 0.0.0.0

RTSP SERVICE PORT: 5554

WEB SERVICE PORT: 8080

MAX TX SPEED: MAX

DDNS Setting :

You can configure the DDNS settings so that remote users who are connected to the network can access the DVR remotely. Change the DDNS settings and click on <OK> to apply the changes.

The screenshot shows the Grundig web interface with the 'SETUP' tab selected. The left sidebar contains a menu with 'DDNS' highlighted under 'IP SETUP'. The main content area is titled 'DDNS' and contains the following fields:

DDNS	On
DDNS SERVER NAME	DVRLINK.NET
NVR NAME	00115f0b5ca3
NVR ADDRESS	00115f0b5ca3.DVRLINK.NET

At the bottom right of the form are 'APPLY' and 'CANCEL' buttons.

Email Setting :

You can register and test an email address so that an email notification is delivered at a specific interval or if an event occurs. Provide the necessary information and click on <OK> to apply it.

NOTE: For more information, refer to Chapter 6.6.3. Email.

The screenshot shows the Grundig web interface with the 'SETUP' tab selected. The left sidebar contains a menu with 'EMAIL' highlighted under 'IP SETUP'. The main content area is titled 'EMAIL' and contains the following fields:

SERVER	
PORT	25
SECURITY	OFF
USER	
PASSWORD	
TEST EMAIL	

At the bottom right of the form are 'APPLY' and 'CANCEL' buttons, and a 'TEST' button is located below the 'TEST EMAIL' field.

11.4.7. System

Date/Time Setting :

Specify the current date and time. When done, click on <OK> to apply the changes.

NOTE: For more information about each item of the time and date settings, refer to Chapter 6.7.1. Date/Time.

The screenshot shows the Grundig WEB Remote Viewer interface with the 'SETUP' tab selected. The left sidebar contains a tree view with 'DATE/TIME' highlighted. The main content area is titled 'DATE/TIME' and contains the following settings:

- DATE FORMAT: MM/DD/YYYY
- TIME FORMAT: 24 Hour
- NETWORK TIME SYNCHRONIZATION
 - NETWORK TIME SERVER SETUP: pool.ntp.org
 - AUTO TIME SYNC: OFF
 - SYNC AT: 0.00
- TIMEZONE / DST
 - TIME ZONE SETUP: GMT+00:00 Europe/London
 - DST: On

At the bottom right of the main content area, there are 'APPLY' and 'CANCEL' buttons.

System Management :

You can configure the access settings of: log in, log out, and auto logout.

The screenshot shows the Grundig WEB Remote Viewer interface with the 'SETUP' tab selected. The left sidebar contains a tree view with 'SYSTEM MANAGEMEN...' highlighted. The main content area is titled 'SYSTEM MANAGEMENT' and contains the following settings:

- PASSWORD: On
- EXPIRED TERM OF PASSWORD: Not Used
- AUTO LOGOUT: Off
- DURATION: 1 Min.
- POE POWER LIMIT: 72w
- AC POWER FREQUENCY: 60Hz

At the bottom right of the main content area, there are 'APPLY' and 'CANCEL' buttons.

System Information :

You can check the information of the system firmware version, disk space, and network settings, as well as the status information of the network connection and alarm I/O.

The screenshot shows the Grundig WEB Remote Viewer interface. The top navigation bar includes 'LIVE', 'SEARCH', 'SETUP', and 'INFORMATION'. The left sidebar lists menu items: CAMERA, DISPLAY, AUDIO, USER, NETWORK, SYSTEM (with sub-items DATE/TIME, SYSTEM MANAGEMENT, and SYSTEM INFORMATION), CONTROL DEVICE, STORAGE, EVENT, and RECORD. The main content area is titled 'SYSTEM INFORMATION' and contains the following data:

MODEL	GRI-K2208A
FW VERSION	20210.1.702013.108
LAST FW UPDATE DATE	N/A
HW VERSION	MIPN507A
DISK CAPACITY	465.8 GB
DISK USAGE	456.4 GB
NUMBER OF DISKS	2
IP ADDRESS	192.168.44.48
MAC ADDRESS	00115f0b5ca3
DDNS ADDRESS	00115f0b5ca3.DVRLINK.NET
RTSP SERVICE PORT	5554
WEB SERVICE PORT	8080
RESOLUTION	HDMI(1080P-60)

Below the system information is a 'STATUS' section with a grid of indicator lights:

- CAMERA CONNECTION: 1 (red), 2-9 (blue)
- ALARM IN (CAMERA): 1-9 (blue)
- ALARM IN (NVR): 1-2 (blue)
- ALARM OUT (CAMERA): 1-9 (blue)
- ALARM OUT (NVR): 1 (blue)

Control Device Setting :

Set the connection of both, the remote control and the keyboard control. Change the communication settings and click on <OK> to apply the changes.

NOTE: For more information about each communication item, refer to Chapter 6.7.4. Control Device.

The screenshot shows the Grundig WEB Remote Viewer interface. The top navigation bar includes 'LIVE', 'SEARCH', 'SETUP', and 'INFORMATION'. The left sidebar lists menu items: CAMERA, DISPLAY, AUDIO, USER, NETWORK, SYSTEM (with sub-items DATE/TIME, SYSTEM MANAGEMENT, and SYSTEM INFORMATION), CONTROL DEVICE, STORAGE, EVENT, and RECORD. The main content area is titled 'CONTROL DEVICE' and contains the following settings:

DEVICE	SYSTEM ID	PROTOCOL	BAUD RATE
0		D-Max	9600

Buttons for 'APPLY' and 'CANCEL' are located at the bottom right of the settings area.

11.4.8. Storage

Device Information :

You can check a list of internal/external storage devices connected to the NVR as well as the recording time information of each device.

The screenshot shows the Grundig NVR web interface. The left sidebar contains a menu with options: CAMERA, DISPLAY, AUDIO, USER, NETWORK, SYSTEM, STORAGE, DISK INFORMATION (selected), S.M.A.R.T. SETUP, EVENT, and RECORD. The main content area is titled 'DISK INFORMATION' and has tabs for 'internal' and 'external'. Below the tabs is a table with the following data:

	START TIME	END TIME	STATUS	CAPACITY	MODEL	S.M.A.R.T. STATUS
ALL	08-22-2012 10:42:45	09-13-2012 15:42:08	-	-	-	-
DISK 1	08-22-2012 10:42:45	09-10-2012 18:48:13	IN USE	233 GB	Hitachi HDS7	NORMAL
DISK 2	09-04-2012 13:14:11	09-13-2012 15:42:08	IN USE	233 GB	Hitachi HDS7	NORMAL
DISK 3	-	-	-	-	-	-
DISK 4	-	-	-	-	-	-
DISK 5	-	-	-	-	-	-

Below the table is the 'OPERATIONS' section with the following settings:

- START TIME: 08-22-2012 10:42:45
- END TIME: 09-13-2012 15:42:08
- DISK WRITE MODE: Overwrite
- RECORDING TIME LIMIT: OFF

S.M.A.R.T. Status :

You can check the S.M.A.R.T. status for each of the internal and external devices.

What is S.M.A.R.T.?

It is a sort of HDD self-diagnosis tool that detects any error on the system and alerts the user if an error occurs.

The screenshot shows the Grundig NVR web interface. The left sidebar contains a menu with options: CAMERA, DISPLAY, AUDIO, USER, NETWORK, SYSTEM, STORAGE, DISK INFORMATION, S.M.A.R.T. SETUP (selected), EVENT, and RECORD. The main content area is titled 'S.M.A.R.T. SETUP' and has tabs for 'internal' and 'external'. Below the tabs is a table with the following data:

S.M.A.R.T. STATUS	Disk 1	Disk 2	Disk 3	Disk 4	Disk 5
	NORMAL	NORMAL	-	-	-

There is a 'DETAIL' button below the table.

11.4.9. Sensor

Alarm Output :

Specify the alarm output conditions with the work schedule. When done, click on <OK> to apply the changes.

NOTE: For more information about the alarm output and ON/OFF schedule, refer to Chapter 6.9.1. Alarm Out.

	NAME	TYPE	OPERATION	DURATION
1	CAM-AO1	DIGITAL OUT	N/O	5 sec
2	CAM-AO2	DIGITAL OUT	N/O	5 sec
3	CAM-AO3	DIGITAL OUT	N/O	5 sec
4	CAM-AO4	DIGITAL OUT	N/O	5 sec
5	CAM-AO5	DIGITAL OUT	N/O	5 sec
6	CAM-AO6	DIGITAL OUT	N/O	5 sec
7	CAM-AO7	DIGITAL OUT	N/O	5 sec
8	CAM-AO8	DIGITAL OUT	N/O	5 sec
AO1	AO1	DIGITAL OUT	N/O	5 sec

DAY: Sun

Legend: OFF (black), ON (red), EVENT (yellow)

	0	1	2	3	4	5	6	7	8	9	10	11	12	13	14	15	16	17	18	19	20	21	22	23
1	EVENT	EVENT	EVENT	EVENT	EVENT	EVENT	EVENT	EVENT	EVENT	EVENT	EVENT	EVENT	EVENT	EVENT	EVENT	EVENT	EVENT	EVENT	EVENT	EVENT	EVENT	EVENT	EVENT	EVENT
2	EVENT	EVENT	EVENT	EVENT	EVENT	EVENT	EVENT	EVENT	EVENT	EVENT	EVENT	EVENT	EVENT	EVENT	EVENT	EVENT	EVENT	EVENT	EVENT	EVENT	EVENT	EVENT	EVENT	EVENT
3	EVENT	EVENT	EVENT	EVENT	EVENT	EVENT	EVENT	EVENT	EVENT	EVENT	EVENT	EVENT	EVENT	EVENT	EVENT	EVENT	EVENT	EVENT	EVENT	EVENT	EVENT	EVENT	EVENT	EVENT
4	EVENT	EVENT	EVENT	EVENT	EVENT	EVENT	EVENT	EVENT	EVENT	EVENT	EVENT	EVENT	EVENT	EVENT	EVENT	EVENT	EVENT	EVENT	EVENT	EVENT	EVENT	EVENT	EVENT	EVENT
5	EVENT	EVENT	EVENT	EVENT	EVENT	EVENT	EVENT	EVENT	EVENT	EVENT	EVENT	EVENT	EVENT	EVENT	EVENT	EVENT	EVENT	EVENT	EVENT	EVENT	EVENT	EVENT	EVENT	EVENT
6	EVENT	EVENT	EVENT	EVENT	EVENT	EVENT	EVENT	EVENT	EVENT	EVENT	EVENT	EVENT	EVENT	EVENT	EVENT	EVENT	EVENT	EVENT	EVENT	EVENT	EVENT	EVENT	EVENT	EVENT
7	EVENT	EVENT	EVENT	EVENT	EVENT	EVENT	EVENT	EVENT	EVENT	EVENT	EVENT	EVENT	EVENT	EVENT	EVENT	EVENT	EVENT	EVENT	EVENT	EVENT	EVENT	EVENT	EVENT	EVENT
8	EVENT	EVENT	EVENT	EVENT	EVENT	EVENT	EVENT	EVENT	EVENT	EVENT	EVENT	EVENT	EVENT	EVENT	EVENT	EVENT	EVENT	EVENT	EVENT	EVENT	EVENT	EVENT	EVENT	EVENT
AO1	EVENT	EVENT	EVENT	EVENT	EVENT	EVENT	EVENT	EVENT	EVENT	EVENT	EVENT	EVENT	EVENT	EVENT	EVENT	EVENT	EVENT	EVENT	EVENT	EVENT	EVENT	EVENT	EVENT	EVENT

Event Notification :

Specify the notification method using one of <BUZZER OUT>, <DISPLAY> and <EMAIL> against an event alarm that occurs. Specify the buzzer output time, display time and email notification, and click on <OK> to apply the changes.

NOTE: For more information about the event notification, refer to Chapter 6.9.2. Event Notification.

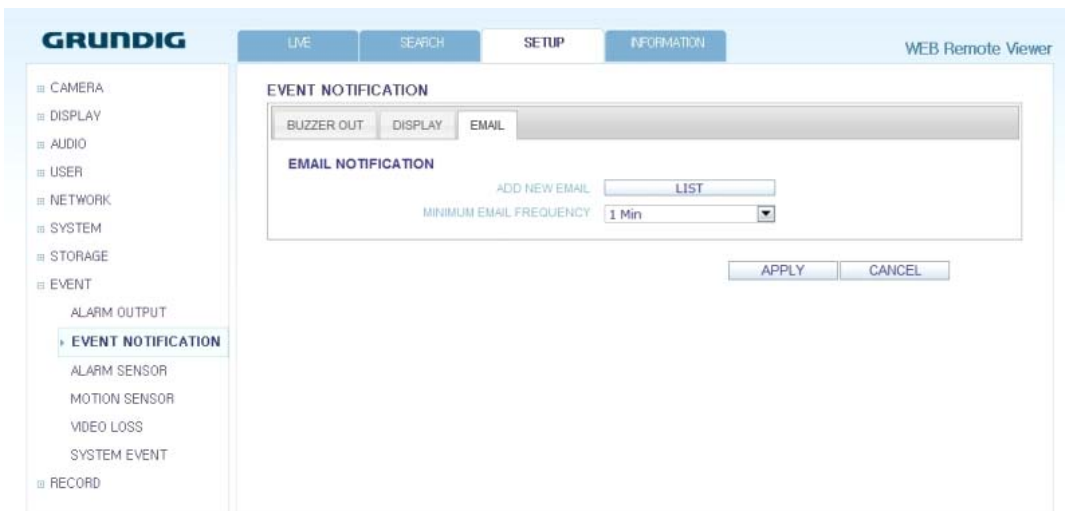
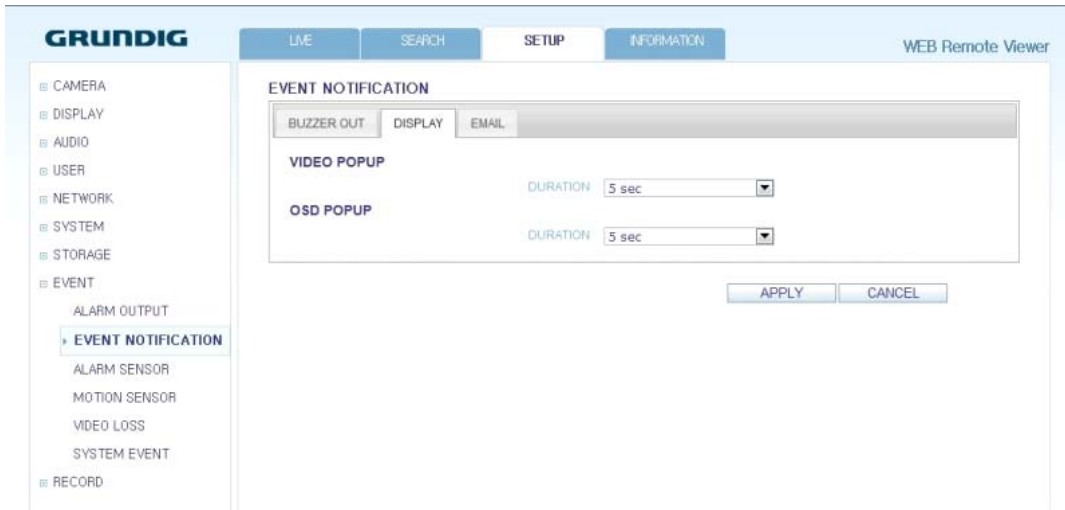
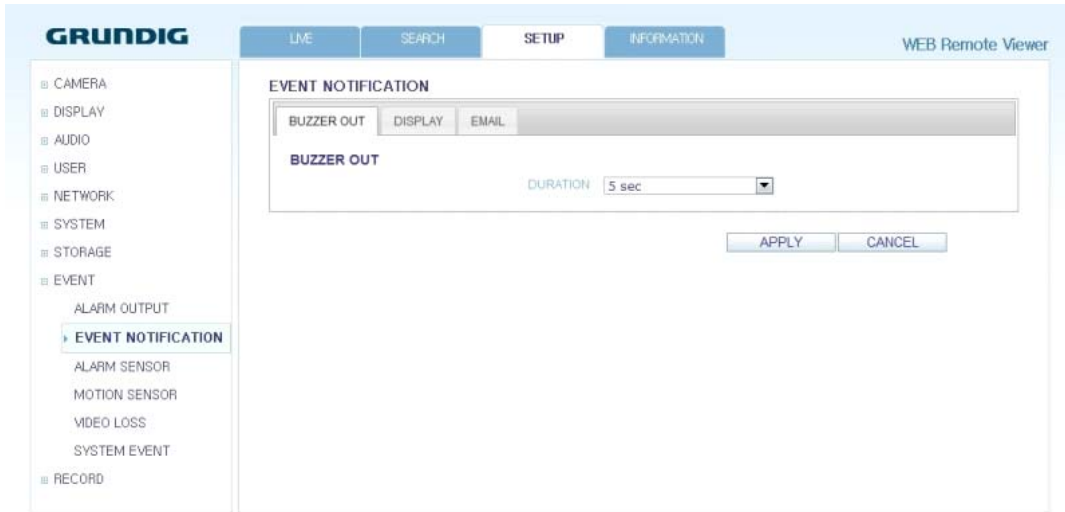

Alarm Sensor :

You can configure the settings of the alarm sensor and specify the operation of the sensor if an event occurs. When done, click on <OK> to apply the changes.

NOTE: For more information about each of the alarm sensor actions, refer to Chapter 6.9.3. Alarm Sensor.

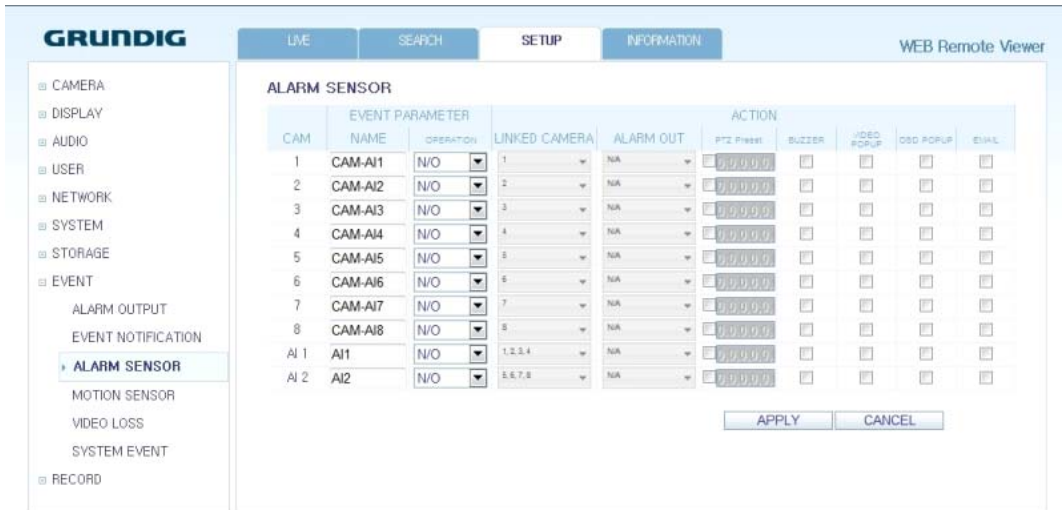

Motion Sensor :

You can set an action to execute when a motion is detected. When done, click on <OK> to apply the changes.

NOTE: For more information about how to set the motion sensor, refer to Chapter 6.9.4. Motion Sensor.



Video Loss :

You can select an action for <BUZZER> and <EMAIL> and determine what to do on the alarm output port if no video is received from the camera. When done, click on <OK> to apply the changes.



System Event :

You can set which action to perform if an event related to disk, recording, network or system happens. You may want to notify the user of the event using the alarm output, buzzer, OSD pop-up and email.

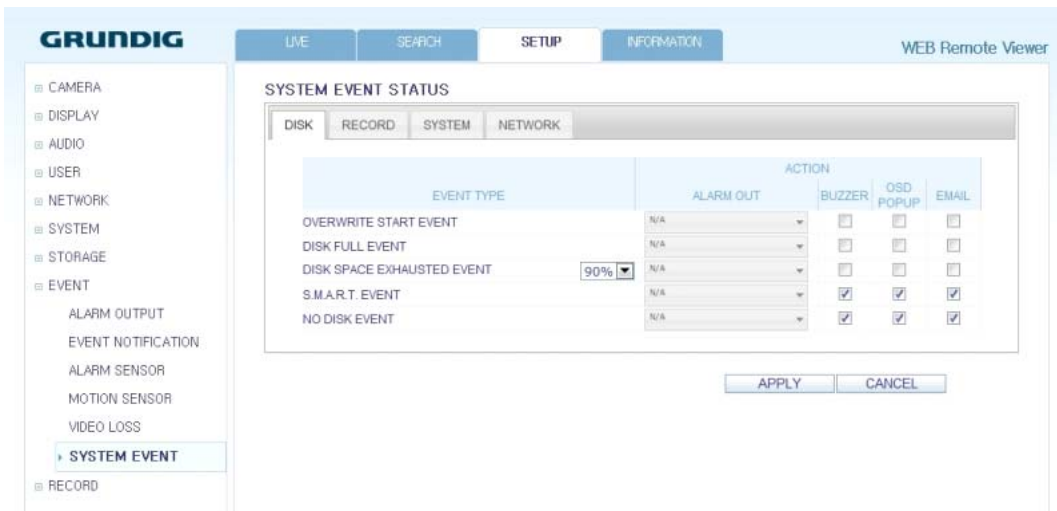

When done, click on <OK> to apply the changes.

NOTE: For more information about how to set the system event, refer to Chapter 6.9.6. System Event.

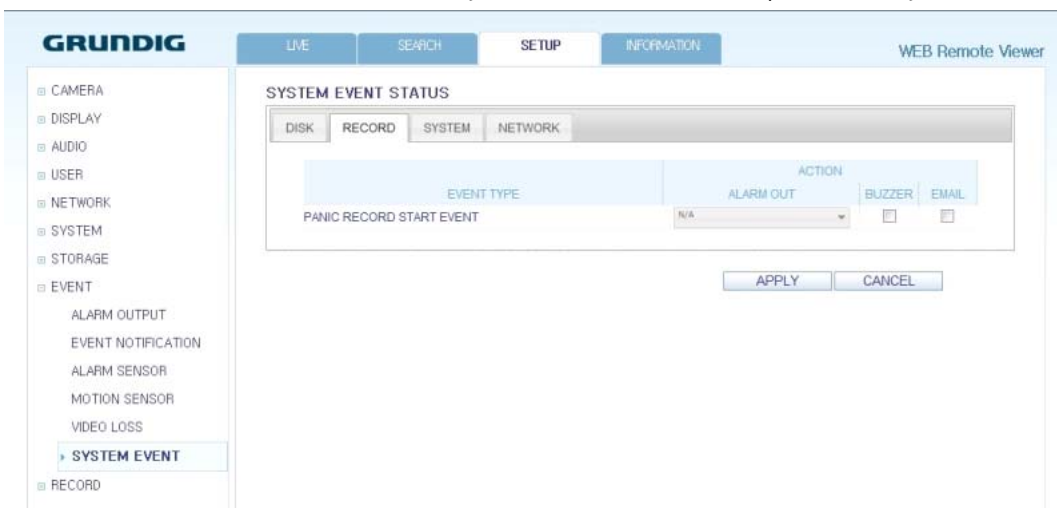

GRUNDIG LIVE SEARCH SETUP INFORMATION WEB Remote Viewer

SYSTEM EVENT STATUS

DISK RECORD SYSTEM NETWORK

EVENT TYPE	ACTION			
	ALARM OUT	BUZZER	OSD POPUP	EMAIL
BOOTING EVENT	N/A	<input checked="" type="checkbox"/>	<input type="checkbox"/>	<input checked="" type="checkbox"/>
LOGIN FAIL EVENT	RETRY 3 TIMES	<input checked="" type="checkbox"/>	<input type="checkbox"/>	<input checked="" type="checkbox"/>
FAN FAIL EVENT	N/A	<input checked="" type="checkbox"/>	<input checked="" type="checkbox"/>	<input checked="" type="checkbox"/>
TEMPERATURE FAIL EVENT	N/A	<input checked="" type="checkbox"/>	<input checked="" type="checkbox"/>	<input checked="" type="checkbox"/>
POE FAIL EVENT	90%	<input checked="" type="checkbox"/>	<input checked="" type="checkbox"/>	<input checked="" type="checkbox"/>

APPLY CANCEL

GRUNDIG LIVE SEARCH SETUP INFORMATION WEB Remote Viewer

SYSTEM EVENT STATUS

DISK RECORD SYSTEM NETWORK

EVENT TYPE	ACTION		
	ALARM OUT	BUZZER	EMAIL
TROUBLE IN INTERNET CONNECTION	N/A	<input type="checkbox"/>	<input type="checkbox"/>
FAIL IN REMOTE LOGIN	RETRY 3 TIMES	<input type="checkbox"/>	<input type="checkbox"/>
FAIL IN DDNS UPDATE	RETRY 3 TIMES	<input type="checkbox"/>	<input type="checkbox"/>

APPLY CANCEL

11.4.10. Record Setup

Record Setting :

You can set the recording options for Auto or Manual mode.

GRUNDIG LIVE SEARCH SETUP INFORMATION WEB Remote Viewer

RECORDING CONFIGURATION MODE

MODE: Manual

MANUAL CONFIGURATION OPTIONS

SCHEDULE MODE: Daily

PRE EVENT RECORDING TIME: 5 Sec

POST EVENT RECORDING TIME: 30 Sec

PANIC RECORDING OPTIONS

PANIC RECORDING TIME: Manual

APPLY CANCEL

When done, click on <OK> to apply the changes.

NOTE: For more information about how to set each mode, refer to 7.2.1. Operation Mode.

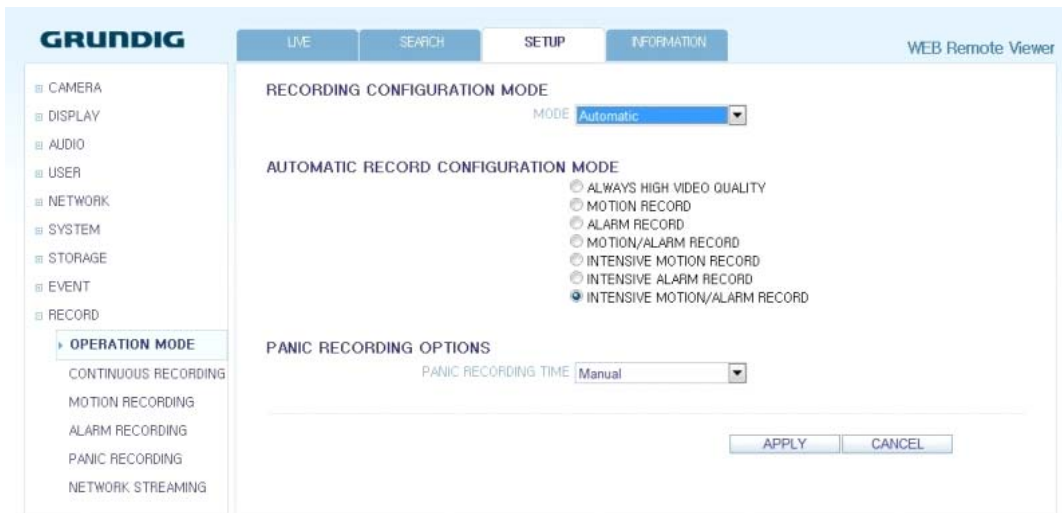

Continuous Recording :

You can configure the settings of: continuous recording time, recording size, frame rate per second and quality. Click on the 'Arrow pointing to the bottom' next to each item to display the list of values available.

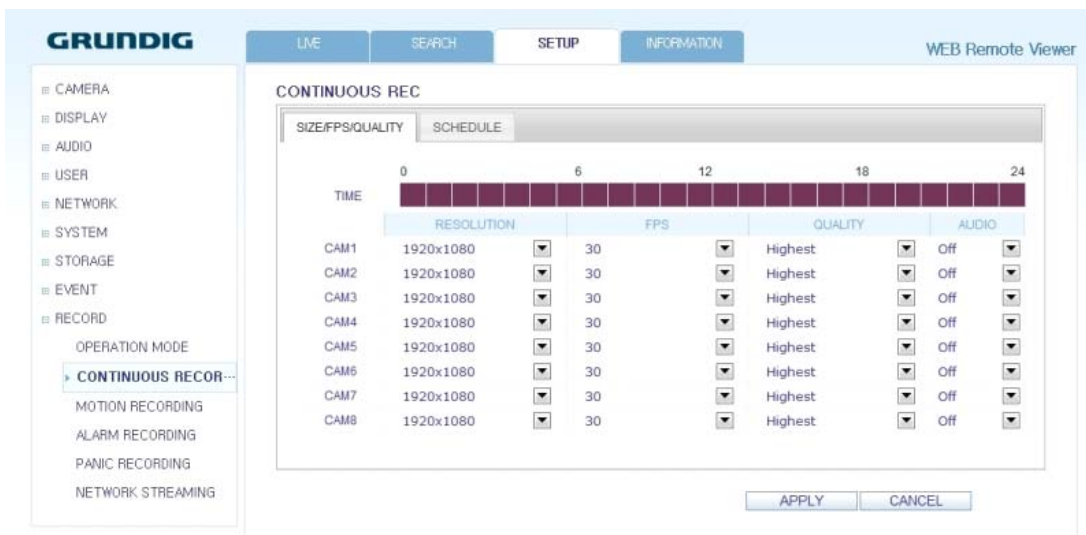

When you complete the recording size and schedule settings, click on <OK> to apply your settings.

NOTE: For more information about the continuous recording size and schedule, refer to Chapter 7.2.2. Continuous Recording.



Motion Recording :

Set the <SIZE/FPS/QUALITY/AUDIO> and the <SCHEDULE> to apply if a motion event occurs. Click on the 'Arrow pointing to the bottom' next to each item to display the list of values available.

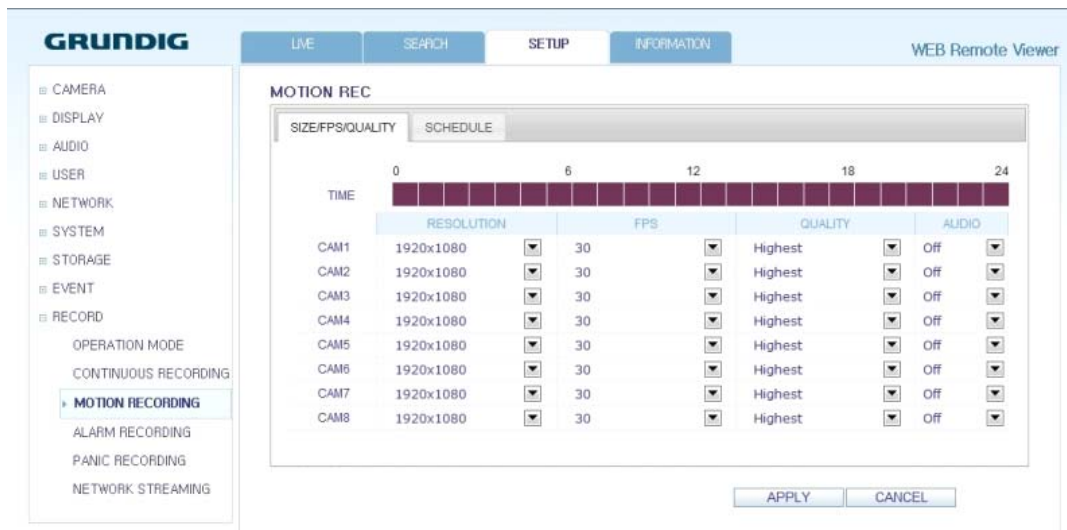

Complete the setting of <SIZE/FPS/QUALITY/AUDIO> for the motion recording as well as <SCHEDULE>, and click on <OK> to apply the changes.

NOTE: For more information about the motion recording size and schedule, refer to Chapter 7.2.3. Motion Recording.

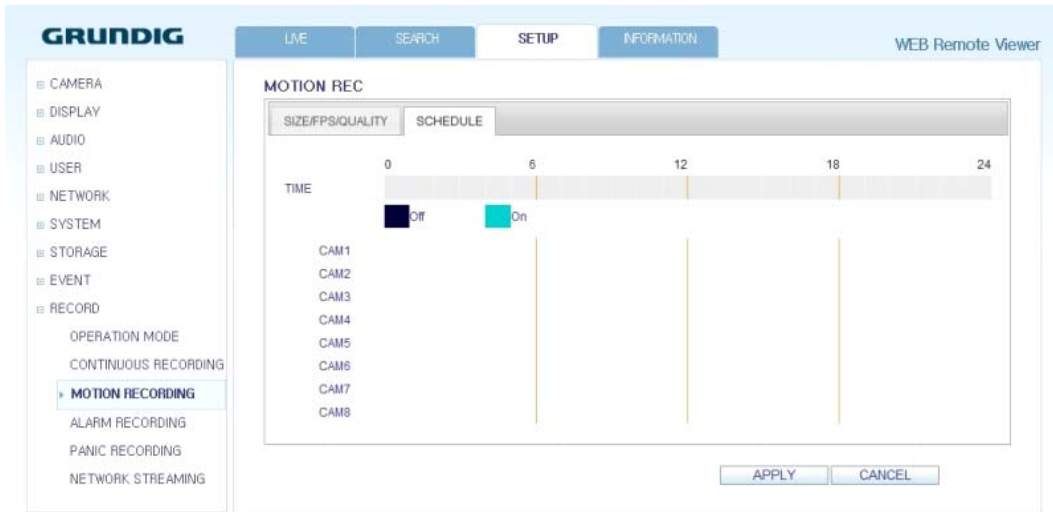

Alarm Recording :

Set <SIZE/FPS/QUALITY/AUDIO> and <SCHEDULE> to apply if an alarm event occurs. Click on the 'Arrow pointing to the bottom' next to each item to display the list of values available.

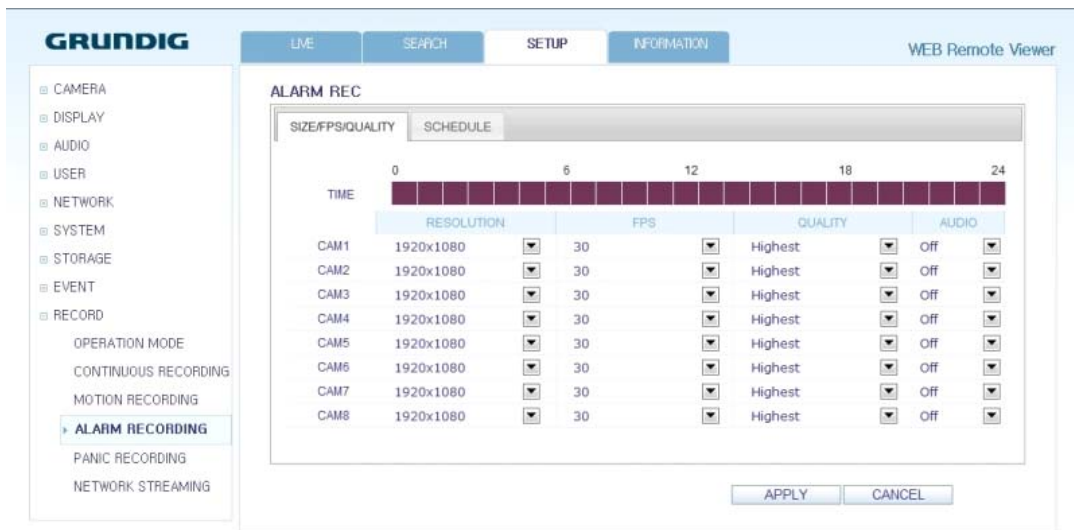

Complete the setting of <SIZE/FPS/QUALITY/AUDIO> for the alarm recording as well as <SCHEDULE>, and click on <OK> to apply the changes.

NOTE: For more information about the alarm recording size and schedule, refer to Chapter 7.2.4. Alarm Recording.

Panic Recording :

From the <PANIC RECORD> menu, you can set the resolution, FPS, quality and audio settings according to your preference. Click on the 'Arrow pointing to the bottom' next to each item to display the list of values available. When you have completed the manual record settings, click on <OK> to apply the changes.

NOTE: For more information about the manual record settings, refer to Chapter 7.2.5. Panic Recording.



Network Streaming :

You can specify the maximum size of network streaming and video resolution for remote users and change the FPS. Click on the 'Arrow pointing to the bottom' next to each item to display the list of values available. When done, click on <OK> to apply the settings.



11.4.11. About

Click on the <INFORMATION> tab to check the model name of the NVR as well as the web viewer version.



12. Archive Viewer

You can playback here the data archived in the NVR.

And you can playback the HDD data recorded by the NVR.

12.1. Starting the Backup Player

1. Connect the NVR to the backup USB storage device and store the backup on it.
2. Connect the USB storage device with your PC. Open the folder saving the archived images.

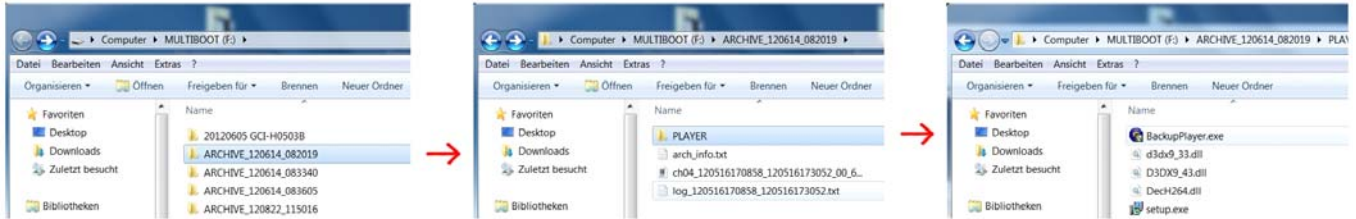

3. Start the Backup Player.

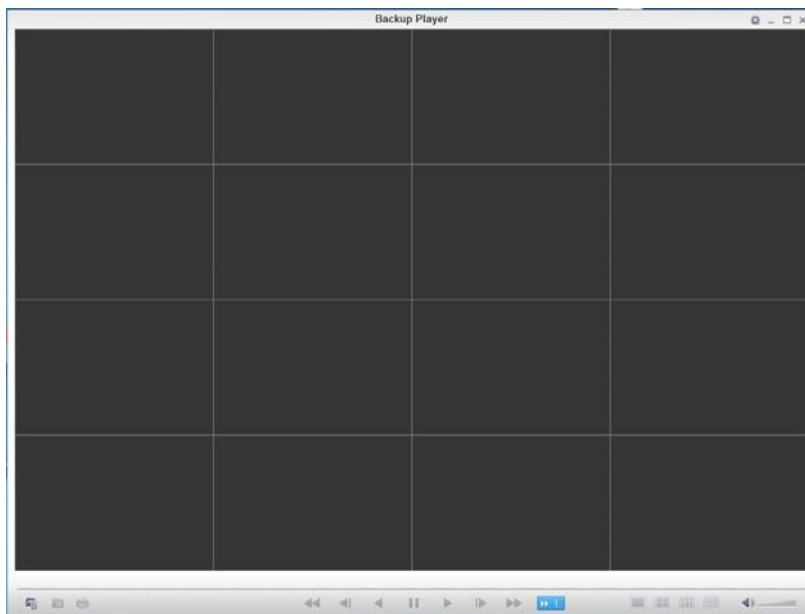

4. Click on the 'Open Folder' button in the bottom left corner to display the file browser. Select the archived file to play back.

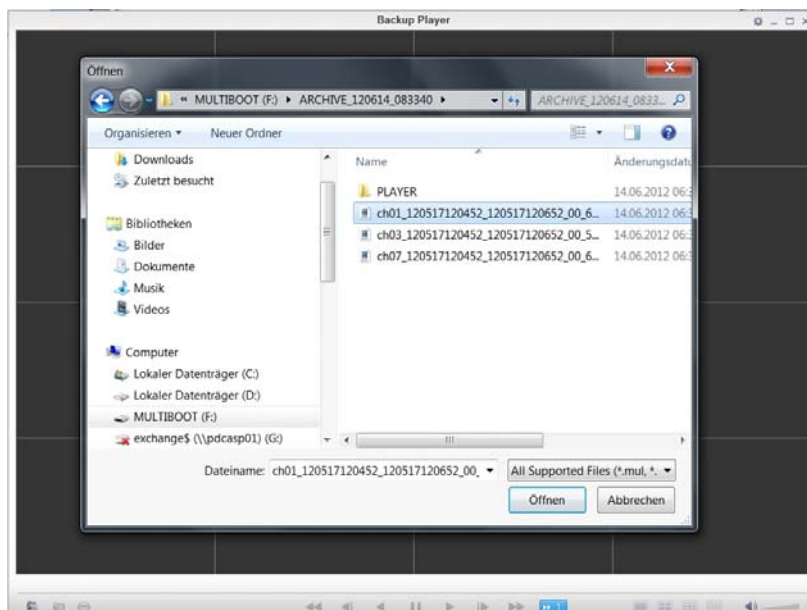

-
5. Check the integrity of the archived file.
 6. When done, the archived file will be played on the screen.

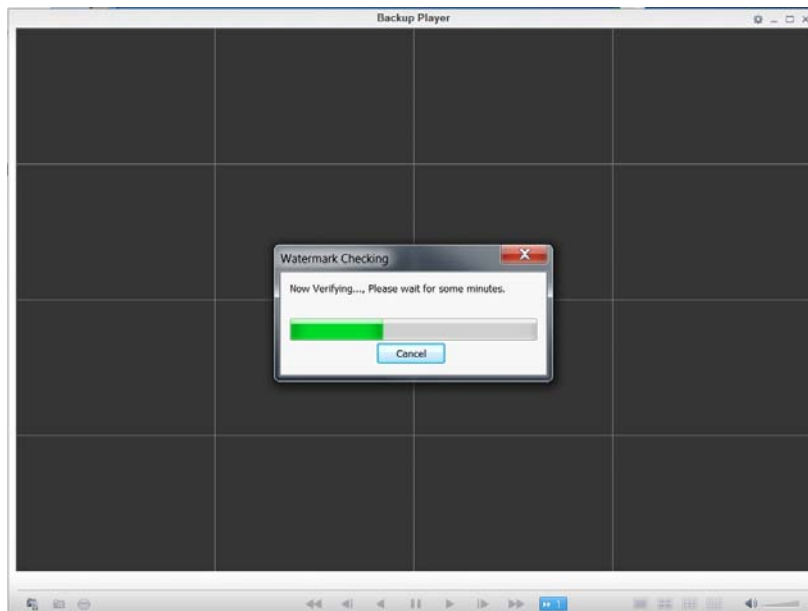
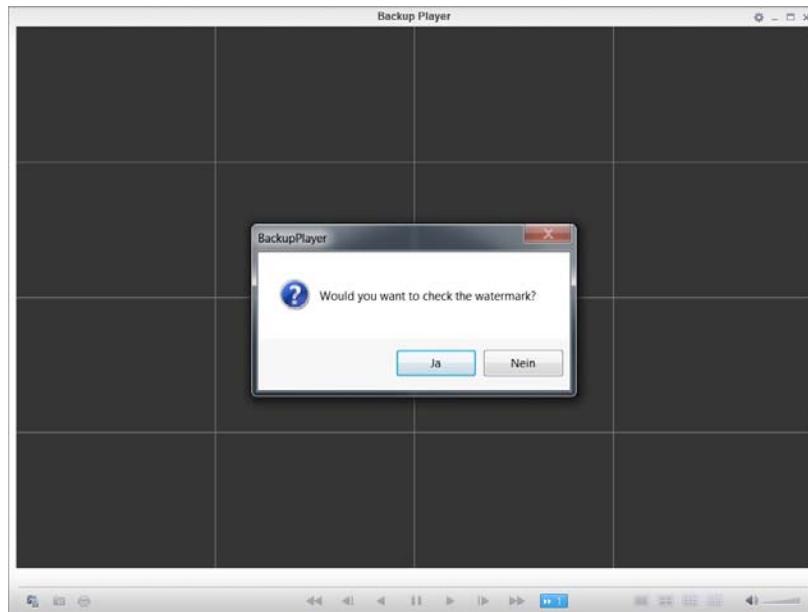

12.2. Backup Player At a Glance

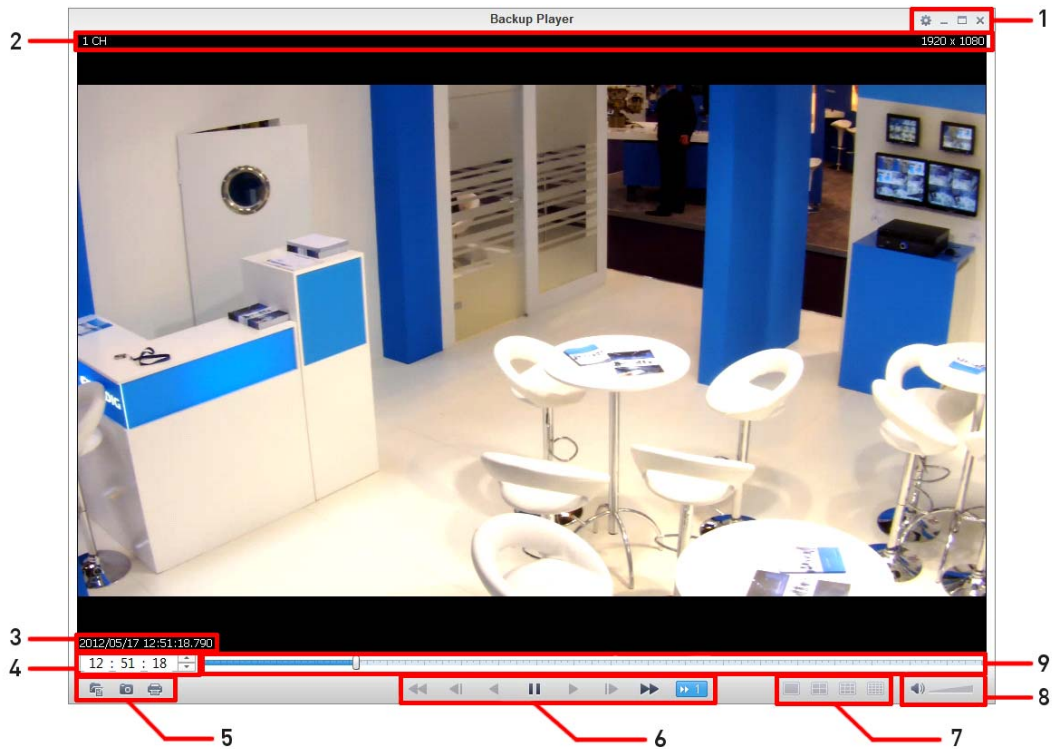

No.	Item	Description
1	Setup	Configure the environment settings.
	Minimise, Close	Minimise or close the Backup Player.
2	Channel Information	Shows the channel information and the video resolution.
3	Play Time	Displays the time of the current video image.
4	Play Time	Displays the current playback time.
5	File Search	Opens the file that you backed up.
	Capture	Capture the current screen.
	Print	Print out the current screen.
6	Playback Control	Control the playback direction and speed of the current video. For more information about how to use the playback control buttons, refer to "Using the Playback Bar" (Chapter 9.1.1. "Playback Screen Configuration").
7	Split Mode	Switches to 1-/4-/8-/16-split screen mode.
8	Audio Setting	Shows the sound signal status and volume level.
9	Playback Bar	Displays the current playback position in the video.

12.2.1. Video Capture

Click on the 'Camera' button in the left corner at the bottom of the screen to capture the current video image.

- > Selected Video : Capture the actual frame of the current video.
- > Screen : Capture the visible portion of the current video.
- > Format : Select a saving format (BMP, JPG, PNG).
- > Path : Specify the saving path.
 - Default location : My Documents\My Pictures

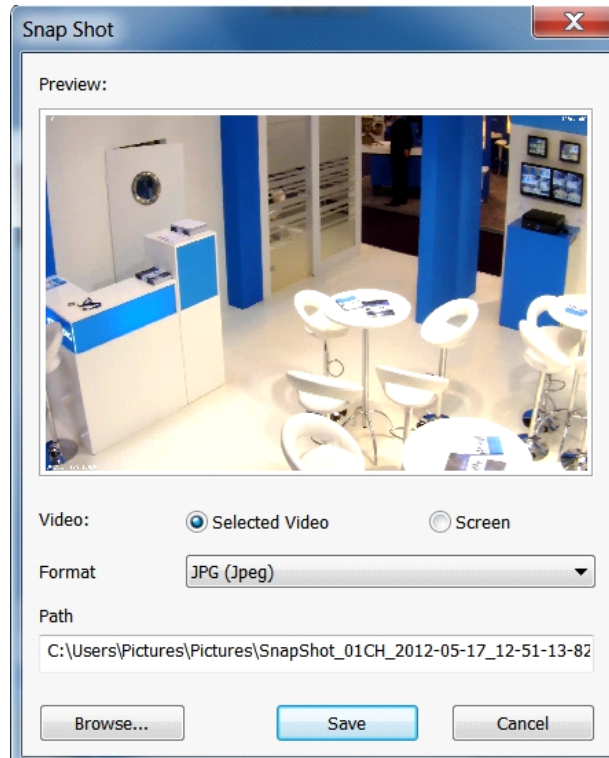

12.2.2. Print Out

Click on the 'Printer' button in the left corner at the bottom of the screen to print out the image. When the "Print" window appears, check the preview and click on <Print>.

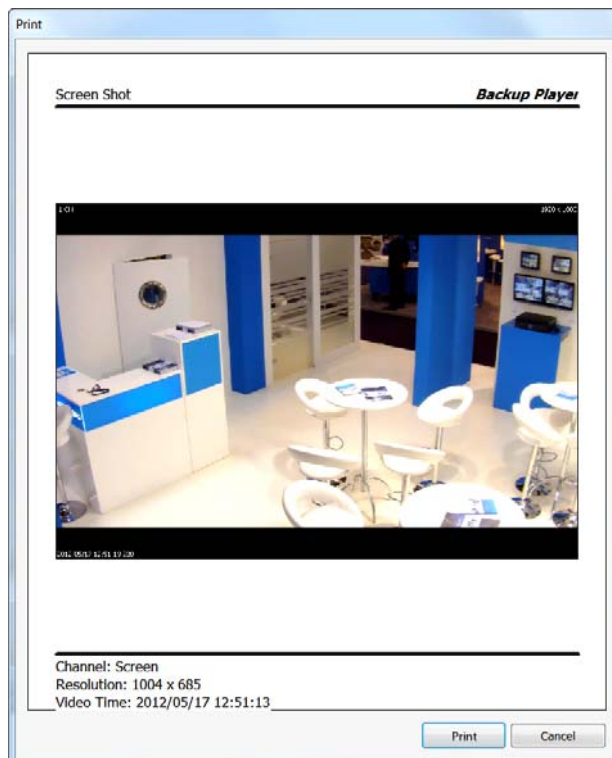

12.2.3. Settings

Click on the 'Rhombus' button to configure the Backup Player settings. You can check the version of the Backup Player.

> Maintain the image aspect ratio : Preserve the aspect ratio of the image. If you do not mark this option, the image will be adjusted to fit the screen.

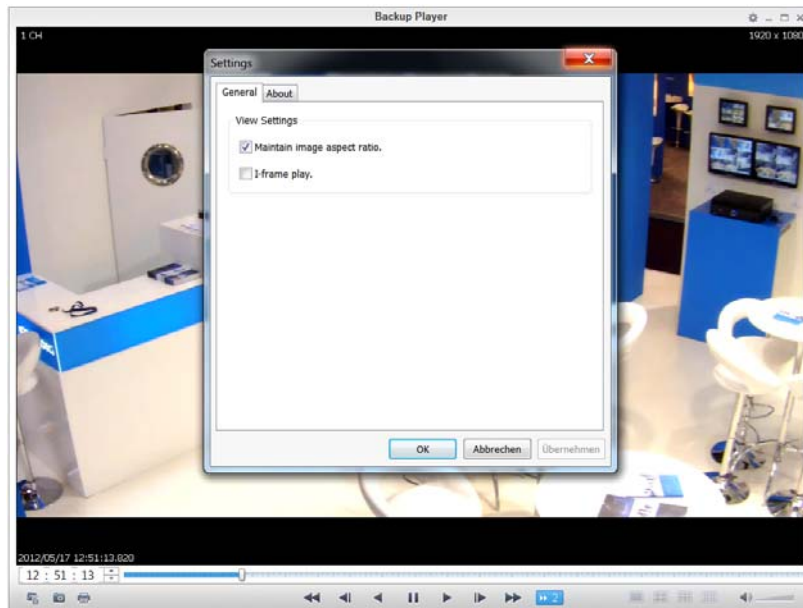

> About : You can check the program information including the current version.

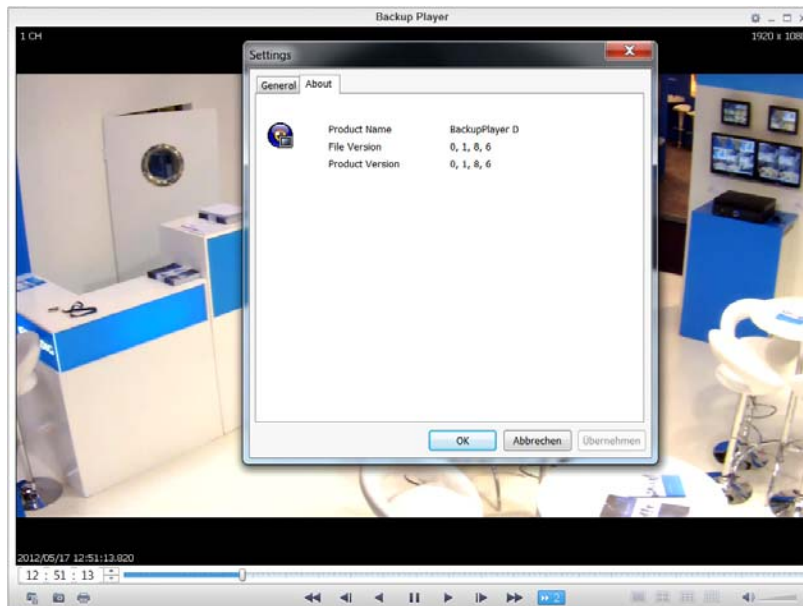

Specifications GRI-K1104A

Operating System	Embedded Linux
IP Inputs	4 channels
Recording Resolution	max. 1920x1080 depending on the camera performance
Recording Speed	100 fps
Video Compression	H.264
Storage Max. Expansion	17.5 TB (2x2,5 TB SATA and 5x2,5 TB eSATA)
Video Outputs	1 HDMI
Display Resolution	1920 x 1080
Display Speed	100 fps
Display Mode	Full screen, 4
PTZ Control	Pan/Tilt/Zoom/Focus/Preset/Sequence, Pelco D/P
Recording Mode	Continuous, Event Alarm, Motion, Video Loss, Schedule, Manual
Event Source	Motion, Alarm, Video Loss, System
Event Action	Pop-Up, Relay, E-Mail, Buzzer
Motion Detection	Selectable per camera with adjustable detection zones for alarm transmission and event-triggered recording (HDD)
Pre-Alarm	Off, 1, 2, 3, 4, 5, sec.
Post-Alarm	Off, 5, 10, 20, 30, sec., 1, 3 min.
Search Mode	Date/Time, Event, Thumbnail
Number of Clients	Up to 8 user (admin, manager, user)
Audio Inputs	4 CH over IP
Audio Outputs	1 CH, RCA
Audio Compression	G.711
Alarm Inputs	4 (IP) + 2 N/O or N/C
Alarm Outputs	1 Relay
Network	2 x 1000Mbps + 4 x 100Mbps (PoE)
Serial Interface(s)	1x RS232, 1x RS485, 3x USB, 1x eSATA
Multiplex Function	Triplex
Network Protocol	DHCP, HTTP, FTP, SMTP, RTP/RSTP, RTCP, NTP, DDNS, uPNP
Time Setting	Setting by NTP Server local or internet
Client software	Windows 2000, XP, Vista, 7 Web Viewer (Internet explorer)
SDK	HTTP API (PC Codec library)
Operating Temperature	0°C ~ +40°C
Humidity	10 ~ 90% no condensation
Supply Voltage	12 VDC (NVR), 48VDC (Switch)
Power Consumption	max.36W
Weight	4.09 kg
Dimensions (wxhxd)	305 x 44 x 298 mm

Specifications GRI-K2208A

IP Inputs	8 channels
Recording Speed	200 fps
Display Speed	200 fps
Display Mode	Full screen, 4, 8
Audio Inputs	8 CH over IP
Alarm Inputs	8 (IP) + 2 N/O or N/C
Network	2 x 1000Mbps + 8 x 100Mbps (PoE)
Power Consumption	max.50W
Weight	4.11 kg
Dimensions (wxhxd)	305 x 44 x 298 mm

Specifications GRI-K4416A

IP Inputs	16 channels
Recording Speed	400 fps
Storage Max. Expansion	25 TB (5x2,5 TB SATA and 5x2,5 TB eSATA)
Video Outputs	1 VGA, 1 HDMI
Display Speed	400 fps
Display Mode	Full screen, 4, 8, 9, 16
Audio Inputs	16 CH over IP
Alarm Inputs	16 (IP) + 2 N/O or N/C
Network	2 x 1000Mbps + 8 x 100Mbps (PoE)
Power Consumption	max.100W
Dimensions (wxhxd)	430 x 88 x 360 mm

EC Declaration of Conformity



GRI-K1104A 4-Ch Full HD Standalone H.264 NVR
GRI-K2208A 8-Ch Full HD Standalone H.264 NVR
GRI-K4416A 16-Ch Full HD Standalone H.264 NVR

It is hereby certified that the products meet the standards in the following relevant provisions:

EC EMC Directive 2004/108/EC

Applied harmonised standards and technical specifications:

EN 55022 : 2006 / A1 : 2007
EN 50130-4 : 1995 / A2 : 2003

ASP AG

Lüttringhauser Str. 9
42897 Remscheid
Germany

GRUNDIG

Remscheid, 14.12.2012

Ludwig Bergschneider
CEO

Open Source License Report on the Product

The software included in this product contains copyrighted software that is licensed under the GPL/LGPL.

GPL Software : linux kernel, busybox, cdrtools, dvd+rw-tools, smartctl, uboot, bash, udev, sysklogd

LGPL Software : glibc, vmstat, glib, gtk, libESMTP, iconv, gstreamer, pango,

OpenSSL License : OpenSSL

GNU GENERAL PUBLIC LICENSE

Version 2, June 1991

Copyright (C) 1989, 1991 Free Software Foundation, Inc.
51 Franklin Street, Fifth Floor, Boston, MA 02110-1301, USA

Everyone is permitted to copy and distribute verbatim copies of this license document, but changing it is not allowed.

Preamble

The licenses for most software are designed to take away your freedom to share and change it. By contrast, the GNU General Public License is intended to guarantee your freedom to share and change free software--to make sure the software is free for all its users. This General Public License applies to most of the Free Software Foundation's software and to any other program whose authors commit to using it. (Some other Free Software Foundation software is covered by the GNU Lesser General Public License instead.) You can apply it to your programs, too.

When we speak of free software, we are referring to freedom, not price. Our General Public Licenses are designed to make sure that you have the freedom to distribute copies of free software (and charge for this service if you wish), that you receive source code or can get it if you want it, that you can change the software or use pieces of it in new free programs; and that you know you can do these things.

To protect your rights, we need to make restrictions that forbid anyone to deny you these rights or to ask you to surrender the rights. These restrictions translate to certain responsibilities for you if you distribute copies of the software, or if you modify it.

For example, if you distribute copies of such a program, whether gratis or for a fee, you must give the recipients all the rights that you have. You must make sure that they, too, receive or can get the source code. And you must show them these terms so they know their rights.

We protect your rights with two steps: (1) copyright the software, and (2) offer you this license which gives you legal permission to copy, distribute and/or modify the software.

Also, for each author's protection and ours, we want to make certain that everyone understands that there is no warranty for this free software. If the software is modified by someone else and passed on, we want its recipients to know that what they have is not the original, so that any problems introduced by others will not reflect on the original authors' reputations.

Finally, any free program is threatened constantly by software patents. We wish to avoid the danger that redistributors of a free program will individually obtain patent licenses, in effect making the program proprietary. To prevent this, we have made it clear that any patent must be licensed for everyone's free use or not licensed at all.

The precise terms and conditions for copying, distribution and modification follow.

TERMS AND CONDITIONS FOR COPYING, DISTRIBUTION AND MODIFICATION

Version 2, June 1991, Copyright (C) 1989, 1991 Free Software Foundation, Inc. 51 Franklin S

0. This License applies to any program or other work which contains a notice placed by the copyright holder saying it may be distributed under the terms of this General Public License. The "Program", below, refers to any such program or work, and a "work based on the Program" means either the Program or any derivative work under copyright law: that is to say, a work containing the Program or a portion of it, either verbatim or with modifications and/or translated into another language. (Hereinafter, translation is included without limitation in the term "modification".) Each licensee is addressed as "you".

Activities other than copying, distribution and modification are not covered by this License; they are outside its scope. The act of running the Program is not restricted, and the output from the Program is covered only if its contents constitute a work based on the Program (independent of having been made by running the Program). Whether that is true depends on what the Program does.

1. You may copy and distribute verbatim copies of the Program's source code as you receive it, in any medium, provided that you conspicuously and appropriately publish on each copy an appropriate copyright notice and disclaimer of warranty; keep intact all the notices that refer to this License and to the absence of any warranty; and give any other recipients of the Program a copy of this License along with the Program.

You may charge a fee for the physical act of transferring a copy, and you may at your option offer warranty protection in exchange for a fee.

2. You may modify your copy or copies of the Program or any portion of it, thus forming a work based on the Program, and copy and distribute such modifications or work under the terms of Section 1 above, provided that you also meet all of these conditions:

a) You must cause the modified files to carry prominent notices stating that you changed the files and the date of any change.

b) You must cause any work that you distribute or publish, that in whole or in part contains or is derived from the Program or any part thereof, to be licensed as a whole at no charge to all third parties under the terms of this License.

c) If the modified program normally reads commands interactively when run, you must cause it, when started running for such interactive use in the most ordinary way, to print or display an announcement including an appropriate copyright notice and a notice that there is no warranty (or else, saying that you provide a warranty) and that users may redistribute the program under these conditions, and telling the user how to view a copy of this License. [Exception: if the Program itself is interactive but does not normally print such an announcement, your work based on the Program is not required to print an announcement.]

These requirements apply to the modified work as a whole. If identifiable sections of that work are not derived from the Program, and can be reasonably considered independent and separate works in themselves, then this License, and its terms, do not apply to those sections when you distribute them as separate works. But when you distribute the same sections as part of a whole which is a work based on the Program, the distribution of the whole must be on the terms of this License, whose permissions for other licensees extend to the entire whole, and thus to each and every part regardless of who wrote it.

Thus, it is not the intent of this section to claim rights or contest your rights to work written entirely by you; rather, the intent is to exercise the right to control the distribution of derivative or collective works based on the Program.

In addition, mere aggregation of another work not based on the Program with the Program (or with a work based on the Program) on a volume of a storage or distribution medium does not bring the other work under the scope of this License.

3. You may copy and distribute the Program (or a work based on it, under Section 2) in object code or executable form under the terms of Sections 1 and 2 above provided that you also do one of the following:

a) Accompany it with the complete corresponding machine-readable source code, which must be distributed under the terms of Sections 1 and 2 above on a medium customarily used for software interchange; or,

b) Accompany it with a written offer, valid for at least three years, to give any third party, for a charge no more than your cost of physically performing source distribution, a complete machine-readable copy of the corresponding source code, to be distributed under the terms of Sections 1 and 2 above on a medium customarily used for software interchange; or,

c) Accompany it with the information you received as to the offer to distribute corresponding source code. [This alternative is allowed only for noncommercial distribution and only if you received the program in object code or executable form with such an offer, in accord with Subsection b above.]

The source code for a work means the preferred form of the work for making modifications to it. For an executable work, complete source code means all the source code for all modules it contains, plus any associated interface definition files, plus the scripts used to control compilation and installation of the executable. However, as a special exception, the source code distributed need not include anything that is normally distributed (in either source or binary form) with the major components (compiler, kernel, and so on) of the operating system on which the executable runs, unless that component itself accompanies the executable.

If distribution of executable or object code is made by offering access to copy from a designated place, then offering equivalent access to copy the source code from the same place counts as distribution of the source code, even though third parties are not compelled to copy the source along with the object code.

4. You may not copy, modify, sublicense, or distribute the Program except as expressly provided under this License. Any attempt otherwise to copy, modify, sublicense or distribute the Program is void, and will automatically terminate your rights under this License. However, parties who have received copies, or rights, from you under this License will not have their licenses terminated so long as such parties remain in full compliance.

5. You are not required to accept this License, since you have not signed it. However, nothing else grants you permission to modify or distribute the Program or its derivative works. These actions are prohibited by law if you do not accept this License. Therefore, by modifying or distributing the Program (or any work based on the Program), you indicate your acceptance of this License to do so, and all its terms and conditions for copying, distributing or modifying the Program or works based on it.

6. Each time you redistribute the Program (or any work based on the Program), the recipient automatically receives a license from the original licensor to copy, distribute or modify the Program subject to these terms and conditions. You may not impose any further restrictions on the recipients' exercise of the rights granted herein. You are not responsible for enforcing compliance by third parties to this License.

7. If, as a consequence of a court judgment or allegation of patent infringement or for any other reason (not limited to patent issues), conditions are imposed on you (whether by court order, agreement or otherwise) that contradict the conditions of this License, they do not excuse you from the conditions of this License. If you cannot distribute so as to satisfy simultaneously your obligations under this License and any other pertinent obligations, then as a consequence you may not distribute the Program at all. For example, if a patent license would not permit royalty-free redistribution of the Program by all those who receive copies directly or indirectly through you, then the only way you could satisfy both it and this License would be to refrain entirely from distribution of the Program.

If any portion of this section is held invalid or unenforceable under any particular circumstance, the balance of the section is intended to apply and the section as a whole is intended to apply in other circumstances.

It is not the purpose of this section to induce you to infringe any patents or other property right claims or to contest validity of any such claims; this section has the sole purpose of protecting the integrity of the free software distribution system, which is implemented by public license practices. Many people have made generous contributions to the wide range of software distributed through that system in reliance on consistent application of that system; it is up to the author/donor to decide if he or she is willing to distribute software through any other system and a licensee cannot impose that choice.

This section is intended to make thoroughly clear what is believed to be a consequence of the rest of this License.

8. If the distribution and/or use of the Program is restricted in certain countries either by patents or by copyrighted interfaces, the original copyright holder who places the Program under this License may add an explicit geographical distribution limitation excluding those countries, so that distribution is permitted only in or among countries not thus excluded. In such case, this License incorporates the limitation as if written in the body of this License.

9. The Free Software Foundation may publish revised and/or new versions of the General Public License from time to time. Such new versions will be similar in spirit to the present version, but may differ in detail to address new problems or concerns.

Each version is given a distinguishing version number. If the Program specifies a version number of this License which applies to it and "any later version", you have the option of following the terms and conditions either of that version or of any later version published by the Free Software Foundation. If the Program does not specify a version number of this License, you may choose any version ever published by the Free Software Foundation.

10. If you wish to incorporate parts of the Program into other free programs whose distribution conditions are different, write to the author to ask for permission. For software which is copyrighted by the Free Software Foundation, write to the Free Software Foundation; we sometimes make exceptions for this. Our decision will be guided by the two goals of preserving the free status of all derivatives of our free software and of promoting the sharing and reuse of software generally.

NO WARRANTY

11. BECAUSE THE PROGRAM IS LICENSED FREE OF CHARGE, THERE IS NO WARRANTY FOR THE PROGRAM, TO THE EXTENT PERMITTED BY APPLICABLE LAW. EXCEPT WHEN OTHERWISE STATED IN WRITING THE COPYRIGHT HOLDERS AND/OR OTHER PARTIES PROVIDE THE PROGRAM "AS IS" WITHOUT WARRANTY OF ANY KIND, EITHER EXPRESSED OR IMPLIED, INCLUDING, BUT NOT LIMITED TO, THE IMPLIED WARRANTIES OF MERCHANTABILITY AND FITNESS FOR A PARTICULAR PURPOSE. THE ENTIRE RISK AS TO THE QUALITY AND PERFORMANCE OF THE PROGRAM IS WITH YOU. SHOULD THE PROGRAM PROVE DEFECTIVE, YOU ASSUME THE COST OF ALL NECESSARY SERVICING, REPAIR OR CORRECTION.

12. IN NO EVENT UNLESS REQUIRED BY APPLICABLE LAW OR AGREED TO IN WRITING WILL ANY COPYRIGHT HOLDER, OR ANY OTHER PARTY WHO MAY MODIFY AND/OR REDISTRIBUTE THE PROGRAM AS PERMITTED ABOVE, BE LIABLE TO YOU FOR DAMAGES, INCLUDING ANY GENERAL, SPECIAL, INCIDENTAL OR CONSEQUENTIAL DAMAGES ARISING OUT OF THE USE OR INABILITY TO USE THE PROGRAM (INCLUDING BUT NOT LIMITED TO LOSS OF DATA OR DATA BEING RENDERED INACCURATE OR LOSSES SUSTAINED BY YOU OR THIRD PARTIES OR A FAILURE OF THE PROGRAM TO OPERATE WITH ANY OTHER PROGRAMS), EVEN IF SUCH HOLDER OR OTHER PARTY HAS BEEN ADVISED OF THE POSSIBILITY OF SUCH DAMAGES.

END OF TERMS AND CONDITIONS

How to Apply These Terms to Your New Programs

If you develop a new program, and you want it to be of the greatest possible use to the public, the best way to achieve this is to make it free software which everyone can redistribute and change under these terms.

To do so, attach the following notices to the program. It is safest to attach them to the start of each source file to most effectively convey the exclusion of warranty; and each file should have at least the "copyright" line and a pointer to where the full notice is found.

one line to give the program's name and an idea of what it does.
Copyright (C) yyyy name of author

This program is free software; you can redistribute it and/or modify it under the terms of the GNU General Public License as published by the Free Software Foundation; either version 2 of the License, or (at your option) any later version.

This program is distributed in the hope that it will be useful, but WITHOUT ANY WARRANTY; without even the implied warranty of MERCHANTABILITY or FITNESS FOR A PARTICULAR PURPOSE. See the GNU General Public License for more details.

You should have received a copy of the GNU General Public License along with this program; if not, write to the Free Software Foundation, Inc., 51 Franklin Street, Fifth Floor, Boston, MA 02110-1301, USA.

Also add information on how to contact you by electronic and paper mail.

If the program is interactive, make it output a short notice like this when it starts in an interactive mode:

Gnomovision version 69, Copyright (C) year name of author
Gnomovision comes with ABSOLUTELY NO WARRANTY; for details type `show w'. This is free software, and you are welcome to redistribute it under certain conditions; type `show c' for details.

The hypothetical commands `show w` and `show c` should show the appropriate parts of the General Public License. Of course, the commands you use may be called something other than `show w` and `show c`; they could even be mouse-clicks or menu items--whatever suits your program.

You should also get your employer (if you work as a programmer) or your school, if any, to sign a "copyright disclaimer" for the program, if necessary. Here is a sample; alter the names:

Yoyodyne, Inc., hereby disclaims all copyright interest in the program `Gnomovision' [which makes passes at compilers] written by James Hacker.

signature of Ty Coon, 1 April 1989
Ty Coon, President of Vice

This General Public License does not permit incorporating your program into proprietary programs. If your program is a subroutine library, you may consider it more useful to permit linking proprietary applications with the library. If this is what you want to do, use the [GNU Lesser General Public License](#) instead of this License.

GNU GENERAL PUBLIC LICENSE

Version 3, 29 June 2007

Copyright © 2007 Free Software Foundation, Inc. <<http://fsf.org/>>

Everyone is permitted to copy and distribute verbatim copies of this license document, but changing it is not allowed.

Preamble

The GNU General Public License is a free, copyleft license for software and other kinds of works.

The licenses for most software and other practical works are designed to take away your freedom to share and change the works. By contrast, the GNU General Public License is intended to guarantee your freedom to share and change all versions of a program--to make sure it remains free software for all its users. We, the Free Software Foundation, use the GNU General Public License for most of our software; it applies also to any other work released this way by its authors. You can apply it to your programs, too.

When we speak of free software, we are referring to freedom, not price. Our General Public Licenses are designed to make sure that you have the freedom to distribute copies of free software (and charge for them if you wish), that you receive source code or can get it if you want it, that you can change the software or use pieces of it in new free programs, and that you know you can do these things.

To protect your rights, we need to prevent others from denying you these rights or asking you to surrender the rights. Therefore, you have certain responsibilities if you distribute copies of the software, or if you modify it: responsibilities to respect the freedom of others.

For example, if you distribute copies of such a program, whether gratis or for a fee, you must pass on to the recipients the same freedoms that you received. You must make sure that they, too, receive or can get the source code. And you must show them these terms so they know their rights.

Developers that use the GNU GPL protect your rights with two steps: (1) assert copyright on the software, and (2) offer you this License giving you legal permission to copy, distribute and/or modify it.

For the developers' and authors' protection, the GPL clearly explains that there is no warranty for this free software. For both users' and authors' sake, the GPL requires that modified versions be marked as changed, so that their problems will not be attributed erroneously to authors of previous versions.

Some devices are designed to deny users access to install or run modified versions of the software inside them, although the manufacturer can do so. This is fundamentally incompatible with the aim of protecting users' freedom to change the software. The systematic pattern of such abuse occurs in the area of products for individuals to use, which is precisely where it is most unacceptable. Therefore, we have designed this version of the GPL to prohibit the practice for those products. If such problems arise substantially in other domains, we stand ready to extend this provision to those domains in future versions of the GPL, as needed to protect the freedom of users.

Finally, every program is threatened constantly by software patents. States should not allow patents to restrict development and use of software on general-purpose computers, but in those that do, we wish to avoid the special danger that patents applied to a free program could make it effectively proprietary. To prevent this, the GPL assures that patents cannot be used to render the program non-free.

The precise terms and conditions for copying, distribution and modification follow.

TERMS AND CONDITIONS

0. Definitions.

"This License" refers to version 3 of the GNU General Public License.

"Copyright" also means copyright-like laws that apply to other kinds of works, such as semiconductor masks.

"The Program" refers to any copyrightable work licensed under this License. Each licensee is addressed as "you". "Licensees" and "recipients" may be individuals or organizations.

To "modify" a work means to copy from or adapt all or part of the work in a fashion requiring copyright permission, other than the making of an exact copy. The resulting work is called a "modified version" of the earlier work or a work "based on" the earlier work.

A "covered work" means either the unmodified Program or a work based on the Program.

To "propagate" a work means to do anything with it that, without permission, would make you directly or secondarily liable for infringement under applicable copyright law, except executing it on a computer or modifying a private copy. Propagation includes copying, distribution (with or without modification), making available to the public, and in some countries other activities as well.

To "convey" a work means any kind of propagation that enables other parties to make or receive copies. Mere interaction with a user through a computer network, with no transfer of a copy, is not conveying.

An interactive user interface displays "Appropriate Legal Notices" to the extent that it includes a convenient and prominently visible feature that (1) displays an appropriate copyright notice, and (2) tells the user that there is no warranty for the work (except to the extent that warranties are provided), that licensees may convey the work under this License, and how to view a copy of this License. If the interface presents a list of user commands or options, such as a menu, a prominent item in the list meets this criterion.

1. Source Code.

The "source code" for a work means the preferred form of the work for making modifications to it. "Object code" means any non-source form of a work.

A "Standard Interface" means an interface that either is an official standard defined by a recognized standards body, or, in the case of interfaces specified for a particular programming language, one that is widely used among developers working in that language.

The "System Libraries" of an executable work include anything, other than the work as a whole, that (a) is included in the normal form of packaging a Major Component, but which is not part of that Major Component, and (b) serves only to enable use of the work with that Major Component, or to implement a Standard Interface for which an implementation is available to the public in source code form. A "Major Component", in this context, means a major essential component (kernel, window system, and so on) of the specific operating system (if any) on which the executable work runs, or a compiler used to produce the work, or an object code interpreter used to run it.

The "Corresponding Source" for a work in object code form means all the source code needed to generate, install, and (for an executable work) run the object code and to modify the work, including scripts to control those activities. However, it does not include the work's System Libraries, or general-purpose tools or generally available free programs which are used unmodified in performing those activities but which are not part of the work. For example, Corresponding Source includes interface definition files associated with source files for the work, and the source code for shared libraries and dynamically linked subprograms that the work is specifically designed to require, such as by intimate data communication or control flow between those subprograms and other parts of the work.

The Corresponding Source need not include anything that users can regenerate automatically from other parts of the Corresponding Source.

The Corresponding Source for a work in source code form is that same work.

2. Basic Permissions.

All rights granted under this License are granted for the term of copyright on the Program, and are irrevocable provided the stated conditions are met. This License explicitly affirms your unlimited permission to run the unmodified Program. The output from running a covered work is covered by this License only if the output, given its content, constitutes a covered work. This License acknowledges your rights of fair use or other equivalent, as provided by copyright law.

You may make, run and propagate covered works that you do not convey, without conditions so long as your license otherwise remains in force. You may convey covered works to others for the sole purpose of having them make modifications exclusively for you, or provide you with facilities for running those works, provided that you comply with the terms of this License in conveying all material for which you do not control copyright. Those thus making or running the covered works for you must do so exclusively on your behalf, under your direction and control, on terms that prohibit them from making any copies of your copyrighted material outside their relationship with you.

Conveying under any other circumstances is permitted solely under the conditions stated below. Sublicensing is not allowed; section 10 makes it unnecessary.

3. Protecting Users' Legal Rights From Anti-Circumvention Law.

No covered work shall be deemed part of an effective technological measure under any applicable law fulfilling obligations under article 11 of the WIPO copyright treaty adopted on 20 December 1996, or similar laws prohibiting or restricting circumvention of such measures.

When you convey a covered work, you waive any legal power to forbid circumvention of technological measures to the extent such circumvention is effected by exercising rights under this License with respect to the covered work, and you disclaim any intention to limit operation or modification of the work as a means of enforcing, against the work's users, your or third parties' legal rights to forbid circumvention of technological measures.

4. Conveying Verbatim Copies.

You may convey verbatim copies of the Program's source code as you receive it, in any medium, provided that you conspicuously and appropriately publish on each copy an appropriate copyright notice; keep intact all notices stating that this License and any non-permissive terms added in accord with section 7 apply to the code; keep intact all notices of the absence of any warranty; and give all recipients a copy of this License along with the Program.

You may charge any price or no price for each copy that you convey, and you may offer support or warranty protection for a fee.

5. Conveying Modified Source Versions.

You may convey a work based on the Program, or the modifications to produce it from the Program, in the form of source code under the terms of section 4, provided that you also meet all of these conditions:

- a) The work must carry prominent notices stating that you modified it, and giving a relevant date.
- b) The work must carry prominent notices stating that it is released under this License and any conditions added under section 7. This requirement modifies the requirement in section 4 to "keep intact all notices".
- c) You must license the entire work, as a whole, under this License to anyone who comes into possession of a copy. This License will therefore apply, along with any applicable section 7 additional terms, to the whole of the work, and all its parts, regardless of how they are packaged. This License gives no permission to license the work in any other way, but it does not invalidate such permission if you have separately received it.
- d) If the work has interactive user interfaces, each must display Appropriate Legal Notices; however, if the Program has interactive interfaces that do not display Appropriate Legal Notices, your work need not make them do so.

A compilation of a covered work with other separate and independent works, which are not by their nature extensions of the covered work, and which are not

combined with it such as to form a larger program, in or on a volume of a storage or distribution medium, is called an "aggregate" if the compilation and its resulting copyright are not used to limit the access or legal rights of the compilation's users beyond what the individual works permit. Inclusion of a covered work in an aggregate does not cause this License to apply to the other parts of the aggregate.

6. Conveying Non-Source Forms.

You may convey a covered work in object code form under the terms of sections 4 and 5, provided that you also convey the machine-readable Corresponding Source under the terms of this License, in one of these ways:

- a) Convey the object code in, or embodied in, a physical product (including a physical distribution medium), accompanied by the Corresponding Source fixed on a durable physical medium customarily used for software interchange.
- b) Convey the object code in, or embodied in, a physical product (including a physical distribution medium), accompanied by a written offer, valid for at least three years and valid for as long as you offer spare parts or customer support for that product model, to give anyone who possesses the object code either (1) a copy of the Corresponding Source for all the software in the product that is covered by this License, on a durable physical medium customarily used for software interchange, for a price no more than your reasonable cost of physically performing this conveying of source, or (2) access to copy the Corresponding Source from a network server at no charge.
- c) Convey individual copies of the object code with a copy of the written offer to provide the Corresponding Source. This alternative is allowed only occasionally and noncommercially, and only if you received the object code with such an offer, in accord with subsection 6b.
- d) Convey the object code by offering access from a designated place (gratis or for a charge), and offer equivalent access to the Corresponding Source in the same way through the same place at no further charge. You need not require recipients to copy the Corresponding Source along with the object code. If the place to copy the object code is a network server, the Corresponding Source may be on a different server (operated by you or a third party) that supports equivalent copying facilities, provided you maintain clear directions next to the object code saying where to find the Corresponding Source. Regardless of what server hosts the Corresponding Source, you remain obligated to ensure that it is available for as long as needed to satisfy these requirements.
- e) Convey the object code using peer-to-peer transmission, provided you inform other peers where the object code and Corresponding Source of the work are being offered to the general public at no charge under subsection 6d.

A separable portion of the object code, whose source code is excluded from the Corresponding Source as a System Library, need not be included in conveying the object code work.

A "User Product" is either (1) a "consumer product", which means any tangible personal property which is normally used for personal, family, or household purposes, or (2) anything designed or sold for incorporation into a dwelling. In determining whether a product is a consumer product, doubtful cases shall be resolved in favor of coverage. For a particular product received by a particular user, "normally used" refers to a typical or common use of that class of product, regardless of the status of the particular user or of the way in which the particular user actually uses, or expects or is expected to use, the product. A product is a consumer product regardless of whether the product has substantial commercial, industrial or non-consumer uses, unless such uses represent the only significant mode of use of the product.

"Installation Information" for a User Product means any methods, procedures, authorization keys, or other information required to install and execute modified versions of a covered work in that User Product from a modified version of its Corresponding Source. The information must suffice to ensure that the continued functioning of the modified object code is in no case prevented or interfered with solely because modification has been made.

If you convey an object code work under this section in, or with, or specifically for use in, a User Product, and the conveying occurs as part of a transaction in which the right of possession and use of the User Product is transferred to the recipient in perpetuity or for a fixed term (regardless of how the transaction is characterized), the Corresponding Source conveyed under this section must be accompanied by the Installation Information. But this requirement does not apply if neither you nor any third party retains the ability to install modified object code on the User Product (for example, the work has been installed in ROM).

The requirement to provide Installation Information does not include a requirement to continue to provide support service, warranty, or updates for a work that has been modified or installed by the recipient, or for the User Product in which it has been modified or installed. Access to a network may be denied

when the modification itself materially and adversely affects the operation of the network or violates the rules and protocols for communication across the network.

Corresponding Source conveyed, and Installation Information provided, in accord with this section must be in a format that is publicly documented (and with an implementation available to the public in source code form), and must require no special password or key for unpacking, reading or copying.

7. Additional Terms.

"Additional permissions" are terms that supplement the terms of this License by making exceptions from one or more of its conditions. Additional permissions that are applicable to the entire Program shall be treated as though they were included in this License, to the extent that they are valid under applicable law. If additional permissions apply only to part of the Program, that part may be used separately under those permissions, but the entire Program remains governed by this License without regard to the additional permissions.

When you convey a copy of a covered work, you may at your option remove any additional permissions from that copy, or from any part of it. (Additional permissions may be written to require their own removal in certain cases when you modify the work.) You may place additional permissions on material, added by you to a covered work, for which you have or can give appropriate copyright permission.

Notwithstanding any other provision of this License, for material you add to a covered work, you may (if authorized by the copyright holders of that material) supplement the terms of this License with terms:

- a) Disclaiming warranty or limiting liability differently from the terms of sections 15 and 16 of this License; or
- b) Requiring preservation of specified reasonable legal notices or author attributions in that material or in the Appropriate Legal Notices displayed by works containing it; or
- c) Prohibiting misrepresentation of the origin of that material, or requiring that modified versions of such material be marked in reasonable ways as different from the original version; or
- d) Limiting the use for publicity purposes of names of licensors or authors of the material; or
- e) Declining to grant rights under trademark law for use of some trade names, trademarks, or service marks; or
- f) Requiring indemnification of licensors and authors of that material by anyone who conveys the material (or modified versions of it) with contractual assumptions of liability to the recipient, for any liability that these contractual assumptions directly impose on those licensors and authors.

All other non-permissive additional terms are considered "further restrictions" within the meaning of section 10. If the Program as you received it, or any part of it, contains a notice stating that it is governed by this License along with a term that is a further restriction, you may remove that term. If a license document contains a further restriction but permits relicensing or conveying under this License, you may add to a covered work material governed by the terms of that license document, provided that the further restriction does not survive such relicensing or conveying.

If you add terms to a covered work in accord with this section, you must place, in the relevant source files, a statement of the additional terms that apply to those files, or a notice indicating where to find the applicable terms.

Additional terms, permissive or non-permissive, may be stated in the form of a separately written license, or stated as exceptions; the above requirements apply either way.

8. Termination.

You may not propagate or modify a covered work except as expressly provided under this License. Any attempt otherwise to propagate or modify it is void, and will automatically terminate your rights under this License (including any patent licenses granted under the third paragraph of section 11).

However, if you cease all violation of this License, then your license from a particular copyright holder is reinstated (a) provisionally, unless and until the copyright holder explicitly and finally terminates your license, and (b) permanently, if the copyright holder fails to notify you of the violation by some reasonable means prior to 60 days after the cessation.

Moreover, your license from a particular copyright holder is reinstated permanently if the copyright holder notifies you of the violation by some reasonable means, this is the first time you have received notice of violation of

this License (for any work) from that copyright holder, and you cure the violation prior to 30 days after your receipt of the notice.

Termination of your rights under this section does not terminate the licenses of parties who have received copies or rights from you under this License. If your rights have been terminated and not permanently reinstated, you do not qualify to receive new licenses for the same material under section 10.

9. Acceptance Not Required for Having Copies.

You are not required to accept this License in order to receive or run a copy of the Program. Ancillary propagation of a covered work occurring solely as a consequence of using peer-to-peer transmission to receive a copy likewise does not require acceptance. However, nothing other than this License grants you permission to propagate or modify any covered work. These actions infringe copyright if you do not accept this License. Therefore, by modifying or propagating a covered work, you indicate your acceptance of this License to do so.

10. Automatic Licensing of Downstream Recipients.

Each time you convey a covered work, the recipient automatically receives a license from the original licensors, to run, modify and propagate that work, subject to this License. You are not responsible for enforcing compliance by third parties with this License.

An "entity transaction" is a transaction transferring control of an organization, or substantially all assets of one, or subdividing an organization, or merging organizations. If propagation of a covered work results from an entity transaction, each party to that transaction who receives a copy of the work also receives whatever licenses to the work the party's predecessor in interest had or could give under the previous paragraph, plus a right to possession of the Corresponding Source of the work from the predecessor in interest, if the predecessor has it or can get it with reasonable efforts.

You may not impose any further restrictions on the exercise of the rights granted or affirmed under this License. For example, you may not impose a license fee, royalty, or other charge for exercise of rights granted under this License, and you may not initiate litigation (including a cross-claim or counterclaim in a lawsuit) alleging that any patent claim is infringed by making, using, selling, offering for sale, or importing the Program or any portion of it.

11. Patents.

A "contributor" is a copyright holder who authorizes use under this License of the Program or a work on which the Program is based. The work thus licensed is called the contributor's "contributor version".

A contributor's "essential patent claims" are all patent claims owned or controlled by the contributor, whether already acquired or hereafter acquired, that would be infringed by some manner, permitted by this License, of making, using, or selling its contributor version, but do not include claims that would be infringed only as a consequence of further modification of the contributor version. For purposes of this definition, "control" includes the right to grant patent sublicenses in a manner consistent with the requirements of this License.

Each contributor grants you a non-exclusive, worldwide, royalty-free patent license under the contributor's essential patent claims, to make, use, sell, offer for sale, import and otherwise run, modify and propagate the contents of its contributor version.

In the following three paragraphs, a "patent license" is any express agreement or commitment, however denominated, not to enforce a patent (such as an express permission to practice a patent or covenant not to sue for patent infringement). To "grant" such a patent license to a party means to make such an agreement or commitment not to enforce a patent against the party.

If you convey a covered work, knowingly relying on a patent license, and the Corresponding Source of the work is not available for anyone to copy, free of charge and under the terms of this License, through a publicly available network server or other readily accessible means, then you must either (1) cause the Corresponding Source to be so available, or (2) arrange to deprive yourself of the benefit of the patent license for this particular work, or (3) arrange, in a manner consistent with the requirements of this License, to extend the patent license to downstream recipients. "Knowingly relying" means you have actual knowledge that, but for the patent license, your conveying the covered work in a country, or your recipient's use of the covered work in a country, would infringe one or more identifiable patents in that country that you have reason to believe are valid.

If, pursuant to or in connection with a single transaction or arrangement, you convey, or propagate by procuring conveyance of, a covered work, and grant a patent license to some of the parties receiving the covered work authorizing them to use, propagate, modify or convey a specific copy of the covered work,

then the patent license you grant is automatically extended to all recipients of the covered work and works based on it.

A patent license is "discriminatory" if it does not include within the scope of its coverage, prohibits the exercise of, or is conditioned on the non-exercise of one or more of the rights that are specifically granted under this License. You may not convey a covered work if you are a party to an arrangement with a third party that is in the business of distributing software, under which you make payment to the third party based on the extent of your activity of conveying the work, and under which the third party grants, to any of the parties who would receive the covered work from you, a discriminatory patent license (a) in connection with copies of the covered work conveyed by you (or copies made from those copies), or (b) primarily for and in connection with specific products or compilations that contain the covered work, unless you entered into that arrangement, or that patent license was granted, prior to 28 March 2007.

Nothing in this License shall be construed as excluding or limiting any implied license or other defenses to infringement that may otherwise be available to you under applicable patent law.

12. No Surrender of Others' Freedom.

If conditions are imposed on you (whether by court order, agreement or otherwise) that contradict the conditions of this License, they do not excuse you from the conditions of this License. If you cannot convey a covered work so as to satisfy simultaneously your obligations under this License and any other pertinent obligations, then as a consequence you may not convey it at all. For example, if you agree to terms that obligate you to collect a royalty for further conveying from those to whom you convey the Program, the only way you could satisfy both those terms and this License would be to refrain entirely from conveying the Program.

13. Use with the GNU Affero General Public License.

Notwithstanding any other provision of this License, you have permission to link or combine any covered work with a work licensed under version 3 of the GNU Affero General Public License into a single combined work, and to convey the resulting work. The terms of this License will continue to apply to the part which is the covered work, but the special requirements of the GNU Affero General Public License, section 13, concerning interaction through a network will apply to the combination as such.

14. Revised Versions of this License.

The Free Software Foundation may publish revised and/or new versions of the GNU General Public License from time to time. Such new versions will be similar in spirit to the present version, but may differ in detail to address new problems or concerns.

Each version is given a distinguishing version number. If the Program specifies that a certain numbered version of the GNU General Public License "or any later version" applies to it, you have the option of following the terms and conditions either of that numbered version or of any later version published by the Free Software Foundation. If the Program does not specify a version number of the GNU General Public License, you may choose any version ever published by the Free Software Foundation.

If the Program specifies that a proxy can decide which future versions of the GNU General Public License can be used, that proxy's public statement of acceptance of a version permanently authorizes you to choose that version for the Program.

Later license versions may give you additional or different permissions. However, no additional obligations are imposed on any author or copyright holder as a result of your choosing to follow a later version.

15. Disclaimer of Warranty.

THERE IS NO WARRANTY FOR THE PROGRAM, TO THE EXTENT PERMITTED BY APPLICABLE LAW. EXCEPT WHEN OTHERWISE STATED IN WRITING THE COPYRIGHT HOLDERS AND/OR OTHER PARTIES PROVIDE THE PROGRAM "AS IS" WITHOUT WARRANTY OF ANY KIND, EITHER EXPRESSED OR IMPLIED, INCLUDING, BUT NOT LIMITED TO, THE IMPLIED WARRANTIES OF MERCHANTABILITY AND FITNESS FOR A PARTICULAR PURPOSE. THE ENTIRE RISK AS TO THE QUALITY AND PERFORMANCE OF THE PROGRAM IS WITH YOU. SHOULD THE PROGRAM PROVE DEFECTIVE, YOU ASSUME THE COST OF ALL NECESSARY SERVICING, REPAIR OR CORRECTION.

16. Limitation of Liability.

IN NO EVENT UNLESS REQUIRED BY APPLICABLE LAW OR AGREED TO IN WRITING WILL ANY COPYRIGHT HOLDER, OR ANY OTHER PARTY WHO MODIFIES AND/OR CONVEYS THE PROGRAM AS PERMITTED ABOVE, BE LIABLE

TO YOU FOR DAMAGES, INCLUDING ANY GENERAL, SPECIAL, INCIDENTAL OR CONSEQUENTIAL DAMAGES ARISING OUT OF THE USE OR INABILITY TO USE THE PROGRAM (INCLUDING BUT NOT LIMITED TO LOSS OF DATA OR DATA BEING RENDERED INACCURATE OR LOSSES SUSTAINED BY YOU OR THIRD PARTIES OR A FAILURE OF THE PROGRAM TO OPERATE WITH ANY OTHER PROGRAMS), EVEN IF SUCH HOLDER OR OTHER PARTY HAS BEEN ADVISED OF THE POSSIBILITY OF SUCH DAMAGES.

17. Interpretation of Sections 15 and 16.

If the disclaimer of warranty and limitation of liability provided above cannot be given local legal effect according to their terms, reviewing courts shall apply local law that most closely approximates an absolute waiver of all civil liability in connection with the Program, unless a warranty or assumption of liability accompanies a copy of the Program in return for a fee.

GNU LESSER GENERAL PUBLIC LICENSE

Version 2.1, February 1999

Copyright (C) 1991, 1999 Free Software Foundation, Inc.
51 Franklin Street, Fifth Floor, Boston, MA 02110-1301 USA
Everyone is permitted to copy and distribute verbatim copies of this license document, but changing it is not allowed.

[This is the first released version of the Lesser GPL. It also counts as the successor of the GNU Library Public License, version 2, hence the version number 2.1.]

Preamble

The licenses for most software are designed to take away your freedom to share and change it. By contrast, the GNU General Public Licenses are intended to guarantee your freedom to share and change free software--to make sure the software is free for all its users.

This license, the Lesser General Public License, applies to some specially designated software packages--typically libraries--of the Free Software Foundation and other authors who decide to use it. You can use it too, but we suggest you first think carefully about whether this license or the ordinary General Public License is the better strategy to use in any particular case, based on the explanations below.

When we speak of free software, we are referring to freedom of use, not price. Our General Public Licenses are designed to make sure that you have the freedom to distribute copies of free software (and charge for this service if you wish); that you receive source code or can get it if you want it; that you can change the software and use pieces of it in new free programs; and that you are informed that you can do these things.

To protect your rights, we need to make restrictions that forbid distributors to deny you these rights or to ask you to surrender these rights. These restrictions translate to certain responsibilities for you if you distribute copies of the library or if you modify it.

For example, if you distribute copies of the library, whether gratis or for a fee, you must give the recipients all the rights that we gave you. You must make sure that they, too, receive or can get the source code. If you link other code with the library, you must provide complete object files to the recipients, so that they can relink them with the library after making changes to the library and recompiling it. And you must show them these terms so they know their rights.

We protect your rights with a two-step method: (1) we copyright the library, and (2) we offer you this license, which gives you legal permission to copy, distribute and/or modify the library.

To protect each distributor, we want to make it very clear that there is no warranty for the free library. Also, if the library is modified by someone else and passed on, the recipients should know that what they have is not the original version, so that the original author's reputation will not be affected by problems that might be introduced by others.

Finally, software patents pose a constant threat to the existence of any free program. We wish to make sure that a company cannot effectively restrict the users of a free program by obtaining a restrictive license from a patent holder. Therefore, we insist that any patent license obtained for a version of the library must be consistent with the full freedom of use specified in this license.

Most GNU software, including some libraries, is covered by the ordinary GNU General Public License. This license, the GNU Lesser General Public License, applies to certain designated libraries, and is quite different from the ordinary General Public License. We use this license for certain libraries in order to permit linking those libraries into non-free programs.

When a program is linked with a library, whether statically or using a shared library, the combination of the two is legally speaking a combined work, a derivative of the original library. The ordinary General Public License therefore permits such linking only if the entire combination fits its criteria of freedom. The Lesser General Public License permits more lax criteria for linking other code with the library.

We call this license the "Lesser" General Public License because it does Less to protect the user's freedom than the ordinary General Public License. It also provides other free software developers Less of an advantage over competing non-free programs. These disadvantages are the reason we use the ordinary General Public License for many libraries. However, the Lesser license provides advantages in certain special circumstances.

For example, on rare occasions, there may be a special need to encourage the widest possible use of a certain library, so that it becomes a de-facto standard. To achieve this, non-free programs must be allowed to use the library. A more frequent case is that a free library does the same job as widely used non-free libraries. In this case, there is little to gain by limiting the free library to free software only, so we use the Lesser General Public License.

In other cases, permission to use a particular library in non-free programs enables a greater number of people to use a large body of free software. For example, permission to use the GNU C Library in non-free programs enables many more people to use the whole GNU operating system, as well as its variant, the GNU/Linux operating system.

Although the Lesser General Public License is Less protective of the users' freedom, it does ensure that the user of a program that is linked with the Library has the freedom and the wherewithal to run that program using a modified version of the Library.

The precise terms and conditions for copying, distribution and modification follow. Pay close attention to the difference between a "work based on the library" and a "work that uses the library". The former contains code derived from the library, whereas the latter must be combined with the library in order to run.

TERMS AND CONDITIONS FOR COPYING, DISTRIBUTION AND MODIFICATION

0. This License Agreement applies to any software library or other program which contains a notice placed by the copyright holder or other authorized party saying it may be distributed under the terms of this Lesser General Public License (also called "this License"). Each licensee is addressed as "you".

A "library" means a collection of software functions and/or data prepared so as to be conveniently linked with application programs (which use some of those functions and data) to form executables.

The "Library", below, refers to any such software library or work which has been distributed under these terms. A "work based on the Library" means either the Library or any derivative work under copyright law: that is to say, a work containing the Library or a portion of it, either verbatim or with modifications and/or translated straightforwardly into another language. (Hereinafter, translation is included without limitation in the term "modification".)

"Source code" for a work means the preferred form of the work for making modifications to it. For a library, complete source code means all the source code for all modules it contains, plus any associated interface definition files, plus the scripts used to control compilation and installation of the library.

Activities other than copying, distribution and modification are not covered by this License; they are outside its scope. The act of running a program using the Library is not restricted, and output from such a program is covered only if its contents constitute a work based on the Library (independent of the use of the Library in a tool for writing it). Whether that is true depends on what the Library does and what the program that uses the Library does.

1. You may copy and distribute verbatim copies of the Library's complete source code as you receive it, in any medium, provided that you conspicuously and appropriately publish on each copy an appropriate copyright notice and disclaimer of warranty; keep intact all the notices that refer to this License and to the absence of any warranty; and distribute a copy of this License along with the Library.

You may charge a fee for the physical act of transferring a copy, and you may at your option offer warranty protection in exchange for a fee.

2. You may modify your copy or copies of the Library or any portion of it, thus forming a work based on the Library, and copy and distribute such modifications or work under the terms of Section 1 above, provided that you also meet all of these conditions:

- **a)** The modified work must itself be a software library.
- **b)** You must cause the files modified to carry prominent notices stating that you changed the files and the date of any change.
- **c)** You must cause the whole of the work to be licensed at no charge to all third parties under the terms of this License.
- **d)** If a facility in the modified Library refers to a function or a table of data to be supplied by an application program that uses the facility, other than as an argument passed when the facility is invoked, then you must make a good faith effort to ensure that, in the event an application does not supply such function or table, the facility still operates, and performs whatever part of its purpose remains meaningful.

[For example, a function in a library to compute square roots has a purpose that is entirely well-defined independent of the application. Therefore, Subsection 2d requires that any application-supplied function or table used by this function must be optional: if the application does not supply it, the square root function must still compute square roots.]

These requirements apply to the modified work as a whole. If identifiable sections of that work are not derived from the Library, and can be reasonably considered independent and separate works in themselves, then this License, and its terms, do not apply to those sections when you distribute them as separate works. But when you distribute the same sections as part of a whole which is a work based on the Library, the distribution of the whole must be on the terms of this License, whose permissions for other licensees extend to the entire whole, and thus to each and every part regardless of who wrote it.

Thus, it is not the intent of this section to claim rights or contest your rights to work written entirely by you; rather, the intent is to exercise the right to control the distribution of derivative or collective works based on the Library.

In addition, mere aggregation of another work not based on the Library with the Library (or with a work based on the Library) on a volume of a storage or distribution medium does not bring the other work under the scope of this License.

3. You may opt to apply the terms of the ordinary GNU General Public License instead of this License to a given copy of the Library. To do this, you must alter all the notices that refer to this License, so that they refer to the ordinary GNU General Public License, version 2, instead of to this License. (If a newer version than version 2 of the ordinary GNU General Public License has appeared, then you can specify that version instead if you wish.) Do not make any other change in these notices.

Once this change is made in a given copy, it is irreversible for that copy, so the ordinary GNU General Public License applies to all subsequent copies and derivative works made from that copy.

This option is useful when you wish to copy part of the code of the Library into a program that is not a library.

4. You may copy and distribute the Library (or a portion or derivative of it, under Section 2) in object code or executable form under the terms of Sections 1 and 2 above provided that you accompany it with the complete corresponding machine-readable source code, which must be distributed under the terms of Sections 1 and 2 above on a medium customarily used for software interchange.

If distribution of object code is made by offering access to copy from a designated place, then offering equivalent access to copy the source code from the same place satisfies the requirement to distribute the source code, even though third parties are not compelled to copy the source along with the object code.

5. A program that contains no derivative of any portion of the Library, but is designed to work with the Library by being compiled or linked with it, is called a "work that uses the Library". Such a work, in isolation, is not a derivative work of the Library, and therefore falls outside the scope of this License.

However, linking a "work that uses the Library" with the Library creates an executable that is a derivative of the Library (because it contains portions of the Library), rather than a "work that uses the library". The executable is therefore covered by this License. Section 6 states terms for distribution of such executables.

When a "work that uses the Library" uses material from a header file that is part of the Library, the object code for the work may be a derivative work of the Library even though the source code is not. Whether this is true is especially significant if the work can be linked without the Library, or if the work is itself a library. The threshold for this to be true is not precisely defined by law.

If such an object file uses only numerical parameters, data structure layouts and accessors, and small macros and small inline functions (ten lines or less in length), then the use of the object file is unrestricted, regardless of whether it is legally a derivative work. (Executables containing this object code plus portions of the Library will still fall under Section 6.)

Otherwise, if the work is a derivative of the Library, you may distribute the object code for the work under the terms of Section 6. Any executables containing that work also fall under Section 6, whether or not they are linked directly with the Library itself.

6. As an exception to the Sections above, you may also combine or link a "work that uses the Library" with the Library to produce a work containing portions of the Library, and distribute that work under terms of your choice, provided that the terms permit modification of the work for the customer's own use and reverse engineering for debugging such modifications.

You must give prominent notice with each copy of the work that the Library is used in it and that the Library and its use are covered by this License. You must supply a copy of this License. If the work during execution displays copyright notices, you must include the copyright notice for the Library among them, as well as a reference directing the user to the copy of this License. Also, you must do one of these things:

- **a)** Accompany the work with the complete corresponding machine-readable source code for the Library including whatever changes were used in the work (which must be distributed under Sections 1 and 2 above); and, if the work is an executable linked with the Library, with the complete machine-readable "work that uses the Library", as object code and/or source code, so that the user can modify the Library and then relink to produce a modified executable containing the modified Library. (It is understood that the user who changes the contents of definitions files in the Library will not necessarily be able to recompile the application to use the modified definitions.)
- **b)** Use a suitable shared library mechanism for linking with the Library. A suitable mechanism is one that (1) uses at run time a copy of the library already present on the user's computer system, rather than copying library functions into the executable, and (2) will operate properly with a modified version of the library, if the user installs one, as long as the modified version is interface-compatible with the version that the work was made with.
- **c)** Accompany the work with a written offer, valid for at least three years, to give the same user the materials specified in Subsection 6a, above, for a charge no more than the cost of performing this distribution.
- **d)** If distribution of the work is made by offering access to copy from a designated place, offer equivalent access to copy the above specified materials from the same place.
- **e)** Verify that the user has already received a copy of these materials or that you have already sent this user a copy.

For an executable, the required form of the "work that uses the Library" must include any data and utility programs needed for reproducing the executable from it. However, as a special exception, the materials to be distributed need not include anything that is normally distributed (in either source or binary form) with the major components (compiler, kernel, and so on) of the operating system on which the executable runs, unless that component itself accompanies the executable.

It may happen that this requirement contradicts the license restrictions of other proprietary libraries that do not normally accompany the operating system. Such a contradiction means you cannot use both them and the Library together in an executable that you distribute.

7. You may place library facilities that are a work based on the Library side-by-side in a single library together with other library facilities not covered by this License, and distribute such a combined library, provided that the separate distribution of the work based on the Library and of the other library facilities is otherwise permitted, and provided that you do these two things:

- **a)** Accompany the combined library with a copy of the same work based on the Library, uncombined with any other library facilities. This must be distributed under the terms of the Sections above.
- **b)** Give prominent notice with the combined library of the fact that part of it is a work based on the Library, and explaining where to find the accompanying uncombined form of the same work.

8. You may not copy, modify, sublicense, link with, or distribute the Library except as expressly provided under this License. Any attempt otherwise to copy, modify, sublicense, link with, or distribute the Library is void, and will automatically terminate your rights under this License. However, parties who have received copies, or rights, from you under this License will not have their licenses terminated so long as such parties remain in full compliance.

9. You are not required to accept this License, since you have not signed it. However, nothing else grants you permission to modify or distribute the Library or its derivative works. These actions are prohibited by law if you do not accept this License. Therefore, by modifying or distributing the Library (or any work based on the Library), you indicate your acceptance of this License to do so, and all its terms and conditions for copying, distributing or modifying the Library or works based on it.

10. Each time you redistribute the Library (or any work based on the Library), the recipient automatically receives a license from the original licensor to copy, distribute, link with or modify the Library subject to these terms and conditions. You may not impose any further restrictions on the recipients' exercise of the rights granted herein. You are not responsible for enforcing compliance by third parties with this License.

11. If, as a consequence of a court judgment or allegation of patent infringement or for any other reason (not limited to patent issues), conditions are imposed on you (whether by court order, agreement or otherwise) that contradict the conditions of this License, they do not excuse you from the conditions of this License. If you cannot distribute so as to satisfy simultaneously your obligations under this License and any other pertinent obligations, then as a consequence you may not distribute the Library at all. For example, if a patent license would not permit royalty-free redistribution of the Library by all those who receive copies directly or indirectly through you, then the only way you could satisfy both it and this License would be to refrain entirely from distribution of the Library.

If any portion of this section is held invalid or unenforceable under any particular circumstance, the balance of the section is intended to apply, and the section as a whole is intended to apply in other circumstances.

It is not the purpose of this section to induce you to infringe any patents or other property right claims or to contest validity of any such claims; this section has the sole purpose of protecting the integrity of the free software distribution system which is implemented by public license practices. Many people have made generous contributions to the wide range of software distributed through that system in reliance on consistent application of that system; it is up to the author/donor to decide if he or she is willing to distribute software through any other system and a licensee cannot impose that choice.

This section is intended to make thoroughly clear what is believed to be a consequence of the rest of this License.

12. If the distribution and/or use of the Library is restricted in certain countries either by patents or by copyrighted interfaces, the original copyright holder who places the Library under this License may add an explicit geographical distribution limitation excluding those countries, so that distribution is permitted only in or among countries not thus excluded. In such case, this License incorporates the limitation as if written in the body of this License.

13. The Free Software Foundation may publish revised and/or new versions of the Lesser General Public License from time to time. Such new versions will be similar in spirit to the present version, but may differ in detail to address new problems or concerns.

Each version is given a distinguishing version number. If the Library specifies a version number of this License which applies to it and "any later version", you have the option of following the terms and conditions either of that version or of any later version published by the Free Software Foundation. If the Library does not specify a license version number, you may choose any version ever published by the Free Software Foundation.

14. If you wish to incorporate parts of the Library into other free programs whose distribution conditions are incompatible with these, write to the author to ask for permission. For software which is copyrighted by the Free Software Foundation, write to the Free Software Foundation; we sometimes make exceptions for this. Our decision will be guided by the two goals of preserving the free status of all derivatives of our free software and of promoting the sharing and reuse of software generally.

NO WARRANTY

15. BECAUSE THE LIBRARY IS LICENSED FREE OF CHARGE, THERE IS NO WARRANTY FOR THE LIBRARY, TO THE EXTENT PERMITTED BY APPLICABLE LAW. EXCEPT WHEN OTHERWISE STATED IN WRITING THE COPYRIGHT HOLDERS AND/OR OTHER PARTIES PROVIDE THE LIBRARY "AS IS" WITHOUT WARRANTY OF ANY KIND, EITHER EXPRESSED OR IMPLIED, INCLUDING, BUT NOT LIMITED TO, THE IMPLIED WARRANTIES OF MERCHANTABILITY AND FITNESS FOR A PARTICULAR PURPOSE. THE ENTIRE RISK AS TO THE QUALITY AND PERFORMANCE OF THE LIBRARY IS WITH YOU. SHOULD THE LIBRARY PROVE DEFECTIVE, YOU ASSUME THE COST OF ALL NECESSARY SERVICING, REPAIR OR CORRECTION.

16. IN NO EVENT UNLESS REQUIRED BY APPLICABLE LAW OR AGREED TO IN WRITING WILL ANY COPYRIGHT HOLDER, OR ANY OTHER PARTY WHO MAY MODIFY AND/OR REDISTRIBUTE THE LIBRARY AS PERMITTED ABOVE, BE LIABLE TO YOU FOR DAMAGES, INCLUDING ANY GENERAL, SPECIAL,

INCIDENTAL OR CONSEQUENTIAL DAMAGES ARISING OUT OF THE USE OR INABILITY TO USE THE LIBRARY (INCLUDING BUT NOT LIMITED TO LOSS OF DATA OR DATA BEING RENDERED INACCURATE OR LOSSES SUSTAINED BY YOU OR THIRD PARTIES OR A FAILURE OF THE LIBRARY TO OPERATE WITH ANY OTHER SOFTWARE), EVEN IF SUCH HOLDER OR OTHER PARTY HAS BEEN ADVISED OF THE POSSIBILITY OF SUCH DAMAGES.

END OF TERMS AND CONDITIONS

How to Apply These Terms to Your New Libraries

If you develop a new library, and you want it to be of the greatest possible use to the public, we recommend making it free software that everyone can redistribute and change. You can do so by permitting redistribution under these terms (or, alternatively, under the terms of the ordinary General Public License).

To apply these terms, attach the following notices to the library. It is safest to attach them to the start of each source file to most effectively convey the exclusion of warranty; and each file should have at least the "copyright" line and a pointer to where the full notice is found.

one line to give the library's name and an idea of what it does.
Copyright (C) year name of author

This library is free software; you can redistribute it and/or modify it under the terms of the GNU Lesser General Public License as published by the Free Software Foundation; either version 2.1 of the License, or (at your option) any later version.

This library is distributed in the hope that it will be useful, but WITHOUT ANY WARRANTY; without even the implied warranty of MERCHANTABILITY or FITNESS FOR A PARTICULAR PURPOSE. See the GNU Lesser General Public License for more details.

You should have received a copy of the GNU Lesser General Public License along with this library; if not, write to the Free Software Foundation, Inc., 51 Franklin Street, Fifth Floor, Boston, MA 02110-1301 USA

Also add information on how to contact you by electronic and paper mail.

You should also get your employer (if you work as a programmer) or your school, if any, to sign a "copyright disclaimer" for the library, if necessary. Here is a sample; alter the names:

Yoyodyne, Inc., hereby disclaims all copyright interest in the library 'Frob' (a library for tweaking knobs) written by James Random Hacker.

signature of Ty Coon, 1 April 1990
Ty Coon, President of Vice

OpenSSL License:

Copyright (c) 1998-2011 The OpenSSL Project. All rights reserved.

Redistribution and use in source and binary forms, with or without modification, are permitted provided that the following conditions are met:

1. Redistributions of source code must retain the above copyright notice, this list of conditions and the following disclaimer.
2. Redistributions in binary form must reproduce the above copyright notice, this list of conditions and the following disclaimer in the documentation and/or other materials provided with the distribution.
3. All advertising materials mentioning features or use of this software must display the following acknowledgment:
"This product includes software developed by the OpenSSL Project for use in the OpenSSL Toolkit. (<http://www.openssl.org/>)"
4. The names "OpenSSL Toolkit" and "OpenSSL Project" must not be used to endorse or promote products derived from this software without prior written permission. For written permission, please contact openssl-core@openssl.org.
5. Products derived from this software may not be called "OpenSSL" nor may "OpenSSL" appear in their names without prior written permission of the OpenSSL Project.
6. Redistributions of any form whatsoever must retain the following acknowledgment:
"This product includes software developed by the OpenSSL Project for use in the OpenSSL Toolkit (<http://www.openssl.org/>)"

THIS SOFTWARE IS PROVIDED BY THE OPENSSL PROJECT ``AS IS'' AND ANY EXPRESSED OR IMPLIED WARRANTIES, INCLUDING, BUT NOT LIMITED TO, THE IMPLIED WARRANTIES OF MERCHANTABILITY AND FITNESS FOR A PARTICULAR PURPOSE ARE DISCLAIMED. IN NO EVENT SHALL THE OPENSSL PROJECT OR ITS CONTRIBUTORS BE LIABLE FOR ANY DIRECT, INDIRECT, INCIDENTAL, SPECIAL, EXEMPLARY, OR CONSEQUENTIAL DAMAGES (INCLUDING, BUT NOT LIMITED TO, PROCUREMENT OF SUBSTITUTE GOODS OR SERVICES; LOSS OF USE, DATA, OR PROFITS; OR BUSINESS INTERRUPTION) HOWEVER CAUSED AND ON ANY THEORY OF LIABILITY, WHETHER IN

CONTRACT, STRICT LIABILITY, OR TORT (INCLUDING NEGLIGENCE OR OTHERWISE) ARISING IN ANY WAY OUT OF THE USE OF THIS SOFTWARE, EVEN IF ADVISED OF THE POSSIBILITY OF SUCH DAMAGE.

This product includes cryptographic software written by Eric Young (ey@cryptsoft.com). This product includes software written by Tim Hudson (tjh@cryptsoft.com).

Original SSLeay License

Copyright (C) 1995-1998 Eric Young (ey@cryptsoft.com)
All rights reserved.

This package is an SSL implementation written by Eric Young (ey@cryptsoft.com).
The implementation was written so as to conform with Netscapes SSL.

This library is free for commercial and non-commercial use as long as the following conditions are aheared to. The following conditions apply to all code found in this distribution, be it the RC4, RSA, lhash, DES, etc., code; not just the SSL code. The SSL documentation included with this distribution is covered by the same copyright terms except that the holder is Tim Hudson (tjh@cryptsoft.com).

Copyright remains Eric Young's, and as such any Copyright notices in the code are not to be removed.
If this package is used in a product, Eric Young should be given attribution as the author of the parts of the library used. This can be in the form of a textual message at program startup or in documentation (online or textual) provided with the package.

Redistribution and use in source and binary forms, with or without modification, are permitted provided that the following conditions are met:

1. Redistributions of source code must retain the copyright notice, this list of conditions and the following disclaimer.
2. Redistributions in binary form must reproduce the above copyright notice, this list of conditions and the following disclaimer in the documentation and/or other materials provided with the distribution.
3. All advertising materials mentioning features or use of this software must display the following acknowledgement:
"This product includes cryptographic software written by Eric Young (ey@cryptsoft.com)"
The word 'cryptographic' can be left out if the rouines from the library being used are not cryptographic related :-).
4. If you include any Windows specific code (or a derivative thereof) from the apps directory (application code) you must include an acknowledgement:
"This product includes software written by Tim Hudson (tjh@cryptsoft.com)"

THIS SOFTWARE IS PROVIDED BY ERIC YOUNG ``AS IS'' AND ANY EXPRESS OR IMPLIED WARRANTIES, INCLUDING, BUT NOT LIMITED TO, THE IMPLIED WARRANTIES OF MERCHANTABILITY AND FITNESS FOR A PARTICULAR PURPOSE ARE DISCLAIMED. IN NO EVENT SHALL THE AUTHOR OR CONTRIBUTORS BE LIABLE FOR ANY DIRECT, INDIRECT, INCIDENTAL, SPECIAL, EXEMPLARY, OR CONSEQUENTIAL DAMAGES (INCLUDING, BUT NOT LIMITED TO, PROCUREMENT OF SUBSTITUTE GOODS OR SERVICES; LOSS OF USE, DATA, OR PROFITS; OR BUSINESS INTERRUPTION) HOWEVER CAUSED AND ON ANY THEORY OF LIABILITY, WHETHER IN CONTRACT, STRICT LIABILITY, OR TORT (INCLUDING NEGLIGENCE OR OTHERWISE) ARISING IN ANY WAY OUT OF THE USE OF THIS SOFTWARE, EVEN IF ADVISED OF THE POSSIBILITY OF SUCH DAMAGE.

The licence and distribution terms for any publically available version or derivative of this code cannot be changed. i.e. this code cannot simply be copied and put under another distribution licence [including the GNU Public Licence.]