

FOR A GOOD **REASON** **GRUNDIG**

Owner's Manual



Cameras & Domes

GCA-B1322D	1/3" Col/B&W Fixed Dome Camera, Vari-Focal
GCA-B0322D	1/3" Col/B&W Fixed Dome Camera, Vari-Focal
GCA-B0323D	1/3" CCD Col/B&W Fixed Dome Camera w/ IR LED
GCA-B0325D	1/3" Col/B&W Fixed Dome Camera, Vari-Focal, WDR
GCA-B0326D	1/3" CCD Col/B&W Fixed Dome Camera w/ IR LED WDR

GCA-B1322D.1.1.25.11.2011

© ASP AG



Content:

1. Available Versions	1
2. Important Safety Instructions	2
3. Package Contents	2
4. Installation	3
1. Part Names	3
2. Base Installation	4
3. Connections	5
4. 3-Axis Gimbal Adjustment	6
5. Zoom & Focus Adjustment	6
5. OSD Menu	6
1. OSD Controls	6
2. Main menu	7
3. Camera Setup	8
4. Intelligence	15
5. Privacy Zone	17
6. Other Set	18
7. Communication	18
8. System Info	18
9. Language	19

1. Available Versions

These instructions apply to the following products. For the different properties of the products please refer to the table.

	GCA-B1322D	GCA-B0322D	GCA-B0323D	GCA-B0325D	GCA-B0326D
Day/Night	Soft	Soft	ICR	ICR	ICR
WDR	-	-	-	✓	✓
LED	-	-	✓	-	✓

2. Important Safety Instructions

Be sure to use only the standard adapter that is specified in the specification sheet. Using any other adapter could cause fire, electrical shock, or damage to the product. Incorrectly connecting the power supply or replacing battery may cause explosion, fire, electric shock, or damage to the product. Do not connect multiple products to one single adapter. Exceeding the capacity may cause abnormal heat generation or fire.

Do not place conductive objects (e.g. screwdrivers, coins or any metal items) or containers filled with water on top of the product. Doing so may cause personal injury due to fire, electric shock, or falling objects.

If any unusual smells or smoke comes from the unit, stop using the product. In such case, immediately disconnect the power source and contact the service center. Continued use in such a condition may cause fire or electric shock.

If this product fails to operate normally, contact the nearest service center. Never disassemble or modify this product in any way. (GRUNDIG is not liable for problems caused by unauthorised modifications or attempted repair.)

To prevent fire or electric shock, do not expose the inside of this device to rain or moisture.

3. Package Contents

These parts are included:

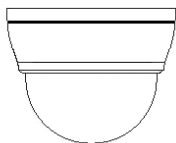

Camera



**Instruction
Manual**

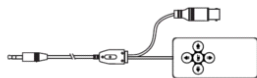

**Service Monitor and
Control Cable**



**Screws
(3 pcs)**

4. Installation

Do not install the product in a location subject to high temperature (over 50°C), low temperature (below -10°C), or high humidity. Doing so may cause fire or electric shock. Keep out of direct sunlight and heat radiation sources. This may cause fire. Avoid aiming the camera directly towards extremely bright objects such as the sun, as this may damage the image sensor.

Do not install the unit in humid, dusty or sooty locations. Doing so may cause fire or electric shock. Install it in a place with good ventilation.

When installing the unit, fasten it securely and firmly. A falling unit may cause personal injury.

If you want to relocate the already installed product, be sure to turn off the power and then move or reinstall it.

4.1. Part Names

1. Bubble
2. Dome Cover Ring
3. Mounting Screws
4. Camera Module Gimbal Bracket
5. Lens
6. Dome Base
7. Service Monitor Output Port
8. Video Out and Power Cable

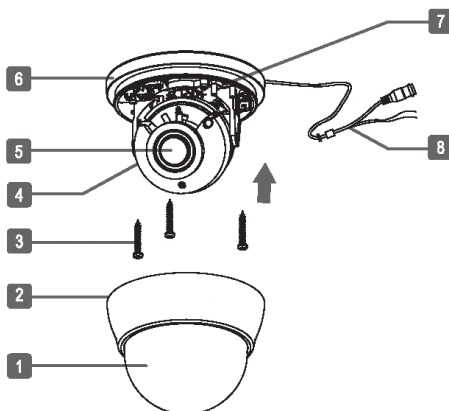

4.2. Base Installation

1. Open the dome cover ring at the marked position (e.g. with a flat screw driver).
2. There are three mounting holes on the Dome Base for installation of the unit in any place such as a ceiling, wall and etc. Use the three mounting screws to affix the Dome Base to a sturdy surface. To access all three holes, rotate the camera module.

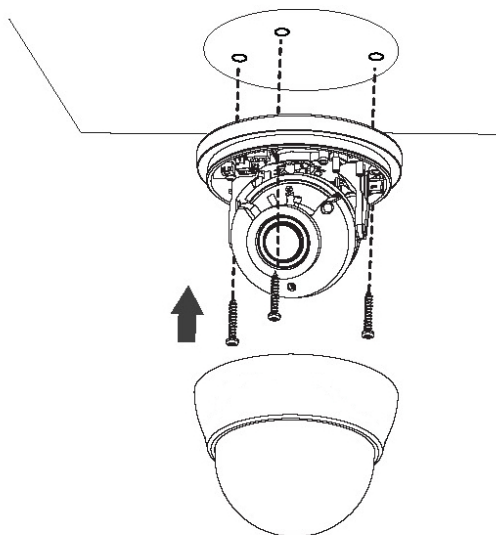

4.3. Connections

- Power connection: Requires a DC 12V or AC 24V input depending on the camera model.
- All camera models are supplied with a service monitor output on the camera module. A service monitor and control cable is included in the package.

Note:

To set up the OSD menu externally, a service monitor and control cable is required.

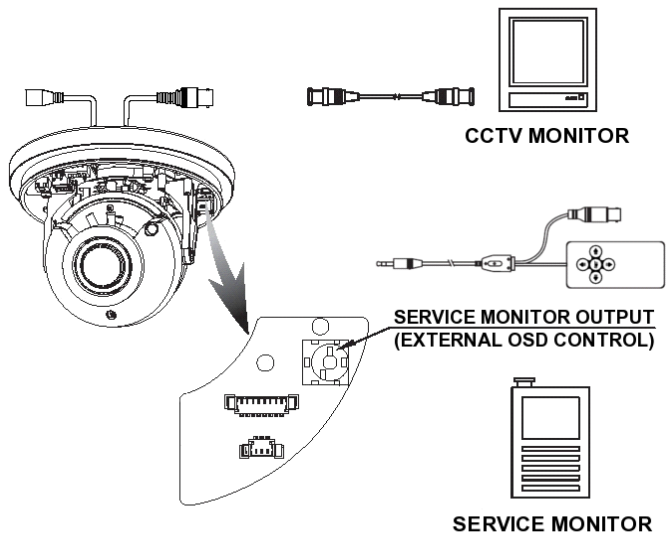

4.4. 3-Axis Gimbal Adjustment

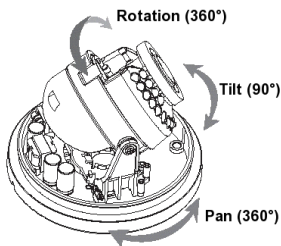

1. Pan: Adjust the pan by turning it manually to the right or left.
2. Tilt: Adjust the tilt by moving it manually up or down.
3. Rotation: Adjust the rotation manually to the desired angle.

4.5. Zoom & Focus Adjustment

1. If you need to make viewing angle/focus adjustments, move the levers as shown below. First loosen the Zoom/Focus levers, and then adjust them as needed.
2. After the adjustments are completed, tighten the Zoom/Focus levers.

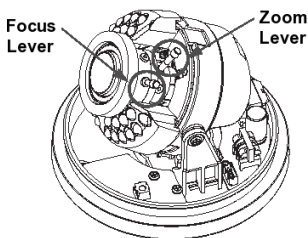
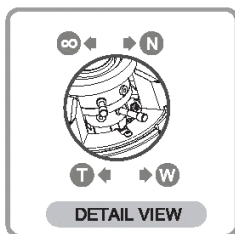

5. OSD Menu



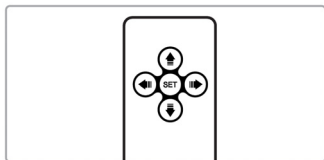

5.1. OSD Controls

5.1.1. OSD Control Keys



- SETUP key: Accesses the menu mode or confirms the setting.
- UP (Λ) / DOWN (V): Chooses the desired menu.
- LEFT (<) / RIGHT (>): Sets up the value of the selected menu.

5.1.2. OSD Icons

 [EXIT]	Exits the menu setting. Before you exit, make sure you SAVE your settings, or select QUIT to cancel.
 [RET]	Returns to the previous menu.
 [HOME]	Returns to the main menu.
 [SAVE]	Use this to SAVE your settings of MASK AREA, PRIVACY ZONE and more. Once you saved your settings, they will remain even if you select QUIT in the menu.
 [DEL]	Use this to delete your settings of MASK AREA, PRIVACY ZONE and more. Once you saved your settings, they will not be restored even if you select QUIT in the menu.

5.2. Main menu

1. Press the SETUP key and hold it for a while to access the menu mode.
2. Select the desired feature by using the UP/DOWN keys (\wedge \vee) on the control.

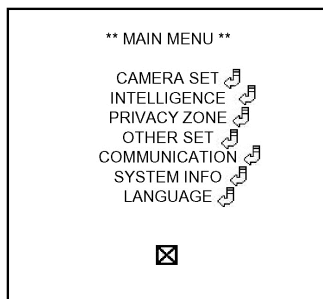

CAMERA SET: Here you can configure camera related functions and data.

INTELLIGENCE: You can configure the settings of motion detection, tracking and more.

PRIVACY ZONE: You can configure the privacy related settings.

OTHER SET: You can configure for factory defaults, and more.

COMMUNICATION: Configures the settings regarding the RS-485 communication.

SYSTEM INFO: Displays the system information including the camera version and communication settings.

LANGUAGE: Select a preferred language from those listed.

5.3. Camera Setup

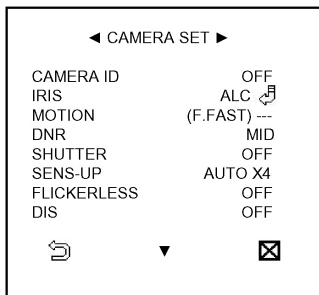

CAMERA ID [OFF, ON] :

It is used to switch on/off the camera id. If the camera id is switched ON, you can access the CAMERA ID menu to program the camera text.

IRIS [ALC, ELC] :

The IRIS menu is used if you want to adjust the intensity of light incoming into the camera.

MOTION [S.SLOW, SLOW, NORM, FAST, F.FAST] :

This menu is used to adjust the strength of the AGC level for a control of the camera motion. You can select from S.SLOW, SLOW, NORM, FAST and F.FAST for the AGC level. If you monitor fast moving objects in a low contrast scene, select F.FAST while selecting S.SLOW for hardly moving objects in the same lighting condition.

Note:

- This is only available if the SENS-UP menu is set to AUTO.

- If the DAY/NIGHT menu of CAMERA SET is set to AUTO, the MOTION menu will be deactivated.

DNR [OFF, LOW, MID, HIGH, USER (1~16)] :

You can configure the DNR (Digital Noise Reduction) related settings. It reduces the noise on the screen. This is especially useful for a severely distorted screen. You can set the level if you set DNR to USER.

SHUTTER [OFF, AUTO 1/120~1/10K, 1/120~1/10K] :

You can select one of 7 options from 1/120 to 1/10K for the fixed high speed electronic shutter, which is mostly used for imaging a fast moving object. The auto high speed electronic shutter operates as the fixed high speed shutter in a high contrast scene but automatically focuses the target if the iris opens fully in a low contrast scene like in ELC mode. When it gets bright again, the mode will switch to the fixed high speed electronic shutter mode. However, the auto high speed shutter operates properly only in a camera featuring a DC or VIDEO lens.

Note:

- If the IRIS menu is set to ELC, the SHUTTER menu will be deactivated as you adjust the brightness using the electronic shutter.
- If the SENS-UP menu is set to AUTO, only OFF and AUTO are available in the SHUTTER menu
- If the SENS-UP menu is set to FIX, the SHUTTER menu will be deactivated.
- If the FLICKERLESS function is set to ON, the SHUTTER menu will be deactivated.

SENS-UP [OFF, AUTO x2~x256, FIX x2~x256] :

Automatically detects the ambient level of darkness in a dark or low contrast scene to extend the accumulated time, keeping the image bright and sharp. It can also be used in FIX mode.

Note:

- If the SHUTTER menu is set to fixed electronic shutter mode, the SENS-UP menu will be deactivated.
- If the FLICKERLESS menu is set to ON, the FIX mode of the SENS-UP will be disabled.
- If the IRIS menu is set to ELC, the electronic shutter will control the brightness, so that the SENS-UP function cannot be set to FIX mode, but to OFF or AUTO mode.
- If the SHUTTER menu is set to AUTO, the SENS-UP menu can be set to either OFF or AUTO mode.

FLICKERLESS [OFF, ON] :

If set to ON, the shutter speed will be fixed to 1/120 seconds. This will prevent possible screen distortion due to a mismatch between the vertical sync frequency and the blinking frequency of the lighting.

Note:

- If the IRIS menu is set to ELC mode, the FLICKERLESS menu will be deactivated.
- If the SHUTTER menu is set to AUTO or FIX mode, the FLICKERLESS menu will be deactivated.
- If the SENS-UP menu is set to FIX mode, the FLICKERLESS menu will be deactivated.
- If the AGC menu is set to FIX mode, the FLICKERLESS function will be disabled.

DIS [OFF, ON] :

Digital Image Stabilisation will set the anti-shake compensation.

Note:

- If you set DIS to ON, the compensation area will be enlarged as set in the digital zoom factor.
- If you set the digital zoom factor to greater than the enlarged zoom factor for the compensation, the DIS function will be deactivated.

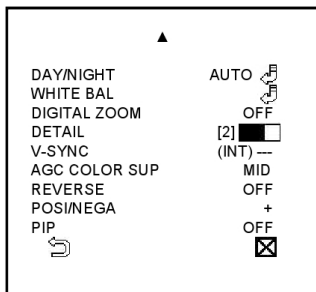

DAY & NIGHT [DAY, NIGHT, AUTO, EXT] :

- DAY: If set to DAY, it will be fixed to colour mode regardless of the ambient conditions.
- NIGHT: If set to NIGHT, it will be fixed to Black-and-White mode regardless of the ambient conditions. If you press the SETUP key, the NIGHT submenu is selected.
- AUTO: The camera will automatical switch between DAY and NIGHT mode, according to the lighting condition. If you press the SETUP key, the AUTO sub-menu is selected.

- EXT: This enables an auto switch between DAY and NIGHT mode using the brightness level detected by the inner photocell.

(The inner photocell is only available in GCA-B0323D, GCA-B0325D and GCA-B0326D.)

WHITE BAL :

If you want to adjust the colour scheme, use the WHITE BALANCE function.

DIGITAL ZOOM [ON, OFF] :

You can set the digital zoom factor and position. When the zoom factor and position are defined, the digital zoom function will operate.

DETAIL [0~3] :

Controls the horizontal or vertical distinction.

V-SYNC [INT] :

This camera model is set to fixed INT (Internal Synchronisation).

AGC COLOR SUP [LOW, MID, HIGH] :

Adjust the color scheme according to the AGC value.

REVERSE [OFF, H/V, H/V] :

Mirrors video signals horizontally, vertically, or both.

POSI/NEGA [+ , -] :

Output as it is or mirroring the video brightness signal.

PIP [OFF, ON] :

Displays a sub image together with the main image on the same screen using the Picture In Picture Function.

Note :

- If more than one privacy zone is set and the PRIVACY SET is set to ON, the PIP function will be deactivated.

5.3.1. CAMERA ID

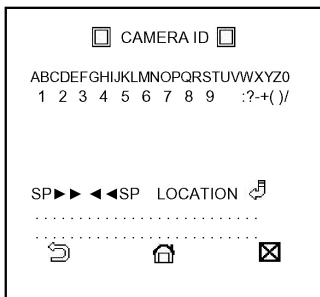

This menu is used to assign a unique name to a camera. You can enter up to 54 Alphanumeric or special characters for the CAMERA ID. Select LOCATION and press the SETUP key to move the display position of the CAMERA ID.

5.3.2. ALC (Automated Light Control)

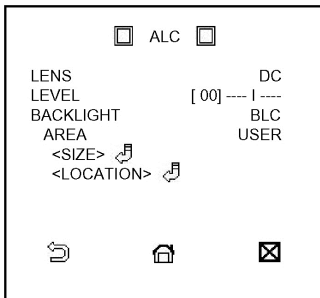

If you press the SETUP key with an ALC based submenu selected, you will see the LENS, LEVEL, BACKLIGHT options on your screen. In the LENS option, you must select DC for this camera model. In the LEVEL option, you can adjust the overall brightness where '+' will increase the brightness and '-' will decrease it.

In the BACKLIGHT option, you can adjust the BLC (Back Light Compensation) function. You can set the desired BLC zone by defining the size and the location. If you use the ordinary camera in a scene with an intensive back light, the object will be displayed dark on the monitor affected by the back light. To solve this problem, you can use the BLC function to improve the sharpness of the image in such a high contrast scene.

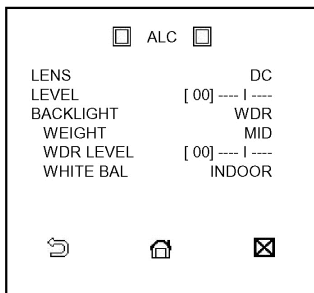

If you set the BACKLIGHT option to WDR*, you can adjust the shutter speed in WDR LEVEL and the brightness in WEIGHT. You can select either OUTDOOR or INDOOR in WHITE BAL. WDR (Wide Dynamic Range)* extends the gain range of the screen that is mostly useful if the camera is simultaneously looking at both indoor and outside i.e. viewing near a window or door entrance. It improves the sharpness of the picture of the outside view as well as indoor view. *WDR is only available for GCA-B0325D and GCA-B0326D.

5.3.3. ELC (Electronic Light Control)

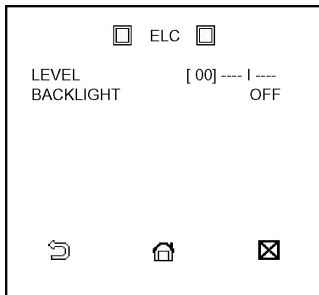

If you press the SETUP key when the ELC submenu is selected, the corresponding screen appears. You can set the ELC function to active or not. Similar to the ALC setting, you can specify the BLC area.

5.3.4. AGC USER

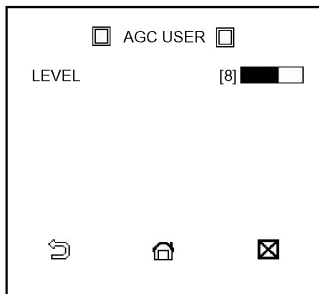

In this mode, you can break down the level in 16 steps from VERY LOW to VERY HIGH as you prefer.

5.3.5. AGC FIX

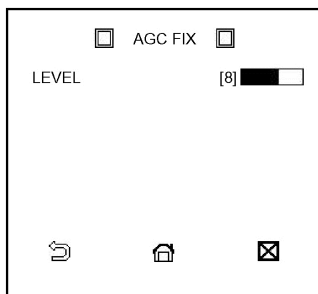

If you press the SETUP key with a FIX, you will see the appropriate screen. As a fixed value of the AGC gain is used in FIX mode, you can select one of the 16 detailed levels from VERY LOW to VERY HIGH before fixing it. FIX mode is not available if you set the BACKLIGHT function to WDR.

Note:

- If the DAY/NIGHT menu of CAMERA SET is set to AUTO, the AGC menu will be deactivated.

- If FLICKERLESS is set to ON, the AGC FIX mode will be disabled.

5.3.6. DAY/NIGHT (NIGHT MENU)

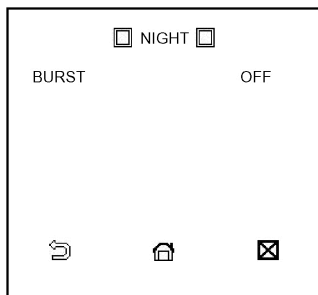

If set to NIGHT, it will be fixed to BLACK and WHITE mode regardless of the ambient conditions. If you press the SETUP key with a NIGHT submenu selected, you will see a menu where you can set BURST to OFF/ON. If BURST is set to ON, the Burst signal will output together with the BLACK and WHITE composite video signal. If BURST is set to OFF, the Burst signal does not output.

5.3.7. DAY/NIGHT (AUTO MENU)

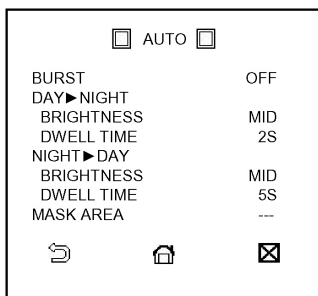

You can set the BURST option to OFF/ON, or select to output the Burst signal in NIGHT mode.

In the DAY > NIGHT option, you can select from LOW to HIGH for the brightness of DAY > NIGHT, which is a brightness level in switching from the colour filter to Black & White. Closing to LOW from HIGH will switch the filter in a low contrast scene. The DWELL TIME of DAY > NIGHT is a time required to determine the need for switching the filter.

In the NIGHT > DAY option, you can select from LOW to HIGH for the brightness of NIGHT > DAY, which is a brightness level in switching from the Black & White filter to colour. Closing to LOW from HIGH will switch the filter in a low contrast scene. The DWELL TIME of NIGHT > DAY is a time required to determine the need for switching the filter.

5.3.8. WHITE BALANCE

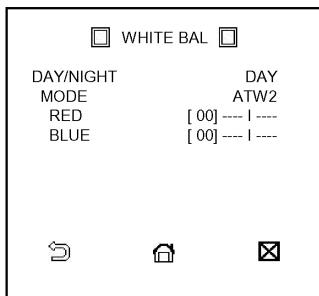

- DAY: In this mode, you can set the colour values of RED and BLUE. The screen will be displayed in colours according to your settings.

Note:

- You can set the values of R-GAIN and B-GAIN only in AWC mode.

- NIGHT: Use the NIGHT mode if you want to set the white balance differently according to the ambient Light. If the NIGHT mode is set to OFF, the white balance will always operate as set in DAY mode; if not set to OFF, the camera will switch as set in DAY/NIGHT mode according to the brightness. In NIGHT mode, you can set the values of RED, BLUE, and BRIGHTNESS. The screen will be displayed in colours according to your settings.

Note:

- You can set the values of R-GAIN and B-GAIN only in AWC mode.

- If AGC is set to OFF or FIX, you cannot access the NIGHT menu.

For adjusting the white balance, the following 5 modes are provided:

- ATW1 (Auto Tracing White Balance mode 1): The camera can automatically adjust the colour temperature in real time, according to the ambient conditions. The colour temperature ranges from approx. 2500K to 9500K.

- ATW2: The colour temperature ranges from approx. 1800K to 10500K.

- AWC (Auto White Balance Control): If you press the SETUP switch in the appropriate item position, Auto White Balance will be performed once.

- 3200K: Set colour temperature to 3200K.

- 5600K: Set colour temperature to 5600K.

RED: Adjusts the strength of the red colour.
 BLUE: Adjusts the strength of the blue colour.
 R-GAIN/B-GAIN: Enables you to set the current colour temperature manually.
 BRIGHTNESS: Selects a brightness level in switching from setting in DAY mode to setting in NIGHT mode.

5.3.9. DIGITAL ZOOM

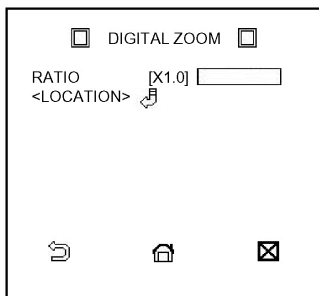

You can set the digital zoom factor and position. When the zoom factor and position are defined, the digital zoom function will operate.

- RATIO: Define the zoom factor with the direction keys (< >).
- LOCATION: If you press the SETUP key, you can change the position of the digital zoom with the direction keys (< ^ v >).

Note :

- The DIGITAL ZOOM function enlarges the pixel itself, which can cause deterioration of the image quality.

5.4. Intelligence

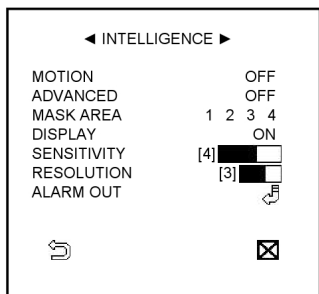

MOTION [OFF, TRACKING, DETECTION] :

TRACKING - Detects and tracks a moving object.

DETECTION - Detects a moving object.

Note :

- If this is set to DETECTION, you cannot set the function FIXED/MOVED in the ADVANCED menu.

ADVANCED* [OFF, MOVED/FIXED] :

If an object on the screen suddenly disappears or an object comes out from somewhere and stays for a certain time on the screen, this area will be displayed. A detection (MOVED/FIXED) error may occur if:

- Multiple motions occur continuously in random directions
- A fixed object moves in one position continuously
- A second object screens the first moving object

*This option is only available in the cameras with WDR function (GCA-B0325D and GCA-B0326D).

MASK AREA [1~4] :

Specify a detection exception area to mask.

DISPLAY [ON, OFF] :

With the DISPLAY option set to ON, a motion or a set ADVANCED function will be displayed on the screen, if detected.

SENSITIVITY [1~7] :

Set the sensitivity of the motion detection.

RESOLUTION [1~5] :

If you set the resolution to high, the camera can even detect movements of very small objects.

ALARM OUT :

**This function is not available in this camera version.

5.4.1. MASK AREA



Specify a detection exception area to mask.
Select a mask number and specify the size and position.

Note:

- If BACKLIGHT is set to BLC, the MASK AREA function will be deactivated.

5.5. Privacy Zone

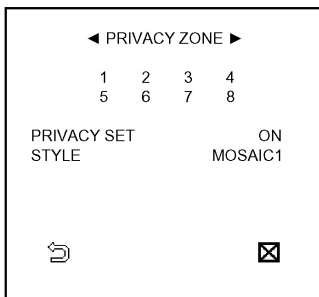

The PRIVACY ZONE function will protect your privacy by screening the privacy area that you have specified during monitoring. You can change the style to adjust the mosaic size and colour of the PRIVACY ZONE. Use the four direction keys to select the PRIVACY ZONE you require from 1~8 and press the SETUP key to confirm your setting.

Note:

- If more than one PRIVACY ZONE is specified and the PRIVACY SET is set to ON, the PIP function will be deactivated.

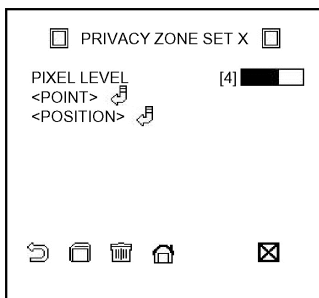

You can specify a pixel that moves as you change the PIXEL LEVEL to set the position.

How to set a point:

You can set each position of the 4 points.

- If you press the SETUP key in <POINT>, you will see the points available in the PRIVACY ZONE. Each time you press the SETUP key, the accessed point will change.
- Use the four direction keys to set the position of each point. Set each position of the four points and press the SETUP key to complete the positioning.

How to set a position:

You can move the position of the overall area.

- By pressing the SETUP key in <POSITION>, you can move the overall position of the privacy zone.
- Use the four direction keys to move the position and press the SETUP key to confirm it.

5.6. Other Set



FACTORY DEFAULTS :

All the settings will be restored to factory default. However, the settings of PROTOCOL, BAUD RATE, ADDRESS and LANGUAGE will not be restored to default.

OSD COLOR [BW, R/G/B] :

You can set the OSD (On Screen Display) colour to BW, RED, GREEN and BLUE.

5.7. Communication

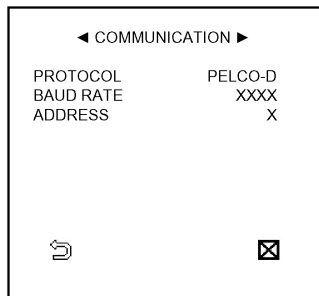

Configure the settings regarding the UART communication.

**This function is not available in this camera version.

5.8. System Info

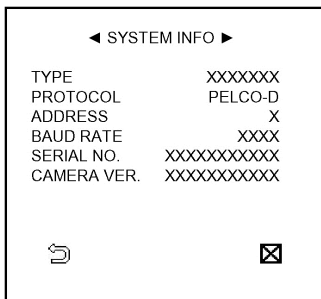

You can view the system information in this menu, including the type, protocol, address, baud rate, serial number, and camera version.

5.9. Language



The camera supports 5 different languages.
Select your preferred language from the list.

Specifications GCA-B1322D

Image Sensor	1/3" CCD (Sony Super HAD IT)
Resolution	600 (H) lines
Col/B&W	Auto (Electrical) / Color / B/W
Sensitivity	0.4 Lux(50IRE) @ F1.2, 0.001 Lux (15IRE, Sens up x256)
S/N Ratio	52 dB
Lens Drive Type	Auto iris, DC
Lens Focal Length	2.8 ~ 10.5 mm (TAMRON)
Sens Up	Off ~ x256, auto
Motion Detection	On/ Off/ Sensitivity/ Area setting
Number of Privacy Zones	8 (polygonal method)
High Speed Shutter	1/50 ~ 1/10.000 sec, auto
AGC	Off/ On (Very LOW/ LOW/ Mid /High /Very High/ User/ Fix)
BLC	On/ Off/ Area/ Level
Digital Zoom	Off/1 ~ 10x
Reverse	Off/ H-REV/ V-REV/ HV-REV/ POSITIV/ NEGATIV
PIP	On/Off
Intelligent Video Analytics	Tracking/Detection
Camera ID	54 character, 2 lines
White Balance	ATW-1/ATW-2/AWC/Manual
Remote Control	CCVC, data on coax cable
Video Outputs	1 CVBS 1 Vpp (BNC) & 1 test monitor out
Humidity	less than 90%
Operating Temperature	-10°C ~ +50°C
Supply Voltage	12 VDC/24 VAC
Power Consumption	1.7 W
Weight	0.32 kg
Dimensions (wxhxd)	Ø 122 x 95 mm

Specifications GCA-B0322D

Lens Focal Length	2.4 ~ 6 mm (TAMRON)
Power Consumption	1.7 W
Weight	0.32 kg
Dimensions (wxhxd)	Ø 122 x 95 mm

Specifications GCA-B0323D

Resolution	600(H) lines colour, 640 (H) lines b&w
Col/B&W	On/Off/Auto, IR-cut filter removable (ICR)

Sensitivity Colour	0.4 Lux(50IRE) 0.001 Lux (15IRE, sense up x256)
Sensitivity B&W	0 Lux LED IR on
IR LED	24 pcs.
Optical Wavelength	850 nm
Max. IR Distance	25 m
Power Consumption	4.1 W
Weight	0.5 kg
Dimensions (wxhxd)	Ø 122 x 95 mm

Specifications GCA-B0325D

Image Sensor	1/3" CCD (Sony PS Super HAD with WDR)
Resolution	600(H) lines colour, 640 (H) lines b&w
Col/B&W	On/Off/Auto, IR-cut filter removable (ICR)
Sensitivity Colour	0.4 Lux(50IRE) 0.001 Lux (15IRE, sense up x256)
Sensitivity B&W	0.04 Lux(50IRE) 0.00004 Lux (15IRE, sense up x256)
Wide Dynamic Range	On/Off, extreme backlight compensation (WDR x160)
BLC	On/ Off/ Area/ Level/ WDR
Power Consumption	2.2 W
Weight	0.32 kg
Dimensions (wxhxd)	Ø 122 x 95 mm

Specifications GCA-B0326D

Image Sensor	1/3" CCD (Sony PS Super HAD with WDR)
Resolution	600(H) lines colour, 640 (H) lines b&w
Col/B&W	On/Off/Auto, IR-cut filter removable (ICR)
Sensitivity Colour	0.4 Lux(50IRE) 0.001 Lux (15IRE, sense up x256)
Sensitivity B&W	0 Lux LED IR on
Wide Dynamic Range	On/Off, extreme backlight compensation (WDR x160)
IR LED	24 pcs.
Optical Wavelength	850 nm
Max. IR Distance	25 m
Power Consumption	4.1 W
Weight	0.5 kg
Dimensions (wxhxd)	Ø 122 x 95 mm

Dimensions

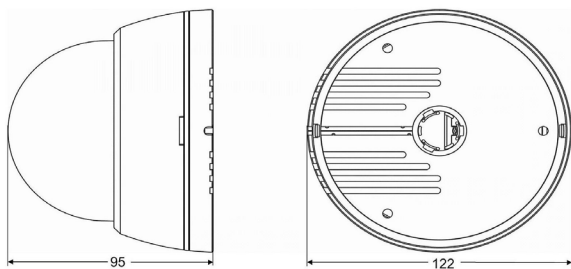

EC Declaration of Conformity

GCA-B1322D	1/3" Col/B&W Fixed Dome Camera, Vari-Focal
GCA-B0322D	1/3" Col/B&W Fixed Dome Camera, Vari-Focal
GCA-B0323D	1/3" CCD Col/B&W Fixed Dome Camera w/ IR LED
GCA-B0325D	1/3" Col/B&W Fixed Dome Camera, Vari-Focal, WDR
GCA-B0326D	1/3" CCD Col/B&W Fixed Dome Camera w/ IR LED WDR

It is hereby certified that the products meet the standards in the following relevant provisions:

EC EMC Directive 2004/108/EC
Low Voltage Directive 2006/95/EC

Applied harmonised standards and technical specifications:

EN 55022: 2006 Class A

EN 50130-4: 1995 / A2: 2003

EN 61000-3-2: 2006

EN 61000-3-3: 2008

ASP AG

Lüttringhauser Str. 9
42897 Remscheid
Germany

Remscheid, 08.11.2012



Ludwig Bergschneider
CEO