

# FOR A GOOD **REASON** **GRUNDIG**

Owner's Manual

en

Digital Recording Systems

---

GDV-B2208A	8-Ch Standalone DVR with DVD-RW H.264
GDV-A4416A	16-Ch Standalone DVR with DVD-RW H.264
GDV-C4416A	16-Ch Standalone DVR with DVD-RW H.264
GDV-B8832A	32-Ch Standalone DVR with DVD-RW H.264

---

GDV-B8832A.2.1.28.02.2011  
© ASP AG



Design and specifications are subject to change without notice



<b>Content:</b>		8. Pause Live Screen	40
<b>1. Introduction</b>	1	9. PTZ Control	41
1. Available Versions	2	<b>7. Playback</b>	43
2. Key Features of your DVR	2	1. Playback Mode	43
<b>2. Important Safety Instructions</b>	4	2. Search Mode	44
<b>3. Package Contents</b>	4	3. Copy	47
<b>4. Installation</b>	5	<b>8. Configuration</b>	51
1. Part Names and Functions	5	1. System Setup	51
2. Installation and Connection	10	2. Network	60
3. Running the OSD menu	12	3. Device Setup	62
4. Connecting and configuring ports	19	4. Event Setup	67
<b>5. Menu Use</b>	32	5. Recording Setup	72
1. Menu Structure	32	<b>9. GRUNDIG Web Viewer</b>	77
2. Function Menu	32	1. System Requirements	77
3. Factory Reset	33	2. Login	77
<b>6. Monitoring</b>	38	3. User Setup	78
1. Basic Screen	38	4. Available Browser	79
2. Single Full Screen Mode	38	5. Monitor	79
3. Multi Screen Mode	38	6. Playback	84
4. Screen Description	38	<b>10. GRUNDIG Live Mobile Viewer</b>	88
5. Sequence Mode	39	1. Log-In page	88
6. Event Screen	39	2. Monitoring page	89
7. Zoom Screen Mode	40		

---

## 1. Introduction

Thank you for purchasing a GRUNDIG digital video recorder.

This manual is for GDV-B2208A, GDV-A4416A, GDV-C4416A and GDV-B8832A. Before product installation and operation, please become thoroughly familiar with this user manual and other manuals referenced by this manual.

This user manual, the software and the hardware described here are protected by copyright law. With the exception of copying for general use within fair use, copying and reprinting the user manual, either partially or in entirety, or translating it into another language without the consent of ASP AG is strictly prohibited. This specification may change without prior notice for improvement of product performance.

### Product Warranty and Limits of Responsibility

The manufacturer does not assume any responsibility concerning the sale of this product and does not delegate any right to any third party to take any responsibility on its behalf. No warranty is offered for any attachments or parts not supplied by the manufacturer. The product warranty does not cover cases of accidents, negligence, alteration, misuse or abuse, for example:

- Malfunctions due to negligence by the user
- Deliberate disassembly and replacement by the user
- Connection of a power source other than a properly rated power source
- Malfunctions caused by natural disasters (fire, flood, tidal wave, etc.)
- Replacement of expendable parts (HDD, FAN, etc.)
- The warranty period for the HDD and Fan is one year after purchase.

This product is not for exclusive use of crime prevention but also for assistance in cases of fire. We take no responsibility for damage from any incident.

**Caution:**

This equipment underwent EMC registration and is suitable for business purposes. Distributors and users are aware of this point.

**Warning:**

This is a class A product. In a domestic environment this product may cause radio interference, in which case the user may be required to take adequate measures.

**Warning:**

1. In case of changing the built-in lithium battery, it should be replaced with the same or a kindred one to prevent danger of explosion. Since old batteries could be a factor of environment contamination, be cautious how you treat them.
2. Do not throw the batteries into fire or other heat. Short circuit or disassembly is prohibited.
3. Do not charge the batteries provided with the remote control.

**1.1. Available Versions**

These instructions apply to the following products. For the different properties of the products please refer to the table.

Model	Channels	CIF speed	2CIF speed	4CIF speed	NAS	DVI
GDV-B2208A	8	200 fps	200 fps	100fps	-	1
GDV-A4416A	16	400 fps	200 fps	100fps	-	1
GDV-C4416A	16	400 fps	400 fps	400fps	1	2
GDV-B8832A	32	800 fps	800 fps	400fps	1	2

**1.2. Key Features of your DVR**

**Monitoring Screen**

The DVR supports real live video with high resolution per each channel and variable display mode.

- Real H.264 Video
- Variable display mode
  - GDV-B2208A : 1/4/8 channel mode
  - GDV-A4416A : 1/4/9/10/16 channel mode
  - GDV-C4416A : 1/4/9/10/16 channel mode
  - GDV-B8832A: 1/4/9/10/16 channel mode

- Auto Switching
  - GDV-B2208A : Composite x 2, DVI x 1
  - GDV-C4416A : Composite x 4, DVI x 2
  - GDV-A4416A : Composite x 2, DVI x 1
  - GDV-B8832A : Composite x 4, DVI x 2

**Audio Recording**

The DVR supports real-time audio input and recording.



- 
- Simultaneous 4ch audio input & recording available  
For GDV-B8832A & GDV-C4416A: Input: 4Ch RCA, 12Ch D-Sub, Output: 1Ch (Rear)  
For GDV-A4416A & GDV-B2208A: Input : 4Ch, Output: 1ch (Rear)

- Simultaneous audio recording and playback available

#### Recording

The DVR supports max.800ips (GDV-B8832A), 400 ips (GDV-C4416A / GDV-A4416A) or 200ips (GDV-B2208A) recording at High-Resolution (H.264).

- Supports manual & schedule recording
- Video loss detection
- Supports archiving event lists (Sensor, Video Loss, Motion Detection, Text)
- Possible to record max. 5 seconds before triggering an event per each channel
- A convert function is available to protect the privacy

#### Search / Playback

The DVR supports variable and convenient functions for search & playback.

- Playback by time, date, channel
- Easy and convenient search using a mouse
- Pre/post search from a freeze frame
- Playback by Event (Sensor, Video Loss, Motion Detection, Text)
- Easy & convenient search using a Remote Control & Jog/Shuttle

#### Backup device

It is possible to create backups through DVD-R, CD-R or USB memory if necessary.

- Supports various backup devices: DVD-R, CD-R, USB memory
- HDD Extention over eSATA connection

#### Network

The DVR supports access over LAN or xDSL and can be easily controlled from a dedicated PC with the GRUNDIG Control Monitoring Software.

- E-mail notification through TCP/IP, DHCP in case of a triggering event
- Live monitoring from remote site
- Available to playback, recording, search and DVR management with the GRUNDIG Control Center
- Possibility to record, search & play back by time with the Microsoft Internet Explorer
- Supports 10/100Mbps Ethernet/xDSL
- Multiple DVR connection

#### Other functions

- Supports User friendly GUI and a mouse function
- Easy and simple firmware upgrade through USB memory or over LAN
- Recorded data backup through USB port
- PTZ Control (SPEED DOME), PRESET function

---

- Possibility to control up to 16 DVRs with one remote control

## 2. Important Safety Instructions

1. Do not place heavy objects on the top of the product.
2. This Product is for indoor use. It is not weatherproof. Please use the product considering its environmental specifications (Temperature & Humidity). To clean the product, gently wipe the outside with a clean dry cloth.
3. This Product uses AC power of 110V ~ 240V. Be cautious not to cause electric damages to the product.
4. Be careful not to drop the product. Physical shocks may harm the product including the internal HDD. In addition, be sure the product is secured after installation.
5. This Product is made of metal. Therefore you can hurt human beings if you throw it to them or hit it on them. When installing the product, be cautious to locate it in safe places where children cannot reach it.
6. If the product does not operate properly, please contact the closest GRUNDIG distributor for after sales service. Tampering or disassembling the product will cause expiration of the warranty.
7. Security surveillance laws may differ for each country. Therefore, please contact the local region first to avoid any surveillance law violations.
8. Experience and technical skills are needed for the installation of this product as an improper installation may cause fire, electric shocks, or defects. Any installation job should be performed by the vendor you purchased this product from.

The content of this manual can differ according to firmware or software upgrading. The standard and appearance of the products may be changed for the improvement of quality without an advance notice.

## 3. Package Contents

These parts are included:

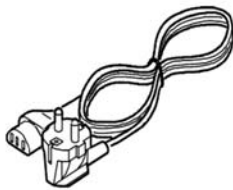

AC Cord

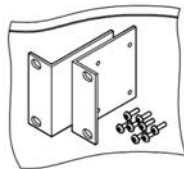

Bracket

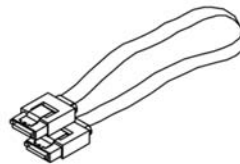

SATA HDD Cable  
(built-in)

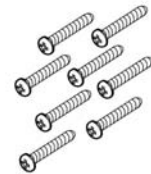

Screws for HDD

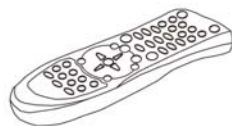

Remote Control  
(battery included)



Setup CD

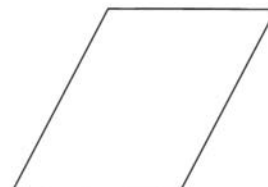

Quick Guide

## 4. Installation

### 4.1. Part Names and Functions

Front view of GDV-B2208A:

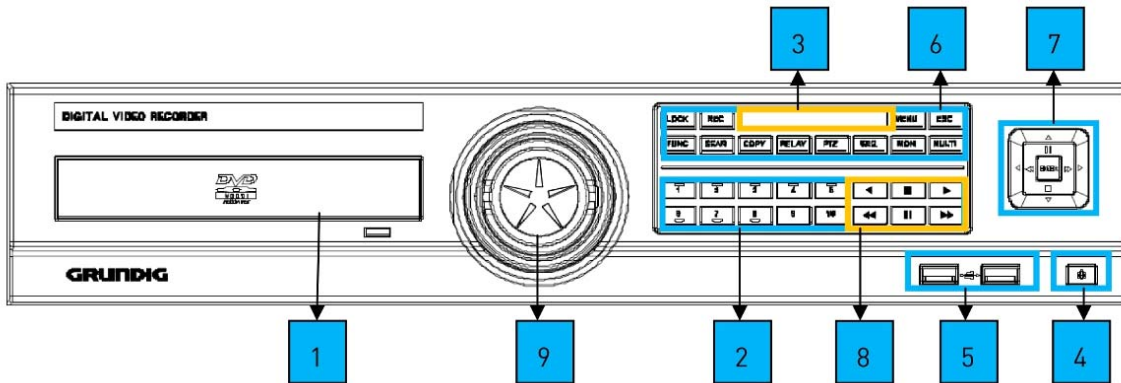

Item	Description
1	DVD-Multi (for Backup) Backup for recorded data by DVD/CD media
2	Channel Buttons To select a video input channel
3	REC LED Displays recording status
	COPY LED Displays copy status
	HDD LED Displays HDD running
	NET LED Displays network connection
	EVENT LED Displays event detection
4	Power To turn the power on/off
5	USB port For connecting with USB memory or mouse
6	REC To start or stop manual recording
	MULTI To change DIVISION in live or playback mode
	SEQ To run or stop user sequence
	COPY To enter copy mode
	SEAR To enter search mode
	PTZ To start PTZ function or stop
	FUNC To enter function menu
	RELAY Manual On/Off button for relay
	MON To change the monitor
	MENU To enter the menu
	ESC To exit menu or close a pop-up window
7/8	Enter/Play ▶ To enter playback mode or select a menu
	◀/REW ◀◀ To move or select in menu and change replay speed in reverse direction in playback mode
	▶/FWD ▶▶ To move or select in menu and change replay speed in forward direction in playback mode
	▲/Pause II To move or select in menu and pause live/replay video
	▼/Stop ■ To stop replay in playback mode
9	Jog/Shuttle STEP function control, Playback direction change, Playback speed control

Front view of GDV-A4416A / GDV-C4416A / GDV-B8832A:

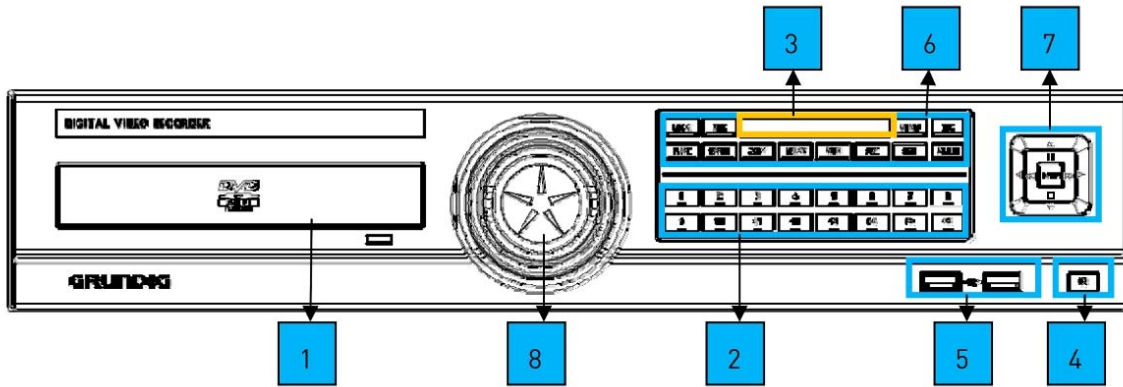

Item		Description
1	DVD-Multi (for Backup)	Backup for recorded data by DVD/CD media
2	Channel Button	To select video input channel (GDV-C4416A : 1 ~ 16ch GDV-B8832A : 1 ~ 32ch)
3	REC LED	Displays recording status
	COPY LED	Displays copy status
	HDD INT	Displays HDD running for internal HDD
	HDD EXT	Displays HDD running for external HDD
	NET LED	Displays network connection
	EVENT LED	Displays event detection
4	Power	Turn the power on/off
5	USB port	Use connecting USB memory or mouse
6	REC	To start or stop manual recording
	MULTI	To change DVISION in live or playback mode
	SEQ	To run or stop user sequence
	COPY	To enter copy mode
	SEAR	To enter search mode
	PTZ	To start PTZ function or stop
	FUNC	To enter function mode
	RELAY	Manual On/Off button for relay
	MON	To change the monitor
	MENU	To enter menu
	ESC	To exit menu or close a pop-up window
	LOCK	To lock the front key
7	Enter/Play ▶	To enter playback mode or select a menu
	◀/REW ◀◀	To move or select in menu and change replay speed to reverse direction in playback mode
	▶/FWD ▶▶	To move or select in menu and change replay speed to forward direction in playback mode
	▲/Pause	To move or select in menu and pause live/replay video
	▼/Stop ■	To stop replay in playback mode
8	Jog/ Shuttle	STEP function control, Playback direction change, Playback speed control

Rear view of GDV-B2208A:

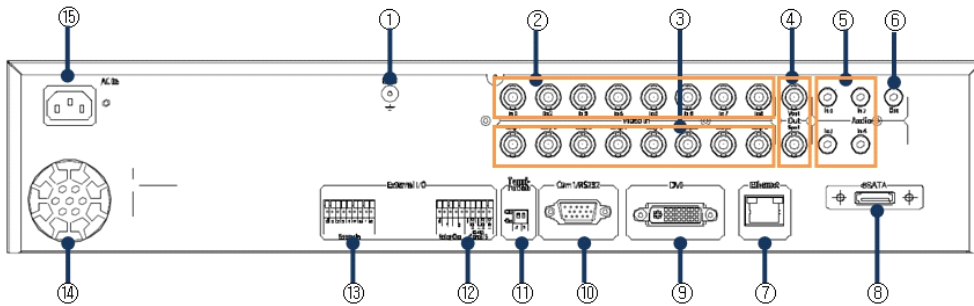

No.	Input/ Output name	Description
1	Ground	Ground between DVR & external device
2	CH1~8	BNC input for camera connection GDV-A4416A : 16EA, GDV-B2208A : 8EA
3	Loop out	BNC output (Loop)
4	Monitor/Spot	BNC connection for monitor output
5	Audio Input (RCA)	RCA connection for Audio input
6	Audio Output	Speaker output terminal
7	Ethernet	For network connection [RJ-45]
8	eSATA	eSATA external storage connection
9	DVI OUTPUT	Output for DVI monitor connection
10	RS-232C D-Sub	Text equipment, Keyboard connection
11	Termination Ohm	Termination Ohm for Com2, Com3
12	Relay/Serial	Connection for Relay and Serial (RS-485)
13	Sensor IN	Input for external sensor
14	FAN	Cooling system against overheating
15	Power connector	Socket for AC100V~AC240V power cord

Rear view of GDV-A4416A:

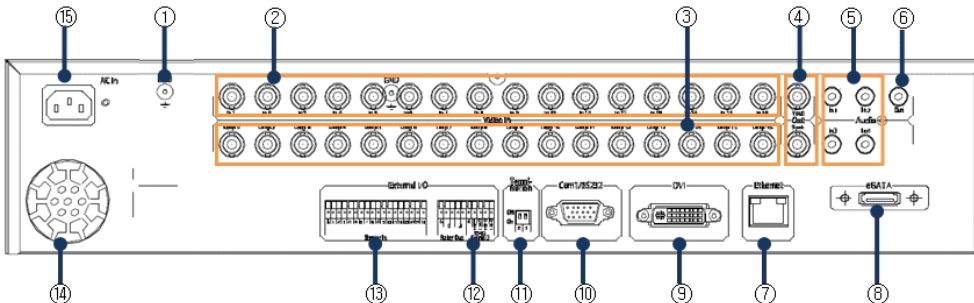

No.	Input/ Output name	Description
1	Ground	Ground between DVR & external device
2	CH1~16	BNC input for camera connection GDV-A4416A : 16EA, GDV-B2208A : 8EA
3	Loop out	BNC output (Loop) for camera connection
4	Monitor/Spot	BNC connection for monitor output
5	Audio Input (RCA)	RCA connection for audio input
6	Audio Output	Speaker output terminal
7	Ethernet	For network connection [RJ-45]
8	eSATA	eSATA external storage connection
9	DVI OUTPUT	Output for DVI monitor connection
10	RS-232C D-Sub	Text equipment, Keyboard connection
11	Termination Ohm	Termination Ohm for Com2, Com3
12	Relay/Serial	Connection for Relay and Serial (RS-485)
13	Sensor IN	Input for external sensor
14	FAN	Cooling system against overheating
15	Power connector	Socket for AC100V~AC240V power cord

Rear view of GDV-C4416A & GDV-B8832A:

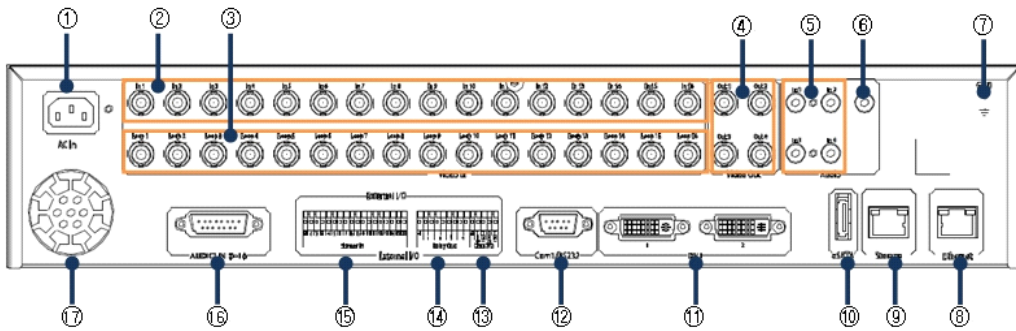

No.	Input/ Output name	Description
1	Power connector	Socket for AC100V~AC240V power cord
2	CH1~16	BNC input for camera connection
3	Loop out (CH17 ~ 32)	BNC Loop for GDV-C4416A BNC input (CH17 ~ 32) for camera connection for GDV-B8832A
4	Monitor 1~4	BNC connection for monitor output
5	Audio input(RCA)	RCA connection for Audio input
6	Audio output	Speaker output terminal
7	Ground	Ground between DVR & external device
8	Ethernet	For network connection (RJ-45)
9	Storage	For external HDD connection
10	eSATA port	For eSATA external HDD connection
11	DVI OUTPUT 1,2	Video output port to connect a PC monitor
12	Com1	RS-232C D-SUB
13	Com2,3	For RS-485
14	Relay	Relay Connection terminal
15	Sensor IN	Input for external sensor
16	D-Sub Audio port	D-Sub port for audio
17	Fan	To exhaust internal heat

## Remote Control:

It is possible to use all functions of the DVR with the remote control,. If several DVRs are set with unique ID numbers, they can be controlled with one remote control. To use the remote control, it is necessary to set first the ID which you want to use. Keep pressing the ID button repeatedly (up to max. 16 times) and use it for matching DVR & ID.

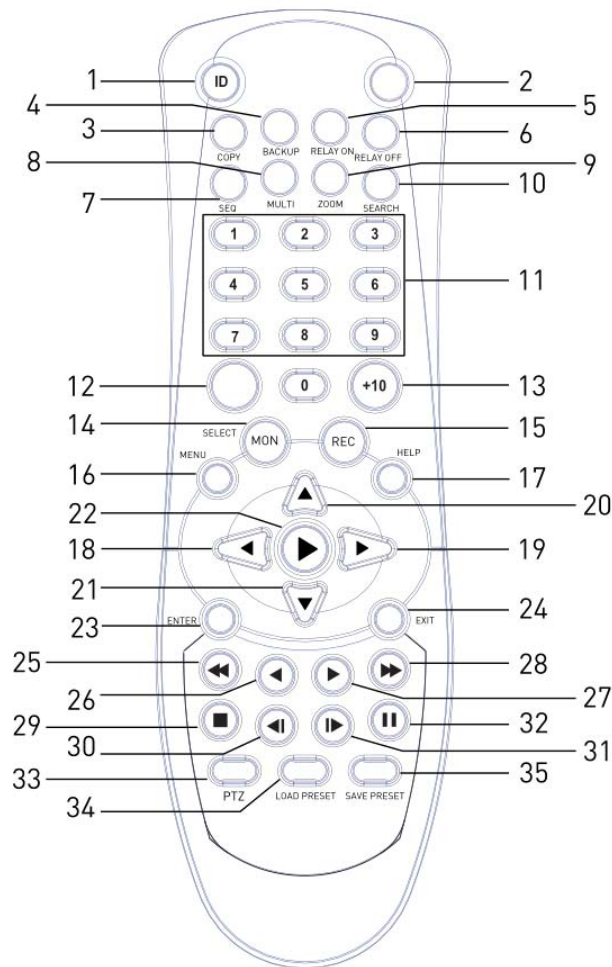

No.	Item	Description
1	ID	To select a Remote Control ID
2	LOCK	Not used
3	COPY	To indicate the copy menu, to copy recorded data to USB
4	BACKUP	Not used
5	RELAY ON	To manually turn a relay ON
6	RELAY OFF	To manually turn a relay OFF
7	SEQ	Auto sequencing
8	MULTI	To change division
9	ZOOM	To run digital zoom
10	SEARCH	To enter search mode
11	CHANNEL BUTTONS	To select a channel
12	SELECT	Not used
13	+10	In case of selecting a number over 10 (+10 + 1)
14	MON	To change the monitor
15	REC	To start or stop manual recording
16	MENU	Enter menu screen
17	HELP	Not used



No.	Item	Description
18	< / REW	Move the setting menu to left direction/REW
19	> / FWD	Move the setting menu to right direction/FWD
20	^ / PAUSE	Move the setting menu to top direction/PAUSE
21	v / STOP	Move the setting menu to bottom direction/STOP
22	▶ / PLAY	Playback
23	ENTER	To select a menu
24	EXIT	To cancel setting, exit menu
25	FAST REWIND (◀◀)	Speedy replay to reverse direction
26	REWIND PLAY (◀)	Replay to reverse direction
27	FORWARD PLAY (▶)	Replay to forward direction
28	FAST FORWARD (▶▶)	Speedy replay to forward direction
29	STOP (■)	To stop replay
30	STEP REVERSE (◀ )	Replay to reverse direction by each frame
31	STEP FORWARD ( ▶)	Replay to forward direction by each frame
32	PAUSE (  )	To freeze playback
33	PTZ	PAN/TILT/ZOOM Control
34	LOAD PRESET	To read preset
35	SAVE PRESET	To save preset

## 4.2. Installation and Connection

Connecting the camera:

Connect the CCTV camera to the DVR using the BNC cable as shown below:

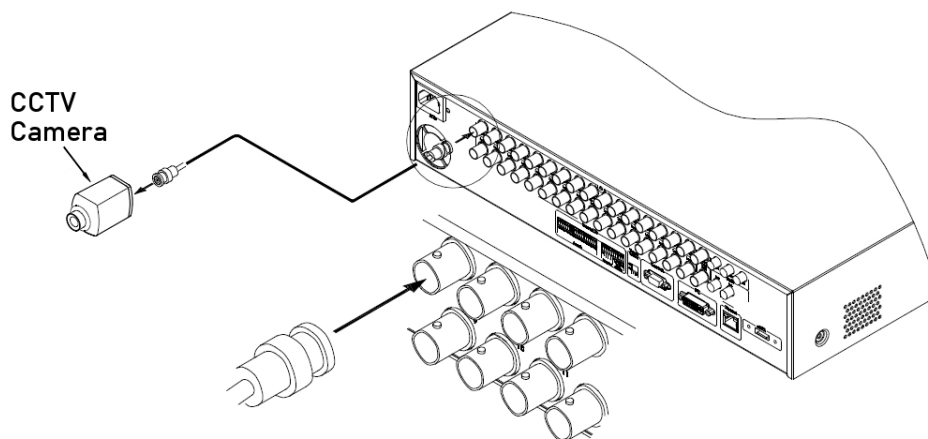

- The video type for all channels should be either NTSC or PAL. Do not combine them with each other.
- The DVR sets the video signal's impedance (75Ω) automatically. The Impedance is set to 75 Ω basically. When connecting a device to video output, the impedance will be changed to "Hi-z" status.
- The Video Type (NTSC/PAL) should be directly set after booting the DVR. The order of the camera recognition starts with Ch1 up to Ch8 (Ch16 or Ch32) and the 1st recognized camera type will indicate all other camera types.



---

Connecting the monitor:

Connect either a CCTV monitor with a BNC cable to the DVR as shown below, or connect the monitor with a DVI cable through the DVI port. Use a DVI-VGA adapter or a DVI-HDMI adapter if your monitor does not support a direct DVI connection. (The adapter is not included in the package.)

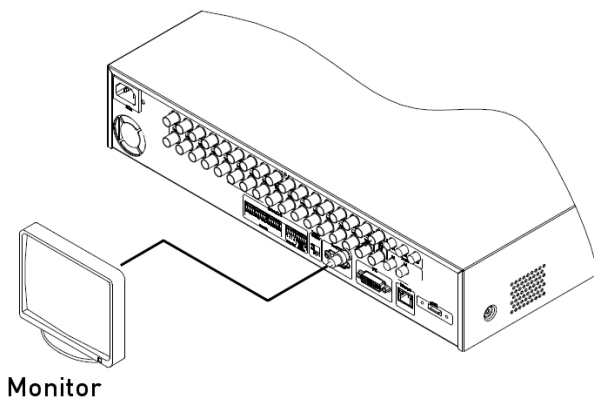

Connecting Audio:

Connect the audio signal to the DVR using the RCA cable or a D-Sub connector as shown below:

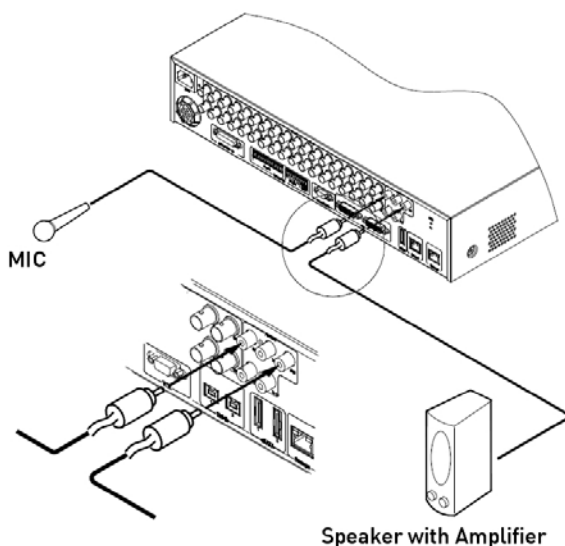

Supplying Power:

Connect the power cable as shown below:

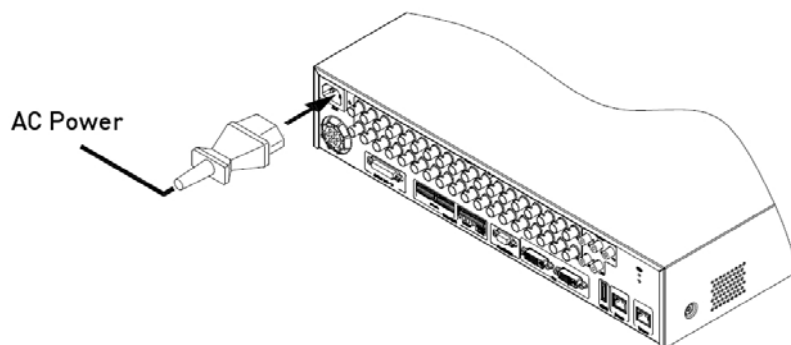

- When supplying the DVR with power, the DVR starts booting automatically.
- In order to cut off the power, press the power switch on the DVR front for 5 seconds. When a pop-up window appears, select "YES" to shut down the DVR.
- For supplying the DVR with power again, push the Power button.

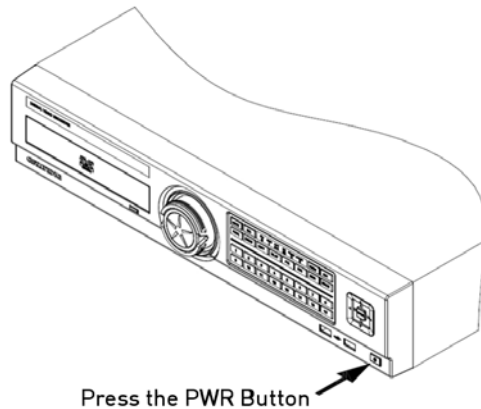

### 4.3. Running the OSD menu

The OSD can be controlled with the keypad on the front panel of the DVR, with a remote control or with an USB mouse. In this manual we will refer to the keys of the front panel, as the procedure with a remote control and a mouse is almost identical.

#### 4.3.1. OSD Menu Configuration

Press [MENU] on the keypad on the front to open the configuration menu as shown below:

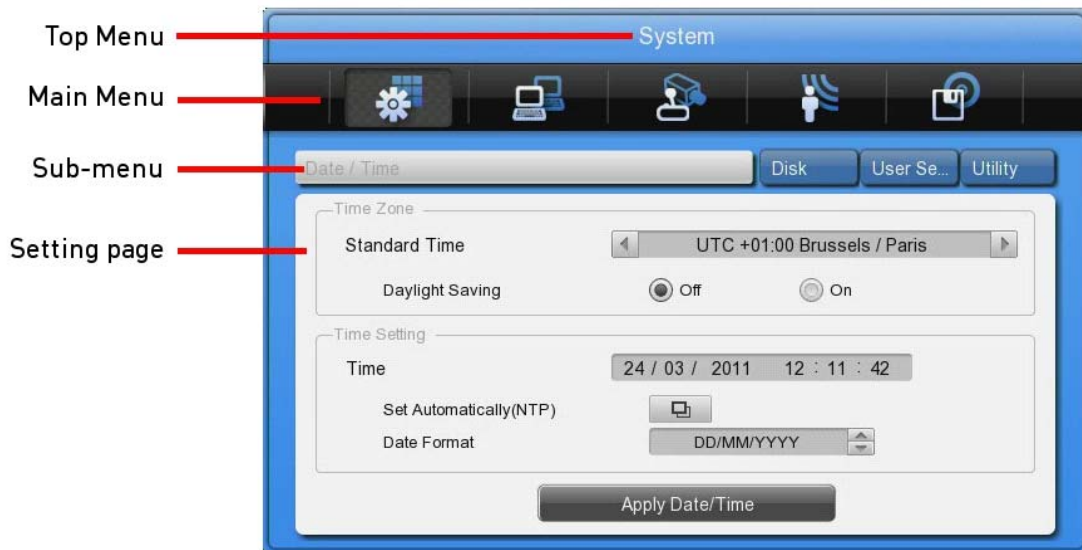

(1) Main Menu : The selected tab is shown in bright colour and the related sub-menu will be shown on the left, below the tab. To move to the previous/next tab, use the [◀/▶] arrow buttons. To move to a sub-menu press the [Enter] key.

(2) Sub-menu : The selected sub-menu is shown as a tab title and the related setting will be shown. To move to the previous/next tab, use the [◀/▶, ▲/▼] arrow buttons. To move to the related setting press [Enter]. To move to an upper main menu, press the [ESC] button.

(3) Setting page : The selected tab is shown in blue. To move to the previous/next tab, use the [◀/▶] or [▲/▼] arrow button and press the [Enter] key for value setting. When setting the value is a word, a dialogue box to edit the word will open. When setting the value is a number, it should be set with using [◀/▶] or [▲/▼]. Press the [ESC] button when the value is set. With the [ESC] button it is also possible to move to the upper sub-menu.

Dialogue box to edit a word:

The dialogue box to edit a word is shown below. It is possible to input both word and number.



Keep pressing the [▲/▼], [◀/▶] arrow buttons until the word is typed in, then press [Enter]. In case of deleting press [←], for spacing press the [→] button. To exit the dialogue box, press [Enter] after having finished the word input.

#### 4.3.2. Setting the remote control

Setting the ID of the DVR:

When controlling several DVRs with one remote control, set the Remote Control ID as follows:



- (1) Press the [MENU] button.
- (2) Select "System" by using the [▶] arrow button and press [Enter] or the [▼] button.
- (3) Select "Utility" by using the [▶] arrow button and press the [Enter] button.
- (4) Select "Remote Controller ID" and press [Enter].
- (5) [◀/▶] Select a value using the [◀/▶] arrow buttons and press [ESC].
- (6) Press the [ESC] button to return to monitor mode.

#### NOTE:

Up to 16 DVRs can be controlled with a single remote control. If you do not use a remote control, set the Remote Controller ID to "Off".

Selecting an ID:

If there are several DVRs with unique ID numbers, they can be controlled with one remote control. To select a specific DVR, keep pressing the ID button of the remote control until you hear a signal sound for the duration of 2 seconds.

Operable range of the remote control:

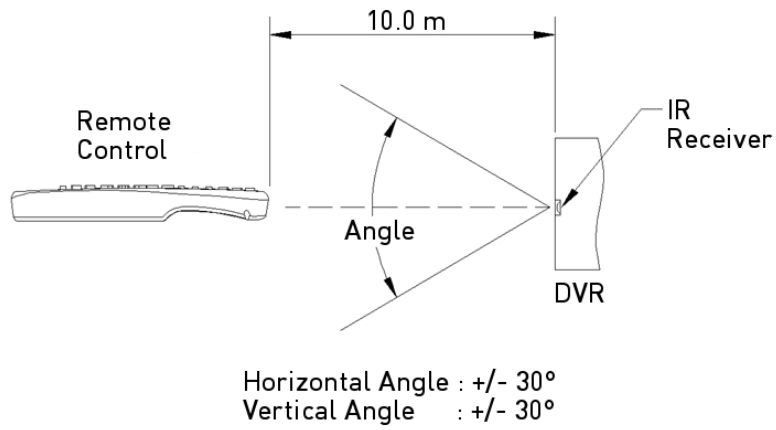

Loading the batteries into the remote control:

The remote control requires two AAA-type batteries. Please refer to the following installation steps.

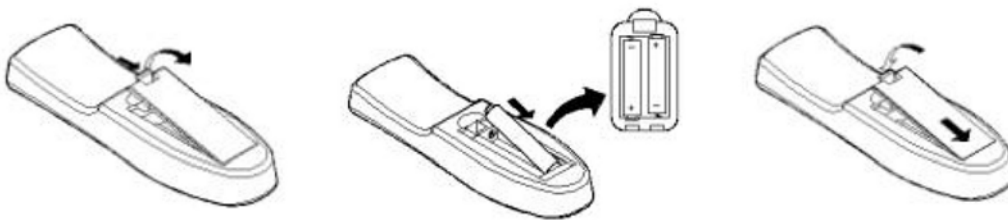

1. Remove the battery cover.

2. Take care that the poles (+/-) are correctly positioned.

3. Replace the battery cover.

#### 4.3.3. Different configurations

Basic configuration:

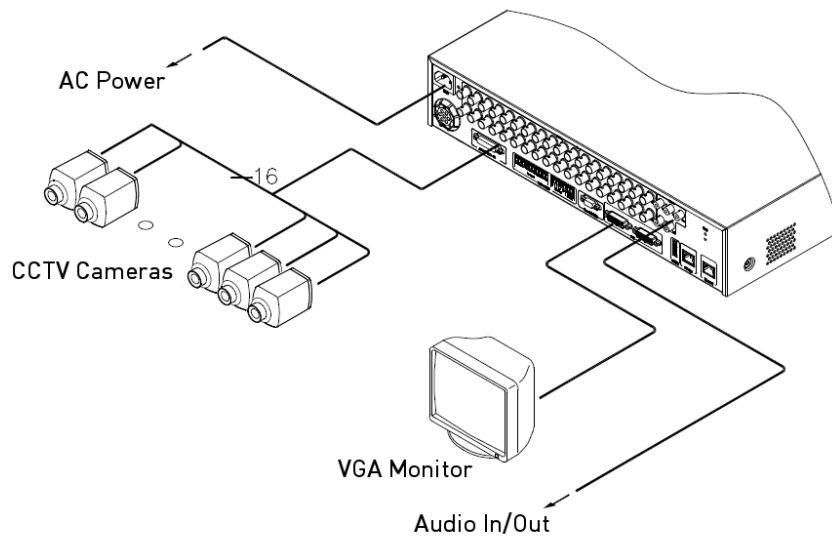

Advanced configuration:

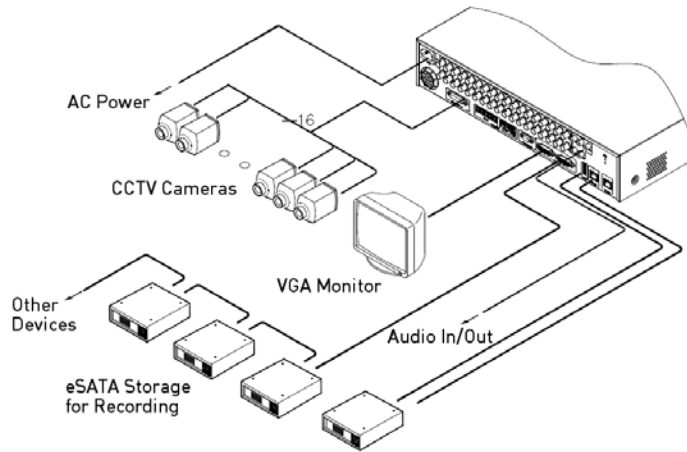
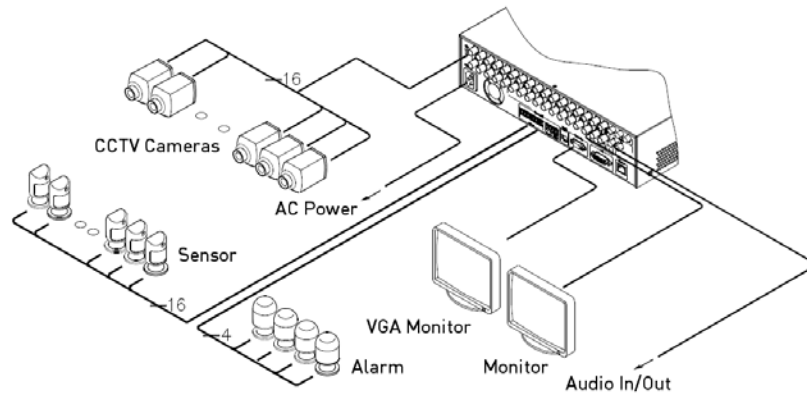

Connection to an USB storage device for backups:

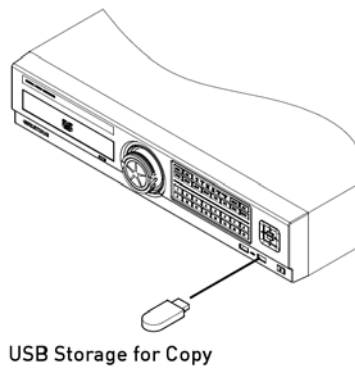

Internet/Intranet configuration:

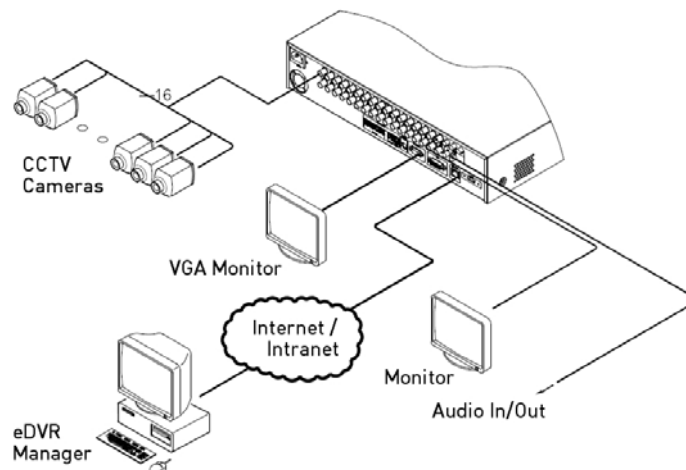

#### 4.3.4. Basic Settings

Viewing Image:

When powered on the DVR starts automatically and displays a basic 16ch-split or 8-split screen (GDV-B2208A).



NOTE:

After booting the recorder, by default a prompt for entering the password will appear. You can change this in the system settings. The default admin password is: 1234.

Setting Date & Time:

- Press the [MENU] button and select "System" when the OSD menu appears.
- Select "Date/Time" and press the [Enter] button.

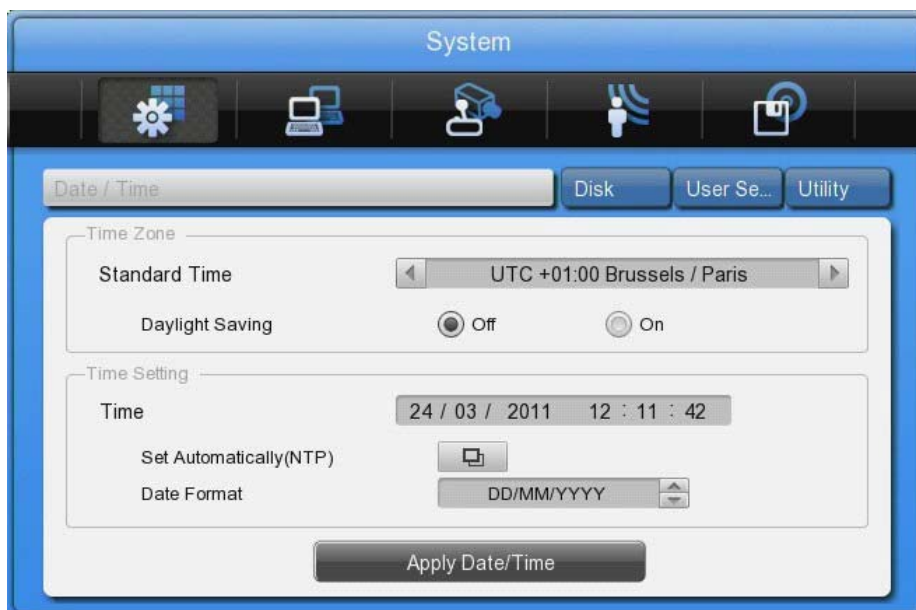

Time Zone:

- (1) Select "Time Zone" using the [◀/▶] or [▲/▼] arrow buttons and press the [Enter] button.
- (2) [◀/▶] Select "Time Zone" using the [◀/▶] arrow buttons and press the [ESC] button.

Daylight saving:

- (1) Summer Time is only selectable for the Time Zones which use Daylight savings.
- (2) Select "Daylight Saving" using the [◀/▶] or [▲/▼] arrow buttons and pressing the [Enter] button.
- (3) Select On/Off using the [◀/▶] arrow buttons and pressing the [ESC] button.

NTP:

- (1) Select NTP if you want to enable the NTP Function.
- (2) Select "Client or Server or Both" using the [◀/▶] or [▲/▼] arrow buttons and press the [Enter] button.
- (3) Select "Public or Both" using the [◀/▶] arrow buttons and press the [ESC] button in 'Client or Both' mode.
- (4) Enter the 'Server IP address' when you set the next server as Local.
- (5) Set Server and Communicate cycle with Interval.

---

#### Date Format:

(1) Select "Date Format" using the [◀/▶] or [▲/▼] arrow buttons and press the [Enter] button. Select a value using the [◀/▶] arrow buttons from YYYY/MM/DD, MM/DD/YYYY, DD/MM/YYYY.

(2) Press [ESC] after finishing the value setting.

#### Time:

(1) Select the Date and Time using the [◀/▶] arrow buttons and set a value using the [▲/▼] arrow buttons.

(2) Press [ESC] after finishing the value setting.

#### Important Notification!

Most setting values are applied automatically, when exiting the related menu page. In contrast, "Date" & "Time" settings are not applied automatically because they may critically affect the file system of the recorded HDD. To apply Date/Time settings confirm with the [Apply Date/Time] button.

(1) Select "Apply Date/Time" using the [◀/▶] or [▲/▼] arrow buttons and press [Enter]. Then a warning message will appear as shown below;

(2) Select "YES" using the [◀/▶] or [▲/▼] arrow buttons, then press the [Enter] button. To cancel, press the [ESC] button.



Record settings:

- (1) Press the [Menu] button and select "Record" when the OSD menu appears.
- (2) Move to the sub-menu "Record" by pressing [Enter].
- (3) Select the Record Mode (Continuous & Event or Schedule & Event).
- (4) Set the pre-alarm and post-alarm recording times.

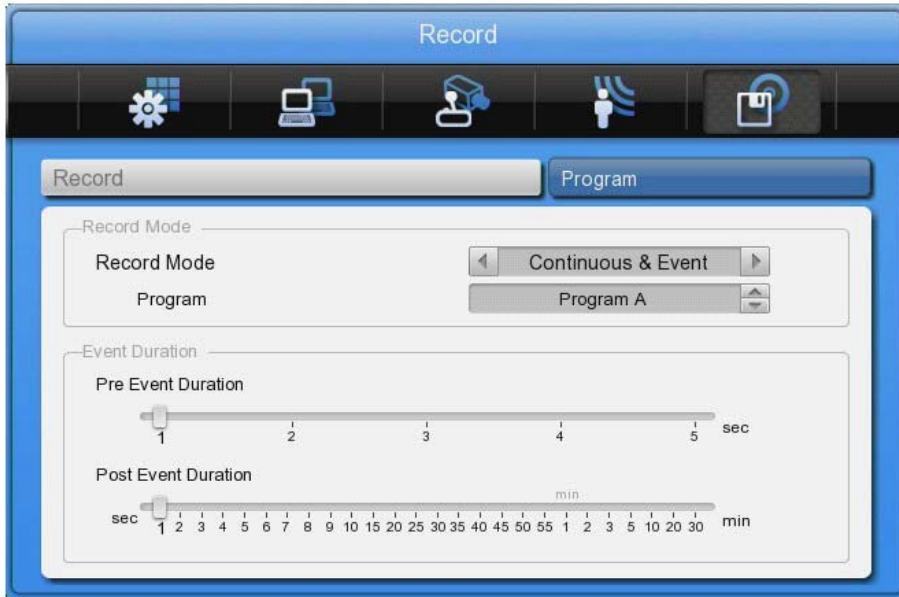

Program Setting:

Set the resolution, the frame rate and the quality for each channel for normal recording and event recording in the "Program" sub-menu of the "Record" menu.

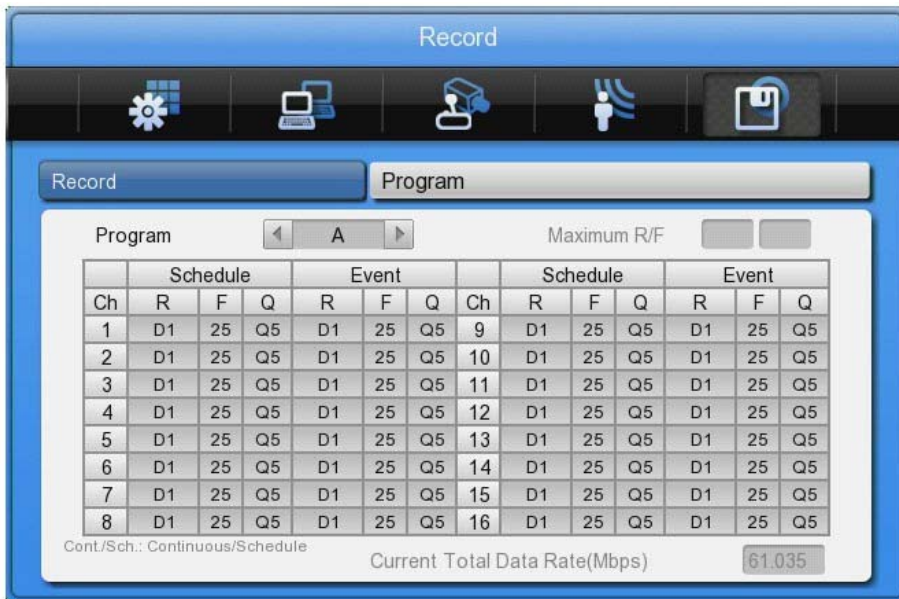



## Schedule Setting:



Set the recording mode as "Schedule & Event" and set the date, the time and the program with which you want to record. You can record at different dates with different programs.

### NOTE:

If the recording settings are finished correctly, the "REC LED" on the front will flicker. In addition, a [S] on the status tab will indicate that all channels are recording.

## 4.4. Connecting and configuring ports

### 4.4.1. Wire Handling

When connecting a wire to a terminal block, follow the instructions below. Note the different types of wire that can be used.

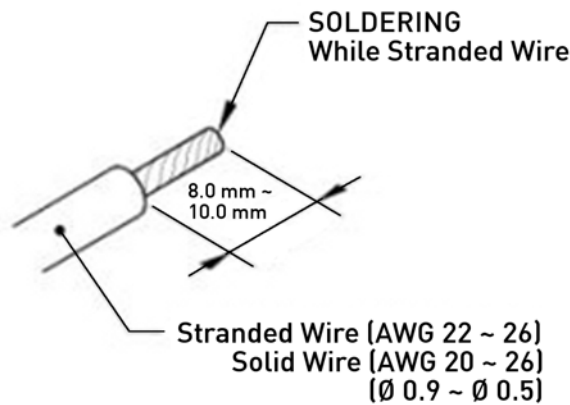

- Stranded wire : Peel 8~10 mm of the wiring cover and solder it. Wire gage should be AWG 22~26.
- Solid wire : Peel 8~10 mm of the wiring cover and solder it. Wire gage should be AWG 20~26.

#### 4.4.2. Inserting & removing wires

To insert & remove wires in the Terminal Block use a screwdriver as shown below in the diagram.

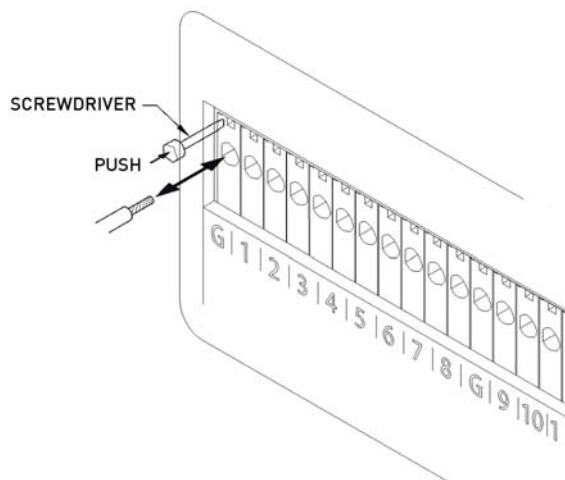

#### 4.4.3. Connecting and configuring sensor connections

Specification:

Spec.	Input Ch.	Transistor input GDV-B8832A, GDV-C4416A, GDV-A4416A : 16EA, GDV-B2208A : 8EA
	Input type	N.C., N.O. supported
	Supported sensor	Dry contact sensor
	Way of connecting	Connect the trimmed wire to terminal block
Performance	Available input pulse range	Minimum 500ms
	Output current	Typical DC 12mA

Connecting a sensor:

Refer to the following images for connecting S1 ~ S16 (S8, S4). It shows how to connect a dry contact (please also refer to "Wire Handling").

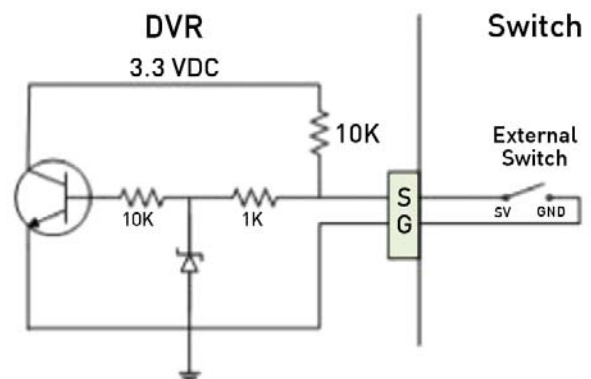
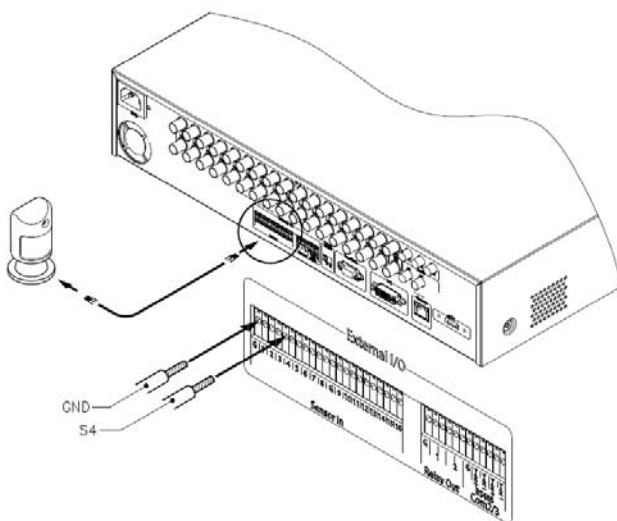

Sensor Settings:

- (1) Press the [Menu] button and select "Event" when the OSD menu appears.
- (2) Move to the sub-menu "Event" by pressing [Enter].



Setting for all sensors:

This setting is used to set the status of all sensors. The sensors can be set to Off, or Normal Open (N.O.) / Normal Close (N.C.) type.

Select All and set the type.

Setting for a single sensor:

This setting can be used when for each sensor a different setting is required.

- (1) Select a sensor and press the [Enter] button.
- (2) Select the sensor type.
- (3) Press [ESC] after the value is set.

Connecting and setting of relays:

Specification:

In order to run the relay output of the DVR normally, the following conditions are required.

Spec.	Output Ch.	2EA relay outputs
	Output type	Dry contact
	Connecting type	Trimmed wire
Performance	DC	30V 1A
	AC	125V 0.5A

Connecting relays:

Connect R1~R2 with reference to the following images which show how to connect a warning light. Please also refer to "Wire Handling".

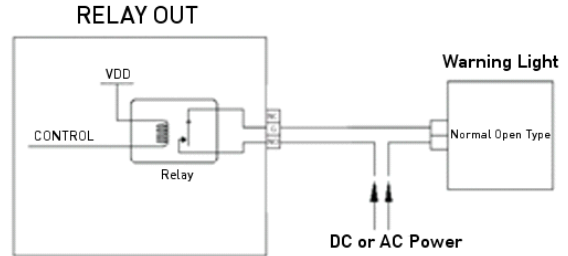
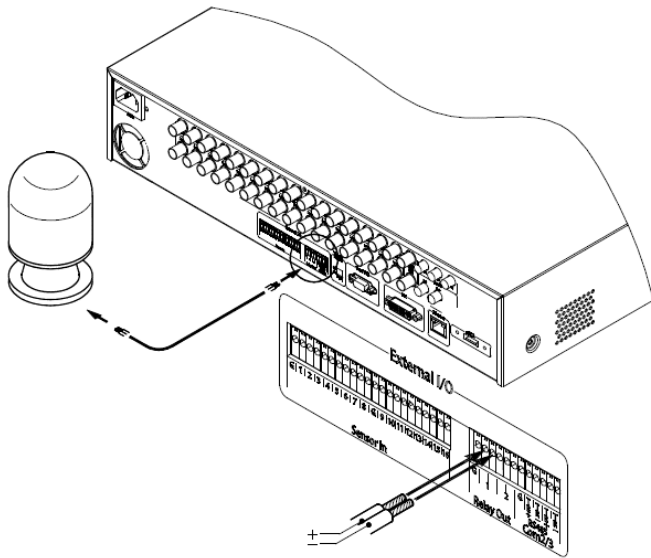

Relay settings:

The DVR can activate relays from different events, such as sensor activation, motion detection or the loss of a video signal. It is also possible to set system errors like Disk error, Disk full, authentication fail and DDNS registration as triggers for such relay activation. If the Event Check is set to Custom, a schedule for the event check can be created. In the case of using the control center software through a network, the relays can also be activated from a remote location.



---

## Serial Port Configuration:

### Configuring serial ports for Pan/Tilt/Zoom cameras:

The DVR supports the control of PTZ cameras over the COM port. For a list of supported protocols, please refer to the list on the OSD configuration menu. The following image shows how to connect a PTZ camera to RS485 (COM2/COM3). When using another serial port, connect it while referring to the connection diagrams below. Please also refer to "Wire Handling".

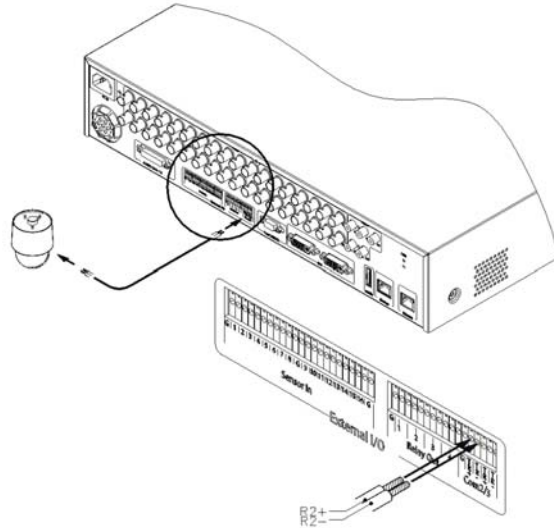

### Serial communication port diagram:

#### COM1 Connection (RS-232)

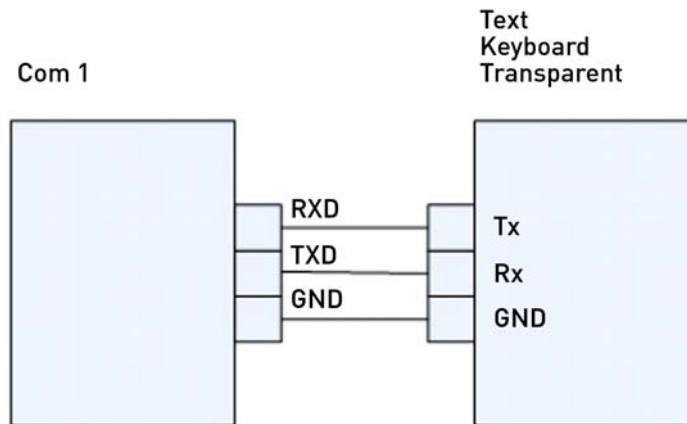

#### COM2/COM3 Connection (RS-485)

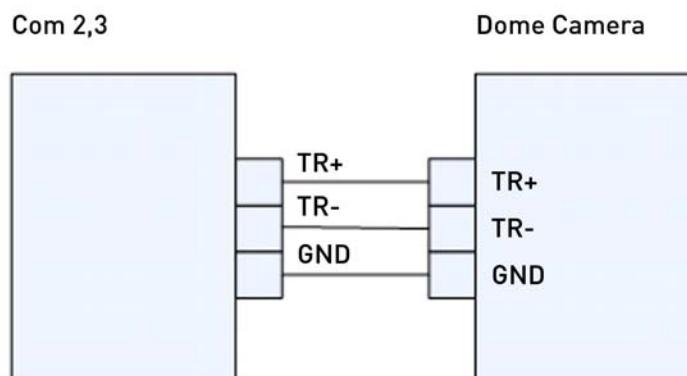

The following PTZ protocols are supported by the DVR:

Model Name	Manufacturer
BOSCH AutoDome, TC8560X-4	Bosch
PELCO(P), PELCO(D)	Pelco
Sony EVI-D3x	Sony
VT VPT-4x	VT
AD SpeedDome	AD
SungJin SJ372R1	Sungjin
Samsung SCC641	Samsung Electronics
Panasonic WV-CS850	Panasonic
SDZ160/330, Samsung SPD, Keyboard SCC3000, Samsung SRX-100B	Samsung Techwin
LG GAC-PT2	LG
Merit-Lilin FastDome	Merit
Elmo PTC200C	Elmo
Canon VC-C4	Canon
HTC-230S	Dongyang Unitech
Honeywell 755/655, HRX-2000, ScanDome2	Honeywell
RVision	RVT
Elbex	Elbex
VIDO	VIDO
VICON	Vicon
Hunt	Hunt
ORX-1000	Sysmenia
Fine CRR-1600	LiveEye
Tokina	Tokina
Kodicom KRE	Kodicom
Nuvico	Nuvico

Serial Connection Settings:

You can set up the serial port and the PTZ configuration in the "Device" menu.



In the serial setting, you can set the protocol, port, baud rate, parity bit, stop bit and data bit. After completing the serial setting, select a desired channel from the camera menu, and set up PTZ Home, PTZ Idle Time, PTZ Port, and PTZ address.

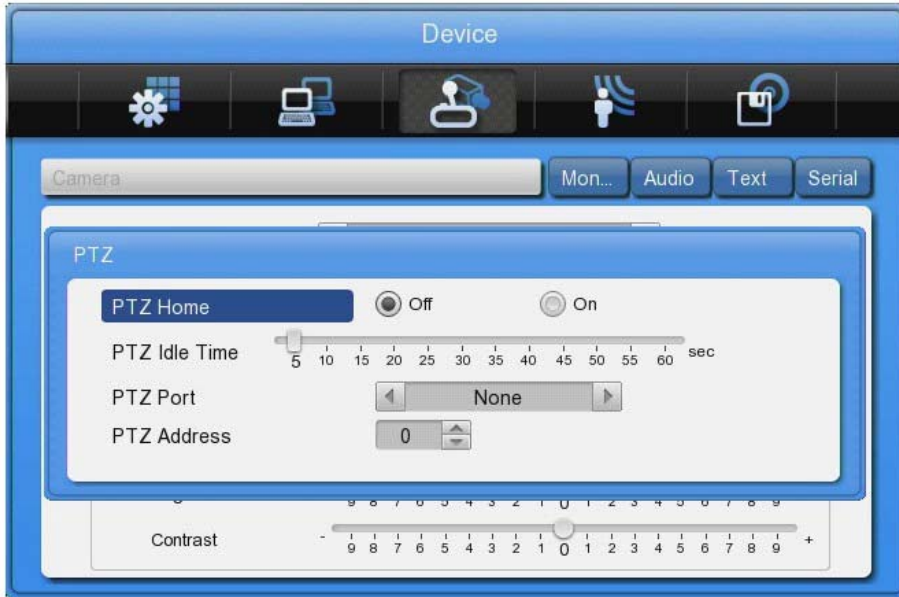

Connection to external device via Serial port:

Text input device connection (ATM / POS / Access Control):

Using the COM1/RS232 port, TEXT DATA can be recorded with a synchronised POS/ATM.

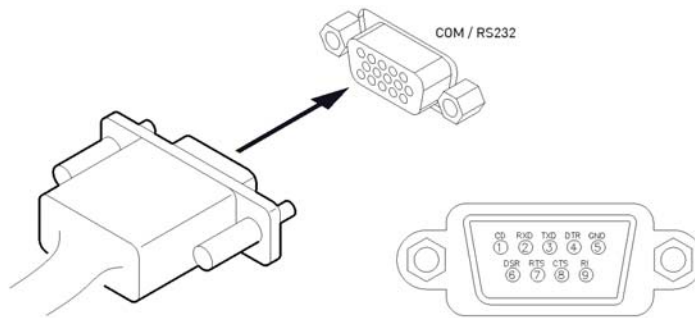

Like shown in the picture above, connect the COM1/RS232 (9pin D-Sub) and configure the Serial Connection and Text in the "Device" menu.

Serial (COM1) Setup:





- (1) Select "Device" in the OSD menu and move to this sub-menu by pressing [Enter].
- (2) Select COM1 and configure the name/type of the device.
- (3) Set up the value of Baud Rate/Parity/Stop bit/Data bit with the device.

**Text Setup:**

- (1) Select "Device" in the OSD menu, and move to this sub-menu by pressing [Enter].
- (2) Select "Text" and configure the relevant information.



**NOTE:**

Since an external device cannot be recognised before being configured in this menu, please ask your dealer for the correct data.

The USB port can be used for simple video copying (within 1 hour) to an USB memory device. It is recommended to use a device whose specifications are the same as below.

USB Spec.	Ver. 2.0
Device	USB Memory Stick, USB HDD
Voltage/electric current	Max. 200mA per DC 5V / Port

**NOTE:**

The USB device has to be formatted with FAT32 to be recognised by the DVR.

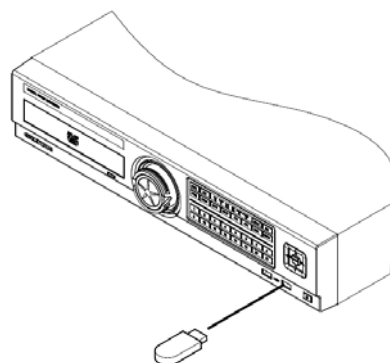

USB Storage for Copy



In the case of normal connection, if executing the Copy menu, the USB device will be automatically recognised as shown below. The detailed procedure to back up data is explained in chapter 7.3. Copy.

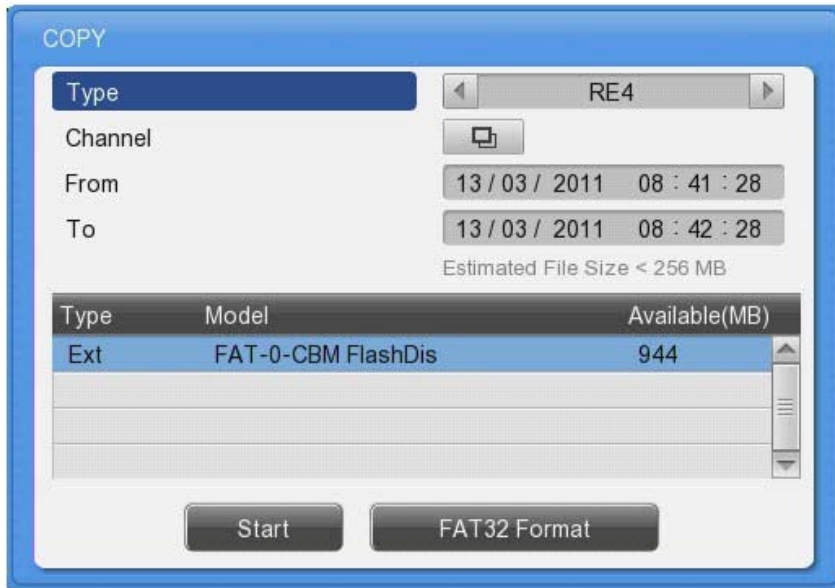

If the Video signal is looped through, the DVR notices this and sets the end resistance automatically. Please ensure the correct end resistance setting of the device connected to the video out signal.

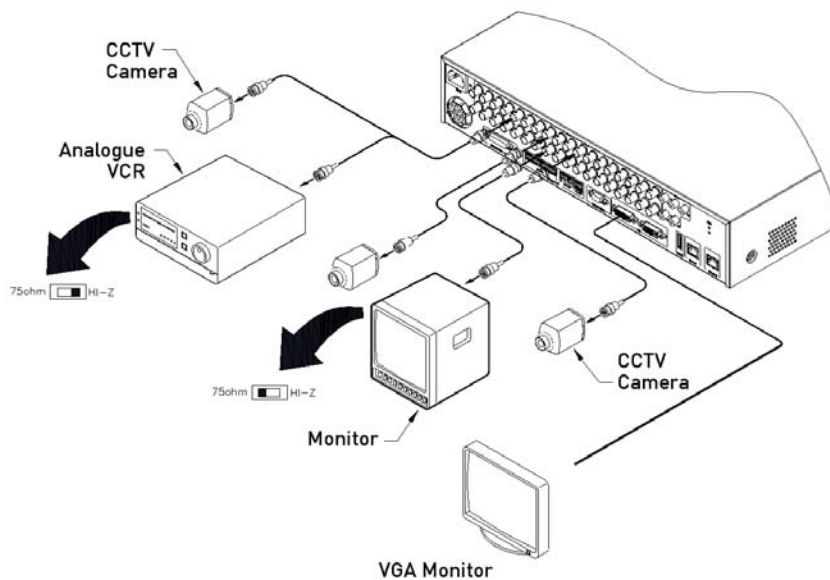

There are 4 RCA Audio Inputs and 1 RCA Output. The models GDV-B8832A and GDV-C4416A are also supplied with a 12 D-sub Audio input option.

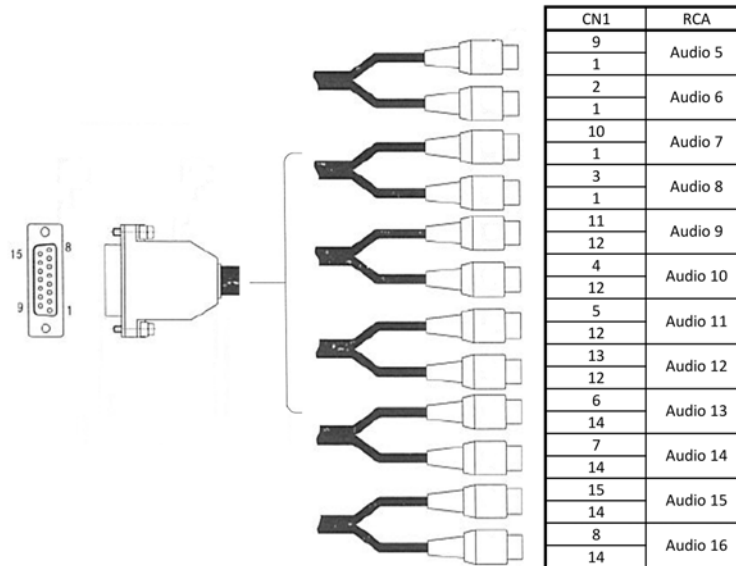
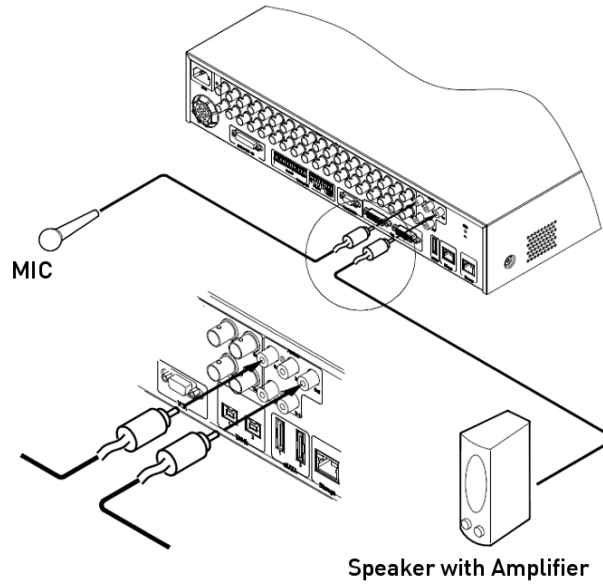

#### 4.4.4. HDD

Please refer to the following list for compliant HDDs:

Company	Model	Capacity
Western Digital	WD20EVDS-63T3B0	2TB
Western Digital	WD15EVDS-63T3B0	1.5TB
Western Digital	WD10EVDS	1TB
Western Digital	WD10EVCS	1TB
Western Digital	WD7500AAKS	750GB
Western Digital	WD5000AVVS	500GB
Western Digital	WD5000AVJS	500GB
Western Digital	WD2500AVJS	250GB

HDD registration and format:

After mounting HDD and booting the system, the “Disk Manager” will execute automatically. If not, please check the connectivity of HDD.

The Disk Manager is also available in the “System” menu under “Disk”.



- (1) Press the [Enter] button in “Disk Manager”.
- (2) Using the [▲/▼] buttons, select the new HDD (Displayed [No] on Enabled item) and press [Enter].
- (3) If you see the message for format, select [Yes].
- (4) Press [ESC] to exit the “Disk Manager”.

#### 4.4.5. Remote monitoring and controlling

Using the GRUNDIG Control Center Software, the DVR can be controlled and monitored over an internet/intranet connection.

Ethernet connection:

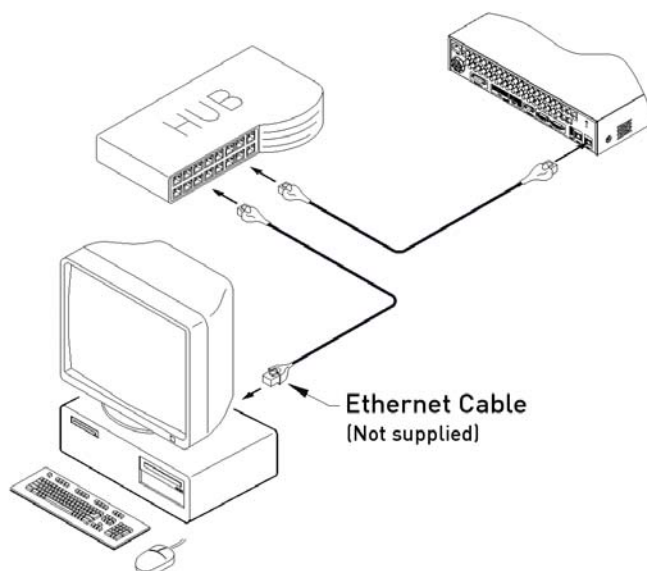

- (1) Cut the power off.
- (2) Connect the Ethernet cable to the DVR and the Hub/Switch.
- (3) Turn the power on.

Network configuration:

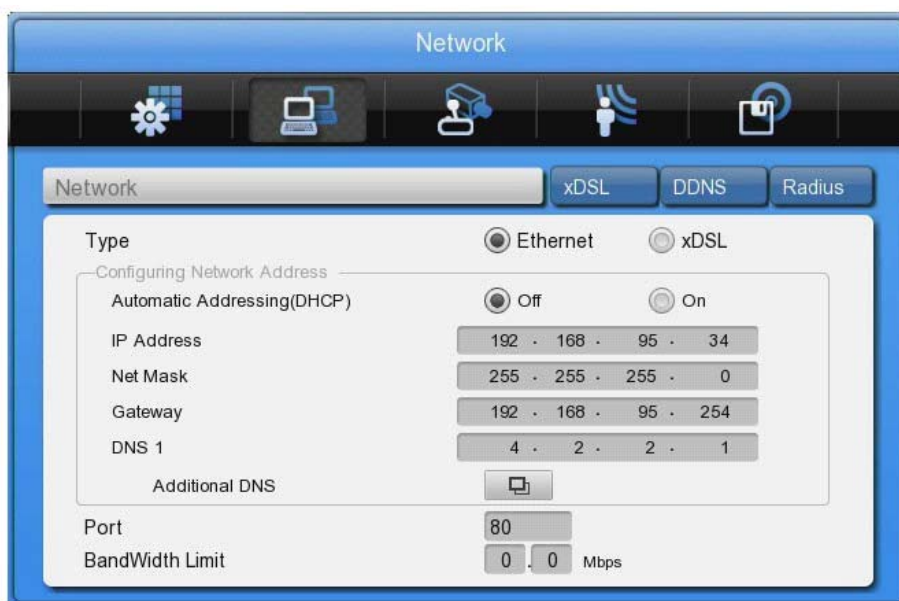

Ethernet:

Set Type as Ethernet and put in the IP Address, Net Mask, Gateway and DNS. The numbers can be changed by pressing the UP and DOWN direction keys or the scroll wheel of the mouse.

PPPoE:

First, change the Ethernet Port under Network settings to xDSL and then move to the xDSL menu. After this, just put in the ID and Password for your PPPoE connection. This data will be provided by your DSL provider.

DDNS:

Fill in the DDNS URL (GRUNDIG-ddns.eu) and the Group ID (g + the last 6 digits of the DVR's MAC address). Set the time interval with which the recorder should resend its IP information to the DDNS server.

---

## eSATA Device Connection:

You can connect almost any eSATA device to the DVR. The DVR does not supply power to the eSATA port; therefore only devices with their own external power supply can be used.

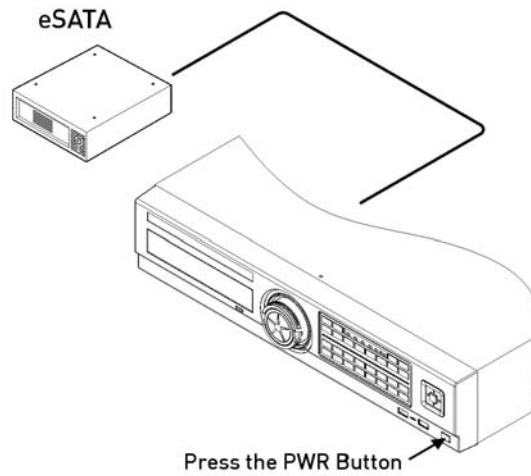

### NOTE:

The DVR will detect an eSATA connection, even though the DVR is already powered on. If not, it is recommended to connect an eSATA device as follows:

1. Power off the DVR.
2. Connect the external device to the eSATA interface.
3. Power on the external device.
4. Power on the DVR.

## 5. Menu Use

### 5.1. Menu Structure

The menu structure is shown in the image below. The settings for each menu are explained in the following chapters.

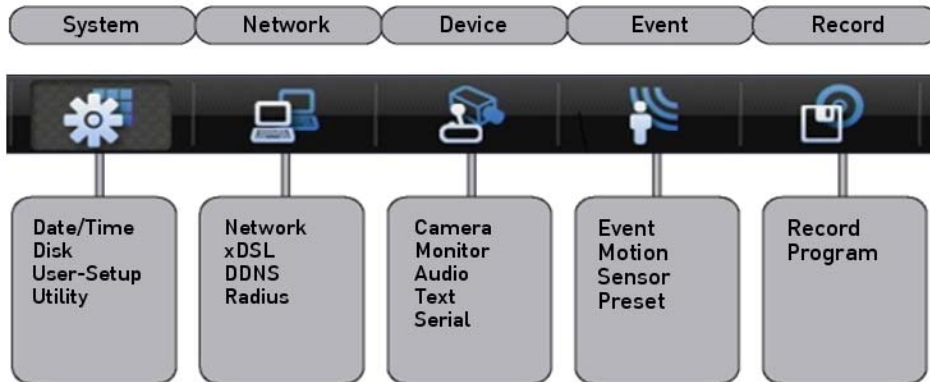

### 5.2. Function Menu

To execute the Function menu, click the right button of the mouse or select the 'FUNC' button on the front panel. The Function menu can be controlled by mouse or with the direction keys of the front panel. The function menu differs for Multi channel Mode, Single channel, Mode Monitor Mode and Playback Mode.

Please refer to the picture below for the Function menu structure.

Function Bar in Multi-Channel Mode:

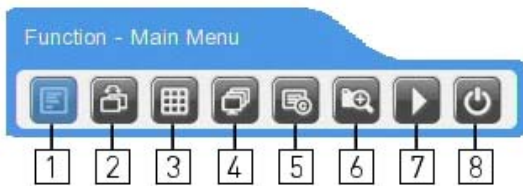

From left to right:

1. Access Main Menu
2. Switch Monitor
3. Select Multi Mode View
4. Start Sequence
5. BackuMenu
6. Search
7. Enter Playback Mode
8. Shutdown

Function Bar in Single Channel Mode:

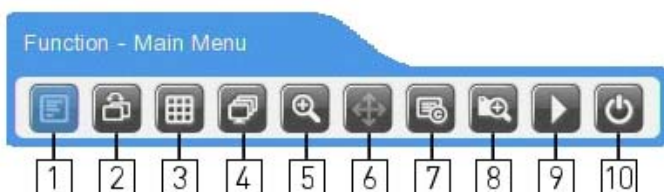

---

From left to right:

1. Access Main Menu
2. Switch Monitor
3. Select Multi Mode View
4. Start Sequence
5. Digital Zoom
6. PTZ Control
7. Backup Data
8. Enter Playback Mode
9. Shutdown

Function Bar in Playback Mode:

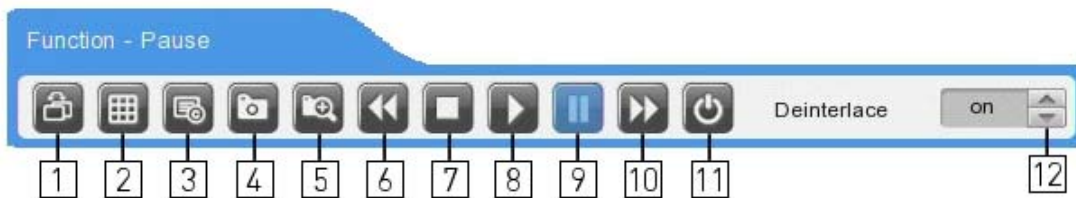

From left to right:

1. Switch Monitor
2. Select Multi Mode View
3. Backup Data
4. Take a Snapshot to an USB device (only active when video playback is paused)
5. Search
6. Fast Backward (press multiple times to change speed)
7. Stop Playback Mode
8. Play
9. Pause
10. Fast Forward (press multiple times to change speed)
11. Shutdown
12. Enable/Disable deinterlacing (only active when video playback is paused)

### 5.3. Factory Reset

In order to reset the system settings to factory default, go to System Setting->System->Setting, and press Factory Reset. Then a warning message will appear and after you confirmed with "Yes" the DVR will be set to factory default.

FACTORY DEFAULT

System:

Date/Time	Time Zone		UTC 00:00 Dublin
	Daylight Saving		Off
	NTP Function		Off
		Sync With NTP	Off
		NTP Mode	Client
		NTP Server Loc.	Public
		NTP Local Server IP	0.0.0.0
		Interval	1 (hour)
	Holiday Select		UTC 00:00 Dublin
	Date Format		No
	Time		MM/DD/YYYY
Disk	Overwrite(Auto Deletion)		On
	Block Playback		Off
	Disk Full Alarm Warning		50°C
	Disk Manager		>>
	Disk Status		>>
User Setup			Default Passwords
Utility	DVR Alias		DVR0
	DVR Keyboard ID		1
	Remote Controller ID		All
	Language		English
	Firmware Update		>>
	System Log		>>
	Factory Reset		>>

Network:

Network	Type		Ethernet
	DHCP		Off
	IP addr		Default IP
	Net Mask		Default Net Mask
	Gateway		Default Gateway
	DNS1		0.0.0.0
	Additional DNS		>>
	Port		80
	Band Width Limit (Mbps)		0.0
xDSL	User ID		Guest
	Password		*****
	Status		xDSL not connected
DDNS	Interval		Off
	URL		<a href="http://www.grundig-ddns.eu">www.grundig-ddns.eu</a>
	Group		Newbie
	Status		Not registered



Device:

Camera	Channel Number		Ch1	
	Name		Cam 1	
	Status		On	
	Type		NTSC	
	Colour		Colour	
	AGC		Enable	
	Brightness		0	
	Contrast		0	
	PTZ	PTZ Home		Off
		PTZ Idle Time		5
		PTZ Port		None
		PTZ Address		0
Monitor	Monitor			
	Alarm Pop-up (Sec)		Off	
	User Sequence Configuration		<<	
	SEQ Time (Sec)		5	
	Covert		>>	
	Multi Mode		4E, >>	
	VGA Mode		800x600@56Hz	
	Info Level		>>	
Audio	Audio Channel			
	Audio Recording			
	Audio Gain			
	Sync Video Channel			
	Audio Mix			
Text	Recording		Off	
	Sync Text With		Ch1	
	Device		Manual	
	Seek Header		Off	
	Header 1		Header1	
	Header 2		Header2	
	Delimiter		0D0A	
	Timeout(ms)		1000	
Lines		20		
Serial	Serial Port		Com1	
	Device		None	
	Interface		RS232	
	Baud Rate		9600	
	Parity Bit		None	
	Stop Bit		1	
	Data Bit		8	

Event:

Event	Event Check		Always
	Event Action		Relay 1
	Action Duration		10 Sec
	Normal Event Source		>>
	System Event Source		>>
Motion	MD		All
	Sensitivity		2
	Area		Set All
Sensor	Sensor		All, N.O.
Preset	Channel Number		Ch1
	Preset		Sensor 1, Preset1

Record:

Record	Record Mode		Manual & Event
	Program		Program A
	Event Duration		>>
	Playback Deinterlace		On

Program initial value

GDV-B2208A:

Record mode		Normal			Event		
Division		Res	Fps	Q	Res	Fps	Q
Program	A	4CIF	15	Q5	4CIF	15	Q5
	B	4CIF	7	Q5	4CIF	7	Q5
	C	4CIF	4	Q5	4CIF	4	Q5
	D	2CIF	30	Q5	2CIF	30	Q5
	E	2CIF	15	Q5	2CIF	15	Q5
	F	2CIF	7	Q5	2CIF	7	Q5
	G	CIF	30	Q5	CIF	30	Q5
	H	CIF	15	Q5	CIF	15	Q5
	I	CIF	7	Q5	CIF	7	Q5

GDV-A4416A:

Record mode		Normal			Event		
Division		Res	Fps	Q	Res	Fps	Q
Program	A	4CIF	7	Q5	4CIF	7	Q5
	B	4CIF	4	Q5	4CIF	4	Q5
	C	4CIF	2	Q5	4CIF	2	Q5
	D	2CIF	15	Q5	2CIF	15	Q5
	E	2CIF	7	Q5	2CIF	7	Q5
	F	2CIF	4	Q5	2CIF	4	Q5
	G	CIF	30	Q5	CIF	30	Q5
	H	CIF	15	Q5	CIF	15	Q5
	I	CIF	7	Q5	CIF	7	Q5

GDV-C4416A:

Record mode		Normal			Event		
Division		Res	Fps	Q	Res	Fps	Q
<b>Program</b>	<b>A</b>	4CIF	30	Q5	4CIF	30	Q5
	<b>B</b>	4CIF	15	Q5	4CIF	15	Q5
	<b>C</b>	4CIF	7	Q5	4CIF	7	Q5
	<b>D</b>	2CIF	30	Q5	2CIF	30	Q5
	<b>E</b>	2CIF	15	Q5	2CIF	15	Q5
	<b>F</b>	2CIF	7	Q5	2CIF	7	Q5
	<b>G</b>	CIF	30	Q5	CIF	30	Q5
	<b>H</b>	CIF	15	Q5	CIF	15	Q5
	<b>I</b>	CIF	7	Q5	CIF	7	Q5

GDV-B8832A:

Record mode		Normal			Event		
Division		Res	Fps	Q	Res	Fps	Q
<b>Program</b>	<b>A</b>	4CIF	12	Q5	4CIF	12	Q5
	<b>B</b>	4CIF	6	Q5	4CIF	6	Q5
	<b>C</b>	4CIF	3	Q5	4CIF	3	Q5
	<b>D</b>	2CIF	25	Q3	2CIF	25	Q3
	<b>E</b>	2CIF	12	Q3	2CIF	12	Q3
	<b>F</b>	2CIF	6	Q3	2CIF	6	Q3
	<b>G</b>	CIF	25	Q1	CIF	25	Q1
	<b>H</b>	CIF	12	Q1	CIF	12	Q1
	<b>I</b>	CIF	6	Q1	CIF	6	Q1

## 6. Monitoring

All analogue video image channels connected to the DVR are displayed on the screen after booting the DVR. It enables the user to utilise all monitoring modes of DVR. If only one monitor is connected to GDV-B8832A, the channels 17-32 can be viewed via the function Monitor Switching.

### 6.1. Basic Screen

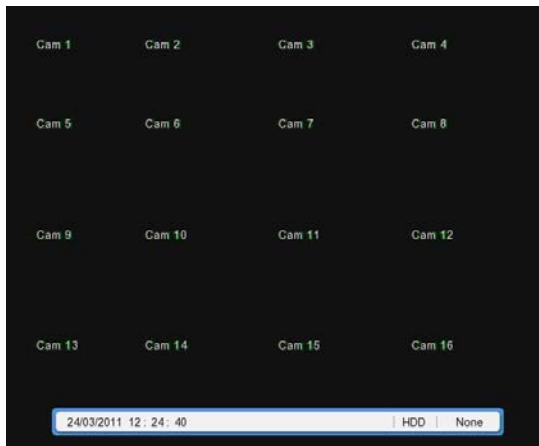

After the power connection is established, the DVR will boot automatically. After booting, 16 channel screens are displayed (For GDV-B8832A, GDV-C4416A, GDV-A4416A: 16 screens, for GDV-B2208A: 8 screens).

If a user password is set, the Password input window will be displayed.

### 6.2. Single Full Screen Mode

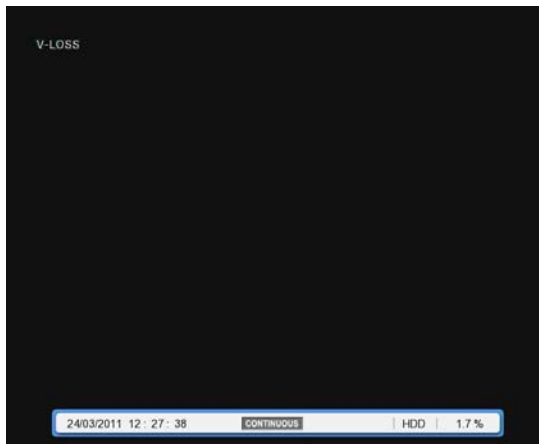

Press the wanted channel number or click with the mouse on the wanted channel. Press the [MULTI] button to return to the divisional screen.

### 6.3. Multi Screen Mode

Press [MULTI] for multi channel display or click the "Display" icon in the Function menu. Every time you press the [MULTI] button, the screen mode will change. For GDV-B8832A, GDV-C4416A and GDV-A4416A the modes are 1~4, 5~8, 9~12, 13~16, 4C, 1~9, 8~16, 1~10 and all 16 screens. For GDV-B2208A the modes are 1~4, 5~8, 4C and all 8 screens.

### 6.4. Screen Description

The status bar from the monitoring screen shows the DVR's current status which includes Date/Time, Record, Motion/Sensor Detection, Manual Record, Text Input and HDD's Record capacity.

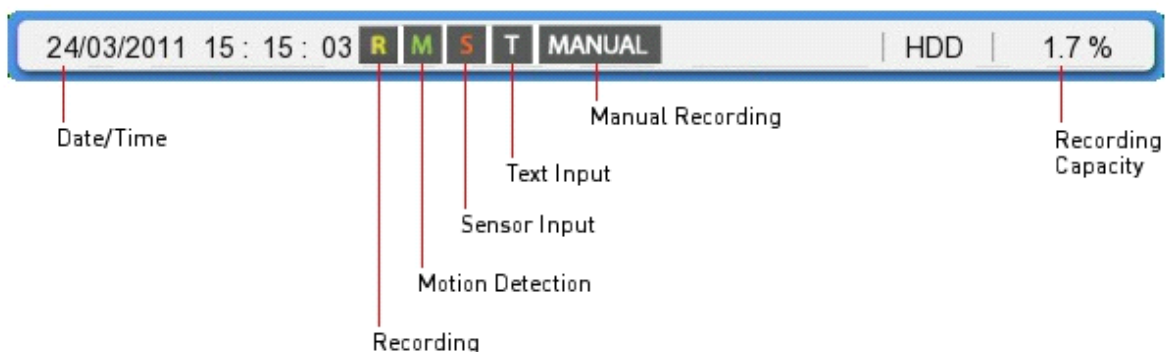

## 6.5. Sequence Mode

By pressing the [SEQ] button a user defined sequence will start switching between single channels and division views after a preconfigured time.

### 6.5.1. Sequence Mode Settings

The settings for the Sequence Function are configured under "Device" > "Monitor" in the OSD Menu.

Select "Seq. Switching (sec)" and set a value from 1 sec. to 60 sec. When OFF is set, the auto switch mode is disabled.



The user can define up to 16 sequence steps. As shown in the picture above, in the 16ch DVR the user can choose a channel from 1 to 16 or multichannel views for each sequence step. Respectively you can choose only from 8 channels with the 8 channel DVR and 32 channels with the 32 channel DVR. All models support up to 16 sequence steps.

## 6.6. Event Screen

When an event is detected, the green colour [M] and red colour [S] will be displayed in the status bar. If [M] is displayed, the camera name will be displayed in green colour, and it will turn back to yellow when Motion Detection ends. If [S] is displayed, the camera name will be displayed in red colour, and it will turn back to yellow when the Sensor Event ends.

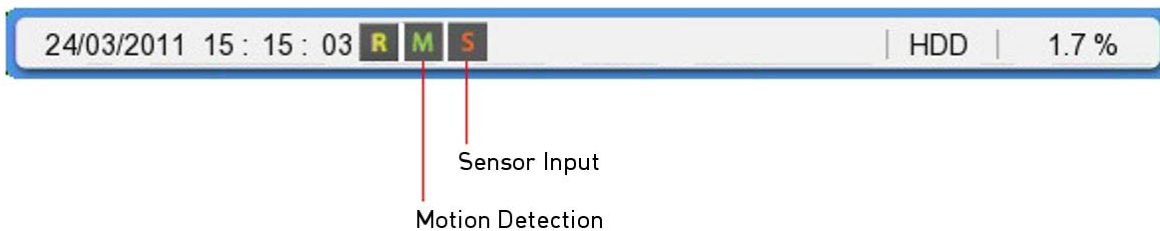

In the "Monitor" menu you can define an Alarm Pop-up time. If this is set, the DVR will display only the channels on which an event occurred. For example, when on 3 channels motion was detected, a 4 division screen will be displayed on the screen, including these 3 channels. Press any button to return to the original channel, or wait until the Alarm Pop-up time ends.



1. If Alarm Pop-up (sec) is set to Off, the Alarm Pop-up will not operate.
2. If Alarm Pop-up (sec) is set to Keep, it does not return to the previous screen until you press a button.

### 6.7. Zoom Screen Mode

- In the single full screen mode, press the [FUNC] button and the D-Zoom button, then use the [+] button to zoom in the image.
- The default zoom screen is located in a central position when pressing the [ZOOM] button. The Zoom image can be shifted to the left and right in 18 steps and from top to bottom in 12 steps.
- Use the direction keys to move the image selection.
- Press [-] to return to the original screen.



### 6.8. Pause Live Screen

- Press [PAUSE] to pause the live screen and press [PAUSE] again to return to live screen.

## 6.9. PTZ Control



Connect a PTZ controller to the DVR and set the relevant protocol in the “Serial Setup” menu, then the PTZ of the camera can be operated while live monitoring is activated. To pan and tilt a PTZ camera, use the direction keys from the DVR’s front panel or the mouse. You can access focus, zoom and presets of the PTZ camera by pressing the PTZ button on the DVR’s front panel or clicking on the PTZ icon in the Function menu.

Below you find a list of supported protocols.

Model	Manufacturer
BOSCH AutoDome, TC8560X-4	Bosch
PELCO(P), PELCO(D)	Pelco
Sony EVI-D3x	Sony
VT VPT-4x	VT
AD SpeedDome	AD
SungJin SJ372R1	SungJin
Samsung SCC641	Samsung Electronics
Panasonic WV-CS850	Panasonic
SDZ160/330, Samsung SPD, Keyboard SCC3000A, Samsung SRX-100B	Samsung Techwin
LG GAC-PT2	LG
Merit-Lilin FastDome	Merit
Elmo PTC200C	Elmo
Canon VC-C4	Canon
HTC-230S	DongYang Unitech
RVision	RVision
Elbex	Elbex
Honeywell 755/655, HRX-2000, HTX-3000, ScanDome2	Honeywell
VIDO	VIDO
VICON	Vicon
Hunt	Hunt
ORX-1000	Sysmenia
Fine CRR-1600	LiveEye
Tokina	Tokina
Kodicom KRE	Kodicom
Nuvico	Nuvico

- 
- Press the button of the desired channel, or select the channel with the mouse.
  - Press the PTZ button from the front panel or click on the PTZ icon in the Function menu with the mouse.
  - The PTZ menu (Zoom/Focus, Load Preset, Save Preset) will appear.
  - Then press the [Enter] button or click on the mouse.

#### **6.9.1. Pan/Tilt**

This menu is used to control the Pan & Tilt function in real-time monitoring mode.

- Control Pan/Tilt through the direction keys on the front of the DVR or click with the mouse to center this position.

#### **6.9.2. Zoom/Focus**

This menu is used to control the Zoom & Focus function in real-time monitoring mode.

- Select Z/F (Zoom/Focus) from the PTZ mode.
- Control Zoom/Focus through the direction keys on front of the DVR or use the scroll wheel of the mouse.

#### **6.9.3. Loading Preset**

This menu is used to move the PTZ camera into a Preset position during real-time monitoring mode.

- Use the Up / Down buttons or the mouse wheel to select the Preset Number.
- Once Preset is configured, please select [Load] and then press [Enter].

#### **6.9.4. Save Preset**

This menu is used to set a new Preset position during real-time monitoring mode.

- Control the PTZ camera location by using the 'Pan/Tilt' menu and the 'Zoom/Focus' menu.
- Use the Up / Down buttons or the mouse wheel to select the Preset Number.
- Once the preset position is configured, select [Save] and then press [Enter].

#### **6.9.5. Auxiliary On**

This menu is used to utilize specific functions of a PTZ device during real-time monitoring mode.

- Use the Up / Down buttons or the mouse wheel to select the Aux Number.
- Select the relevant Number button for this specific function (Up to 16 functions of the PTZ camera can be controlled with the Aux Function.)

#### **6.9.6. Auxiliary Off**

This menu is used to stop operation of a specific function of the PTZ device.

- Use the Up / Down buttons or the mouse wheel to select the Aux Number.
- Select Off and press the [Enter] button or click on the mouse.

#### **6.9.7. Menu**

With this function you can connect to the PTZ camera's menu. Use the Up/Down/Left/Right and the Enter key on the front panel of the DVR to adjust settings in the menu, and press the [ESC] button to exit the menu.



---

## 7. Playback

### 7.1. Playback Mode

#### 7.1.1. Playback on Standard monitor (16 / 9 / 4 division)

- Please press the [PLAY] button in monitoring mode or click the [PLAY] button in the Function menu with the mouse.
- When pressing the [PLAY] button or the [FWD] button, the video plays in forward direction at 1× speed.
- When pressing the [REW] button, the video plays backwards at 1× speed.
- When pressing the Playback button in a multi-division monitor mode, it plays the recorded data for all viewable channels.

#### 7.1.2. Playback function

##### PLAY:

Playback 1× speed Multichannel video will play when pressing the [PLAY] button in Multichannel monitor mode.

##### PAUSE:

Pause the video temporarily.

##### STOP:

Stops the Playback and the DVR returns to live view.

##### FWD:

Playback speed will be changed (x1, x2, x4, x8, x16, x32, x64, x1/2, x1, x2, x4 – in order). When pressing the [FWD] button in live view mode, the DVR plays back the recorded video from 1 minute ago. Playback speed can be changed by pressing the [FWD] button.

##### REW:

Reverse playback speed will be changed (x1, x2, x4, x8, x16, x32, x64, x1/2, x1, x2, x4 - in order). When pushing the [REW] button in the live view mode, the DVR plays back the video from 1 minute ago. Playback speed can be changed by pressing the [REW] button.

##### STEP FORWARD:

When pressing the [FWD] button while playback is paused, the video will jump to the next frame. Press [PLAY] to return to normal playback mode.

##### STEP REWIND:

When pressing the [REW] button while the playback is paused, the video will jump to the previous frame. Push [PLAY] to return to normal playback.

##### 1/2 REWIND:

Plays at half speed in reverse direction.

##### 1/2 FORWARD:

Plays at half speed in forward direction.

##### Jog Dial:

The Jog Dial can be used to control the video playback. The outer wheel controls the speed of the playback. The inner wheel can be used to control the Fast-forward function and the Rewind function.

---

## 7.2. Search Mode

The DVR supports 4 different modes to search for video material (Time, Calendar, Event, Thumbnail). Press the [SEAR] button on the front panel or the search icon in the Function menu to access the Search menu.



### 7.2.1. Time Search

Start-REC Time:

The date and time of the first recording

End-REC Time:

The date and time of the last recording

Search Time:

Select the date and time to play back

Search :

Start the search

Select the date and time to search for. After pressing the [SEARCH] button the video will play back at the requested position.

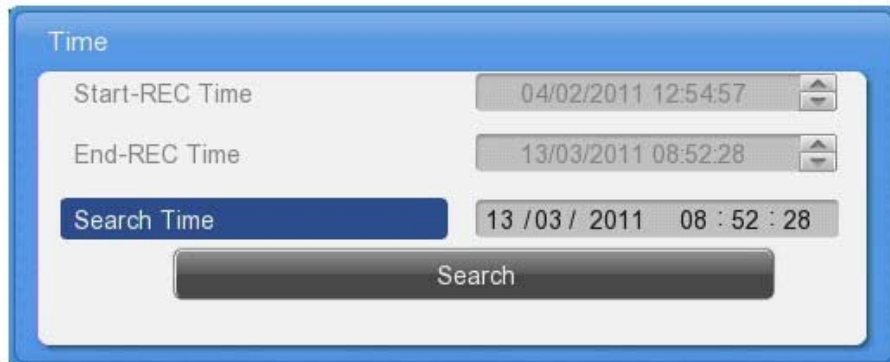

## 7.2.2. Calendar Search

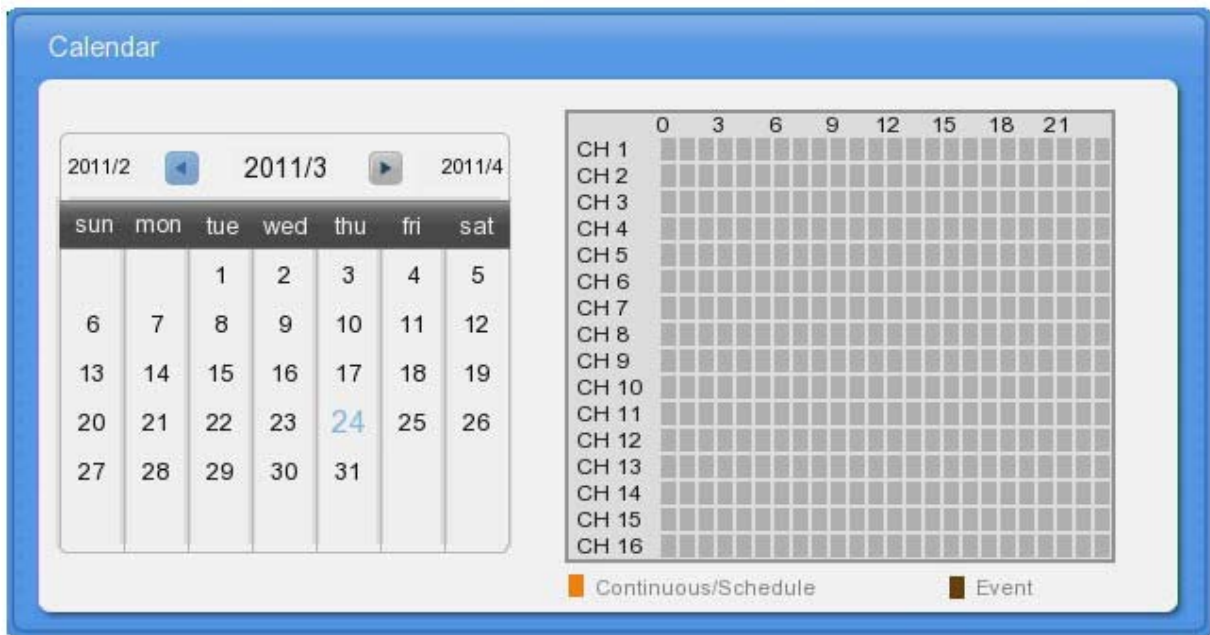

Year:

Select the Year to search for. Use the direction keys or the scroll wheel of the mouse to change it.

Month:

Select the Month to search for. Use the direction keys or the scroll wheel of the mouse to change it.

Date:

Select the Date to search for. Use the direction keys or the scroll wheel of the mouse to change it.

Time:

Select the time and push the [Enter] button or use the scroll wheel to start the video.

NOTE: The orange markings represent the recorded videos. The dark orange markings represent an occurred event.

---

### 7.2.3. Event Search

The user can search all channels or only one channel. He can decide to search for all events or only for motion detections or sensor alarms. The user can select a start time and end time within he wants to search. The results will be displayed in an additional window. Select the result you want to play back and push [Enter] or scroll the mouse. The video will play back at the desired position.

The screenshot shows a software interface for searching events. It features a blue-bordered window titled "Event". Inside, there are several input fields and dropdown menus. The "Start-REC Time" field shows "04/02/2011 12:54:57". The "End-REC Time" field shows "13/03/2011 08:52:28". The "Search Start Time" field shows "13 / 03 / 2011 07 : 52 : 28". The "Search End Time" field shows "13 / 03 / 2011 08 : 52 : 28". There are two dropdown menus: "Event Channel" and "Event Type", both currently set to "All". A large "Search" button is located at the bottom of the window.

Start-REC Time:

Starting date and time of the first recording

End-REC Time:

The date and time of the last recording

Search Start Time:

Input the start date and time for search with the direction buttons, press [Enter] and change the value with the Up / Down buttons. With the mouse, click and scroll the wheel.

Search End Time:

Input the end date and time for search with the direction buttons, press [Enter] and change the value with the Up / Down buttons. With the mouse, click and scroll the wheel.

Event Channel:

Select the channel for the search:

- GDV- B8832A: from Ch1 to Ch32
- GDV-A4416A & GDV-C4416A: from Ch1 to Ch16
- GDV-B2208A: from Ch1 to Ch8

Event Type:

Select the event type for the search. Choose between:

ALL, MD, SENSOR, V- LOSS, TEXT

---

### 7.2.4. Thumbnail Search

Use this search mode to search by thumbnail preview pictures. Select the channel, date and time and the time interval to create 16 thumbnails of the video.



Channel:

Select the channel and change the value with the direction keys or the mouse wheel.

Start Time:

Input the date and time for the starting point and change the value using the Up / Down direction keys or the mouse wheel.

Interval:

Set the interval value using the Up / Down direction keys or the mouse wheel.

View video:

When pressing the [Search] button, 16 thumbnail previews will be shown based on the start time and interval. Press [FUNC] to return to the search or use the mouse wheel.

Select video:

Use the direction keys to move the blue selection frame and press the [Enter] button to start playback.

Alternatively, select a thumbnail with the left mouse button and start the playback with an additional mouse click.

### 7.3. Copy

The Copy function is used to back up video material on USB devices or CD/DVDs. For USB devices you can select between the RE4 (multichannel) and AVI (only 1 channel) video format and store it on a FAT32 formatted device. In the user authorisation you can define which user has the right to back up the video. For this please refer to chapter 8.1.3. User Setup.

To use the copy function, press [COPY] or click the Copy button in the Function menu.

---

### 7.3.1. CD/DVD

This is the copy function if you use a recordable CD or a DVD. Please insert the recordable CD or DVD first before you start the backup menu. The CD or DVD will be automatically detected.



**Type:**  
Select CD/DVD by using the direction keys or the mouse wheel.

**Channel:**  
In a pop-up window the user can select some or all channels to be backed up. Enter or use the mouse wheel to access the channel selector.

**From:**  
Select the start date and time to copy using the Up / Down direction keys or the mouse scroll wheel.

**To:**  
Select the end date and time to copy using the Up / Down direction keys or the mouse scroll wheel.

**Select Disk:**  
Select the media to copy using the [Enter] button on Select Disk.

**Start:**  
Starts to copy. Press the [Start] button with [Enter] or click with the left button of the mouse.

Please refer to the supported media list below.

DVD-R manufacturer (DVD+R is not supported):

- Mitsubishi (×16 recommended)
- TDK (×16 recommended)
- Imation (×16 recommended)
- Sony (×16 recommended)

CD-R Manufacturer:

- Mitsubishi (×52 recommended)
- TDK (×52 recommended)
- Imation (×52 recommended)
- Sony (×48 recommended)

### 7.3.2. RE4



The RE4 format can be backed up on external HDDs and USB Flash drives. Together with the video a Mini player will be copied to the Storage device to be able to view the RE4 format. You can also open the RE4 file with the GRUNDIG Control Center.

Select the channel you want to record and press [Enter] or use the mouse to open the channel selector as shown below.

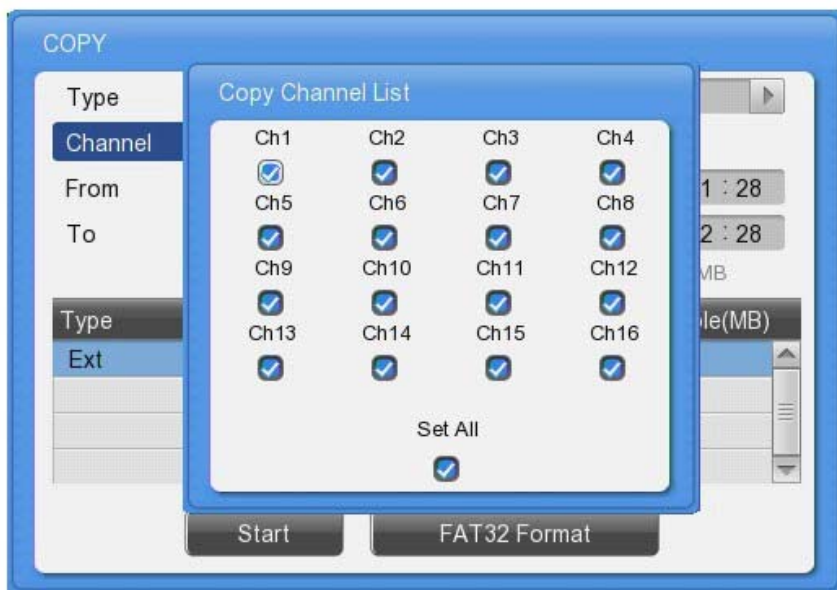

Type:

Select RE4 using the direction keys or the mouse wheel.

Channel:

To pop up the channel selection window, press [Enter] or use the mouse.

Select Channel:

The user can select some or all channels. After selecting the channel, press [Enter] or click the left button of the mouse.

Start time:

Set the start date or time to copy. Use the direction keys or the mouse wheel to change the values.

End time:

Set the end date or time to copy. Use the direction keys or the mouse wheel to change the values.

---

Select disk:

Select the media you want to copy to. Press [Enter] on the Disk list or click the mouse.

Start:

Starts the backup. Press [Enter] or click the mouse.

NOTE: If the backup is interrupted, the backup files will not be playable on a PC.

### 7.3.3. AVI

In the AVI format the user can back up a single channel video. Together with the video file the System and Event log of the selected time frame will be copied to the external storage.



Type:

Select AVI using the direction keys or the mouse wheel.

Channel:

Select the channel to copy with the direction keys or the mouse wheel.

From:

Set the start date and time you want to back up. Use the direction keys or the mouse wheel to change the values.

Duration:

Set the copy length. Use the direction keys or the mouse wheel to change the duration you want to back up.

Start:

Starts the backup. Press [Enter] or click the mouse.

Select disk:

Select the media on which you want to back up the AVI file. Press [Enter] and select the media or click the mouse.



---

## 8. Configuration

### 8.1. System Setup

Time, Disk and Authority settings and miscellaneous settings can be configured here.

#### 8.1.1. Date/Time

The Date and Time setting should be configured prior to any recording.



The Time configuration is very important to protect the recording data. Changing the time during recording is not recommended. The factory default setting for the time is "UTC 00:00 Dublin".

Time Setup:

Caution: While recording, changing the system time will affect a time change for all previously recorded video data. Therefore, we recommend to back up the recorded video before changing the system time.

- Press "Main Menu" in the Function menu or the [MENU] button on the front panel.
- Select the "System" menu.
- Select "Date/Time" in the System menu. The Date/Time configuration will be opened.
- Use the directional keys or the mouse to change the values.

Time zone:

Use the Left / Right direction keys or the mouse wheel. To return to the previous menu, press [ESC] or click the right mouse button.

Daylight saving:

This menu is synchronised with the time zone configuration menu. When a daylight saving area is set, this function is activated. The daylight saving applicable area is working in conformity with the time zone of Microsoft Windows.

Date format:

Change the date format between "MM/DD/YYYY", "YYYY/MM/DD" and "DD/MM/YYYY" by using the Left / Right direction keys or the mouse wheel.

Time:

With the Left / Right direction keys, you can move to year, month, day, hour in order. Each configuration can be changed with the Up / Down direction keys or the mouse wheel.

Apply:

When pushing the "Apply Date/Time" button, you will see the message box shown below.



NOTE:

Except for the "Date/Time" configuration, all configurations are saved automatically. The "Date/Time" configuration can have a critical effect on the HDD recording file system, therefore the user has to confirm these changes. Press "Yes" if you want to confirm or press "No" and return to the previous menu.

NTP Setup:

The NTP (Network Time Protocol) synchronises the time of all connected devices. The DVR can be set to client mode or server mode or to both modes at the same time.

Sync with NTP:

Enable or disable the NTP function.

NTP Mode:

Configure the NTP mode of the DVR – Client / Server / Both



Caution: When using the NTP client mode, the user must set the NTP to On.

NTP Server Loc.:

If the DVR is in client NTP mode, this function is enabled. Configure the IP address of a local network NTP server or select "Public" if the NTP server is a public one.

NTP Local server IP:

Input the IP address of the local NTP server or a DVR that is working in NTP server mode.

Interval:

Configure the interval of the time synchronisation.

### 8.1.2. Disk

In the "Disk" menu everything regarding the hard disk of the DVR can be configured.

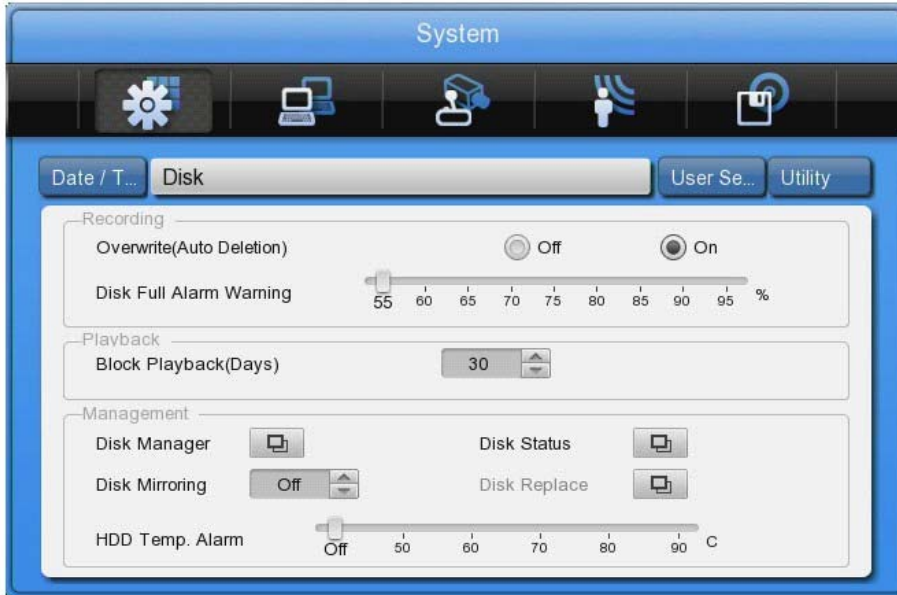

Overwrite (Auto Deletion):

If there is no space left in the HDD, old data will be overwritten automatically.

Disk Full Alarm Warning:

If the mounted Disk has reached the selected percentage, an alarm warning will be send to the user.

Block Playback:

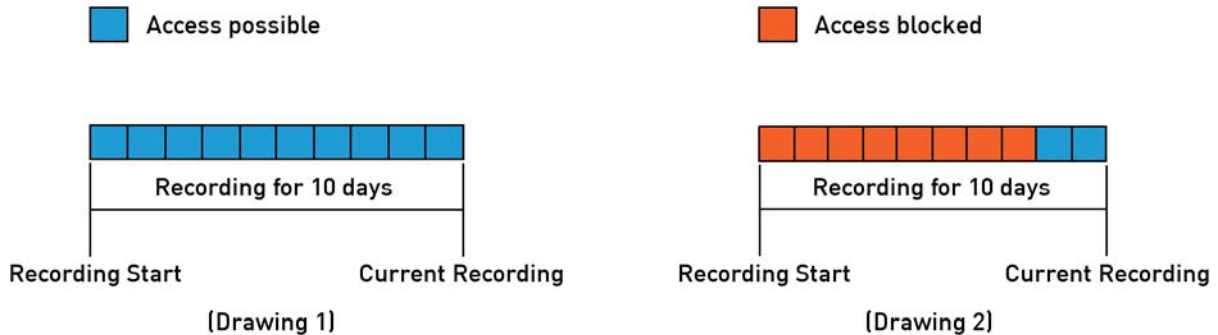

The Block Playback function can be used to decline access to recorded video material. If the Block Playback is set to 2 days, only the last 2 days can be seen and backed up with the recorder. Everything before these 2 days cannot be accessed.

## Disk Manager:

“Disk Manager” is the menu for the management of internal or external HDDs (hard disk drives). You can see the type, name, the bad block status and the size of the HDD in this menu. You can also select if the HDD is enabled for recording or not.



NOTE: If you enable a HDD to record, you will be asked whether the HDD should be formatted.

### Type:

Displays the location or type of disk ( Int A (Internal A HDD), Int B (Internal B HDD), Ext (External HDD) ).

### Model:

HDD model name

### Bad Blk:

Displays the number of bad blocks of the HDD.

### Size:

Displays the HDD size in MB.

### Enabled:

Enables a HDD for recording (“Yes”: Enabled / “No”: Disabled).

To enable a HDD, select it and change the status from NO to YES, by either pressing the “Enter” button on the front panel or changing it with the mouse wheel.

The following request window will pop up:

Caution: This Disk can be added without format. Nevertheless, do you want to format this disk?

- If you select NO, the HDD will not be formatted.

NOTE: If the HDD was already used in a GRUNDIG DVR and was formatted correctly, it will be available for recording even if you selected NO. All previously recorded videos will be also available.

- If you select YES, all data on the HDD will be erased and the HDD will be used for recording.

If you set the HDD status to NO, a window will pop up:

Disk will be removed.

- If you select YES, the message “Recording disk removed” will appear at the bottom of the screen and the status of the HDD is set to NO. The HDD will not be used for recording.

- If you select NO, the HDD will be used without any change and the message “Disk reused for recording” will appear at the bottom of the screen.

---

## Disk Status:

In the "Disk Status" menu you can check the temperature and status of the installed HDDs.

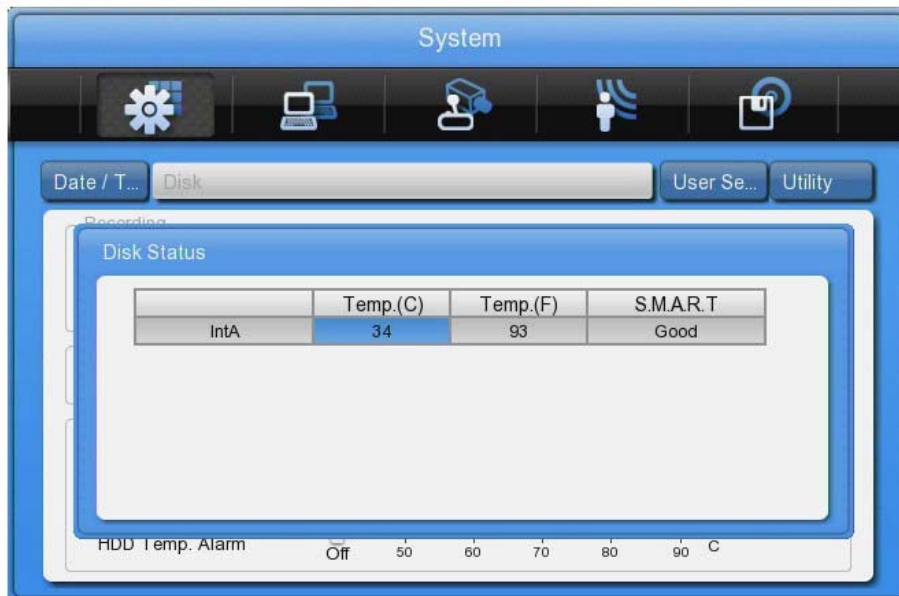

## Mirroring (only GDV-C4416A & GDV-B8832A):

In the mirroring option you can activate the RAID function. You can choose between three options. You need to use identical HDDs to activate this option and ensure a flawless working condition.

- DVR: The HDDs inside the DVR will be connected as one RAID (Redundant Array of Independent / Inexpensive Disks). Please note that HDD1 and HDD3 will form one pair and HDD2 and HDD4 another pair.
- NAS: If you have attached a Network storage device, it can be set up to mirror its data here.
- Both: All HDDs inside the DVR and inside the network storage will be mirrored.

Please note that you need to disable all HDDs before you can activate the mirroring. All HDDs also need to be formatted.

After you have activated the mirroring the mirror HDD will be shown with an (M) at the end of its name. To format both HDDs you need only to format the partner HDD.

### 8.1.3. User Setup

In the "User Setup" menu the authority of the administrator and of up to 10 users can be configured. "X" means NO and "O" means YES.

#### Check:

In the Check column you can define if a password input is necessary to access the marked function. If Check is set to "X", all users can access the function without putting in a password.

If Check is set to "O" only users that are also set to "O" can access the function after they entered their password.

For example, as you can see in the picture shown below, User 1 is not allowed to use the PTZ functions or to use the playback functionality or to turn on the DVR. User 2 is not allowed to access the menu, or to access the playback function or to turn off the DVR.

	Check	Admin	User											
			1	2	3	4	5	6	7	8	9	10		
Change P/W		<input type="checkbox"/>	<input type="checkbox"/>	<input type="checkbox"/>	<input type="checkbox"/>	<input type="checkbox"/>	<input type="checkbox"/>	<input type="checkbox"/>	<input type="checkbox"/>	<input type="checkbox"/>	<input type="checkbox"/>	<input type="checkbox"/>	<input type="checkbox"/>	<input type="checkbox"/>
Menu	<input type="radio"/>	<input type="checkbox"/>	<input type="checkbox"/>	<input checked="" type="checkbox"/>	<input type="checkbox"/>	<input type="checkbox"/>	<input type="checkbox"/>	<input type="checkbox"/>	<input type="checkbox"/>	<input type="checkbox"/>	<input type="checkbox"/>	<input type="checkbox"/>	<input type="checkbox"/>	<input type="checkbox"/>
PTZ	<input type="radio"/>	<input type="checkbox"/>	<input checked="" type="checkbox"/>	<input type="checkbox"/>	<input type="checkbox"/>	<input type="checkbox"/>	<input type="checkbox"/>	<input type="checkbox"/>	<input type="checkbox"/>	<input type="checkbox"/>	<input type="checkbox"/>	<input type="checkbox"/>	<input type="checkbox"/>	<input type="checkbox"/>
Relay	<input checked="" type="checkbox"/>	<input type="checkbox"/>	<input type="checkbox"/>	<input type="checkbox"/>	<input type="checkbox"/>	<input type="checkbox"/>	<input type="checkbox"/>	<input type="checkbox"/>	<input type="checkbox"/>	<input type="checkbox"/>	<input type="checkbox"/>	<input type="checkbox"/>	<input type="checkbox"/>	<input type="checkbox"/>
Playback	<input type="radio"/>	<input type="checkbox"/>	<input checked="" type="checkbox"/>	<input checked="" type="checkbox"/>	<input type="checkbox"/>	<input type="checkbox"/>	<input type="checkbox"/>	<input type="checkbox"/>	<input type="checkbox"/>	<input type="checkbox"/>	<input type="checkbox"/>	<input type="checkbox"/>	<input type="checkbox"/>	<input type="checkbox"/>
Power Off	<input type="radio"/>	<input type="checkbox"/>	<input type="checkbox"/>	<input checked="" type="checkbox"/>	<input type="checkbox"/>	<input type="checkbox"/>	<input type="checkbox"/>	<input type="checkbox"/>	<input type="checkbox"/>	<input type="checkbox"/>	<input type="checkbox"/>	<input type="checkbox"/>	<input type="checkbox"/>	<input type="checkbox"/>
Power On	<input type="radio"/>	<input type="checkbox"/>	<input checked="" type="checkbox"/>	<input type="checkbox"/>	<input type="checkbox"/>	<input type="checkbox"/>	<input type="checkbox"/>	<input type="checkbox"/>	<input type="checkbox"/>	<input type="checkbox"/>	<input type="checkbox"/>	<input type="checkbox"/>	<input type="checkbox"/>	<input type="checkbox"/>
Copy	<input type="radio"/>	<input type="checkbox"/>	<input type="checkbox"/>	<input type="checkbox"/>	<input type="checkbox"/>	<input type="checkbox"/>	<input type="checkbox"/>	<input type="checkbox"/>	<input type="checkbox"/>	<input type="checkbox"/>	<input type="checkbox"/>	<input type="checkbox"/>	<input type="checkbox"/>	<input type="checkbox"/>
N/MIC	<input checked="" type="checkbox"/>	<input type="checkbox"/>	<input type="checkbox"/>	<input type="checkbox"/>	<input type="checkbox"/>	<input type="checkbox"/>	<input type="checkbox"/>	<input type="checkbox"/>	<input type="checkbox"/>	<input type="checkbox"/>	<input type="checkbox"/>	<input type="checkbox"/>	<input type="checkbox"/>	<input type="checkbox"/>

If the Check button is set to "0", you need to put in your password before you get access to the desired function. See the picture:

MENU CHECK

User: admin

Password: [Empty]

NOTE:  
The Admin Password is "1234" in factory default. For user 1 to 10 the password is (in order) "1111", "2222", ... and for user 10 it is "0000".

Change the Password:

Change Password

New Password: [Input Field]

Re-enter Password: [Input Field]

Change



Select Change P/W for the user whose password should be changed. The password input box will be displayed. The password can be set with the direction keys on the front of the DVR or the mouse in the text input window. The password can be up to 8 digits long. To ensure you did not misspell the password you have to enter the password twice. Press "Change" when the password is finished. After that, a message window will be shown and you have to confirm the password change.



#### 8.1.4. Utility

Configure the name of the DVR, the remote control ID and Language.



#### DVR Alias:

Set the name of the DVR. This name will be shown when accessing the DVR via a network.

#### DVR Keyboard ID:

This menu is for setting the address of the keyboard when using all functions of the DVR with the keyboard. Factory default is "1". If the user wants to control various DVRs with one keyboard, each address should be set with a different value.

---

Remote Controller ID:

Maximally 16 remote control IDs can be set. One remote control can be used to manage all the 16 DVRs.

Registration order for the remote control:

1. Make the remote control point in the direction of the DVR.
2. Press the ID button several times to match the ID of the remote control to the DVR.
3. If the IDs are matched correctly, the DVR buzzes.
4. Now you can use the remote control.

Language:

Select the language you would like to use.

Firmware Update:

You can update the firmware by a USB Memory device.

- Insert a USB memory device including the firmware file to the USB port.
- Press the Firmware Update button.
- Select [YES] in the pop-up window.

NOTE: Only the administrator is allowed to perform a Firmware Update.



- The system will reboot.
- Firmware update is done.



### System Log:

The system log shows the boot status of the system and any changes regarding users and the DVR configuration.

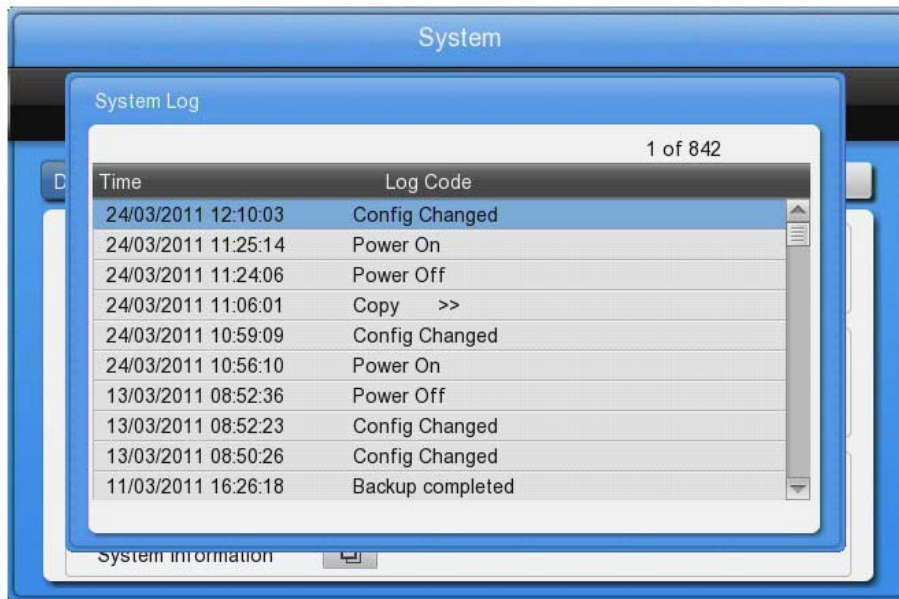

### Factory Reset:

Set all configurations back to factory default.



NOTE: Only the administrator is allowed to perform a factory reset.

### System Information:

The System information contains 2 pages of information about the system. The first page shows you the current data amount used for the single channels. On the second page you will see all the relevant system information like firmware and model type.

## 8.2. Network

This is the menu for configuring the network.

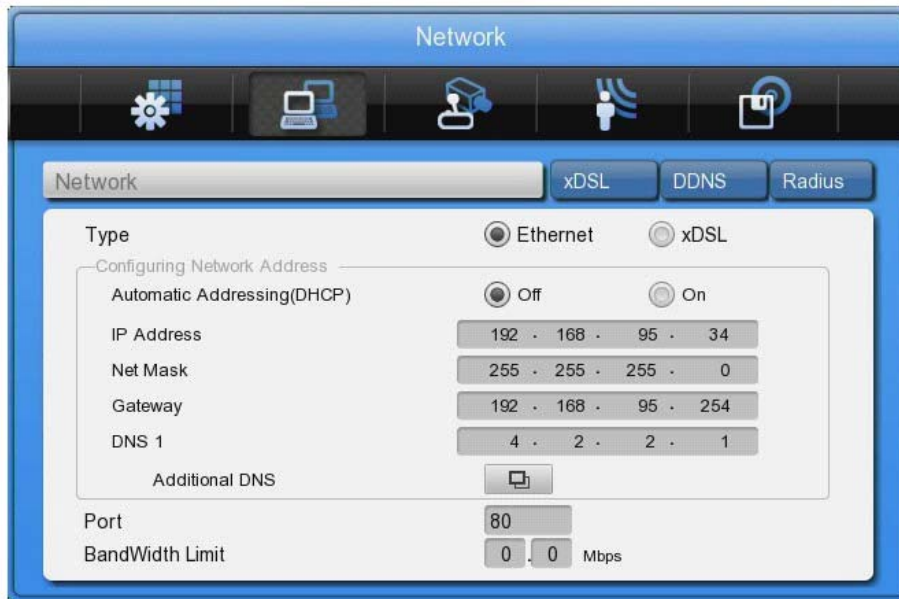

### Type:

Configure the type of Network (Ethernet/xDSL) connection. If the DVR is connected to a local network, you can change the configuration directly in the fields below. If the DVR is connected by xDSL (PPPoE), please make the configuration in the xDSL submenu.

### DHCP:

With DHCP (Dynamic Host Configuration Protocol), all hosts connected to LAN can get a temporary IP address from a DHCP server.

If the LAN has an active DHCP server, this server allocates the IP address directly to the DVR.

If there is no DHCP server in the network, the IP address needs to be configured manually.

### IP Addr:

The IP Address is for connection between the DVR and the Control Center and also for the web connection with the WebViewer (Net Mask and Gateway need to be configured if you want to access the DVR over the Internet.)

### Net Mask:

The Net Mask determines the range of the IP addresses which are available for use. You should receive the correct data from the network administrator.

### Gateway:

The Gateway is necessary for different types of network connections. You should receive the correct data from the network administrator.

### DNS 1:

DNS 1 is a network service used to rename IP addresses (Domain Name Server) and it should be received from the network administrator.

### Additional DNS:

The additional DNS can be used as an alternative when DNS 1 has a problem.

### Port:

The port is necessary for the connection to the Control Center Software and the WebViewer. The factory default setting is Port 80.

### Bandwidth:

In this menu the bandwidth used for video transmission can be limited. Contact the network administrator for further information on bandwidth limitation.

### 8.2.1. xDSL

The DVR can be connected directly to an xDSL modem and use a PPPoE connection for direct access to the Internet. If you are using this, please change the connection type to xDSL and configure the user ID and Password.

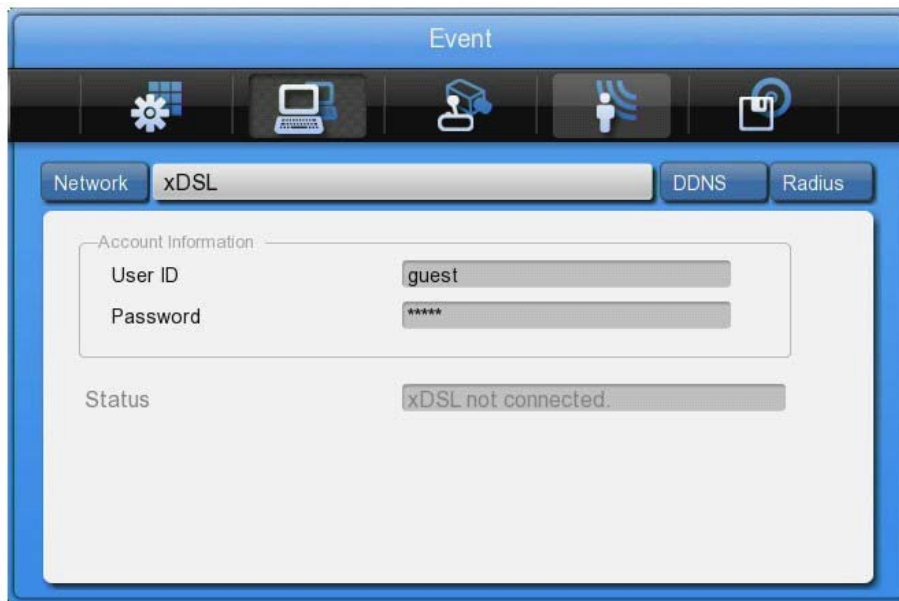

User ID/Password:

Fill in the user ID and Password.

Status:

Displays the connection status of the DVR.

### 8.2.2. DDNS

If the DVR is connected to a Cable modem or a xDSL modem, the IP address will be changed with every connection to ISP. To connect to the DVR over the Internet you need to know this IP address. GRUNDIG supplies a DDN Server that can be used to update the IP address of the DVR. The DVR sends its latest IP address to this server and the user can then connect to this server to access its DVR.

To register the Static IP to DDNS, please refer to the following configuration.

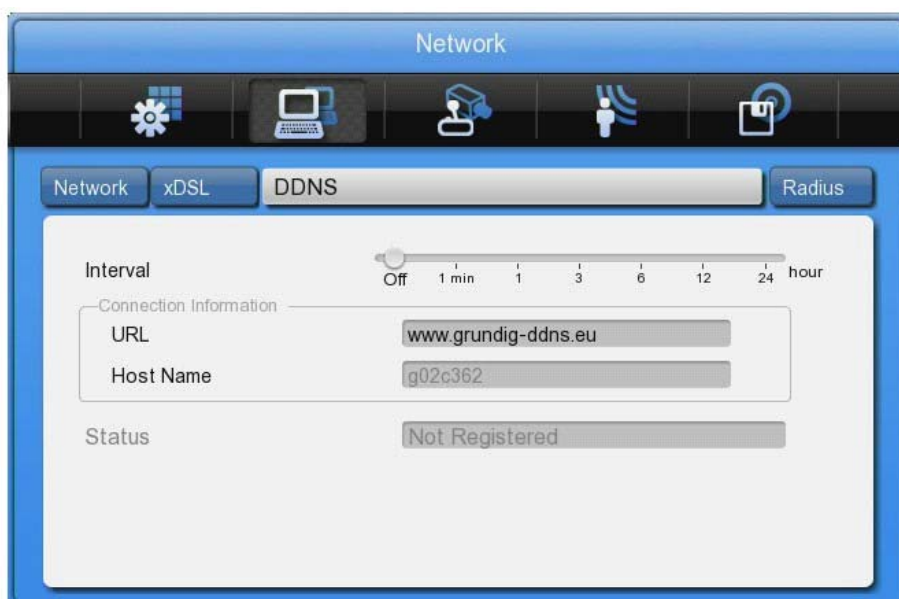

DDNS Interval:

For a continuous registration, the register interval should be activated. According to the chosen time interval, the DVR will renew its dynamic IP information in the DDNS server regularly. If the user turns the interval off or the DVR does not transmit any data for 2 days, the data will be removed from the DDNS.

DDNS URL:

This menu is for setting a server address where the DVR can register its dynamic IP address. The DDNS address, on which GRUNDIG is operating now, is: [www.grundig-ddns.eu](http://www.grundig-ddns.eu).

### 8.3. Device Setup

In this menu you can configure all devices that can be connected to the DVR, like cameras, monitors and keyboards.



Caution: NTSC and PAL cameras cannot be used at the same time. If changing the camera type from NTSC to PAL, the system should be rebooted.

#### 8.3.1. Camera Setup

Select the camera you want to configure, by selecting its channel.

Name:

Fill in the name the camera should have. This name will be shown on the monitor and will be also shown in the GRUNDIG Control Center.

When pressing the [Enter] button or clicking the mouse, you can enter the camera name in the text menu.



- Use the direction keys for selecting the characters. Choose a character with the [Enter] button.
- When using the mouse, just click on the characters.
- After selecting the text, press [Enter].
- To delete the text, press the [->] button.
- To make a space between letters, press [->].

## PTZ Setup:

In this menu it is possible to carry out an additional configuration for the PTZ Address and the PTZ Port.



### PTZ Home:

Enable or disable the Home function. If the PTZ is not used manually for a certain time, the camera will move back to the preset position.

### PTZ Idle Time:

Set the time period after which the PTZ moves to its PTZ Home position.

### PTZ Port:

Select the Port for PTZ control.

### PTZ Address:

Configure the address of PTZ.

### Using Channels:

Configure whether a channel is connected to a camera or not. After pressing [Enter], select a channel by using the Left / Right direction keys or the mouse wheel. Disabling a not used channel will improve recording and network transmission. Also the LED on the front of the DVR will not blink and there will be no "Video Loss" for this channel on the monitor and for event detection.

### AGC (Auto Gain Control):

The AGC function can be used to control the video signal input of the connected camera. Configure, enable or disable the brightness and contrast of the video with the direction keys or the mouse wheel.

### 8.3.2. Monitor Setup

Configure all connected monitors. Depending on the model of the DVR and the attached monitor different options are available.



#### Coverting channels:

In the Covert menu, the user can covert the channel in Live/Playback mode.

In the Covert menu, a channel list will be shown; checked channels will not be shown in Live mode and in Playback mode.

#### User sequence configuration:

Here you can configure the user sequence. You can edit up to 16 steps within an interval from 1 to 60 seconds. You can select a single channel and Multi-Mode views.

#### Multi mode:

GDVB8832A, GDV-C4416A and GDV-A4416A have the following predefined screen modes: 4E (4 channels), 9B (basic 7 channels and additional 2 channels) and 10A (10 channels). For GDV-B2208A only the 4E (4 channels) multi-mode is available.

#### The way to composing:

To compose your customised Multi Mode select first the target window and then the channel you want to add.

#### DVI Resolution:

There are different resolutions available: 800 x 600@56Hz, 1024 x 768@60Hz, 1280 x 720@50Hz, 1280 x 720@60Hz, 1920 x 1080p60, 1920 x 1080i50, 1920 x 1080i60, 1920 x 1080RB.

#### Display information:

In the Display information you can configure which information will be shown in live view and in playback view. In live view, time, channel name, event, recording status, HDD, Remote control ID, text can be set and in playback view, time, command, channel name, event and text can be displayed.

### 8.3.3. Audio Setup

In this menu the user can configure Audio recording, Volume, Synchronisation and Mixing.



**Audio Channel:**  
Select the channel you want to configure.

**Audio Recording:**  
Enable or disable the audio recording. If disabled, audio will be transmitted in live view, but will not be recorded. If audio recording is enabled, the recorded audio will also be available in playback mode.

**Synchronising Video Channels:**  
Configure which video channel is matched to a selected audio channel. This function is applied only to the recording. Audio out in live view will be set in the Voice Mixing option below. In the default setting the audio channel no.1 is matched to the video channel no.1.

**Audio Gain:**  
Configure the volume of the audio in the + /- direction.

**Audio Output Mix:**



Select the audio output in live view. If set to "All", input audio can be monitored in all channels. If configured to a certain channel, the audio can only be heard when you monitor the selected channel.



### 8.3.4. Text Setup



#### Recording:

Enable or disable the recording of transmitted texts.

#### Sync Text with:

Select the channel which will be synchronised with the text input.

#### Device:

Select the type of the Text input device you are using. Choose between VSI-Pro Hydra, Starfinger 007 or manual configuration. If you choose the manual configuration you have to set the Header, Delimiter, Time out and Lines settings.

#### Seek Header:

Activate or deactivate searching for the header of the data. You can define up to 2 different headers here. For information about the header, please refer to the manual of your text input device.

#### Delimiter:

The delimiter value may differ depending on the device used. For more information on delimiters, refer to the user manual of the text input device.

#### Time out:

The lines defined below are the maximum number of text lines available for one piece of data. Even though the number of lines is preset the actual number may differ sometimes. For example, three lines are programmed for a client name input for an ATM, but if someone registers only his/her first name and last name, only two lines will be provided when the person uses the ATM. The DVR will not be able to detect this automatically, so the Timeout function will be used to stop data recognition after the last line is entered.

#### Lines:

This defines the maximum number of lines for one piece of data.

Caution: If the external text input device cannot be recognised, please contact the seller of the external device.



### 8.3.5. Serial Setup

The DVR has 3 serial ports. One is a RS-232 serial connection and the other 2 ports are serial RS-485 connections.



Serial Port:

Select which serial port you want to configure.

Device:

Select the connected device.

Interface:

Configure which interface the device is using.

COM1 is RS-232C; COM2 and COM3 are RS-485.

Baud rate/Parity/Stop Bit/Data Bit:

Input a suitable value depending on the external device.

### 8.4. Event Setup

In this menu users can configure the handling of an event.



### 8.4.1. Event Check

Enable or disable the event checking algorithms. You can set up a schedule for the event check if you want to enable the event check only for a certain time frame. In the case of schedule mode, you can set up schedules for different dates and times, as shown in the following screenshot.

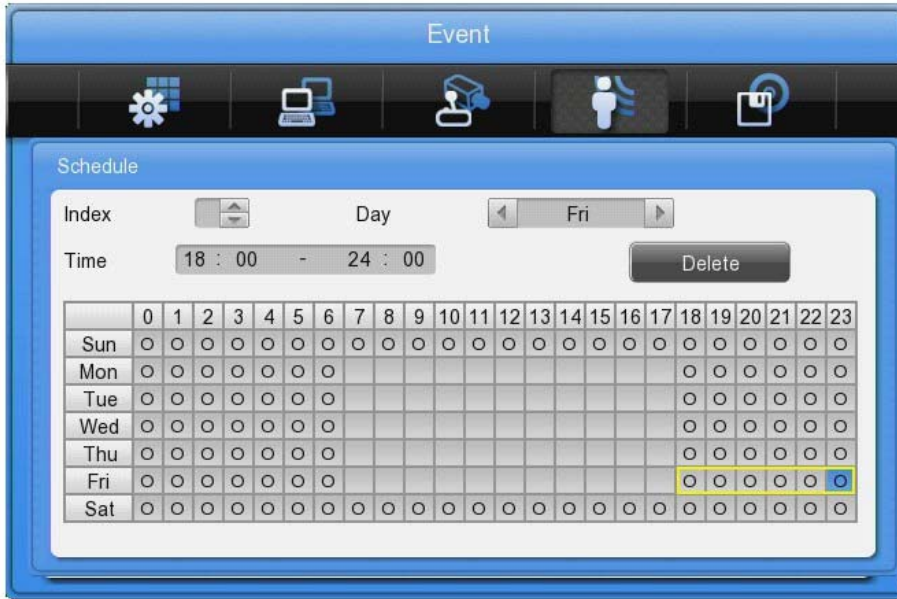

How to configure:

You can either input the schedule in the upper text fields by selecting the Index number, date and time, or you can select time zones directly in the calendar.

How to delete:

Select the INDEX you want to delete and click the "Delete" button.

When clicking the "Delete" button without selecting an INDEX, the last selected INDEX will be deleted.

How to change:

After selecting an INDEX you can change directly the weekday and time of the time zone.

### 8.4.2. Event Actions

Configure what action the DVR will perform if an event is detected.



Event Action:

There are 7 different actions you can choose from: Relay 1 to 4, Buzz, FTP and E-Mail.

**Action Duration:**

Select how long an Action Duration will be kept up. Relay and Buzzer can be configured from 5 seconds to 60 seconds. In the E-mail notification you can configure the repeating interval.

**Normal Event Source:**

The user can configure which event sources will be used for event actions. Depending on the model, the numbers of sources can differ. (S1-S16: Sensor; M1-M16: Motion Detection (channel); V1-V16: Video loss (channel); Text synchronisation)

Model	Sensor	MD	V-Loss	Text
<b>GDV-B8832A</b>	16	32	32	1
<b>GDV-C4416A</b>	16	16	16	1
<b>GDV-A4416A</b>	16	16	16	1
<b>GDV-B2208A</b>	8	8	8	1

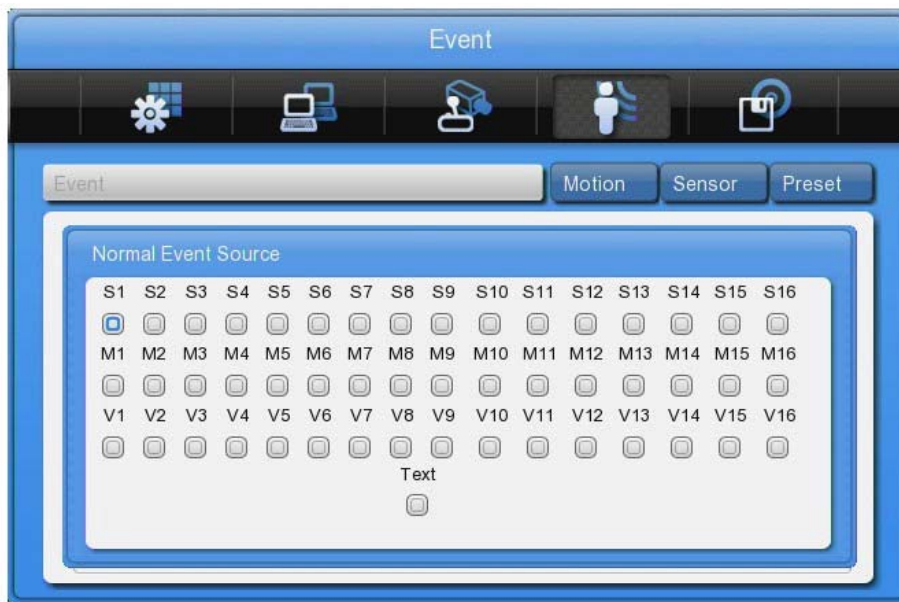

**System Event source:**

In the system event source menu you can configure which system events are used for event action (Bad block, Disk full, Fan error, Authorisation failure, DDNS registration failure).



**E-Mail:**

Here you can set up the sender & receiver E-mail address.

E-mail address:

Input the E-mail address to get an event alarm to this E-Mail address.

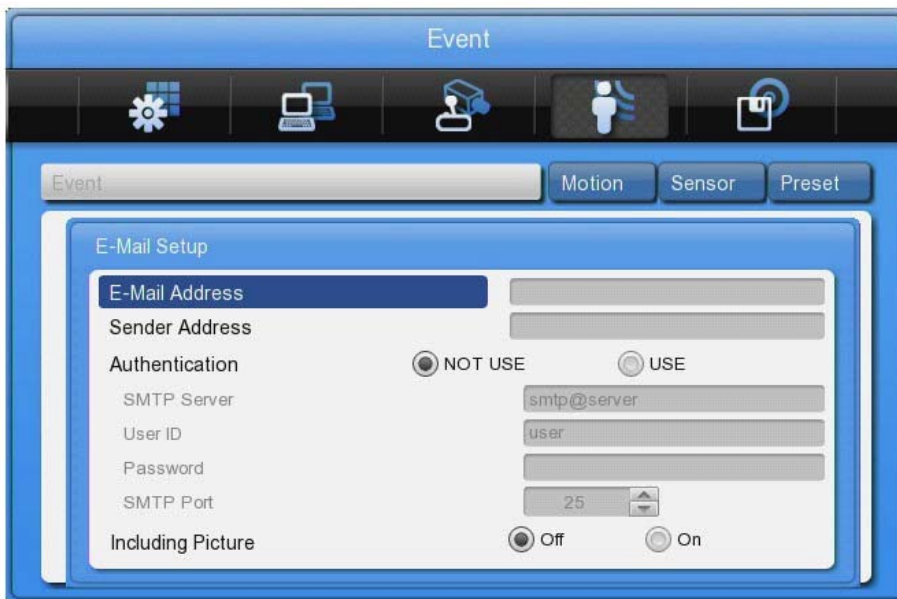

Sender Address:

Not mandatory, but necessary if the receiver wants to know which DVR sent the event.

Including Picture:

In a general event, when sensor, MD, video signal loss events are generated, the event information and channel information will be sent together with the E-mail. A system event just sends the system event information.

FTP setup:

Here you can set up all information needed to upload events to an FTP server.

Server URL:

Input the URL to connect to the FTP server. Please use either a DNS name or the static IP address.



User ID:

Please input the user name which will be used to access the FTP server.

Password:

Please input the password of the above user.

---

FTP directory:

If you want to include all the uploads in a dedicated directory please name it here. Make sure the directory exists on the FTP server.

### 8.4.3. Motion Detection



Channel:

Select if you want to configure all channels or only a dedicated one.

Sensitivity:

The sensitivity of the motion detection can be configured from min.1 to max.10, whereas 1 means less sensitive and 10 means very sensitive.

Area:

Select the detection area. The user can either select the whole area or can define a customised user area.

User Area:

A user area can only be defined for a single channel. The video is divided into 22x15 grids. After pushing the user area button, the configuration window for the detection area will appear.

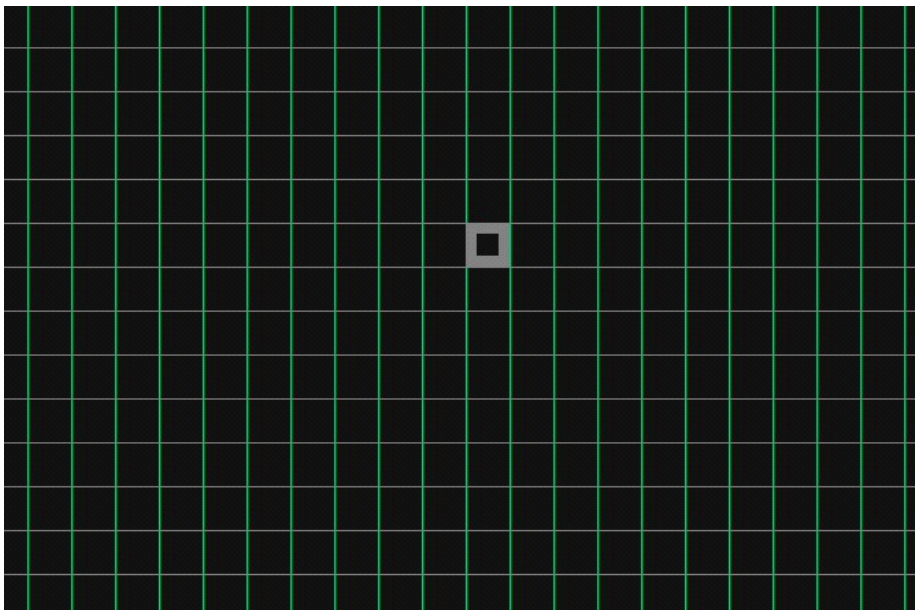

Select an area with the direction keys and press [Enter] or click the mouse to select or deselect an area which is used for motion detection. Press the [ESC] button or click the right mouse button to apply your settings and go back to the previous menu.

---

#### 8.4.4. Sensor

This menu is to set up the existing sensor input and the type of the sensor. GDV-B8832A, GDV-C4416A and GDV-A4416A have 16 inputs and GDV-B2208A has 8 inputs. The sensors can be either set to Normal Open (N.O.) or Normal Close (N.C.).



#### 8.4.5. Preset

Configure the presets for PTZ cameras when an event is detected. You can select between sensor events, motion detection and text synchronisation. You can configure up to 16 presets. The presets can be configured in the PTZ single channel view.

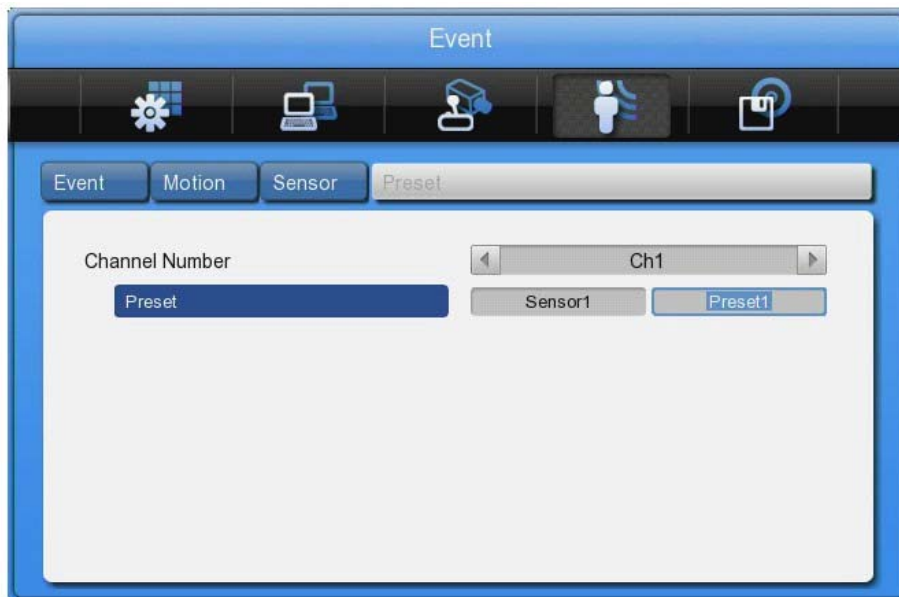

#### 8.5. Recording Setup

There are 3 modes for recording – schedule recording, manual recording, event recording. Schedule Recording records according to a configured schedule. Manual Recording records only after pushing the [REC] button and Event Recording records when events are detected.



## 8.5.1. Program Setup

Here you can setup the recording resolution, frame rate and quality for every channel for normal recording and for event recording.



**Program:**

There are 26 programs from A to I composing the recording quality and resolution per channel. For a detailed explanation please refer to the program configuration below.

**CH (Channel):**

Displays the channel number.

**R (Resolution):**

There are 3 resolutions: 4CIF (704x480), 2CIF (704x240) and CIF (352x240).

**F (FPS):**

FPS means frame per second. The user can select a frame rate from 1 to 25fps. The max. frame rate can differ according to the configuration.

**Q (Quality):**

There are 5 recording qualities: Q5 / Q4 / Q3 / Q2 / Q1. The recommended quality for event recording is Q3. Q1 has a low quality which needs less storage space and Q5 is a higher quality which needs more storage space.

**Max R/F:**

Max R/F shows the number of frames available according to the selected resolution. For instance, if it displays 25fps at CIF, it means that this channel can record up to 25 frames in CIF resolution.

**How to calculate the recording performance:**

$$4\text{CIF}[704 \times 480] = 2 \times 2\text{CIF}[704 \times 240] = 4 \times \text{CIF}[352 \times 240]$$

If 400 frames can be recorded in CIF resolution, instead of CIF you can record up to 200 frames in 2CIF resolution or 100 frames in 4CIF resolution.

**NOTE:** If you disable a channel or lower its resolution or its frame rate the unused bandwidth can be used for other channels to increase their frame rate or resolution.

**The relation between general recording and event recording:**

When an event is triggered, the DVR records with the event recording settings. The recording performance of the DVR differs for every model.

## 8.5.2. Manual / Continuous / Schedule Recording Setup

In the submenu "Record" you can select the recording behaviour. Select between Schedule & Event recording or Continuous & Event recording.

**Manual Recording:**

If set to Manual & Event, the DVR will record when pressing the [REC] button. It will stop recording when you press [REC] again.

You can also set which program is used for manual recordings.

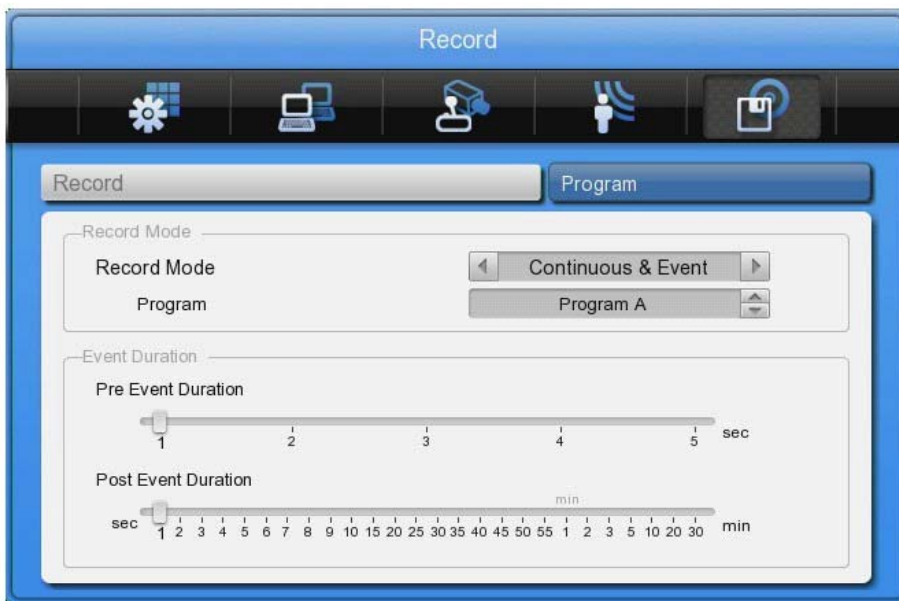

**Continuous Recording:**

If the DVR is set to Continuous & Event the DVR will record all the time. If an event occurs the recording setting will be changed from continuous to event settings.

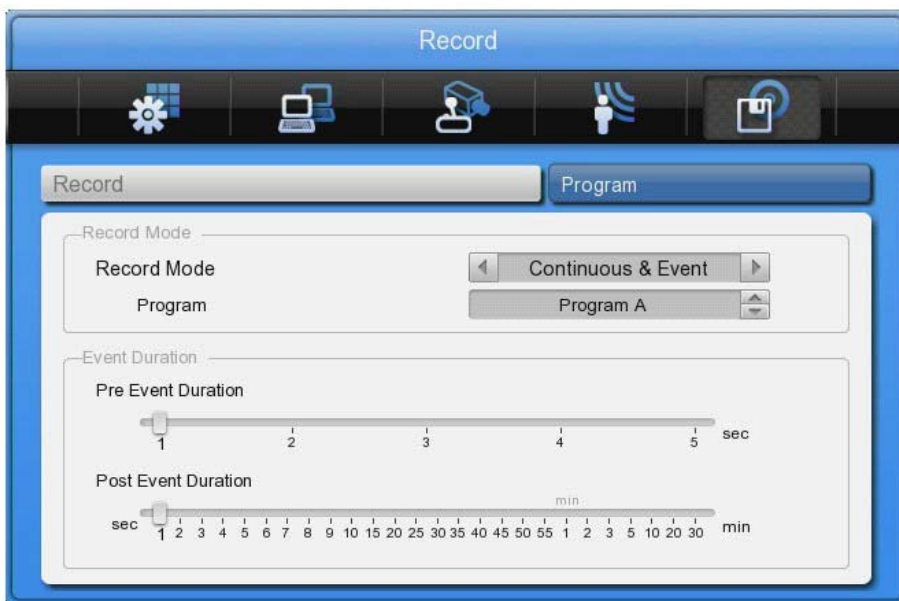



## Schedule Setup:

The DVR can record automatically, depending on the programmed schedule. Set the recording mode to Schedule & Event and configure the days and time in the schedule submenu.



Select the days and the time zones which you want to record. You can also select different programs for different times.

Note: If you want to define several time zones in one day, you need to increase the index manually for the DVR to detect that you want to define a new time zone index. Otherwise only the current index will be changed.



- INDEX: Schedule unit from 1 to 50
- Weekday: Set the applicable day
- Program: Set the recording program (A~Z)
- Time: Set the applicable time
- Cancel: Cancel per INDEX

## Configuration:

Configure the INDEX, weekday, program and time.

Select the recording start time and end time in the table by mouse, its index, weekday and program will be displayed in the calendar view. You can also do the configuration by selecting the day and the time frame in the calendar. The Index and all the other information will be shown in the upper fields.

---

**Deletion:**

Select INDEX and click the [Delete] button.

When clicking the delete button without INDEX, previously selected INDEX will be deleted first and after that, from the largest INDEX in order downwards to the smallest.

**Edition:**

Select an INDEX to edit and change the weekday, program and time directly. You can select it by putting in the Index number or selecting it in the calendar with the mouse.

Caution: If selecting the same time twice, “!” will be shown on the chart. When configuring the time sector, a previously configured time cannot be included in a new Index.

## 9. GRUNDIG Web Viewer

The GRUNDIG WebViewer is a Web application program to access the DVR over an Ethernet or Internet connection. You can monitor the live view or access the recorded data with this program.

The GRUNDIG WebViewer is divided into the Login page, the Monitor page, where you can monitor the live video, and the Playback page to access recorded videos.

### 9.1. System Requirements

	Minimum	Recommendation
CPU	Intel Pentium 4 / 3.0GHz	Core2duo E6750 or higher
Main Memory	1GB	2GB or higher
Video Memory	128MB	512MB or higher
Display	1280 x 1024 (with 32bit colour) or higher	
HDD	1GB or higher	
OS	Windows XP Professional (over SP2) / Window Vista Business (over SP1)	
Others	DirectX 9.0 or higher	

### 9.2. Login

After inputting the IP address of the DVR, the GRUNDIG WebViewer Login page will be displayed in the browser window.

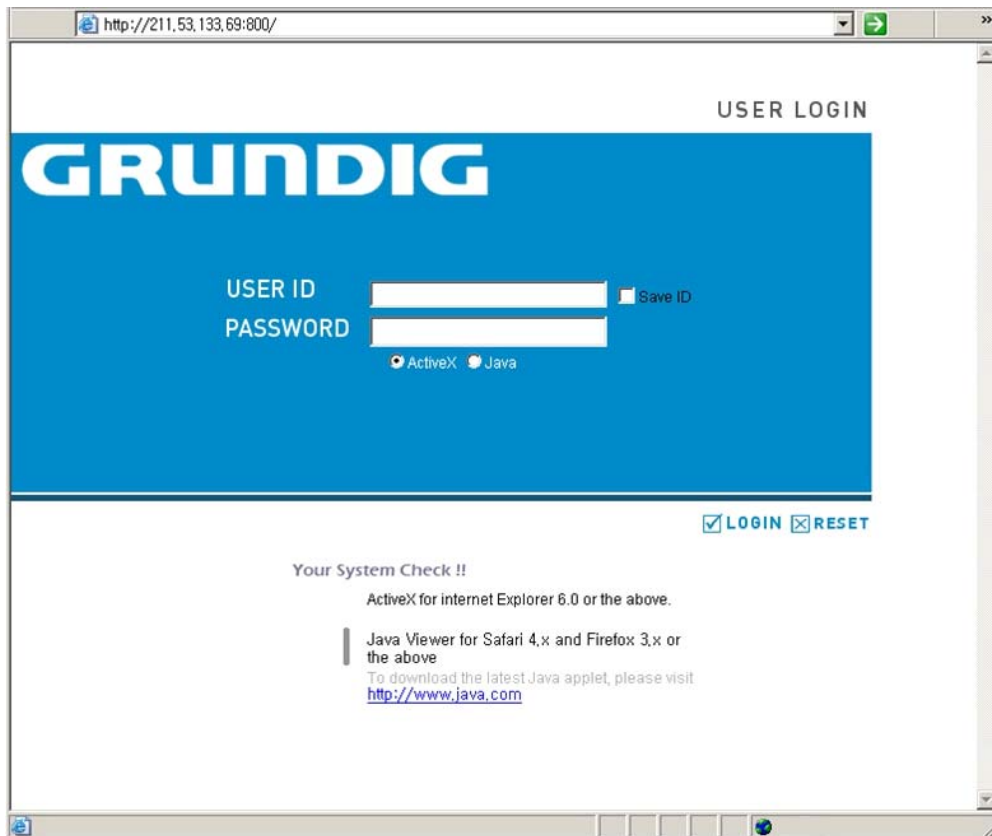

Input the User ID and Password and click 'LOGIN' to access.

If the user/administrator did not change the password in the Control Center, the ID and the Password will be:

ID: admin / user1 / user2 / ... / user10

Password: 1234 / 1111 / 2222 / ... / 0000

### 9.3. User Setup

To access the GRUNDIG WebViewer, user authority and password can be changed in the DVR or in the Control Center configuration (see the following images).

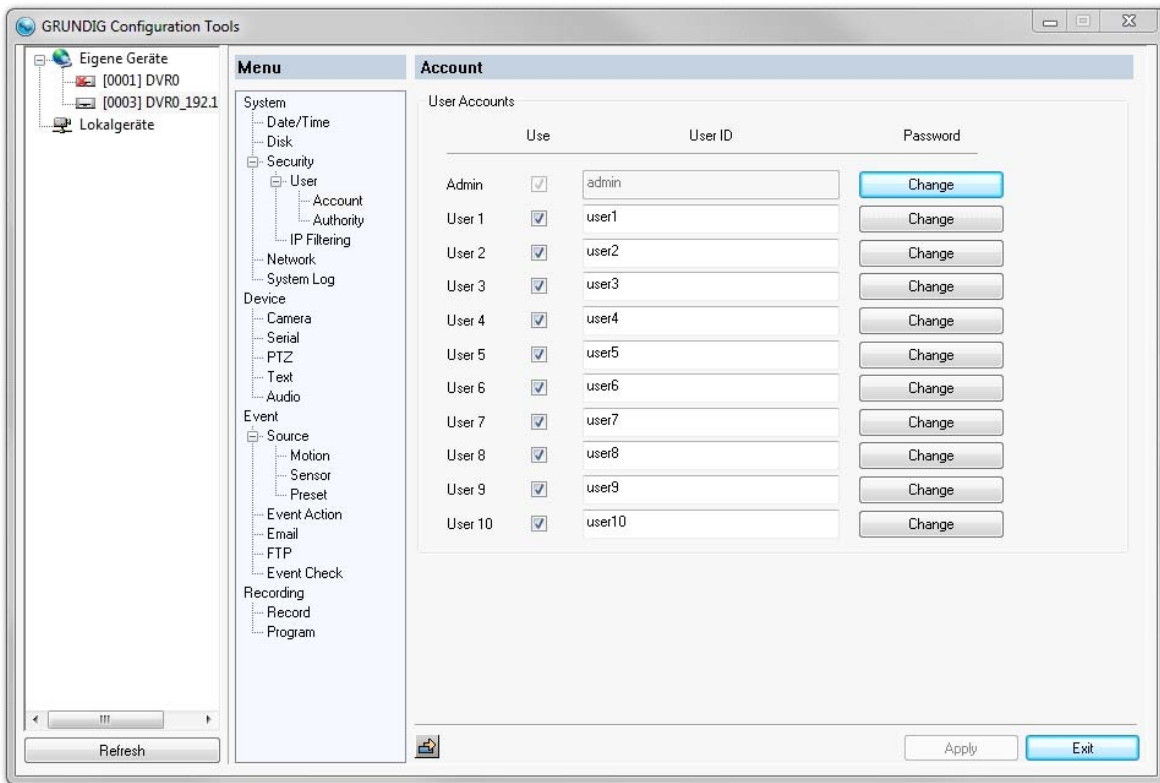

The basic admin password is "1234" and the user password is "1111" for User 1, "2222" for User 2 etc. The password for User 10 is "0000". A valid password can have up to 8 digits.

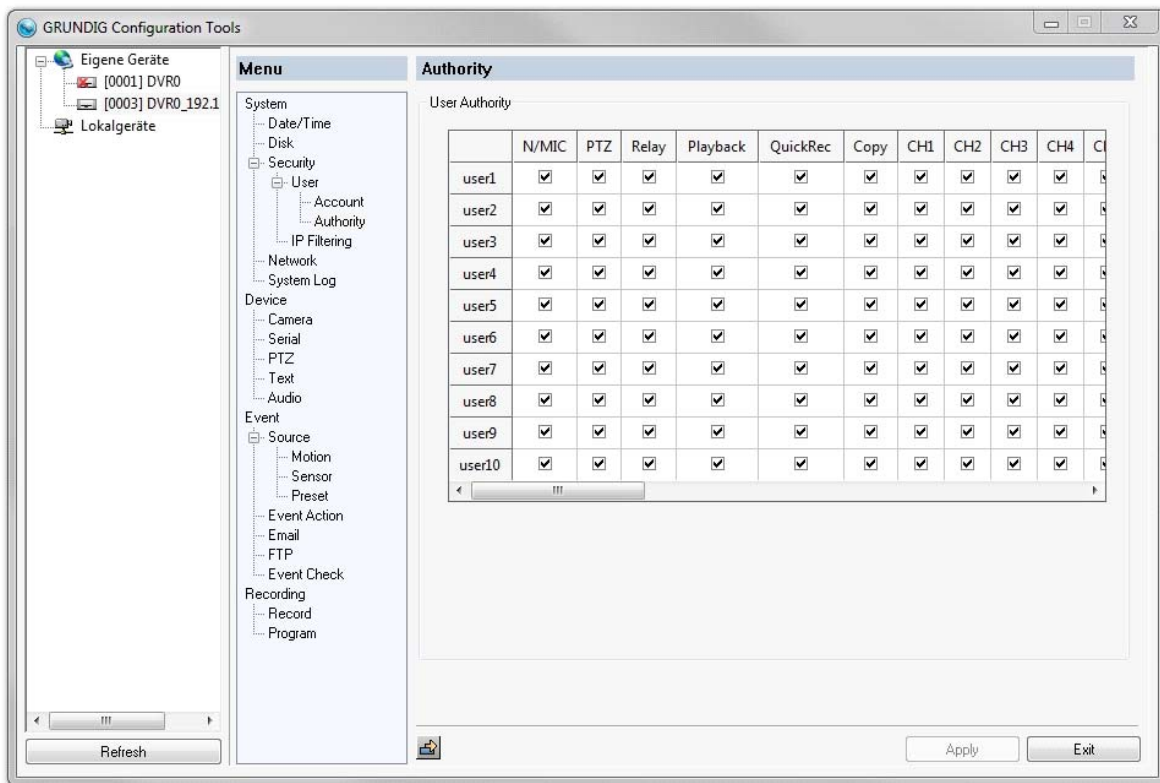

This authority configuration is almost the same in the DVR as in the Control Center. But the authorisation of quick recording and the covering of dedicated channels for a user are only possible in the Control Center.

## 9.4. Available Browser

The GRUNDIG WebViewer is optimised for the Windows Internet Explorer 6.0 or higher.

WebViewer Installer:

The Login page provides a manual installation program for the WebViewer.

A PC that accesses the WebViewer for the first time will install an ActiveX certificate to use the WebViewer's functions. If this installation fails, the installation program can be downloaded from the Login Page and installed manually.

Caution:

When installing the WebViewer Installer, all programs related to the Control Center have to be closed. Otherwise the installation might fail.

## 9.5. Monitor

When successfully authorised with User ID & Password input at the Login page, you will be directed to the Monitor page. On the Monitor page you can view live videos of cameras connected to DVR, or you can control a PTZ camera, Relays, and use the Microphone function according to user's authorisation.

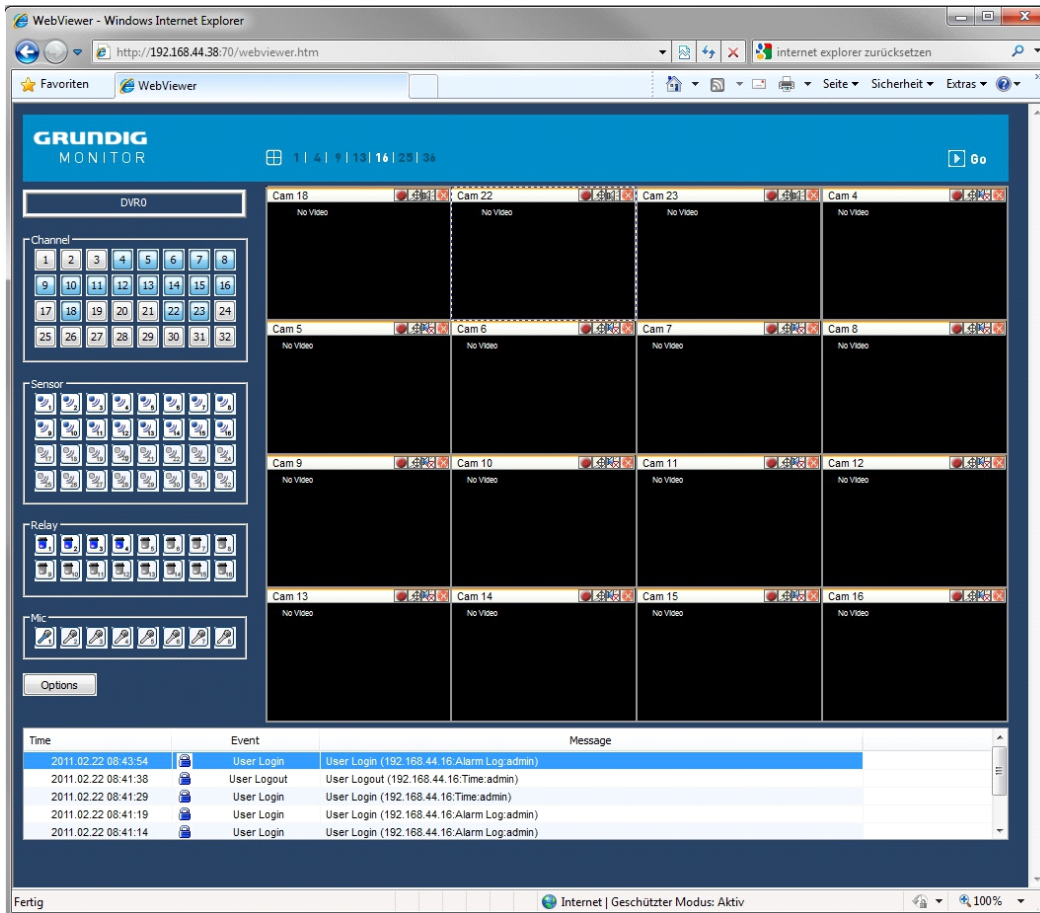

### 9.5.1. Screen division and changing video position

When accessing the Monitor page for the first time, 9 divisions, 16 divisions or 32 divisions (according to the number of channels of the DVR) are displayed.



You can change to 1, 4, 9, 13, 16, 25 or 36 divisions by clicking on the number on top of the page. Also, you can change to 1-channel mode by clicking on any of the channel images.

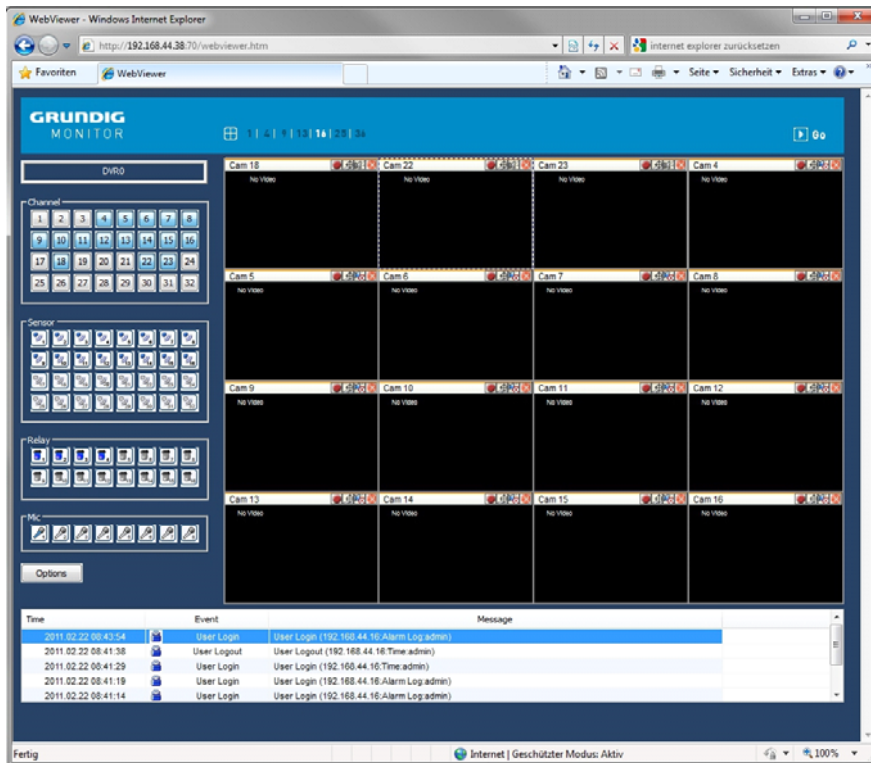

Double-click on one of the channels to switch to 1-channel mode.

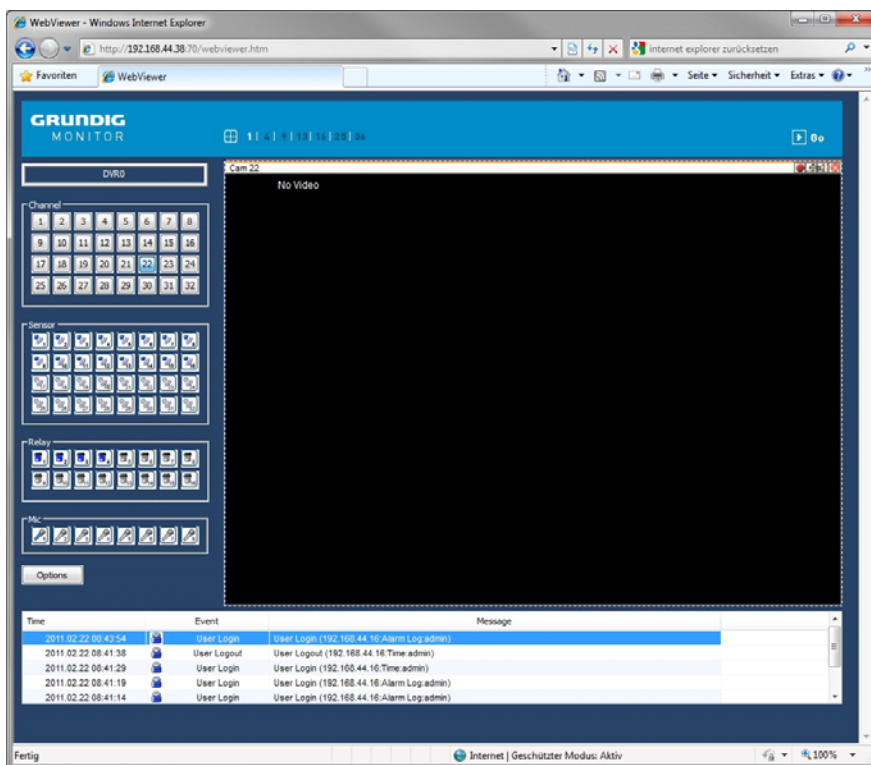

After entering 1-channel mode, a double-click on the screen will return to the previous division of channels.

On the division screen, you can change the screen location.

If you want to move channel 3 to the position of channel 6, drag the 3ch image and drop it on the 6ch location. Channel 6 will automatically move to the former position of channel 3.



---

### 9.5.2. Playback on Standard monitor (16 / 9 / 4 division)

Move to the playback function by clicking on the image above.



### 9.5.3. Channel On/Off

You can select which channels are played by clicking the On/Off button of the Channel located on the left hand side of the page.



### 9.5.4. Sensor Indication

The icons indicate whether a sensor event occurred in the system.



When a sensor is activated, the relevant sensor icon will change to red colour.

### 9.5.5. Relay operation

You can turn on or off the relays of the DVR within the WebViewer. Click the number button to activate the relay and the icon will change from blue to orange.

If you define a time for the relay in the Control Center, the Control Center will be turned off automatically after this configuration.



Activating relays is only possible when the user possesses the authorisation. Refer to the chapter "User Authority" in this manual for the setup of user authority for relays.





### 9.5.6. Using a microphone

You can enable or disable the use of a microphone within the GRUNDIG WebViewer. The default setting is Off. If a microphone is activated, the colour of the corresponding icon will change from blue to red.



### 9.5.7. Event Data





The event log is displayed at the bottom of the monitoring page and shows all the event information stored on the DVR.

2009.03.31 10:42:13		7 On	CH7 - Motion Detected
2009.03.31 10:42:13		6 On	CH6 - Motion Detected
2009.03.31 10:42:13		5 On	CH5 - Motion Detected
2009.03.31 10:42:13		1 On	CH1 - Motion Detected
2009.03.31 10:42:13		16 On	CH16 - Motion Detected

### 9.5.8. Relay operation

The indicated data is listed as follows:

[Table / Event Icon]

Button	Function
	Motion Detection On
	Sensor Input (Off, On)
	Relay Output (Off, On)
	No Video, Video Detected

### 9.5.9. Video Recording & Safe Saving

Video Recording:

During monitoring, the GRUNDIG WebViewer can record up to 10 minutes of video by clicking the Quick Recording button (the red dot in the top panel). During Quick Recording, the recording time is shown on the video.



During video recording, click the Quick Recording button to stop recording and a dialogue box will be opened to store the recorded files.

Saved recording files are saved in "\*.re4" file format. The .re4 file can be played back by the GRUNDIG Control Center Playback software or the GRUNDIG Mini Player software.

Screenshots:

You can make a screenshot of the video by clicking on the right mouse button in the selected channel and by choosing the "Save As" option. The picture can be stored in .jpg, .bmo or .eye file format.



---

### 9.5.10. Using PTZ

Among the icons on the top of a video in monitoring mode, click 'PTZ' to activate the control Pan, Tilt, Zoom, and Focus. If a PTZ camera is connected and already set to PTZ, this button is activated by default.



#### Pan/Tilt Control :

Users can implement pan/tilt control by first moving the cursor to the live video pane; then left-click and drag the pointer in any direction.

#### Zoom/Focus Control:

Move the mouse to the left and right edge to see the slide bar for Zoom and Focus.

#### Move to Preset:

In case you have a set preset for a PTZ in the DVR, you can access it by right-clicking the mouse and selecting "Go to Preset". When selecting a preset position from the preset list, the camera will move to the selected preset position.

#### Activating Auxiliary:

In case of a preset set, the "Auxiliary" function is indicated additionally, and can be operated after you selected the designated menu.

#### NOTE:

For a supported PTZ camera list please refer to 6.9. PTZ Control.

### 9.5.11. Using Audio

In case of Channel setup synchronisation with Audio, press the right mouse button on the channel to activate the pop-up menu "Listen" or activate the audio listen button. In the default setting the audio is muted. To activate the audio transmission, select it in the pop-up menu or click the corresponding button.



## 9.5.12. Closing Video Channel

You can disable and enable channels by clicking on the corresponding button at the top of the screen.



## 9.6. Playback

If you have the user rights to play back video, you can access the Playback screen when pressing the “Go” button on the Monitor screen of the GRUNDIG WebViewer.

In the Playback screen you can monitor up to 16 video streams simultaneously and search through a calendar to see recorded video from that date. You can make backups of the videos and save images in .bmp format or print them directly.

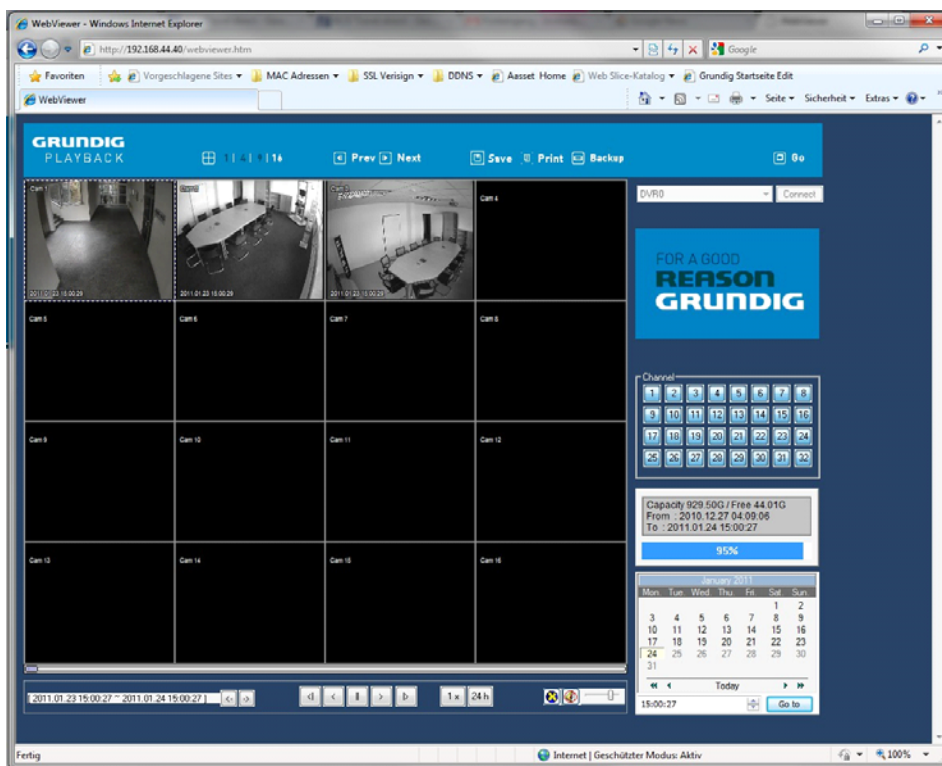

### 9.6.1. Video Division & Changing Channel



The Playback supports 1, 4, 9 and 16 divisional screens. You can select the number of divisions using the menu on the top of the page as shown in the picture above.

If the screen shows 4 divisions CH1~CH4, you can change to CH5~CH8 using the 'Next' button. Press the 'Prev' button to call for the previous channel group CH1~CH4.

The 32ch DVR can call the channels 17-32 using the group moving button as follows:



---

### 9.6.2. Image recording

You can save a playback image as '.bmp' picture file.  
Select the channel with the mouse and click the 'Save' button.



A Save Image dialogue box appears and you can input a memo text or select if the channel name, date and event data should be written unto the file.

Press 'OK' to open the dialogue box for the saving location, then you can save it as a '.bmp' file.

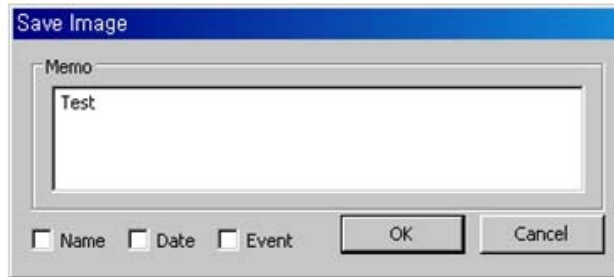

### 9.6.3. Printing

Select the channel you want to print, and click the 'Print' button.

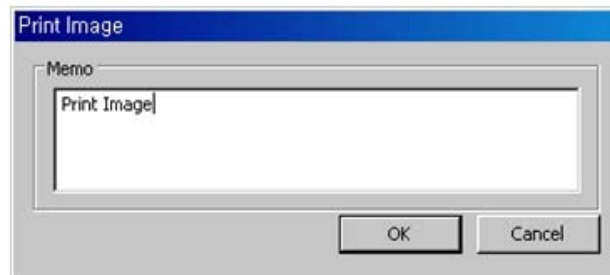

A window pops up to input a memo text. Click the 'OK' button to print the image on the connected printer. The Printout will include the 'Printing Date', 'Channel name', 'Recording Date', 'Event' and the 'Memo' text.

#### 9.6.4. Backup

You can choose between .rec (multi-channel) or .avi (single-channel) backup. Select the time, date and channel you want to back up and choose a location to save the file to.

If you want to secure the video file you can input a password which has to be verified.

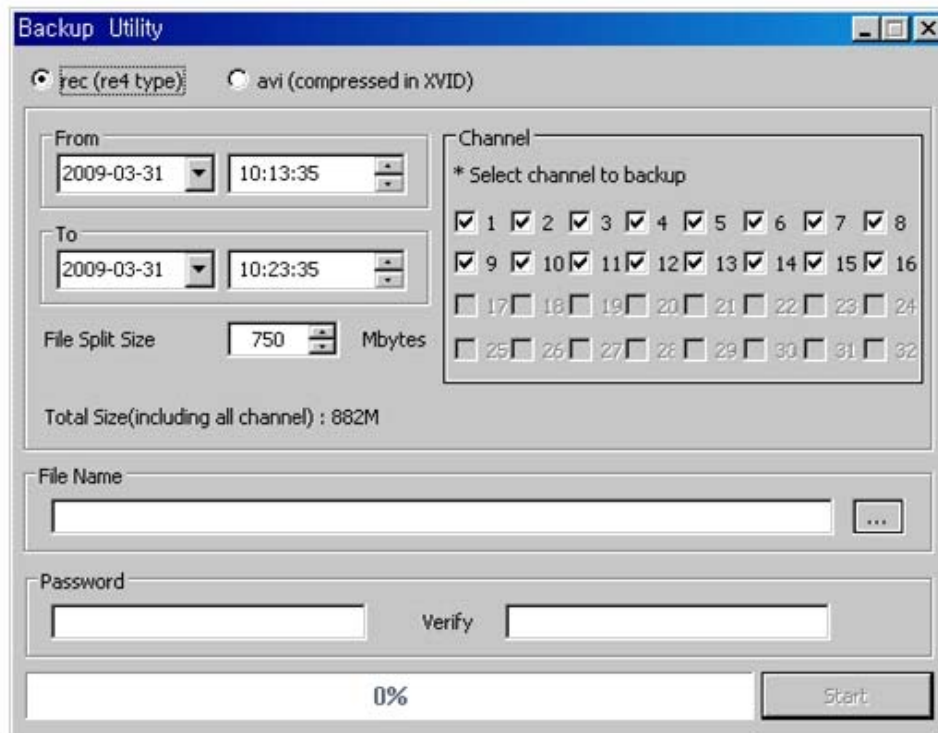

#### 9.6.5. Web Monitor

Click on the 'Go' button at the top of the page to return to the Web Monitor page.



#### 9.6.6. Channel On/Off

This function is similar to the Channel On/Off function of the Web Monitor.

#### 9.6.7. Saving Time & Checking Rec. Capacity

This field indicates the total capacity of the HDD and also displays the Starting date & Last date of the recorded video on the DVR. The image shows the percentage (%) of the DVR's HDD capacity.

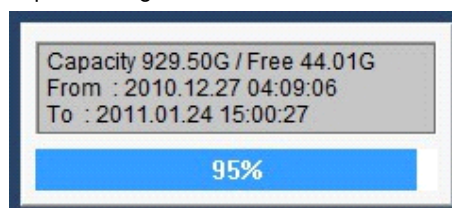

### 9.6.8. Searching in the Calendar

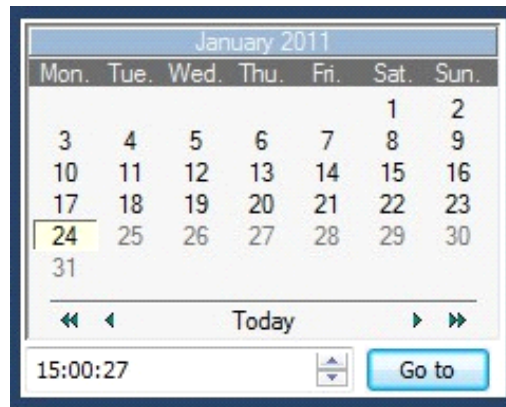

When a video was recorded on a special date, that day will be coloured in black. When a day is coloured in grey, this means that there was no video recorded on this date. Select the year, month, day and time to play back the video of that date.



When clicking on the 'Go to' button, you get access to the 24 hours of that date.

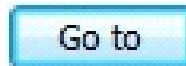

### 9.6.9. Functions at the bottom of monitor



(1) Indicates the playback range of the recorded image.

(2) Press the -> <- buttons to jump to the time area of an earlier or later time.

(3) From left to right: 'One frame back', 'Play backward', 'Stop', 'Play', 'One frame forward'.

(4) Here you can set the playback speed. After clicking the button, it can set the playback speed to '0.5x, 1x, 2x, 4x, 16x, 32x, 64x, and All'.

(5) Here you can set the time area. After clicking the button, select the time area out of '10min, 30min, 1hour, 3hour, 6hour, 12hour, 24hour'.

(6) Here you can select if you want to use DirectX or not. If checking/activating DirectX mode, the WebViewer will use the graphic card of the PC to display the video. This will reduce the CPU workload.

(7) Here you can set if audio should be played or not, and you can change the volume.

---

## 10. GRUNDIG Live Mobile Viewer

The GRUNDIG Mobile viewer is a viewer service for monitoring video with many different mobile devices. To access the mobile viewer, the user needs a mobile device supporting Wi-Fi or 3G.

### 10.1. Log-In page

The picture below shows the Mobile viewer log-in page.

To access the log-in page via mobile viewer, please type in the address in the following format:  
`http://IP/mvmenu.html`.

E.g.: `http://192.168.44.40/mvmenu.html`

or: `http://g0187D3A.grundig-ddns/mvmenu.html`

To log-in, please enter the ID and the password, select the resolution, the channel number and the refresh rate. Press the [Start View] button or [0] on a mobile phone without a touch screen to start the monitoring.

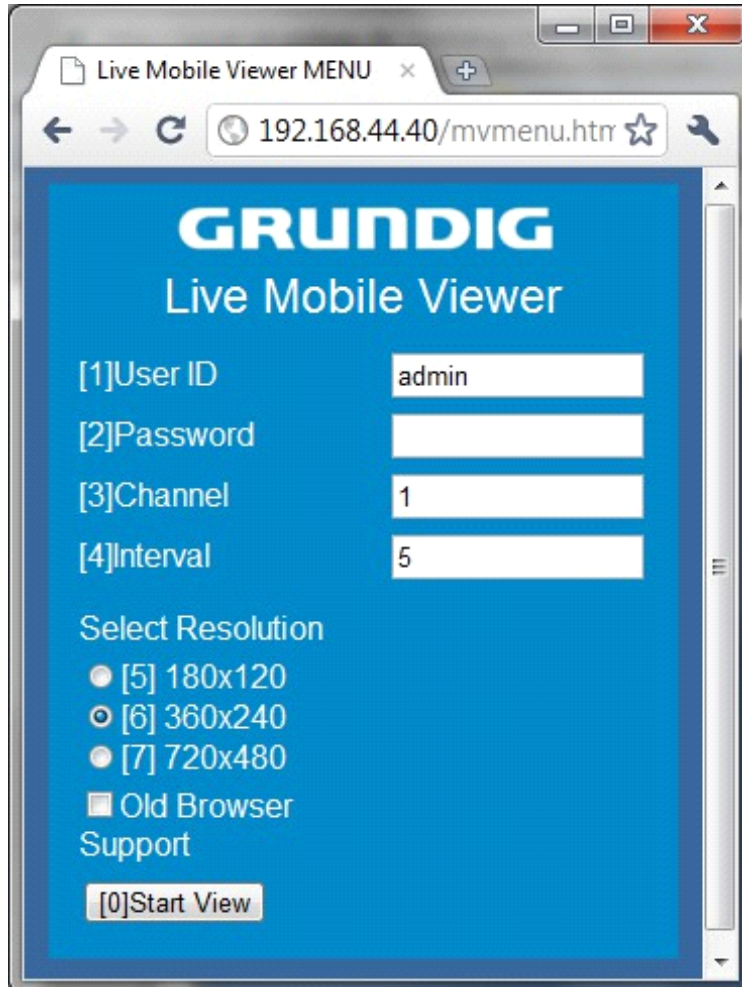



## 10.2. Monitoring page

The monitoring page shows the selected channel video and some functions you can use, right below the video display. The functions can be activated by pressing the buttons (touchscreen devices) or pressing the corresponding number on your phone keypad.

For the functions, please refer to the description below.

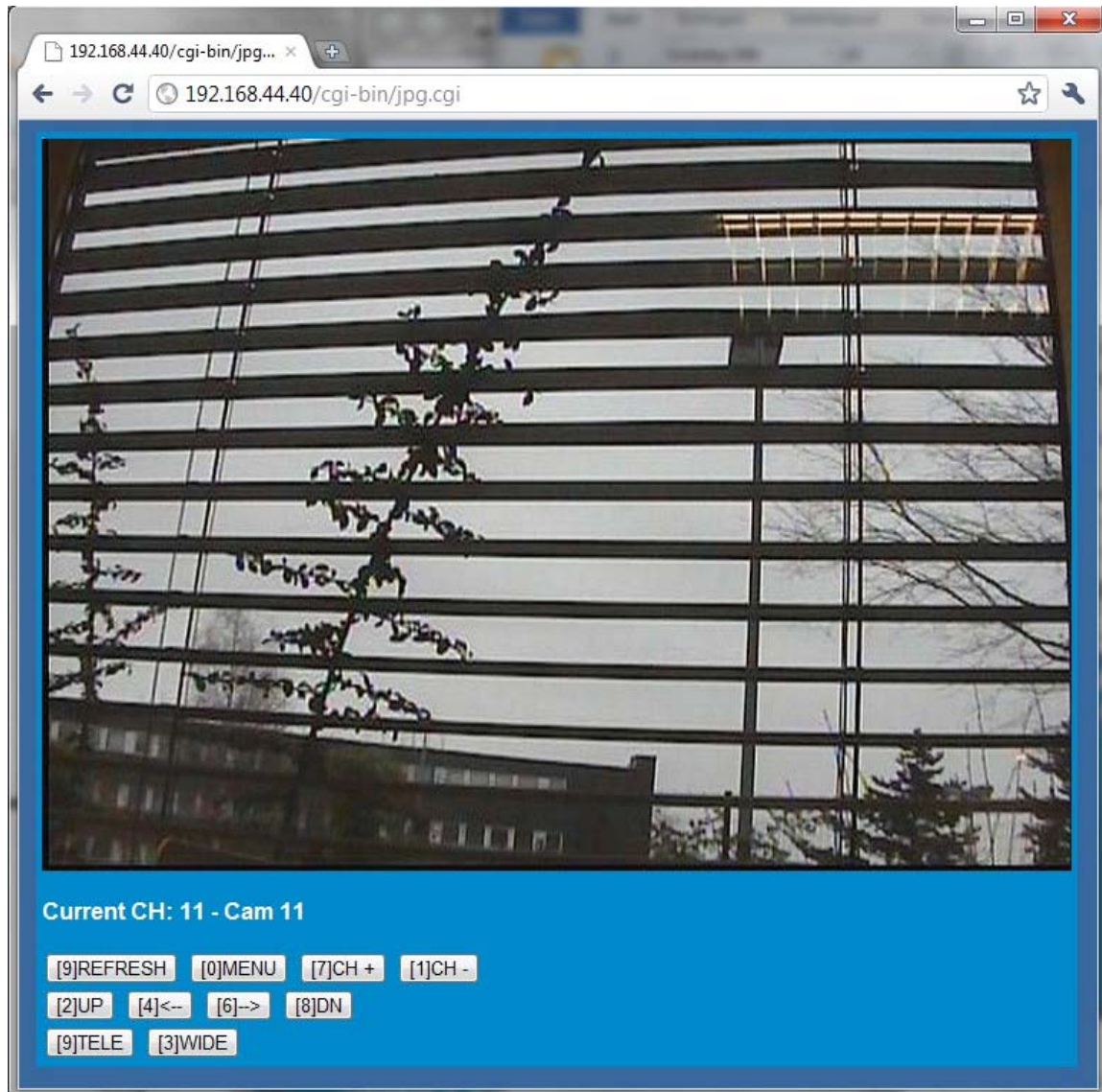

- (0) MENU : Move back to Login page
- (1) CH- : Move to previous channel
- (2) UP : If the channel is PTZ you can move the camera up
- (3) WIDE : If the channel is PTZ you can zoom out
- (4) <- : If the channel is PTZ you can move the camera to the left
- (6) -> : If the channel is PTZ you can move the camera to the right
- (7) CH+ : Move to next channel
- (8) DN : If the channel is PTZ you can move the camera down
- (9) TELE : If the channel is PTZ you can zoom in

---

**Specifications GDV-B2208A**

Operating System	Embedded OS
Video Inputs	8 CH Composite, BNC, Looped
Video Outputs	2 CVBS (1 Main, 1 Spot), 1 DVI (HDMI/VGA compatible)
Basic Internal Storage	1 TB
Storage Max. Expansion	8 TB, 2 internal and 1 external eSATA HDD
Video Compression	H.264, JPEG
Recording Resolution	Full D1 (704x576), Half D1 (704x288), CIF (352x288)
Recording Speed	200fps (352x288), 200fps (704x288), 100fps (704x576)
Recording Mode	Continuous, Event Alarm, Motion, Video Loss, Schedule, Manual
Display Resolution	max. 1920 x 1080
Display Speed	200 fps
Internal Backup	Built in DVD-RW drive
External Backup	USB HDD, USB Memory, DVD-R, Network, eSATA
Search Mode	Date/Time, Event Alarm, Motion, Video Loss
Motion Detection	On/ Off/ Area Setting
Event Source	Motion, Alarm, Text, Video Loss, System
Event Action	Pop-Up, Relay, E-Mail, FTP, Network, Buzzer, PTZ Preset
Audio Inputs	4 CH, RCA
Audio Outputs	1 CH, RCA
Alarm Inputs	8 contact input N/O or N/C
Alarm Outputs	2 Relay
Interfaces	2 port RS485, 1 port RS232, System Keyboard, 1 Ethernet and 2 USB 2.0 ports
ATM/POS	Support up to 16 ATM/POS with VSI-Pro Hydra Modules
Video Streaming	Versatile Triple Streaming (Dual H.264 + single JPEG)
Network	Ethernet, 10/100 Base-T, ADSL Static IP, ADSL Dynamic IP(PPPoE), Cable Network (Dynamic IP)
Client software	Windows (XP, Vista, 7), Web Viewer: IE, Firefox, Safari, Chrome; Mobile: iPhone (OS4), Blackberry, Android, Windows Mobile, Symbian
Time Setting	Setting by NTP Server local or internet
Multiplex Function	Pentaplex
Auto Switching	0, 3, 5, 10, 20, 30 sec, Event or manual
Supply Voltage	110 ~ 240 VAC/50Hz
Power Consumption	75 W
Weight	8.2 kg
Dimensions (wxhxd)	445 x 88 x 418 mm

**Specifications GDV-A4416A**

Video Inputs	16 CH Composite, BNC, Looped
Recording Speed	400fps (352x288), 200fps (704x288), 100fps (704x576)
Display Speed	400 fps
Alarm Inputs	16 CH
Alarm Outputs	2 Relay
Power Consumption	75 W
Weight	8.2 kg
Dimensions (wxhxd)	445 x 88 x 418 mm

**Specifications GDV-C4416A**

Video Outputs	4 CVBS (4 Main) incl. 2 DVI (HDMI/VGA compatible)
Recording Speed	400fps (352x288), 400fps (704x288), 400fps (704x576)
Alarm Inputs	16 contact input N/O or N/C
Alarm Outputs	4 CH
Power Consumption	75 W
Weight	8.9 kg
Dimensions (wxhxd)	445 x 88 x 418 mm

**Specifications GDV-B8832A**



Video Inputs	32 CH Composite, BNC, Looped
Recording Speed	800fps (352x288), 800fps (704x288), 400fps (704x576)
Display Speed	800 fps
Power Consumption	85 W
Weight	8.9 kg
Dimensions (wxhxd)	445 x 88 x 418 mm

## Dimensions

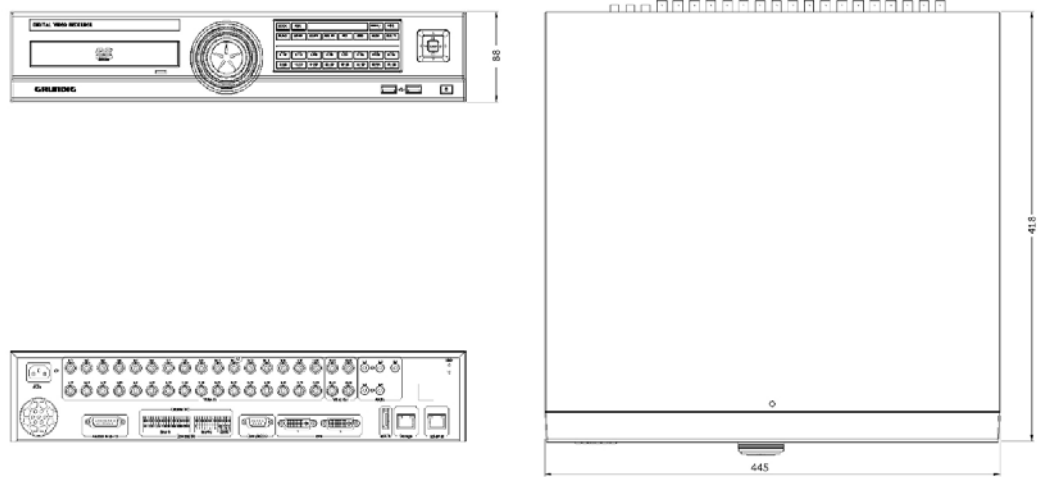

## EC Declaration of Conformity



GDV-B2208A	8-Kanal Digitalrekorder mit DVD-RW H.264
GDV-A4416A	16-Kanal Digitalrekorder mit DVD-RW H.264
GDV-C4416A	16-Kanal Digitalrekorder mit DVD-RW H.264
GDV-B8832A	32-Kanal Digitalrekorder mit DVD-RW H.264

It is hereby certified that the products meet the standards in the following relevant provisions:

EC EMC Directive 2004/108/EC  
Low Voltage Directive 2006/95/EC

Applied harmonised standards and technical specifications:

EN 60950-1 Part 1  
EN 55022 Class A (2006 + A1: 2007)  
EN 61000-3-2 (2006)  
EN 61000-3-3 (2008)  
EN 61000-3-3 (1995 + A1: 2001 + A2: 2005)  
EN 50130-4

### ASP AG

Lüttringhauser Str. 9  
42897 Remscheid  
Germany

Remscheid, 04.03.2011

Ludwig Bergschneider  
CEO