



EN

User Manual

**1/2.9" HD Camera, 2560x1440,
Day&Night, AF Zoom, WDR,
3.2-9 mm, Indoor**

MPC-54A0003M0A

Table of content

- Parts supplied 5**
- Part names 6**
- Operating instructions 7**
 - Power Supply connections..... 7
 - Using OSD Control controller 7
 - OSD menu table 8
- OSD Menu Setup 10**
 - 1. ZOOM / FOCUS 10
 - 2. EXPOSURE 13
 - 3. SCENE ENHANCE 14
 - 4. 3D-NR 16
 - 5. DAY / NIGHT 16
 - 6. PICT. ADJUST 18
 - 7. SPECIAL 19
 - 8. SYSTEM 21
 - 9. EXIT 23
- Further information 23**

Safety instructions

EN

General safety instructions

- Before switching on and operating the system, first read this safety advice and the operating instructions.
- Keep the operating instructions in a safe place for later use.
- Installation, commissioning and maintenance of the system may only be carried out by authorised individuals and in accordance with the installation instructions - ensuring that all applicable standards and guidelines are followed.
- Protect the devices from water penetration and humidity, since these can cause lasting damage.
- Should moisture nevertheless enter the system, under no circumstance switch on the devices under these conditions, instead send them for examination to an authorised specialist workshop.
- The system must never be used outside of the technical specifications, since this can destroy it.
- The device must be protected from excesses of heat, dust, humidity and vibration.
- When separating the system from the voltage supply, only ever use the plug to pull out the cable. Never pull directly on the cable itself.
- Lay the connecting cables carefully and check that they are not mechanically stressed, kinked or damaged and that no humidity can penetrate into them.
- In the event of a malfunction, please inform your supplier.
- Maintenance and repairs may only be carried out by authorised specialist personnel.
- The system must be isolated from the power supply before opening the housing.
- The device may only be opened by qualified service personnel. Unauthorised access invalidates any warranty claim.
- Connection cables should always be exchanged through Videor E. Hartig GmbH.
- Use only original spare parts and accessories from Videor E. Hartig GmbH.
- The housing should only be cleaned using a mild domestic cleaning agent. Never use solvents or petrol as these can permanently damage the surface.
- During installation, it is essential to ensure that the seals provided are correctly installed and that they are not displaced during installation. Damaged seals must not be installed and will invalidate any warranty.
- The installer is responsible for the maintenance of the enclosure as per the technical data, e.g. by sealing the cable outlets with silicone.
- Wire end ferrules should be used when shortening the flexible connection cables.
- The devices may only be operated in the temperature range indicated in the data sheet and within the defined air humidity range.

Product - Specific Safety Instructions

- The camera may never be pointed directly at the Sun with the aperture open (this will destroy the sensor).
- It is unavoidable that during manufacture and to a certain extent during later use, humidity will be present in the ambient air within the device's housing. In the event of large temperature fluctuations, this humidity may condense inside the housing.
- To avoid this condensation inside the very tightly sealed housing, the manufacturer has inserted silica gel sachets in the housing of the various camera types.
- It is however a physical given, that these silica gel bags will reach saturation after a certain amount of time. They should therefore be replaced with new silica gel sachets.
- During installation, it is essential to ensure that the seals provided are correctly installed and that they are not displaced during installation. Damaged seals must not be installed and will invalidate any warranty.
- A multipolar, easily accessible isolation device should be installed in the proximity of the IR Spotlight, in order to disconnect the device from the power supply for service work.
- The earth connection must be made according to the low impedance requirement of DIN VDE 0100.
- Subsequent painting of the equipment surface can impair the function.
- Any warranty claim is invalidated by subsequent painting.
- A safety margin of > 1 m from the spotlight must be maintained when viewing directly into the IR Spotlight in a darkened environment.
- Do not look directly at invisible LED radiation using optical instruments (e.g. a reading glass, magnifying glass or microscope), since this can endanger the eyes, LED Class 1M.
- Operation of the IR spotlight with a defective cover or during repair is prohibited.

Class A device note

This is a Class A device. This device can cause malfunctions in the living area; in such an event, the operator may need to take appropriate measures to compensate for these.

WEEE (Waste Electrical & Electronic Equipment)

Correct Disposal of This Product (Applicable in the European Union and other European countries with separate collection systems).



This marking shown on the product or its literature, indicates that it should not be disposed with other household wastes at the end of its working life. To prevent possible harm to the environment or human health from uncontrolled waste disposal, please separate this from other types of wastes and recycle it responsibly to promote the sustainable reuse of material resources. Household users should contact either the retailer where they purchased this product, or their local government office, for details of where and how they can take this item for environmentally safe recycling. Business users should contact their supplier and check the terms and conditions of the purchase contract. This product should not be mixed with other commercial wastes for disposal.

Graphical symbols

Please pay attention to the safety instructions, and carefully read through this instruction guide before initial operation.



Important points of warning are marked with a caution symbol.



Important points of advice are marked with a notice symbol.

Parts supplied

- Box camera
- Operating instructions

EN

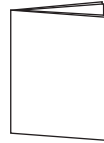
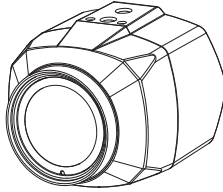

Part names

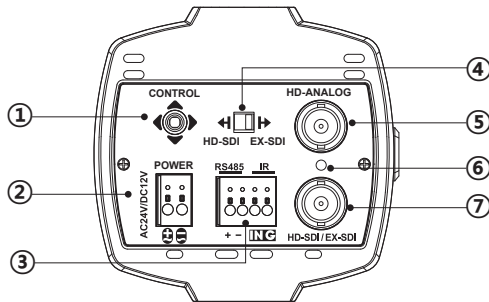
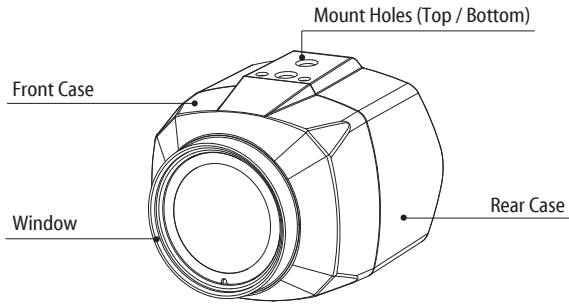

- ① OSD Control Joy stick
- ② Power input terminal (AC24V/DC12V)
- ③ RS-485 / IR connector
- ④ Video format selection Switch
- ⑤ HD-Analog output connector
- ⑥ Power LED
- ⑦ HD-SDI/EX-SDI output connector



CAUTION:

Extreme care should be taken NOT to scratch the window in front of lens.

Care should be taken the cable is NOT to be damaged, kinked or exposed in the hazardous area.

Do not expose the camera directly to a strong light source such as the sun or spot light.

Operating instructions

Power Supply connections

Camera can work with either 24VAC or 12VDC, dual voltage power. Primary and secondary grounds are completely isolated to avoid the possible ground-loop problems.

EN

Using OSD controller

Setup menu can be accessed and controlled by OSD control joystick on the rear of the camera unit. Five commands are available with the joystick.

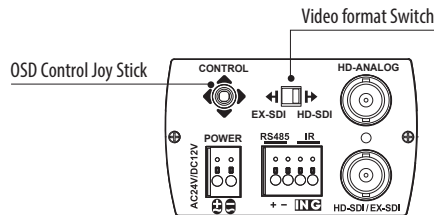

- i** HD-SDI or EX-SDI is selectable by Video format switch only. TVI mode or AHD mode is selectable in the menu only. (SYSTEM> ANALOG MODE)

◀▶ Description of the OSD control operation

1. SET (●) : Access to the menu or enter the setting. To enter the main menu, press the Set Key down.
2. UP/DOWN (▲/▼) : Choose the desired sub-menu and to move the cursor up or down.
3. LEFT/RIGHT (◀/▶) : Set up the value of the selected menu. Used to adjust the desired menu selection and to move the cursor left or right.
4. '👉' denotes the long press down straightly for about 2 seconds

◀▶ Description of the Motorized ZOOM&FOCUS adjustment

- i** Works only when OSD Menu is inactive.
- | | |
|-----------------|-------------------|
| 1. ▲ : Zoom In | 3. ◀ : Focus Near |
| 2. ▼ : Zoom Out | 4. ▶ : Focus Far |

Operating instructions

OSD menu table

MENU	SUB Menu	Configuration		
ZOOM/FOCUS	ZOOM	ZOOM SPEED	SLOW, MID, FAST	
		POI ZOOM	H/V-POINTER	
		PRESET ZOOM	ZONE NUM, ZONE VIEW, H/V POS, ZOOM RATIO	
		SMART MOTION ZOOM	ZONE NUM, WINDOW USE, MOTION WIN SET, H/V POINTER, ZOOM RATIO, DURATION, SENSITIVITY	
		HOME POSITION	O-ZOOM RATIO, DURATION	
		RATIO DISP	OFF, ON	
	FOCUS	FOCUS MODE	ZOOM PUSH, AUTO, MANUAL	
		LENS INIT.	ON 	
EXPOSURE	MODE	AUTO, IRIS PRIOR, SHUT PRIOR, MANUAL, FLICKERLESS		
	BRIGHTNESS DAY	0~20		
	BRIGHTNESS NIGHT	0~20		
	SENS-UP	OFF, x2, x4, x8, x16, x32		
	AGC	0~10		
SCENE ENHANCE	WDR	MODE MODE	DOL, FRAME	
		ROI MODE	OFF, BOX, POLYGON	
		WEIGHT	LOW, MIDDLE, HIGH	
	NORMAL			
	HLC	LEVEL, COLOR		
	BLC	H/V-POS, H/V-SIZE		
3D-NR	OFF, LOW, MIDDLE, HIGH			
DAY / NIGHT	EXTERN	SMART IR, ANTI-SAT., DELAY, IR LED CTL		
	AUTO	SMART IR, ANTI-SAT., AGC THRES, AGC MARGIN, DELAY		
	COLOR			
	COLOR DN			
	B&W	SMART IR, ANTI-SAT.		
PICT. ADJUST	WHITE BAL.	AUTO, AUTOext, PRESET, MANUAL (C-TEMP, R/B-GAIN)		
	SHARPNESS	0~10		
	COLOR GAIN DAY	0~20		
	COLOR GAIN NIGHT	0~20		
	GAMMA	0.45, 0.55, 0.65, 0.75		
	D-WDR	OFF, LOW, MIDDLE, HIGH		
	DEFOG	OFF, ON	MODE, LEVEL	
	SHADING	OFF, ON		

SPECIAL	MIRROR / FLIP	OFF, HV, Hor., Ver.		
	PRIVACY	BOX	ZONE NUM, ZONE DISP, H/V-POS, H/V-SIZE, MASK COLOR, TRANSPARENCY	
		POLYGON	ZONE NUM, ZONE DISP, POS 0-X/Y, POS 1-X/Y, POS 2-X/Y, POS 3-X/Y, MASK COLOR, TRANSPARENCY	
	DIS	OFF, ON	RANGE	10% ~ 30%
			FILTER	LOW, MIDDLE, HIGH
AUTO-C			OFF, HALF, FULL	
CAM TITLE	OFF, RIGHT UP, LEFT DOWN			
SYSTEM	TV SYSTEM	EU(PAL), US(NTSC)		
	RESOLUTION	1440 30P/25P, 1080 30P/25P, 720 30P/25P		
	SDI MODE	HD-SDI, EX-SDI 1.0, EX-SDI 2.0, OFF		
	ANALOG MODE	TVI MODE	UTC TYPE (PELCO-C, HIK-C), HD ANALOG GAIN	
		AHD MODE	HD ANALOG GAIN	
	LANGUAGE	ENG, CHN(S), CHN, JPN, KOR, GER		
	COMM.	CAM ID, BAUDRATE		
RESET	ON			
EXIT	SAVE, CANCEL			

i Supported resolution according to Video format.

	1440P (30/25P)	1080P (30/25P)	720P (30/25P)
EX-SDI	○	○	○
HD-SDI		○	○
AHD mode	○	○	
TVI mode	○	○	○

OSD Menu Startup

Press the 'OSD menu SET key' down to access the setup menu mode.

- RETURN : Returns to the previous menu.
- EXIT : Exits the current menu with SAVE or CANCEL.

MENU V1. XX	
1. ZOOM/FOCUS	↵
2. EXPOSURE	↵
3. SCENE ENHANCE	WDR ↵
4. 3D-NR	MIDDLE
5. DAY/NIGHT	EXTERN ↵
6. PICT. ADJUST	↵
7. SPECIAL	↵
8. SYSTEM	↵
9. EXIT	SAVE ↵

1. ZOOM/FOCUS

1. ZOOM/FOCUS	
ZOOM	↵
FOCUS	↵
RETURN	↵



ZOOM	
ZOOM SPEED	FAST
POI ZOOM	ON ↵
PRESET ZOOM	ON ↵
SMART MOTION ZOOM	OFF
HOME POSITION	OFF
RATIO DISP	OFF
RETURN	↵

1-1. ZOOM

1-1-1. ZOOM SPEED : Set the zoom speed SLOW, MID, FAST

1-1-2. POI ZOOM (Point Of Interest) : ON enables to set the interest area which can zoom in/out the center area of video image.

- H-POINTER : Sets the horizontal location of area to be zoomed by POI ZOOM.
- V-POINTER : Sets the vertical location of area to be zoomed by POI ZOOM.

1-1-3. PRESET ZOOM : Able to zoom in for the preset area

- ZONE NUM : Set a number to select a preset zoom from 1 to 4
- ZONE VIEW : ON enables a relevant preset zone.
- H / V -POINTER : Adjust position of preset zone.
- ZOOM RATIO : Set the Optical/Digital Zoom Ratio.

Zoom ratio is automatically calculated according to the location of pointer.

POI ZOOM	
H-POINTER	29
V-POINTER	15
RETURN	↵

PRESET ZOOM	
ZONE NUM	1
ZONE VIEW	ON
H-POINTER	15
V-POINTER	8
ZOOM RATIO	OZ X1.1
RETURN	↵

SMART MOTION ZOOM	
ZONE NUM	1
WINDOW USE	ON
MOTION WIN SET	OFF
H-POINTER	15
V-POINTER	8
ZOOM RATIO	OZ X1.0
DURATION	5 SEC
SENSITIVITY	10 
RETURN	↵

1-1-4. SMART MOTION ZOOM : ON enables to Automatic Zoom IN/OUT when motion is detected and also enables MOTION WIN SET to ON.

Smart Zoom is not supported when FOCUS mode Manual /AUTO is used.

- ZONE NUM : Set a number to select a smart motion zoom from 0 to 3.
- WINDOW USE : Sets ON/OFF motion detection and zoom in/out area which you selected zone number.
- MOTION WIN SET : Sets ON or OFF to display the relevant motion zone.
- H / V -POINTER : Adjusts the detection area H,V position which you selected zone.
- ZOOM RATIO : Set the Optical/Digital Zoom Ratio.
- DURATION : Sets the duration time for zooming by Motion.
- SENSITIVITY : Adjusts the detection sensitivity for motion.
High value increases the sensitivity to detect the small motion easily.

1-1-5. HOME POSITION : Camera can be configured to return to pre-defined Zoom position automatically after certain period since ZOOM IN/OUT control is accomplished. Home Position is recovered even after camera is re-initializing or Power ON/OFF.

- O-ZOOM RATIO : Sets the Optical ZOOM position as Home Position. X1.0~X3.0
- DURATION : When ZOOM IN/OUT control is accomplished, camera returns to pre-defined Zoom position after Duration time.

1-1-6. RATIO DISP : ON enables to display the zoom ratio on the bottom right corner. OZx.x appears during the optical zoom and DZx.x will display by multiplying the optical zoom ratio and the actual digital zoom ratio.

1-2. FOCUS

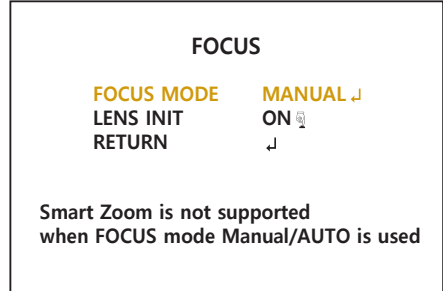
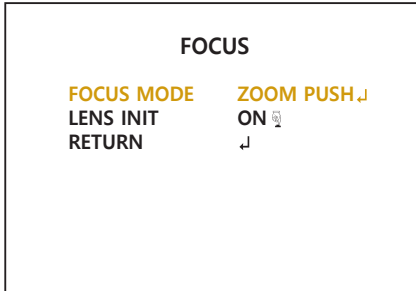

1-2-1. FOCUS MODE

Selects FOCUS MODE to ZOOM PUSH, AUTO or MANUAL. If you set to AUTO or MANUAL mode, Smart Motion Zoom function in ZOOM is disabled.

- ZOOM PUSH : Focusing is activated only when zoom in/out is working. Focusing works steadily for sharp focusing on the object.
- AUTO : Focusing is always working.
- MANUAL: Focusing can only be adjusted by ▲, ▼ of OSD control joystick or the remote control via UTC.

i Smart Zoom is not supported when FOCUS mode Manual/Auto is used.



1-2-2. LENS INIT :

Lens initialization is necessary during the installation or the regular operation to align the position data with the mechanical positions whose lens elements may move and deviate from its calibrated position by the shock or vibration, for example, during the transportation. Lens initialization is automatically executed at power up.

INITIAL starts the lens initialization when pressing the joystick straight down for about 2 sec. It is strongly necessary to execute LENS INIT in cases below;

- At the final step for the installation.
- When focus becomes out of control by the shock or vibration.

2. EXPOSURE

2. EXPOSURE	
MODE	AUTO
BRIGHTNESS DAY	10 
BRIGHTNESS NIGHT	10 
SENS-UP	X2
AGC	8 
RETURN	↵

2-1. MODE

Selects EXPOSURE MODE to AUTO, IRIS PRIOR, SHUT. PRIOR, MANUAL and Flickerless. If you set to WDR in SCENE ENHANCE menu, SHUT. PRIOR, MANUAL and FLICKERLESS modes are disabled.

2-1-1. AUTO : Optimizes the video level by controlling the iris and the shutter speed automatically.

2-1-2. IRIS PRIOR : Selects to fix IRIS in a certain aperture and the video level is controlled by an automatic shutter control. Lower IRIS LEVEL will close more iris and increase the field of depth in the daytime but significantly decrease the low light performance. Too much low IRIS LEVEL will result in the foggy video by the diffusion from the lens iris.

2-1-3. SHUT PRIOR : Selects to fix SHUTTER speed in a certain speed and the video level is controlled by an automatic iris control. This mode is useful when the color rolling occurs under the fluorescent lighting. It is not recommendable at outdoor in the daytime.

2-1-4. MANUAL : Iris level and Shutter speed can be set to fix.

- IRIS LEVEL : 0~17
- SHUT SPEED : 1/30(1/25), 1/60(1/50), 1/120(100), 1/250(200), 1/500(400), 1/1000(800), 1/2000(1600), 1/4000(3200), 1/8000(6400), 1/15000(12800), 1/30000(25600)

2-1-5. FLIKERLESS : Reduces the flicker in video when US(60Hz)/EU(50Hz) mode is used in 50Hz/60Hz fluorescent lighting respectively.

2-2. BRIGHTNESS DAY

Adjusts the brightness of video in DAY mode (0~20).

2-3. BRIGHTNESS NIGHT

Adjusts the brightness of video. It works in COLOR D/N, NIGHT mode (0~20).

2-4. SENS-UP

The brighter video can be obtained by increasing the exposure time in the night with SENS-UP. It can be set to Off, x2, x4, x8, x16 or x32.

Higher setting can get the brighter video but the slower frame rates with more white pixels.

2-5. AGC

AGC(0~10) amplifies the video gain for brighter video but noise and white pixel accordingly.

3. SCENE ENHANCE

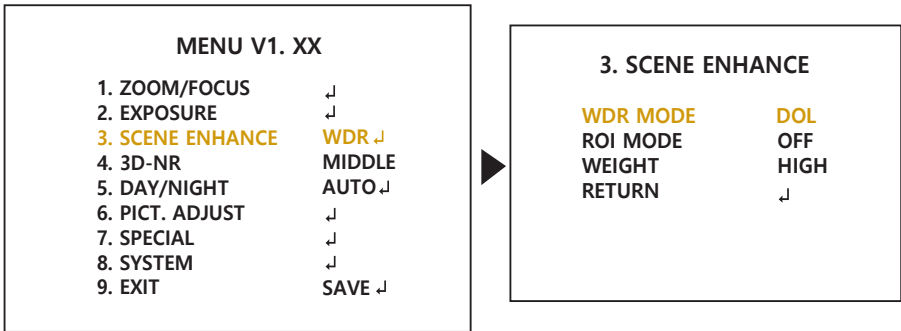

3-1. WDR (Wide Dynamic Range)

WDR is extended the gain range of the video that is mostly useful if camera takes a simultaneous picture of both indoor and outdoor nearby window.

It improves contrast of the picture in outdoor scenery as well as indoor.

Video outputs image processed from two images by dual shutter (long and short shutter) in a field to provide the best dynamic range. Highlight area is compensated by the short shutter and dark area is compensated by the long shutter. Final video may have less contrast compared to the conventional camera which does not have WDR function.

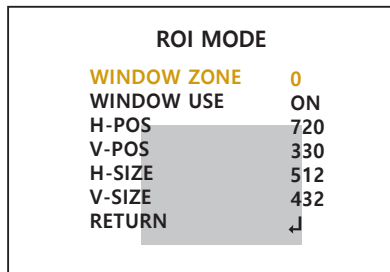

3-1-1. WDR MODE

- DOL (Digital OverLap): It is compensated video image by 3 layer data of low, middle and high shutter.
- FRAME : It is conventional WDR mode.

3-1-2. ROI MODE (Region Of Interest) : Sets specific area of WDR by window setting. Select window zone number from 0 to 3 and window use set to on. Then the window zone can be modified position and size.

- WINDOW ZONE : Set the detection zone number from 0 to 3.
- WINDOW USE : Sets ON/OFF motion detection area which you selected. If set to ON, It can be adjusted position and size.
- H/V-POS : Adjusts the ROI area H, V position which you selected zone.
- H/V-SIZE : Adjusts the area size using H, V direction which you selected zone.

3-1-3. WEIGHT : LOW, MIDDLE, HIGH

Selects the WDR value that you set the WDR mode.

3-2. NORMAL

Optimized for the normal indoor and outdoor in the good lighting condition.

3-3. HLC (High Light Compensation)

Cuts out the highlight area with mask and excludes it from compensation.

3-3-1. LEVEL (0~20): Sets the HLC level.

It determines the video level that starts cutting out. Lower setting starts the cut out at lower level. The cut out area is masked with selected color.

3-3-2. COLOR :

Select mask color from 8 colors. Black, White, Yellow, Cyan, Green, Magenta, Red, or Blue.

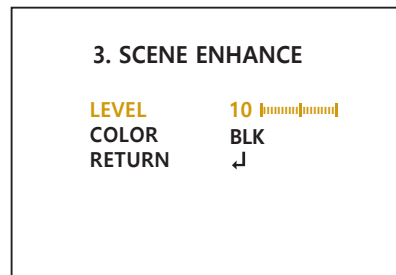

3-4. BLC (Backlight Compensation)

This function is used to brighten an image in the foreground with a highly light area behind it such as sunlight, limiting the affect of silhouette.

BLC has a target window for compensation and its size and position can be set by H-POS, V-POS, H-SIZE and V-SIZE.

3-4-1. H/V-POS : Sets the position of BLC area to move vertically and horizontally.

3-4-2. H/V-SIZE : Sets the size of BLC area to move vertically and horizontally.

4. 3D-NR (Digital Noise Reduction)

DNR function improves picture quality by filtering out signal noise which is generated under the low light conditions. Sets off, low, middle or high level.

3DNR(3-dimensional noise reduction) which reduces the noise by the multi frames. It is effective at low light. Setting high is strength of noise reduction but the result may occur in loss of sharpness and the tail effect of a comet.

MENU V1. XX	
1. ZOOM/FOCUS	↓
2. EXPOSURE	↓
3. SCENE ENHANCE	WDR ↓
4. 3D-NR	MIDDLE
5. DAY/NIGHT	AUTO ↓
6. PICT. ADJUST	↓
7. SPECIAL	↓
8. SYSTEM	↓
9. EXIT	SAVE ↓

5. DAY & NIGHT

DAY/NIGHT is used to control the setting during day-time and night-time operation. Select the mode according to the light condition and the camera types.

5-1. EXTERN

DAY or NIGHT is determined by the built-in light photo sensor. Camera with IR LED must be set to EXTERNAL.

5. DAY&NIGHT	
SMART IR	ON
ANTI-SAT.	10 
DELAY	MIDDLE
IR LED CTRL	AUTO
RETURN	↓

5-1-1. SMART IR

SMART IR can be set to reduce the saturation by the strong IR illumination in the night in any menu of EXTERN, AUTO and B/W(NIGHT). Set to ON, SMART IR is enabled and ANTI-SAT. level is controlled.

5-1-2. ANTI-SAT. (Available only with the SMART IR is ON)

Sets the anti saturation level 0~20. Setting high level avoids the saturation strongly but the corners will be darker accordingly.

5-1-3. DELAY



D→N DELAY is time in second while camera maintains its status before Day to Night switches. DELAY can avoid the unwanted/frivolous switching by a short term lights such as light from the passing car. Sets delay term low, middle or high.

5-1-4. IR LED CTL

IR LED Control (AUTO/OFF) is available with IR LED model only. If it is set to OFF, IR LED will be turned OFF but DAY or NIGHT is still determined by the built-in light photo sensor.

5-2. AUTO

Used when DAY or NIGHT is determined by light level through the lens and DAY from/to NIGHT is switched automatically by the scene brightness. It can be controlled the AGC threshold level, AGC margin and delay time.

5. DAY&NIGHT	
SMART IR	OFF
ANTI-SAT.	NOT USED
AGC THRES	10 
AGC MARGIN	15 
DELAY	MIDDLE
RETURN	↓

5-1-1. SMART IR

SMART IR can be set to reduce the saturation by the strong IR illumination in the night in any menu of EXTERN, AUTO and B/W(NIGHT). Set to ON, SMART IR is enabled and ANTI-SAT. level is controlled.

5-1-2. ANTI-SAT. (Available only with the SMART IR is ON)

Sets the anti saturation level 0~20. Setting high level avoids the saturation strongly but the corners will be darker accordingly.

5-2-3. AGC THRES

AGC(Auto Gain Control) is a threshold level which determines to switch DAY from/to NIGHT in AUTO mode. Higher value makes the camera switch DAY from/to NIGHT at bright illumination.

5-2-4. AGC MARGIN

Sets the gap level switching from/to DAY(color) or NIGHT(B/W).

5-2-5. DELAY

D→N DELAY is time in second while camera maintains its status before Day to Night switches. DELAY can avoid the unwanted/frivolous switching by a short term lights such as light from the passing car. Sets delay term low, middle or high.

5-3. COLOR

The camera is always in COLOR mode.
Forcibly DAY/NIGHT is disabled and outputs color video.



5-4. COLOR DN

Forcibly Color mode, optimized for night condition. It is available to recognize colors of car, people and moving objects even at night. Parameters can be controllable & programmable according to circumstance. Application for bright circumstance at night such as downtown, civic area, street, mall and etc.

5-5. B&W

The camera is always in B/W mode.
Forcibly removes IR cut filter and switches to B/W regardless of light level.

6. PICT. ADJUST

6. PICT. ADJUST	
WHITE BAL	AUTO
SHARPNESS	5 
COLOR GAIN DAY	10 
COLOR GAIN NIGHT	10 
GAMMA	0.55
D-WDR	OFF
DEFOG	OFF
SHADING	OFF
RETURN	↓

6-1. WHITE BAL

Automatically tracks the changes of color temperature and continuously adjusts the white balance. AUTO, AUTOext, PRESET and MANUAL modes are available.

6-1-1. AUTO : Optimized for Indoor installation and more easily compensates AWB for low color temperature such as incandescent lights.

6-1-2. AUTOext : Optimized for outdoor sunlight applications and more easily compensates AWB for high color temperature such as sunlight.

6-1-3. PRESET : AWB is performed only whenever ● is pressed.

6-1-4. MANUAL : White balance is fixed to the settings by Color-Temperature Red-GAIN and Blue-GAIN. It can be used only when the color temperature does not vary.

6-2. SHARPNESS

Sets the Sharpness level 0~10. Increases or decreases the sharpness of the picture. Too much sharpness can make image harsh and show more noise as well as line flicker at the edge of object in the picture.

6-3. COLOR GAIN DAY

Sets the color gain control level in DAY mode. (0~20)

6-4. COLOR GAIN NIGHT

Sets the color gain control level. It works in COLOR D/N, NIGHT mode. (0~20)

6-5. GAMMA

Adjust gamma level of video. If you set to WDR in SCENE ENHANCE menu, GAMMA mode is disabled.

6-6. D-WDR

Improves the visibility for the high bright area and the dark area by compensating the video gain. Care should be taken to select low, middle or high level because video may lose its quality in some environments by the over compensation.

Video noise can be increased in the dark area accordingly.

If you set to WDR in SCENE ENHANCE menu, D-WDR mode is disabled.

6-7. DEFOG

Enhance the foggy video according to status of scene. Video quality can be less in normal environments. If you set to WDR in SCENE ENHANCE menu, DEFOG mode is disabled.

6-7-1. MODE

- AUTO : Enhance the foggy video automatically according to status of scene.
- MANUAL : Sets to enhance the foggy video manually regardless of status of scene.

6-7-2. LEVEL : Sets Low, Mid or High. Video quality can be less in normal environments.

6-8. SHADING

ON enables to compensate the shade caused by wide lens setting.

Sets shading WEIGHT from 0% to 100%.

If you set to WDR in SCENE ENHANCE menu, SHADING mode is disabled.

7. SPECIAL

7. SPECIAL	
MIRROR/FLIP	OFF
PRIVACY	↓
DIS	ON ↓
CAM TITLE	OFF
RETURN	↓

7-1. MIRROR/FLIP

Reverses the video left and right and/or up and down by MIRROR/FLIP. When the video is reversed by Ver. or HV, then the joystick directions are reversed accordingly. This feature is very useful when a camera is installed in upside down.

- OFF : Normal display without mirroring or flipping
- HV : Video is reversed left and right and upside down.
- Hor. : Video is reversed left and right
- Ver. : Video is reversed upside down

i POI, Preset, Smart Zoom are not supported when Mirror/Flip is used.

7-2. PRIVACY

Sets ON/OFF for enabling/disabling PRIVACY mask. 16 privacy areas are available and each area is programmable in size, color, position and transparency.

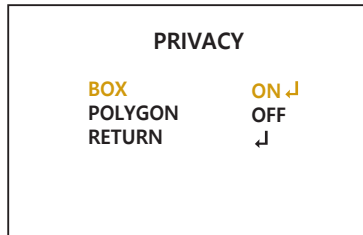

7-2-1. BOX

- ZONE NUM : Selects mask zone number from 0 to 3 to be adjusted.
- ZONE DISP: Displays OFF/ON for the mask area which you selected zone.
- H-POS, V-POS: Adjusts the mask area H, V position which you selected zone.
- H-SIZE, V-SIZE: Adjusts the mask size using H,V direction which you selected zone.
- MASK COLOR : Adjusts the mask color by LEVEL.
(0: Black, 1: White, 2: Red, 3: Green, 4: Blue, 5: Blue-Green, 6: Yellow, 7: Violet)
- TRANSPARENCY : Selects transparency rate for the mask area. (OFF~100%)

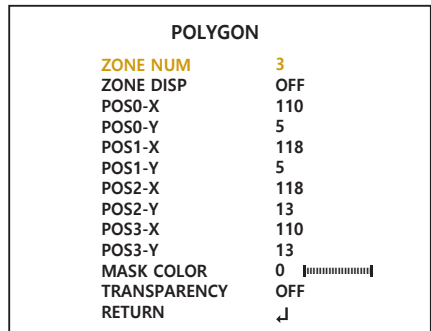
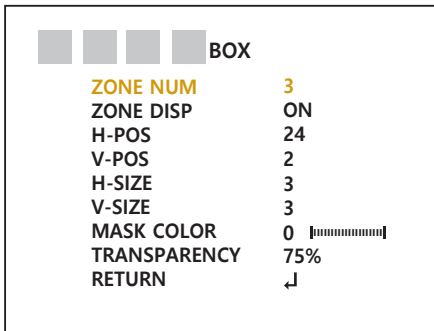

7-2-2. POLYGON

- ZONE NUM : Selects mask zone number from 0 to 3 to be adjusted.
- ZONE DISP: Displays OFF/ON for the mask area which you selected zone.
- POS0-X,Y~POS3-X,Y : Adjusts the mask area H, V position and make polygon shape which you selected zone.
- MASK COLOR : Adjusts the mask color by LEVEL. (0: black ~ 20: white)
(0: Black, 1: White, 2: Red, 3: Green, 4: Blue, 5: Blue-Green, 6: Yellow, 7: Violet)
- TRANSPARENCY: Selects transparency rate for the mask area. (OFF ~ 100%)

7-3. DIS (Digital Image Stabilization)

- 7-3-1. RANGE : Sets the image compensation range. 10%, 20%, 30%.
Higher values attempt to stabilize the image against big displacement but the field of view is narrowed.
- 7-3-2. FILTER : LOW, MIDDLE, HIGH
Sets the sensitivity to initiate DIS function.
- 7-3-3. AUTO-C : OFF, HALF, FULL
Sets how to align video at center after finishing the stabilization.

7-4. CAM TITLE

Camera title(name) can be set and edited with alphanumeric characters. Select the camera title position 'LEFT DOWN' or 'RIGHT UP' on the video.

Then ◀, ▶ moves the cursor and ▲, ▼ choose a character to select it.

The selected characters are added and displayed on the input line.

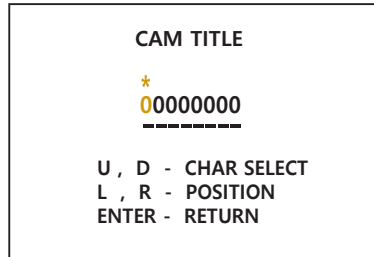

8. SYSTEM

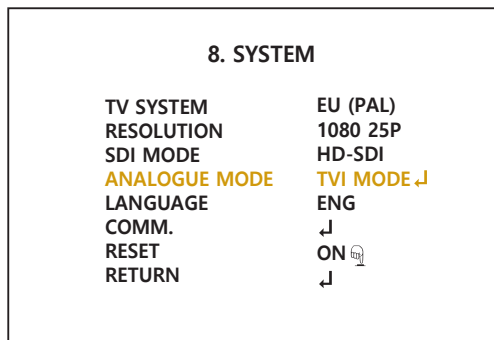

8-1. TV SYSTEM

Selects HDTV standards for analog video output switches to 60HZ, US(NTSC) or 50HZ, EU(PAL) accordingly.

8-2. RESOLUTION

Select the video resolutions, 1440P/1080P/720P are available.

8-3. SDI MODE

HD-SDI or EX-SDI is selectable by video format switch on OSD board only.

8-4. ANALOG MODE

Selects HD-ANALOG modes TVI MODE or AHD MODE.

If set to TVI MODE, it can be selected PELCO-C or HIK-C in UTC TYPE.

HD ANALOG GAIN enables to control brightness of video according to transmission distance.

8-5. LANGUAGE

6 languages are available for OSD menu.







English, Korean, Japanese, Chinese(S), Chinese, German.

8-6. COMM. : Defines the CAM ID, BAUD RATE.

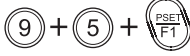
- CAM ID: Assigns the camera ID from 1~254 for the comm. address.
- BAUD RATE: Selects the baud rate from 2400~115200.
- Default protocol for RS-485 is PELCO-D.

TIP

Setting for Zoom Function PTZ Controller Default protocol PELCO-D

- Enter the MENU :
Press buttons 9+5+PSET (PRESET) 
- Set the Preset Zoom :
Press buttons 1(or ~4)+PSET (PRESET) 
- Move the cursor in the MENU :
Moves UP/DOWN/LEFT/RIGHT Joy stick 
- Zoom IN: Press button TELE or Spin the joystick to clockwise.
- Zoom OUT: Press button WIDE or Spin the joystick to counter-clockwise. 
- Select or Choose value in the MENU :
Press button OPEN (IRIS OPEN) 
- Exit the Preset Zoom mode :
Press buttons 3+4+PSET (PRESET) 

8-7. RESET : Loading Factory Default.

9. EXIT : Exits SETUP MENU and returns to the normal display.

9-1. SAVE : Save all the setting and exit the setup menu.

9-2. CANCEL : Exit the setup menu without save.

EN

Further information

The manual is also available from the eneo web site at www.eneo-security.com.



eneo® is a registered trademark of
VIDEOR E. Hartig GmbH
Exclusive distribution through specialised
trade channels only.

VIDEOR E. Hartig GmbH
Carl-Zeiss-Straße 8
63322 Rödermark/Germany
Tel. +49 (0) 6074 / 888-0
Fax +49 (0) 6074 / 888-100
www.videor.com
www.eneo-security.com

Technical changes reserved

© Copyright by VIDEOR E. Hartig GmbH
Version 07/2018