



## IPP-82A0030MHA

Article number: 216306

1/1.9" Network Dome, 1920x1080, Day&Night, PTZ, 6,0-180mm, Infrared, IP66

### Mainfeatures

High sensitive 1/1.9" Sony Exmor CMOS chipset

Up to 500m IR Illumination

30x AF Zoom, 6,0~180mm / Digital zoom

Compression H.264/MJPEG, Web Casting

VCA Video Analytic, Privacy zones

Alarm in- and outputs, micro SD card slot

Low Light Enhancement Technology

Zoom synchronized & fixed LEDs

Full HD, 1920x1080 pixels, 1080p@50/60fps

Digital noise reduction (DNR)

Real time WDR (Wide Dynamic Range) 25/30fps

High-PoE midspan included

### Specifications

#### Camera:

Sensor size	1/1.9"
Resolution standard	HD 1080p
Imager	CMOS, Sony Exmor, Sensor IMX185
System	True Day&Night
Sensitivity	0,1 Lux, at F1.6, 50 IRE
Low speed shutter	yes, 2x ~ 8x
Manual electronic shutter (MES)	1/25 ~ 1/30.000sec
Automatic electronic shutter (ESC)	1/25 ~ 1/30.000sec.
Wide Dynamic Range (WDR)	WDR 120dB, Real Time WDR 25/30fps
Backlight compensation	BLC, HLC
Day/Night switching	auto, day, night

# IPP-82A0030MHA

## Continued Specifications

IR cut filter	switchable
White balance	automatic, outdoor, manual, fluorescent, Light bulb
<b>Video:</b>	
Resolution	1920x1080 (16:9), 1280x1024 (5:4), 1280x960 (4:3), 1280x720 (16:9), 1024x768 (4:3), 704x576 (4:3), 704x480 (4:3), 640x480 (4:3), 640x360 (16:9), 320x240 (4:3)
Resolution max.	1920x1080
Stream types	2x H.264, 1x MJPEG multiple
Image transmission rate max.	60 fps
Multicast compliant	yes
Compression standard	H.264, M-JPEG
<b>Lens:</b>	
Lens type	auto focus zoom
Zoom factor	30x
Focal length	6 - 180 mm
Digital zoom	16x
MOD (Minimum object distance)	0,5 m
Iris control	DC
Vertical angle of view	33,2 - 1,7 °
Horizontal angle of view	58 - 3,1 °
<b>Features:</b>	
Motion detector	yes
Analysis functions	motion detection, tampering protection, trip wire detection with counting and direction detection, Field detection, face detection, Defog
Alarm processing	recording internal storage, E-Mail, FTP, Boost, HTTP, TCP, UPD, HTTPS, XML, alarm out
Presets	256 presets
Rotation range	360 °
Speed (manual control)	380 °/Sek.
Vertical tilt range	-10° ~ +90°
Audio	2 Way Audio
Audio support	yes
Internal storage	microSDHC card, microSDXC card
Menu languages	English, German, French, Russian, Chinese, Korean, Japanese
Privacy zones masking	Areas-ON/OFF switchable
Remote configuration	web browser
Web browser	MS internet Explorer: ActiveX ex 9.0, Safari: MJPEG setup limited, Mozilla: MJPEG setup limited, Google: MJPEG setup limited, Edge: MJPEG setup limited
User interface	Type B (white / blue)
Mirror function	H-flip
Digital Noise Reduction (DNR)	yes
<b>Network:</b>	
Network protocols	TCP/IP, UDP, IPv4, IPv6, HTTP, HTTPS, FTP, UPnP, RTP, RTSP, RTCP, DHCP, ARP, Zeroconf, Bonjour, QoS

# IPP-82A0030MHA

## Continued Specifications







<b>Interfaces / Inputs / Outputs:</b>	
External connections	12VDC input (DC plug), RJ-45, alarm input/output, audio input/output, connection cable approx.25cm
Ethernet interface	10Base-T, 100Base-TX
Alarm inputs	4
Alarm outputs	1
<b>General:</b>	
Series	eneo Premium Class
Dimensions (HxWxD)	317,8x201.8mm
Illumination	infrared, Zoom Synchronized & Fixed IR LED, 5~60°
Illumination range	approx. 400~500m
Colour (housing)	Pantone Cool Gray 1C
Housing	outdoor
Housing material	aluminium, plastic
Weight	5.1kg
Heater	no
Camera type	PTZ Dome
Power consumption	28W
Mounting	wall mount, ceiling mount
ONVIF	ONVIF Profile S
Protection rating	IP66
SDK	upon request
Supply voltage	Ultra PoE, 12VDC
Temperature range (operation)	-30°C ~ 65°C
Text display	supplied
Vandalism resistant	no
<b>Scope of delivery:</b>	
Parts supplied	manual, mounting accessories, High-PoE-Midspan, eneo Site Manager
<b>Notes:</b>	
Remarks	To ensure a faultless PoE operation, please use only the supplied Ultra PoE Midspan of accessories pack.

### Special features

Video analytic function, Anti-moisture coating of camera window  
 Outdoor-ready, High POE Midspan are scope of supply  
 Optional mounting accessories needed  
 Auto calibration (Origin Check)

# IPP-82A0030MHA

## Available Accessories

Image	Prod. No / Label	Description
	74127 / EDC-WMB1	Wall Mount for PTZ Dome Cameras with Mounting Kit
	74128 / EDC-CMT1	Ceiling Mount Tube with Flange Plate for PTZ Dome Cameras
	211976 / ECB-1	Media Converter, Indoor, 1x RJ45, 1x SFP
	211980 / EVX-900R	Media Converter, Indoor, Transmitter-Receiver, 1x RJ45, 1x RJ-11, 12V, up to 1000m
	211981 / EVX-900B	Media Converter, indoor, Transmitter-Receiver, 1x RJ45, 1x BNC, 12V, up to 1000m
	213474 / NE-128B	Voltage supply unit 230V/24V-5A, Plastic housing, IP66
	218218 / eneo Site Manager	Management Software for eneo IP Cameras

# IPP-82A0030MHA

## Technical Drawing

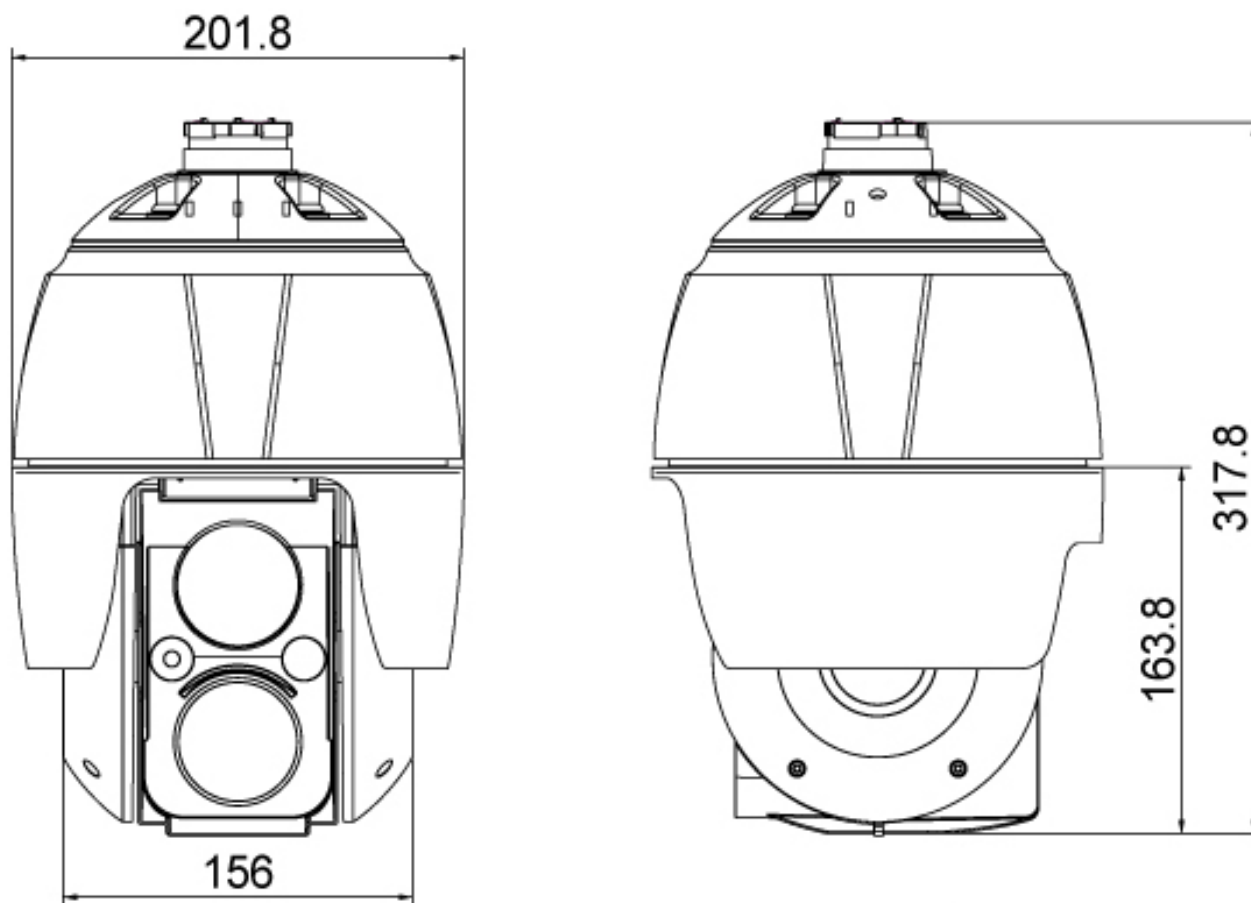

Dimensions: mm

## Your Contact Person



eneo is a registered trademark of  
VIDEOR E. Hartig GmbH  
Carl-Zeiss-Straße 8  
63322 Rödermark  
Deutschland  
Tel.: +49 6074-888-333  
E-Mail: info@eneo-security.com  
Web: www.eneo-security.com