



EN

User Manual

**1/2.8" Network Camera,
2048x1536, Day&Night, D-WDR,
2.7-12mm, Infrared, IP67**

ICB-73M2712MWA

Table of content

Parts supplied	5
Part names	6
Installation instructions	7
Cover Opening Alarm and External Alarm Input	7
Using Grommet	7
Using RJ45 Easy Cap for Network cable	8
Recommended cable length into the Junction box base	8
Pan & Tilt adjustments	11
How to access via Wi-Fi	13
General Description	15
Specification	16
Quick Network Setup	18
Further information	18
Full Menu Setup	19
Web viewer description	19
Setup Menu Table	20
LIVE VIEW	22
Player control & Display	22
Video stream & Protocol	22
PTZ Control	23
PLAYBACK	23
Event search	23
Timeline search	23
SETUP	25
Information	25
Video & Image	25
Audio	38
Record	39
Event	41
System	56
USER MANUAL	66
Troubleshooting	67

Safety instructions

General safety instructions

- Before switching on and operating the system, first read this safety advice and the operating instructions.
- Keep the operating instructions in a safe place for later use.
- Installation, commissioning and maintenance of the system may only be carried out by authorised individuals and in accordance with the installation instructions - ensuring that all applicable standards and guidelines are followed.
- Protect the devices from water penetration and humidity, since these can cause lasting damage.
- Should moisture nevertheless enter the system, under no circumstance switch on the devices under these conditions, instead send them for examination to an authorised specialist workshop.
- The system must never be used outside of the technical specifications, since this can destroy it.
- The device must be protected from excesses of heat, dust, humidity and vibration.
- When separating the system from the voltage supply, only ever use the plug to pull out the cable. Never pull directly on the cable itself.
- Lay the connecting cables carefully and check that they are not mechanically stressed, kinked or damaged and that no humidity can penetrate into them.
- In the event of a malfunction, please inform your supplier.
- Maintenance and repairs may only be carried out by authorised specialist personnel.
- The system must be isolated from the power supply before opening the housing.
- The device may only be opened by qualified service personnel. Unauthorised access invalidates any warranty claim.
- Connection cables should always be exchanged through Videor E. Hartig GmbH.
- Use only original spare parts and accessories from Videor E. Hartig GmbH.
- The housing should only be cleaned using a mild domestic cleaning agent. Never use solvents or petrol as these can permanently damage the surface.
- During installation, it is essential to ensure that the seals provided are correctly installed and that they are not displaced during installation. Damaged seals must not be installed and will invalidate any warranty.
- The installer is responsible for the maintenance of the enclosure as per the technical data, e.g. by sealing the cable outlets with silicone.
- Wire end ferrules should be used when shortening the flexible connection cables.
- The devices may only be operated in the temperature range indicated in the data sheet and within the defined air humidity range.

Product - Specific Safety Instructions

- The camera may never be pointed directly at the Sun with the aperture open (this will destroy the sensor).
- It is unavoidable that during manufacture and to a certain extent during later use, humidity will be present in the ambient air within the device's housing. In the event of large temperature fluctuations, this humidity may condense inside the housing.
- To avoid this condensation inside the very tightly sealed housing, the manufacturer has inserted silica gel sachets in the housing of the various camera types.
- It is however a physical given, that these silica gel bags will reach saturation after a certain amount of time. They should therefore be replaced with new silica gel sachets.
- During installation, it is essential to ensure that the seals provided are correctly installed and that they are not displaced during installation. Damaged seals must not be installed and will invalidate any warranty.
- A multipolar, easily accessible isolation device should be installed in the proximity of the IR Spotlight, in order to disconnect the device from the power supply for service work.
- The earth connection must be made according to the low impedance requirement of DIN VDE 0100.
- Subsequent painting of the equipment surface can impair the function.
- Any warranty claim is invalidated by subsequent painting.
- A safety margin of > 1m from the spotlight must be maintained when viewing directly into the IR Spotlight in a darkened environment.
- Do not look directly at invisible LED radiation using optical instruments (e.g. a reading glass, magnifying glass or microscope), since this can endanger the eyes, LED Class 1M.
- Operation of the IR spotlight with a defective cover or during repair is prohibited.

Class A device note

This is a Class A device. This device can cause malfunctions in the living area; in such an event, the operator may need to take appropriate measures to compensate for these.

WEEE (Waste Electrical & Electronic Equipment)

Correct Disposal of This Product (Applicable in the European Union and other European countries with separate collection systems).

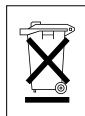

This marking shown on the product or its literature, indicates that it should not be disposed with other household wastes at the end of its working life. To prevent possible harm to the environment or human health from uncontrolled waste disposal, please separate this from other types of wastes and recycle it responsibly to promote the sustainable reuse of material resources. Household users should contact either the retailer where they purchased this product, or their local government office, for details of where and how they can take this item for environmentally safe recycling. Business users should contact their supplier and check the terms and conditions of the purchase contract. This product should not be mixed with other commercial wastes for disposal.

Graphical symbols

Please pay attention to the safety instructions, and carefully read through this instruction guide before initial operation.



Important points of warning are marked with a caution symbol.



Important points of advice are marked with a notice symbol.

Parts supplied

- Network Camera
- Operating Instruction
- Installation CD
- Mounting Template
- Cable Signal Sticker
- Plastic Anchor: 6 x 30mm (4x)
- Mounting Screw: 4 x 30mm (4x)
- Hex Wrench: 3mm (1x)
- Hinge Pin (1x)
- Cable Tie (2x)
- Grommet (2x)
- Cable fixation plate with Fixing screw
- RJ45 Easy Cap for Grommets

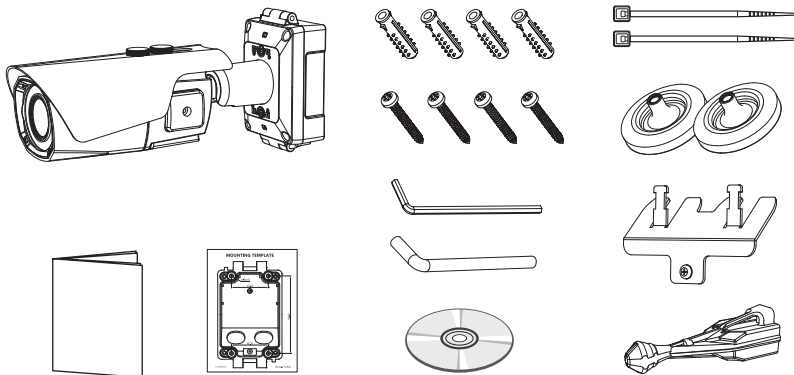

Part names

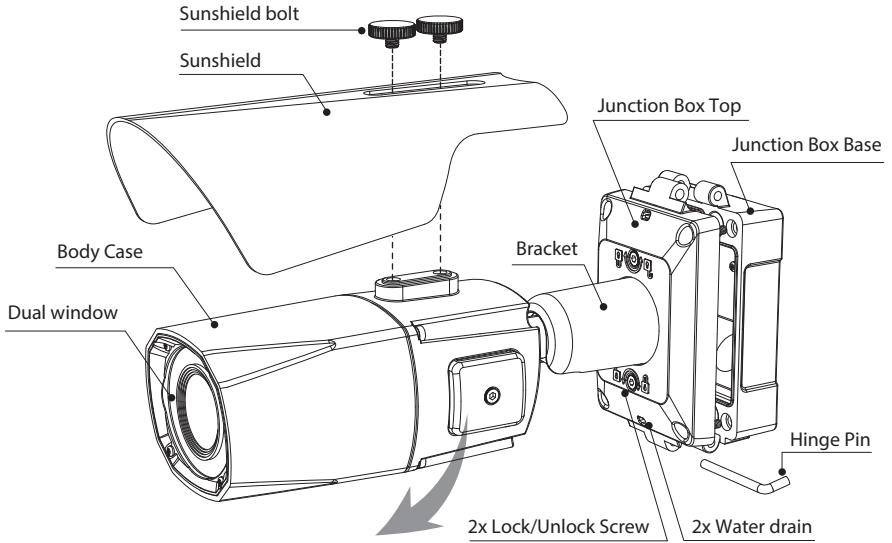

Inside of Opening Cover

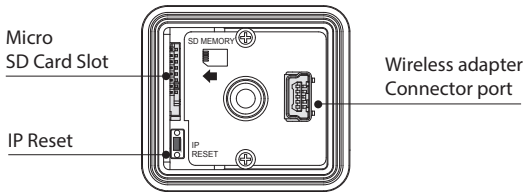

Junction Box Base

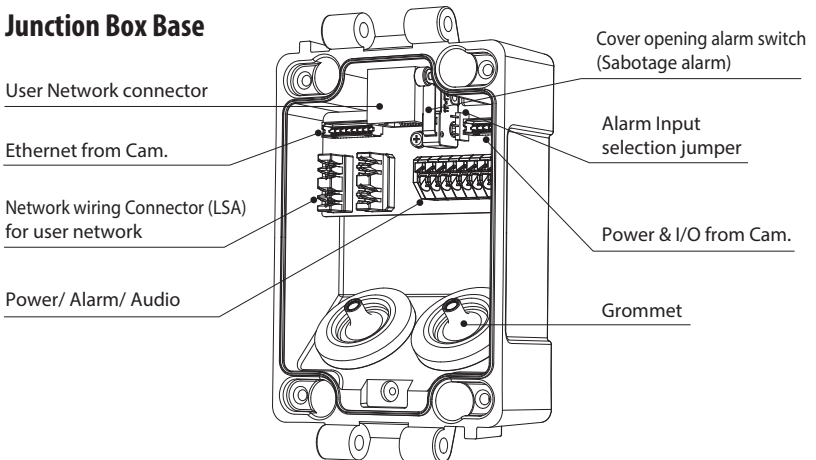

Installation instructions

Cover Opening Alarm and External Alarm Input



CAUTION: Cover Opening(Sabotage) Alarm and External Alarm Input are electrically tied together internally. Alarm contact types, N.O or N.C are selectable by the Alarm Input Selection Jumper and the selection types should be matched with Alarm Type in setup menu.

When both of Cover Opening Alarm and External Alarm Input are used at the same time, the alarm contact types must match. Otherwise, alarm malfunctions. When External Alarm Input only is used with disabling Cover Opening Alarm, remove the jumper cap of Alarm Input Selection Jumper.

For Cover Opening Alarm, please go to SETUP> Event Rules> Event Processing> Add Event Trigger should be set to "Alarm In" and then Event Action should be set as available options.

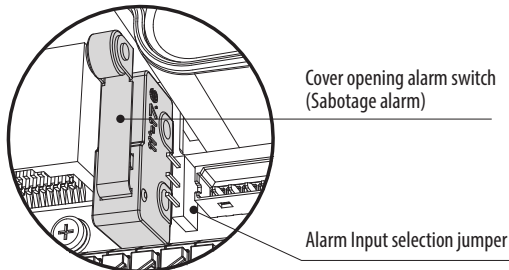

Using Grommet

Tear off the cocks of grommets properly and pull up the grommet so that sealing can wrap the cable properly as illustrated. If it doesn't wrap the cable properly, it could cause the water leakage problem.

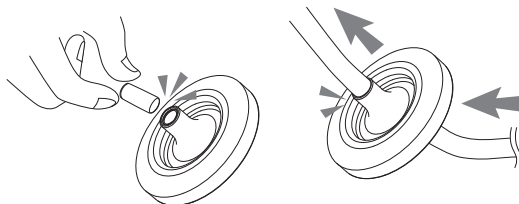

Using RJ45 Easy Cap for Network cable

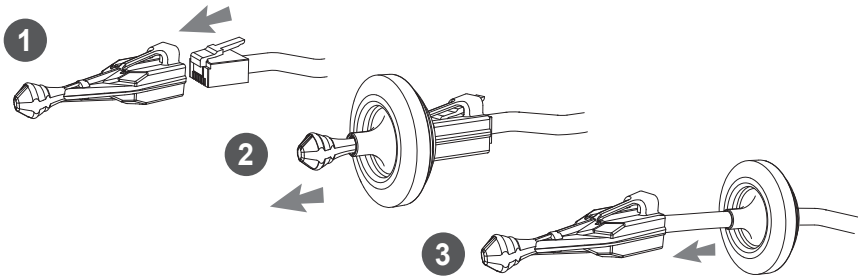

Recommended cable length into the Junction box base

- CABLE with RJ-45 Connector: 70mm~80mm
- CABLE for Network Wiring Connector: 20mm~30mm (excluding cable tripping section) 8P cable stripping distance: 20mm~30mm
- Power CABLE: 20mm~30mm (excluding cable tripping section) 8P cable stripping distance: 20mm~30mm

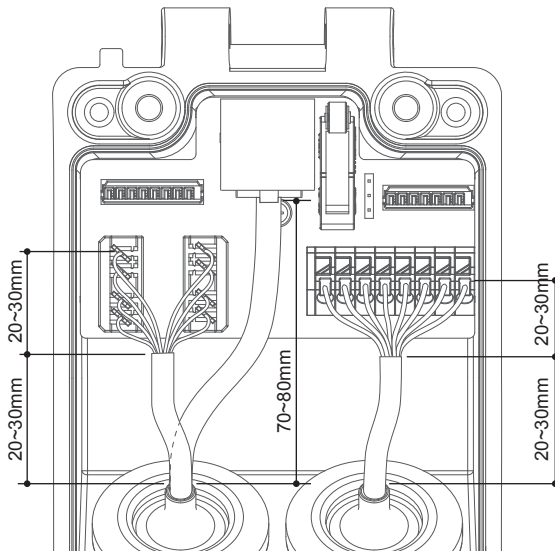

Install the mount onto a strong structure.

Prepare the Junction box base and the accessories for installation.

1. Locate the mounting template at the installation position and drill the ceiling or wall if needed.
2. Route the Power/Ethernet cables through the grommets from the wall. Insert the grommets onto the Junction box base.
3. Place the Junction box base on pre-drilled position and fix it through using mounting screws (4x30mm).

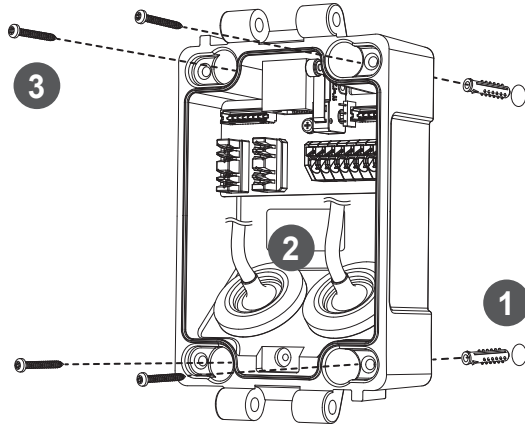

4. Hook up the Power & I/O wires and Network cable to the connectors. Network cable can be connected to either RJ-45 connector or LSA connectors.

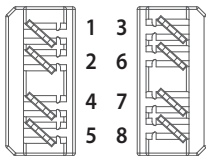

TIA/EIA 568A	TIA/EIA 568B
1. Green-White	1. Orange-White
2. Green	2. Orange
3. Orange-White	3. Green-White
4. Blue	4. Blue
5. Blue-White	5. Blue-White
6. Orange	6. Green
7. Brown-White	7. Brown-White
8. Brown	8. Brown

Connections to LSA connectors

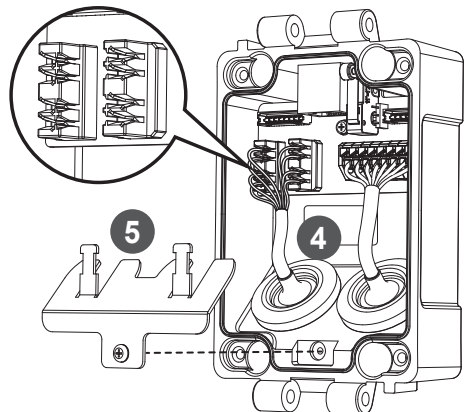

5. Fix the cable fixation plate and tie up the cable to it.
6. Assemble the Junction box top to the Junction box base using a hinge pin. Hinge can be inserted at either side for convenience.
7. Connects the Power/Ethernet cables from camera.
8. Set Alarm Input Selection Jumper. (Refer to 'Cover Opening Alarm and External Alarm Input')
9. Cover the Junction box top and tighten with assembly screws (4pcs).

*** Caution: If assembly screws are not firmly assembled, it causes water leakage.**

Connections to RJ-45 connector

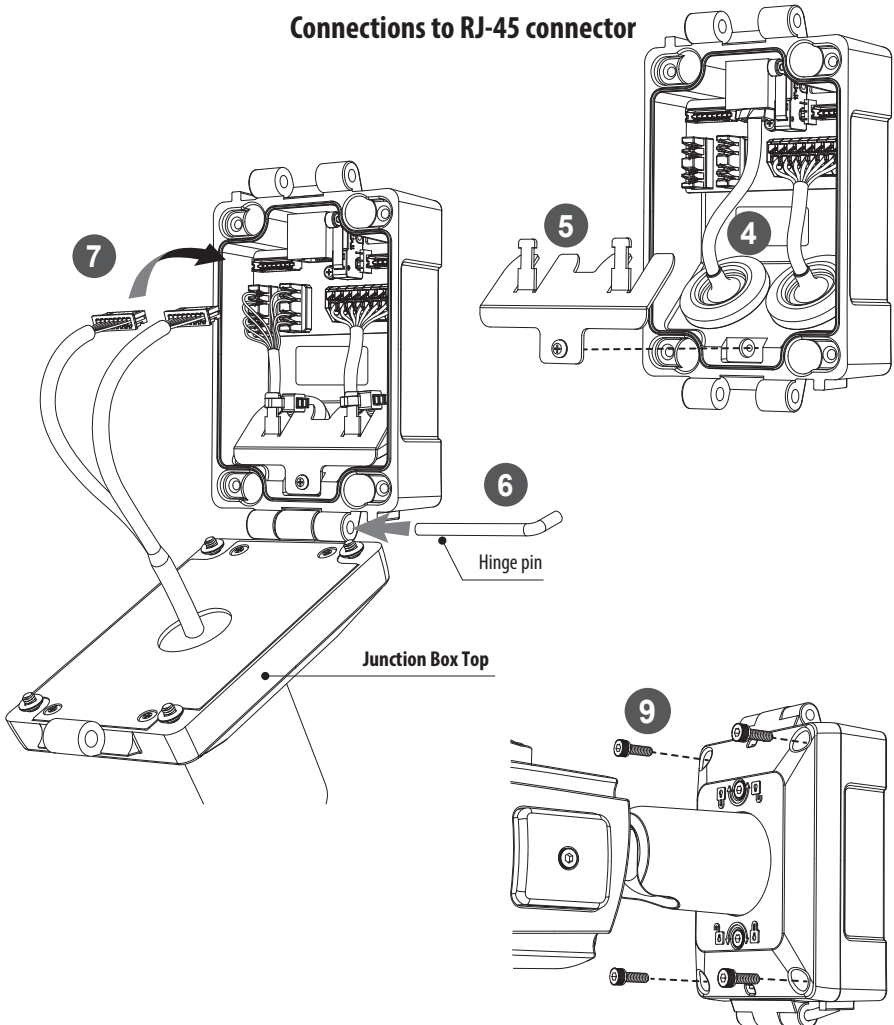

10. Set the camera's orientation and tighten the Lock/Unlock screws using hex wrench.
11. Open the Opening cover to insert the Micro SD memory and/or connect the wireless adapter cable. (Refer to 'How to access the camera through the wireless connection' for more information)
12. After all the setting, close the Opening cover and tighten it.
13. Put the sunshield to the camera unit and tighten the sunshield bolts.



CAUTION:

Extreme care should be taken NOT to scratch the window in front of lens
Care should be taken the cable is NOT to be damaged, kinked or exposed in the hazardous area. Do not expose the camera directly to a strong light source such as the sun or spot light.

Pan & Tilt adjustments

- Unlock the screw on the camera bracket through using the torque wrench supplied
- Set the camera's viewing angle then lock the screw on the bracket.

Adjustment of viewing angle with a bracket

1. Pan limit: Pan is limited to +/- 90°.

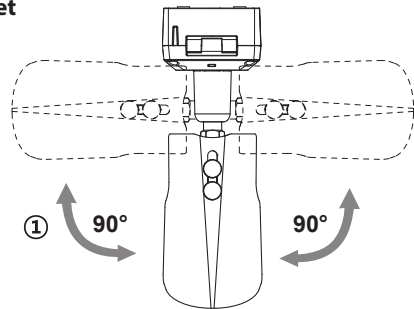

2. Tilt limit : Tilt is limited to 0°(2°) min ~ 90° max. for wall(ceiling) installation respectively with reference to the wall (ceiling) when the inclination of camera module is 0°, that is, the image is aligned horizontally.

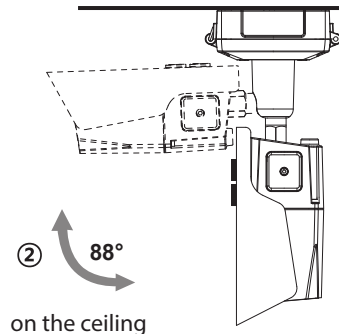
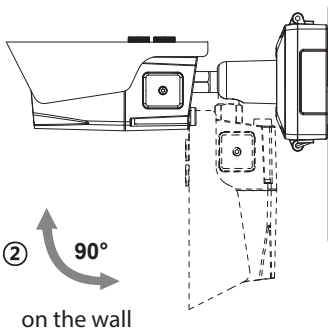

3. Inclination limit (Horizontal image alignment): Inclination limited to $\pm 90^\circ$ max.

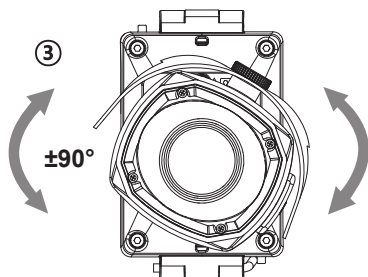

Adjustment of viewing angle with a bracket

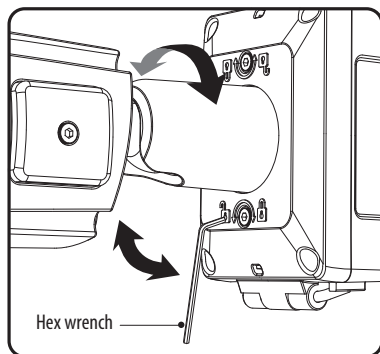

How to access with Wi-Fi generator

1. Plug Wi-Fi dongle with dongle connector in camera
2. Access the Wi-Fi configuration menu on Mobile or Tablet.

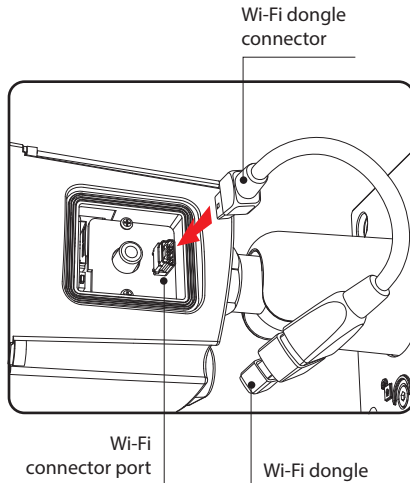

3. Search and connect the Wi-Fi, generated by camera. Password is **Mac address of camera** (case sensitive; written together; no punctuation). Please check the mac address label on the camera

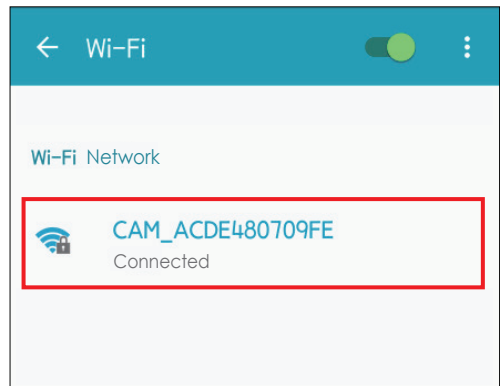

4. Open the web browser and access **192.168.125.1**

(Default IP address for Wi-Fi)

Loing in page will be open up and please enter default user name (admin) and password (admin).

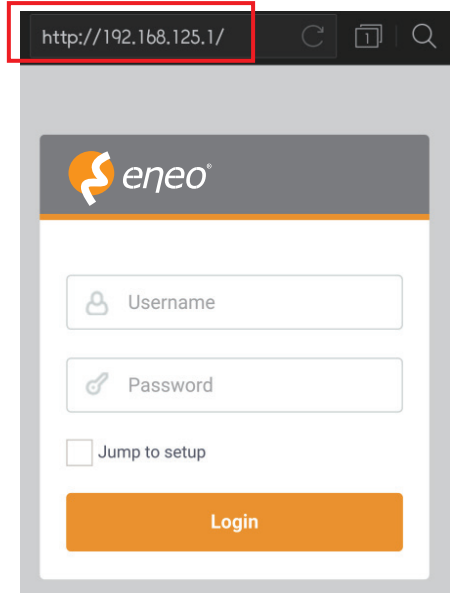

NOTICE

- Wi-Fi access is only for easy installation and service purpose.
Please be advised that camera cannot work through Wi-Fi.
- Wi-Fi dongle connector and Wi-Fi dongle are not included in this camera package.

General Description

- 3.23Mega Pixel, NETWORK CAMERA, 2048x1536(30p/25p)
- ONVIF Conformance, Zero configuration
- Cross Web Browsing (IE, Edge, Safari, Firefox, Chrome)
- Adaptive web resizing depending on layout & resolution of display device by RESPONSIVE WEB
 - Increased usability for all PC, tablet and mobile
- WiFi* generated by IPC for convenience setup
 - Zoom/Focus menu control by Smart phone or Tablet through WiFi
 - No need to carry BNC cable and service monitor
- Simultaneously H.264 & MJPEG (Triple streaming)
- 2 Way Audio & Alarm input/output
- ONVIF Event Mapping
- Slot for Micro SD memory card
- HTML5 playback
- f=2.7~12mm F1.4, Mega pixel Motorized zoom lens
- Dual Filter Switcher
- SNAP Focus by Motorized Zoom lens
- D-WDR (Digital Wide Dynamic Range)
- Improved noise figure with the enhanced 3DNR
- Motion Detection, Privacy Mask, Defog, BLC/HLC, D-Zoom(~16x), LDC(Lens Distortion Compensation), Hue, Brightness, Contrast, Saturation, Sharpness, Auto Flickerless, Tamper, VerticalView(90°/270°), VCA(Video Contents Analysis), IR LED control by WEB, Smart IR, Color DN
- Built-in 4pcs High power SMD LEDs
- Built-in Fan & Optimized Cooling System
- Dual Window, One touch 3-Axis locking bracket
- Circuit protection against faulty connection in power polarity
- Isolated power supply against ground loop problem
- PoE(IEEE Std. 802.3af) & AC24V/DC12V
- Integral and Handheld Junction Box
 - Both RJ-45 and Network wiring connector(LSA) are provided for flexible Network/PoE connection.
 - Junction Box cover opening(Sabotage) alarm can be triggered and integrated with various event actions.
 - Simple wiring and tidy cable arrangement.
 - A handheld Junction Box provides the easiest and most flexible installation
- IP67 Protection

* Wi-Fi access for installation/Service

Specification

ITEM	ICB-73M2712MWA
Imaging Sensor	1/2.8" Sony 3.23Mega pixel RGB Bayer Array CMOS Sensor
Effective Pixels	2048(H) x 1536(V) approx. 3.15Mega pixels
Sensitivity	Color Mode: 0.15 lux (LED off), B/W Mode: 0.03 lux (LED off)
Scanning mode	Progressive Scan
S/N Ratio	51dB
Day & Night mode	ICR by Auto, Day, Night, External, Color DN
WDR	Digital WDR (ATR-EX)
DNR	2D-NR, 3D-NR
Auto Exposure	Automatic (Priority: Frame rate/Low noise), Manual
Shutter Speed Control	Automatic: Min. 1/10,000 sec ~ Max. 30/25 sec Manual: Min. 1/10,000 sec ~ Max. 30/25 sec
Gain Control	Automatic: ~ Max. 46.2dB / Manual: ~ Max. 46.2dB
Auto White Balance mode	ATW-Indoor/Outdoor, Automatic, Shade, Clear sky, Fluorescent light, Light bulb, Flame, Manual
Lens	f= 2.7~12mm F1.4, Mega pixel Motorized Zoom lens
LEDs	Built-in 4pcs x 855nm High power LED
Functions	Privacy Mask, Motion Detection, VCA (Video Contents Analysis), Tamper, Defog, D-Zoom (~x16), HLC/BLC, LDC(Lens Distortion Compensation), Mirror/Flip, Hue, Brightness, Contrast, Saturation, Sharpness, Smart IR, Auto Flickerless, VerticalView, IR LED control by WEB
Installation Temp.	-20°C ~ +50°C (Humidity : 20%RH ~ 80%RH)
Operating Temp.	-50°C ~ +50°C (Humidity : 20%RH ~ 80%RH)
Dimension	108mm(W)x130.5mm(H)x318.4mm(L)_with Bracket / About 1.65kg
Housing	IP67, Aluminum Cast, One touch 3-Axis locking bracket, Dual Window, Fan & Optimized Cooling system
Power Source	PoE(IEEE Std. 802.3af), AC24V~14VA/DC12V=790mA, 9.5W Circuit protection against faulty connection in power polarity. Isolated power supply against ground loop problem.
NETWORK SPECIFICATION	
Video Compression	H.264(High, Main, Base line profile) MJPEG
Video Resolution	2048x1536, 1920x1440, 1920x1080, 1600x1200, 1280x960, 1280x720, 800x600, 640x480, 640x360, 320x240
Video Frame Rate	Up to 30/25fps@2048x1536p
Video Streaming	Simultaneously H.264 and MJPEG (Triple Streaming) Independent Frame Rate and Bandwidth Control, CVBR/CBR Mode
FTP Uploading	MJPEG Still Image

Specification

Login Authority	Administrator, Operator, Guest
Security	Multi User Authority, IP Filtering, HTTPS, Video Stream, Export/Import
Network Time Sync.	Synchronize Computer/NTP Server, Manual
Software Reset	Restart, Reset, Factory Default
Auto Recovery	Backup, Restore
Remote Upgrade	Using Web Browser
Protocol	TCP/IP, UDP, IPv4/v6, HTTP, HTTPS, FTP, UPnP, RTP, RTSP, RTCP, DHCP, ARP, Zeroconf, Bonjour
Client Software	Built-In Web, ONVIF Compatible 3rd Party VMS
SDK Support	API, ONVIF Profile S Compliant
SD memory card	Slot for Micro SD memory card
Audio & Alarm	2way Audio & Alarm input / output

(*) Design and specifications are subject to change for product improvements without prior notice.

Quick Network Setup

1. After the camera is connected to the network, start '**eneo Site Manager**' tool (downloadable from www.eneo-security.com).
2. You will get a list of cameras connected to the local network. Highlight your camera in the list and open a context menu with a click of the right mouse button.
3. Select the „Set IP Address [dhcp / static]“ option to open a window for setting the cameras IP properties. When you are done click the „OK“ button to update the camera settings.
4. By default the camera is set to DHCP. If there is no DHCP server present in the network the camera will fall back to a default IP address after a while. In this scenario please only add one camera at a time to the network to avoid conflicts due to identical IP addresses.
The network camera's default IP address is: **192.168.1.10**.
5. Right clicking the device name in the eneo Scan Device tool will bring up the context menu. Use the '**Open Device Web Site**' option to access the camera.
6. The web viewer login page will open up in your default web browser.
In case of Microsoft Internet Explorer install Active-X named VIDEOR E. Hartig GmbH according to the instruction at the bottom of the browser.
7. Use the default user name and password to log in.

Default user name: admin

Default password: admin

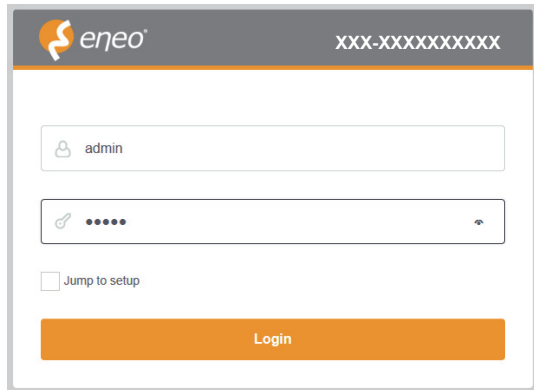

Further information

Make sure to always upgrade to the latest firmware version available from the eneo web site at www.eneo-security.com to receive the latest functionality for your product.

The manual, and other software tools are available on the eneo website at www.eneo-security.com or on the included CD.

Information on compatible video management software solutions can be found in the category **Videomanagement** at www.eneo-security.com.

Full Menu Setup

Web viewer description

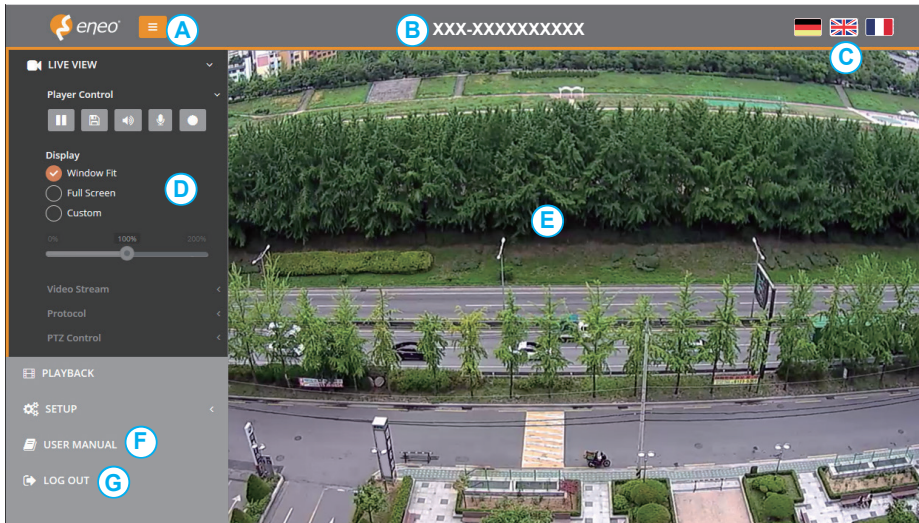

- (A) Menu button : Click the button to show or hide the setup menu bar.
- (B) Model name : Show a camera model name connected.
- (C) Select Language : Set the web viewer language English, Deutsch or French.
- (D) Main setup menu bar : Set the camera or network functions.
- (E) Camera monitoring window: Display the currently connected camera view or function.
- (F) User Manual : Help the menu function.
- (G) Log out and exit the web viewer

Full Menu Setup

Setup Menu Table

Category	Menu	Configuration			
LIVE VIEW	Player Control	Pause, Snapshot, Speaker, Microphone, Record			
		Display (Window Fit, Full Screen, Custom)			
	Video Stream	Stream1, Stream2, Stream3			
	Protocol	HTTP, TCP, UDP			
	PTZ Control	Zoom, Focus, Push AF			
PLAYBACK	Event Search, Timeline Search, Timeline Bar				
SETUP	Information	General, System Information, Open source Information			
	Video & Image	Source			
		Stream1/2/3, Snapshot			
		Image	Basic	Brightness, Contrast, Saturation, Hue, Sharpness, Enable flip image, Enable mirror image	
			OSD	Enable text OSD, Enable date&time OSD, Enable zoom&focus OSD, Mode	
			AE	Mode, Shutter, Max shutter, Gain, Max gain, Slow shutter, Auto iris, Auto flicker-less	
			AWB	Mode, Cb Gain, Cr Gain	
			AF	Mode, Speed, Lens Locking, Locking Timer, Lens Calibration, Enable Day&Night sync focus	
			Day&Night	Mode, Switching time, Threshold(D->N), Threshold(N->D), IR LED control, Smart IR	
			WDR	WDR(Mode, Level), Defog(Mode)	
			BLC	BLC(Mode, Level), HLC(Mode)	
			DNR	2DNR(Mode, Level), 3DNR(Mode, Level)	
			LDC	Mode, Level, Boundary Line	
		VerticalView	Mode, Rotation		
	Privacy Mask	Color, Name			
	Digital Zoom	Level			
	Audio	Compression, Sample rate, Bitrate, Input Volume, Output Volume, Audio auto activation on ONVIF access			
Record	Record	Overwrite when storage is full, Continuous record setting			
	Schedule				
	Storage	Format, Remove, Storage Information			
Event	Triggers	Motion, VCA, Tamper, Alarm In, System, Manual, Network, Timer, Day/Night			

Full Menu Setup

SETUP	Event	Actions	Record, Alarm Out, E-Mail, FTP, Video Boost, Notification Server
		Rules	Event Processing, ONVIF Mapping
	System	Security	User, HTTPS, IP Filter, ONVIF, Video Stream, Export/Import
		Date & Time	Current Time, New Time, Time Zone, Date&Time Display
		Network	TCP/IP, DDNS, RTP, UPnP, Zeroconf, Bonjour, WiFi
		Language	English, Deutsch, Français, Polski, Suomi, 한국어
		Maintenance	Maintain (Restart, Reset, Default), Upgrade, Setup Export, Setup Import
		Logs & Report	Logs (Database Capacity, Search Condition, Log List), Report
USER MANUAL			
LOG OUT			

Full Menu Setup

1. LIVE VIEW

Enter the live view menu on the Web Viewer.

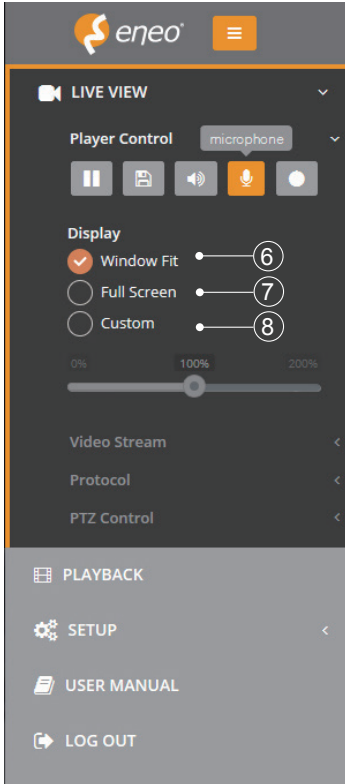

■ Player Control & Display



- ① Pause : Pauses the live view.
- ② Snapshot : Captures the image in .jpg format with the current stream resolution.
- ③ Speaker : Enables Audio to be output to the audio out port.
- ④ Microphone : Enables Audio to be input from the audio input port.
- ⑤ Record : Records the live video in H.264 format into the equipped storage memory like SD, SDHC & SDXC with the selected video stream at the RECORD menu.

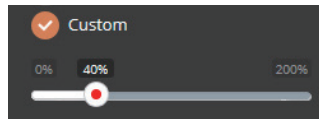

- ⑥ Window Fit : Resizes the live view display to fit along with the display window size.
- ⑦ Full Screen: Resizes the live view display to fit to the monitor resolution. ESC key returns to the previous view.
- ⑧ Custom : Selects the live view display scale, 0%~200%, by the control bar. 100% is original size.

■ Video Stream

Selects the video source stream to display the live view only.

■ Protocol

Selects the network protocol out of HTTP, TCP or UDP.

Full Menu Setup

■ PTZ Control

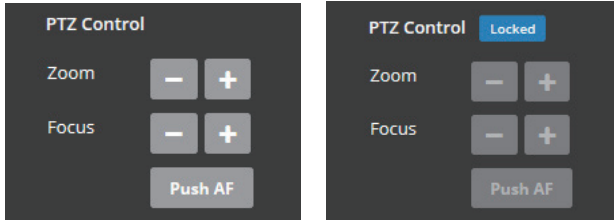

- ZOOM : Controls the lens optical zoom in/out for WIDE & TELE.
- FOCUS : Adjusts the lens focus manually for NEAR & FAR.
- PUSH AF : Gets the lens to focus at the push of a button.

NOTE

ZOOM, FOCUS & PUSH AF are disabled when PTZ control is locked.

PTZ control can be unlocked at Setup>Video&Image>Image>AF>Lens Locking to OFF or TIMER.

CAUTION

- Set LENS LOCKING at Setup>Video&Image>Image>AF>Lens Locking to ON or TIMER after completing lens setting to prevent unwanted lens operation.
- Do not adjust zoom/focus in low light conditions or night mode. It might cause erroneous focusing.
- For V/F versions, Zoom/Focus operation is strongly recommended for installation purpose only. Frequent zoom/focus adjustments can reduce the life span of the lens.

Full Menu Setup

2. PLAYBACK

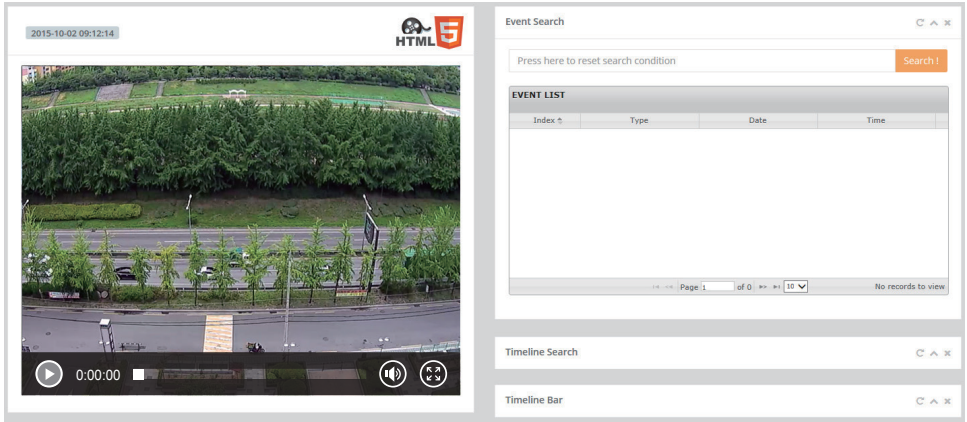

■ Event Search

Playback display using the event list.

- Press the input bar to pop up EVENT DATE & TIME window and select the event TYPE.
- Click SEARCH button to show up EVENT LIST.
- Select the recorded event and click the play button at the bottom-left corner of the playback window.

■ Timeline Search

Playback display by Date & Time for continuous and event recording.

- Select the date in the SEARCH CALENDAR and then the hour & minute at TIMELINE BAR.

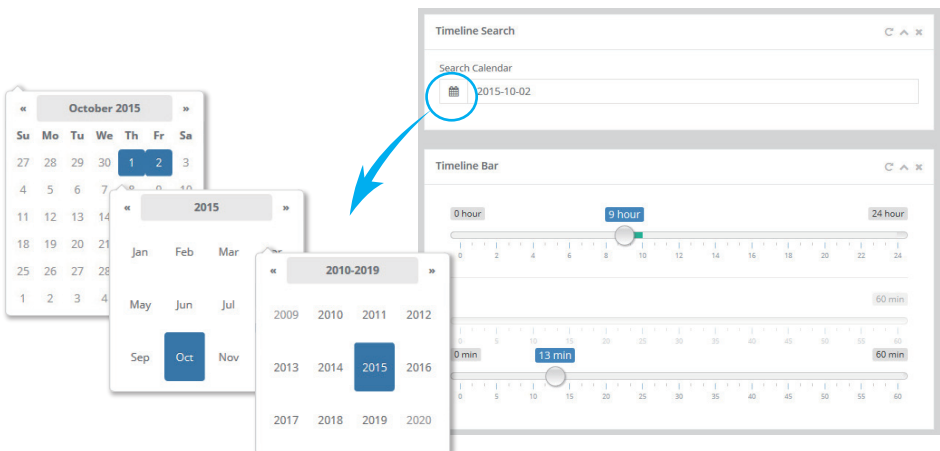

Full Menu Setup

3. SETUP

Enter the setup menu on the Web Viewer.

3-1. Information

Shows the overall information about the system such as Model name, MAC address, IP address, Zeroconf, IP address, Firmware version, Server time, Running time, CPU usage, Inbound/Outbound Bandwidth and Open source list.

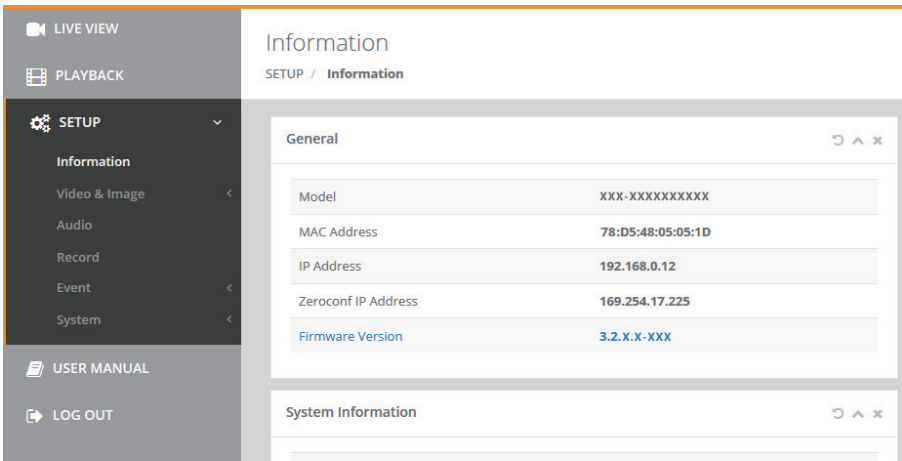

General	
Model	XXX-XXXXXXXXXX
MAC Address	78:D5:48:05:05:1D
IP Address	192.168.0.12
Zeroconf IP Address	169.254.17.225
Firmware Version	3.2.X.X-XXX

3-2. Video & Image

3-2-1. Source

- **SIGNAL** : Set NTSC/PAL mode depending on TV system. Generally set to NTSC in 60Hz area and PAL in 50Hz area for the electrical power system of your country. Changes will restart the camera.

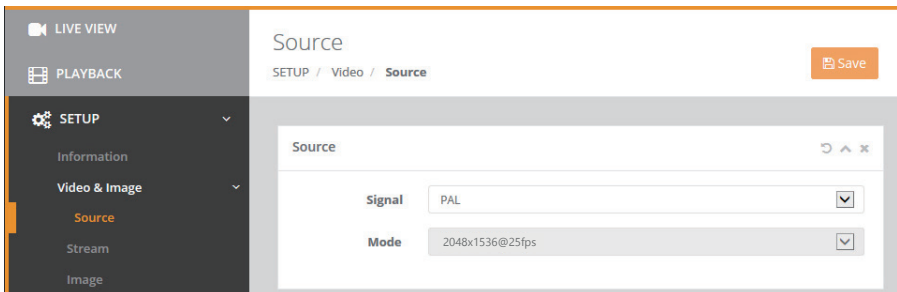

Source	
Signal	PAL
Mode	2048x1536@25fps

Full Menu Setup

3-2-2. Stream

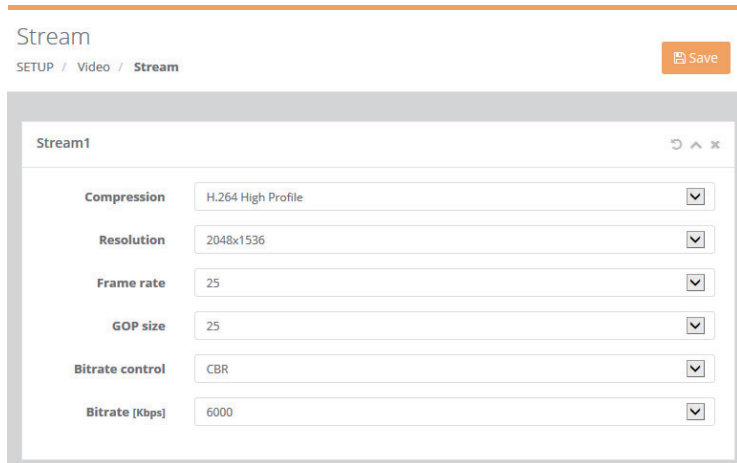

• **Stream1, 2, 3**

- > **COMPRESSION** : Video compression codecs are available with H.264 profiles for all streams and additional MJPEG for stream3 only.
- > **RESOLUTION** : Each stream can have its individual resolution selected from its list.
- > **FRAME RATE** : Each stream can have its individual frame rate in fps selected from its list.
- > **GOP SIZE**: GOP (Group of Picture) defines the number of Intra-coded pictures (I frame) & Predictive-coded pictures(P frame) in H.264. I frame is a complete image while P frame is the predictive image data which can lower the image data dramatically between frames. GOP SIZE stands for the number of P frames between I frames. Too small GOP SIZE (too frequent I frames) can degrade the picture quality because the codec compresses the data strongly to maintain the bitrate. On the contrary, a little bigger GOP SIZE can improve the picture quality with the better quality for P frames if the network is in good condition. Too big GOP SIZE can make the longer black out or the broken image if the network quality is not good enough.
- > **BITRATE CONTROL** : Selects how to manage the bitrate.
 - **CVBR (Constrained Variable Bit Rate)**:
Provides the higher image quality with the optimal variable bitrate for the scene which has more moving elements in the image. It is not recommended when network is in heavy duty.
 - **CBR (Constant Bitrate)** :
Tends to keep the bitrate steady at the assigned bitrate within a very small variation. It is useful when the network is in very heavy use.

Full Menu Setup

> **BITRATE** : Indicates the transmission speed through the network and defines the overall picture quality along with the image resolution, frame rate, GOP size and the compression codec for H.264. A high value provides the higher image quality but the total sum of bitrates for the streams has to be considered in calculating the network duty.

• Snapshot

Capture the video from the camera and create JPEG image files to acquire the image information such as number recognition software.

> Type http://ip_address/cgi-bin/snapshot.jpg in the address bar and press ENTER.

> Check the setting for capture image resolution:

WEB Viewer → Log in → Main Menu → Setting → Video&Image → Video Stream → Stream3 → Compression: MJPEG (Resolution: 1280x720),
Snapshot → Source : Stream3

※ To maximize the resolution of the captured image, set the Snapshot → Source to 'Stream1'.

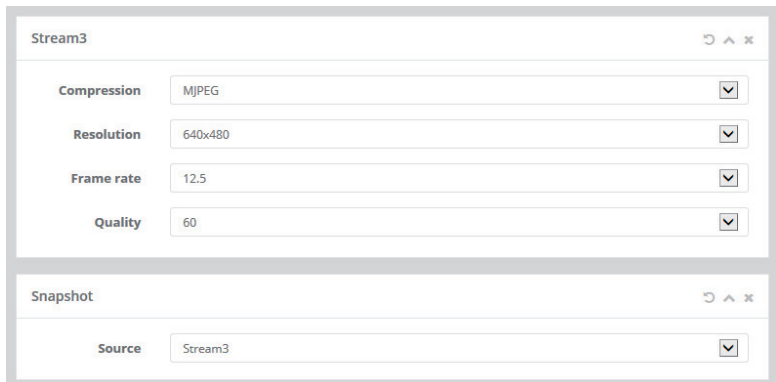

※ If the error message '401 Unauthorized' pops-up:

WEB Viewer → Log in → Main Menu → Setting → System → Security → Video Stream to disable the check boxes.

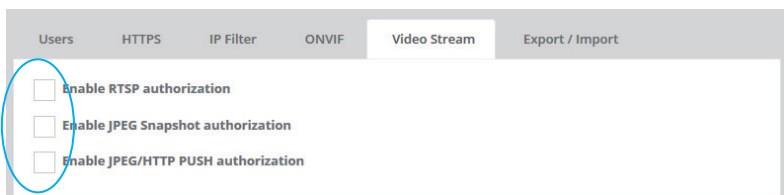

Full Menu Setup

3-2-3. Image

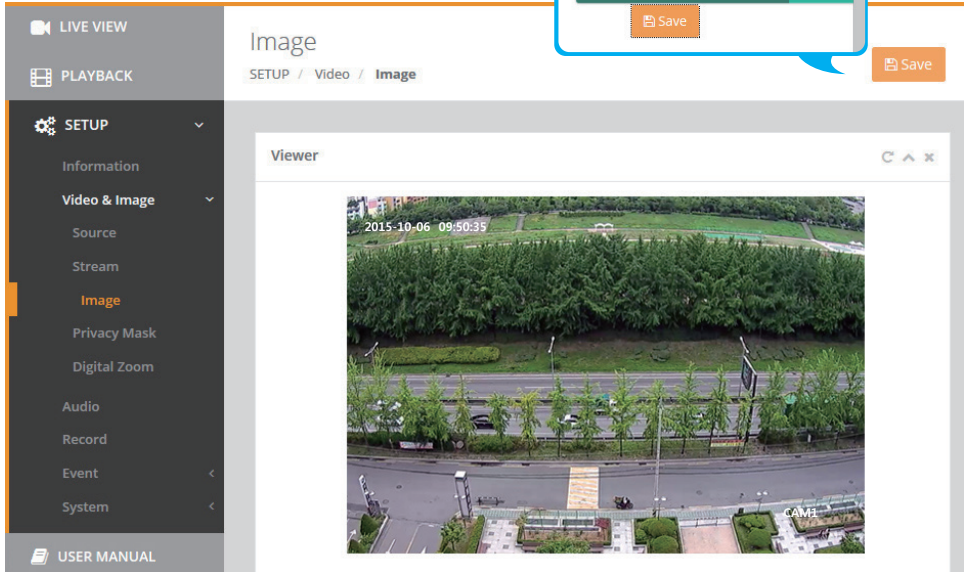
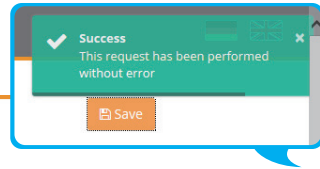

• Basic

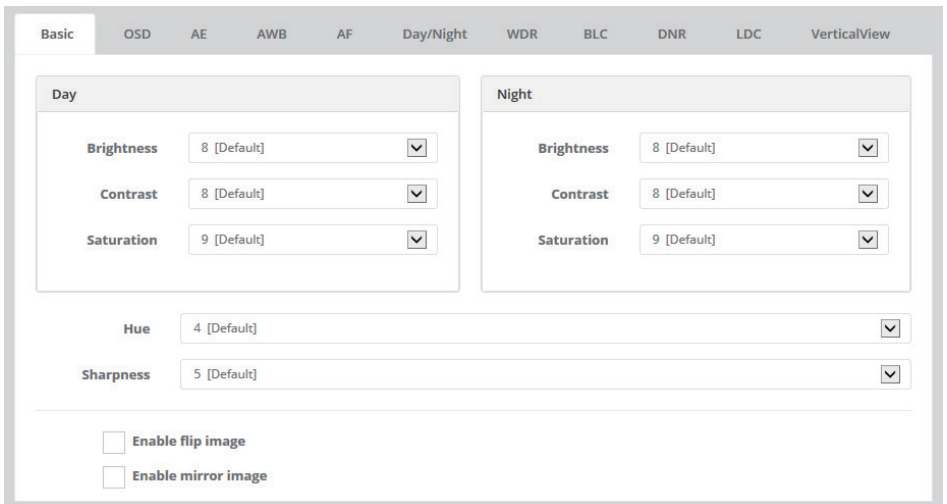

Full Menu Setup

- > BRIGHTNESS: Adjusts the overall brightness of the scene. Increasing the value increases the brightness.
- > CONTRAST: Adjusts the contrast of the scene. Increasing the value increases the contrast.
- > SATURATION: Adjusts the color richness of the scene. Increasing the value increases the color richness.
- > HUE: Adjusts the color hue (NTSC only). Decreasing the value produces a greenish hue and increasing the value produces a pinkish hue.
- > SHARPNESS: Adjusts the sharpness of the scene. Increasing the value increases the sharpness.
- > ENABLE FLIP IMAGE : Flips the image on horizontal axis (up and down).
- > EABLE MIRROR IMAGE : Mirrors the image on vertical axis (left and right).

• OSD

- > ENABLE TEXT OSD : Enables display of the Text typed in the TEXT field (displays bottom-right).
- > ENABLE DATE&TIME OSD : Enables display of the Date & Time (displays top-left).
- > ENABLE ZOOM&FOCUS OSD : Enables display of the Zoom Ratio & Focusing Mode. (displays top-right). (Applies to Built-in Motor driven V/F lens and AF models only)
- > MODE : Allows you to select when the ZOOM&FOCUS OSD is displayed.
 - ON PUSH: Displays on the OSD for a few seconds whilst lens is adjusting.
 - ALWAYS: Displays on the OSD at all times.

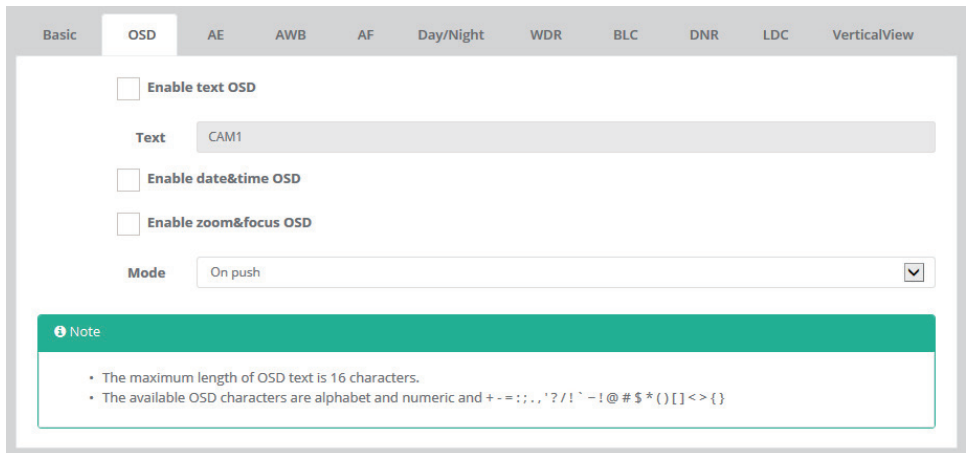

Full Menu Setup

• AE

- > MODE : Selects how to control the exposure, AUTOMATIC or MANUAL.
- > SHUTTER : (Available only in MANUAL mode) Sets the shutter to a fixed value.
- > MAX. SHUTTER : Sets the maximum exposure time to limit long exposure at night or in low-light scenes.
- > GAIN : (Available only in MANUAL mode) Sets the overall video gain.
- > MAX. GAIN : Sets the maximum gain that can be automatically reached at night or in low-light scenes.
- > SLOW SHUTTER : Extends the shutter time over the maximum shutter at multiple times of value in SLOW SHUTTER. Increasing the values increases brightness but also increases blurriness.
- > AUTO IRIS : Engages the mechanical iris of lens to control the amount of incoming light to the sensor.
 - OFF : Iris opens and the shutter is engaged to control the video level.
 - OUTDOOR : Optimized for the bright scene with the limited shutter speed range.
 - INDOOR : Suitable for Indoor use with the fixed shutter speed.
- > AUTO FLICKERLESS : Automatically detects and fixes the flickering image under fluorescent lighting caused by the mismatch between NTSC/PAL and 50Hz/60Hz electric power frequency.

Basic	OSD	AE	AWB	AF	Day/Night	WDR	BLC	DNR	LDC	VerticalView
		Mode	Automatic							
		Shutter [sec]	1/1000 [Default]							
		Max. Shutter [sec]	1/25 [Default]							
		Gain [dB]	10.0 [Default]							
		Max. Gain [dB]	36.0 [Default]							
		Slow Shutter	Off							
		Auto Iris	Off							
		Auto Flicker-less	Off							

• AWB

- > MODE : Provides White Balance presets. ATW-INDOOR or ATW-OUTDOOR is recommended for most applications.
- > Cb GAIN / Cr GAIN : (Available only in MANUAL AWB mode)
Adjusts the white balance by Cb/Cr color components to the specific lighting which has a fixed color temperature. Not recommended for regular scenes.

Full Menu Setup

Basic	OSD	AE	AWB	AF	Day/Night	WDR	BLC	DNR	LDC	VerticalView	
			Mode	ATW - Indoor							▼
			Cb Gain	20							▼
			Cr Gain	20							▼

• AF

- > MODE : Selects how to control the focus of the built-in Motor driven V/F lens or AF lens.
 - MANUAL : Focusing works during zoom operation only and stops thereafter.
 - AUTOMATIC : Focusing works steadily for sharp focusing on the object. In the case of a Motor driven lens, focusing resumes in about 7~8 seconds to save the lens lifetime when the focus gets lost.

[NOTE]

- 1) MANUAL mode is strongly recommended to maintain the working-life of the lens.
 - 2) Lens operation count is stored in the camera for service purposes.
- > SPEED : Adjusts the zoom control speed. Increasing the value increases the speed.
 - > LENS LOCKING : Allows locking of the lens control to prevent undesirable operation.
 - OFF : Disables the locking feature allowing lens operation at any time.
 - ON : Locks and disables the lens operation immediately.
 - TIMER : Locks and disables the lens operation after a certain period of time, as set in LOCKING TIMER.
 - > LOCKING TIMER : Defines the amount of time before the lens is locked.
 - > LENS CALIBRATION : Calibrates and renews the lens data as setup at the Factory.

Basic	OSD	AE	AWB	AF	Day/Night	WDR	BLC	DNR	LDC	VerticalView	
			Mode	Manual							▼
			Speed	3							▼
			Lens Locking	Timer							▼
			Locking Timer [hour]	24		▼	Locked		Reset		
			Lens Calibration	Start							
<input type="checkbox"/> Enable Day & Night sync focus											

Full Menu Setup

[WARNING]

LENS CALIBRATION is not necessary for regular installations.

LENS CALIBRATION would only be necessary should you not be able to focus the lens after a zoom operation due to shock during transportation of the camera.

To perform LENS CALIBRATION:

- A fixed object with sharp edges should be at least 3 meters away in front of the camera and should be stationary i.e. not moving. A plain wall is not suitable to calibrate on.
 - The camera must be placed firmly, without shock or vibration, during the calibration.
 - Scene light level must be bright enough. Do not try calibration at night or in low-light.
 - If the calibration fails, change the environment and try again.
- > ENABLE DAY&NIGHT SYNCFOCUS : Enables refocusing whenever the day&night changes. It is not recommended to use this feature as it may lose focus over the night due to focusing failure at night.

• Day & Night

- > MODE : Selects how to control the day/night feature.
- DAY : Disables the switching day/night filter and fixes it to DAY only.
 - NIGHT : Disables the switching day/night filter and fixes it to NIGHT only.
 - AUTOMATIC : Allows the day/night filter to switch via the amount of the incoming light through the lens only. Cameras without the built-in IR LED must select AUTOMATIC.
 - EXTERNAL : Allows the day/night filter to switch via the built-in light sensor only, like a photo sensor. Cameras with the built-in IR LED must select EXTERNAL.
 - COLOR DN [AUTOMATIC] : Produces the color video at night without switching day/night filter. Values in BRIGHTNESS, CONTRAST&SATURATION at SETUP>VIDEO&IMAGE>IMAGE>BASIC>DAY or NIGHT are applied to the scenes for day and night accordingly.
- > SWITCHING TIME : Delays switching the day/night filter to prevent from an undesirable transition.
- > THRESHOLD [D->N] : (Available in AUTOMATIC mode)
Sets the threshold level for day->night switching. Decrease the value to switch at low luminance.
- > THRESHOLD [N->D] : (Available in AUTOMATIC mode)
Sets the threshold level for night->day switching. Increase the value to switch at high luminance.

[CAUTION]

- The gap between THRESHOLD [D->N] and THRESHOLD [N->D] should be greater than 18. Otherwise, an undesirable transition may occur.
- Too high a value in THRESHOLD [N->D] can cause cameras at installed in low-light areas to stay in night mode permanently i.e. even during daytime.

Full Menu Setup

Basic	OSD	AE	AWB	AF	Day/Night	WDR	BLC	DNR	LDC	VerticalView
					Mode External					
					Switching Time [sec] 1 [Default]					
					Threshold [Day->Night] 46 [Default]					
					Threshold [Night->Day] 67 [Default]					
					IR LED Control Automatic					
					Smart IR Off					
Note • The "Threshold [Night->Day]" value must be greater than the value of "Threshold [Day->Night]" enough to prohibit hunting										

- > IR LED Control : (Available in EXTERNAL modes)
 - AUTOMATIC : LEDs turn ON or OFF by the built-in light sensor.
 - OFF : LEDs turn OFF and fixes it regardless of lighting conditions.
- > SMART IR : (Available in NIGHT and EXTERNAL modes)

Helps reduce the highlight saturation at the center of the image caused by strong IR LED illumination. Corners may appear darker instead.

Full Menu Setup

• **WDR**

> WDR (Wide Dynamic Range) :

- **MODE** : ON enhances the dynamic range by the extended adaptive tone reproduction.
- **LEVEL** : Determines the strength of the dynamic range. Higher values increase brightness.

> **DEFOG** : Enhances the image contrast automatically against fog.

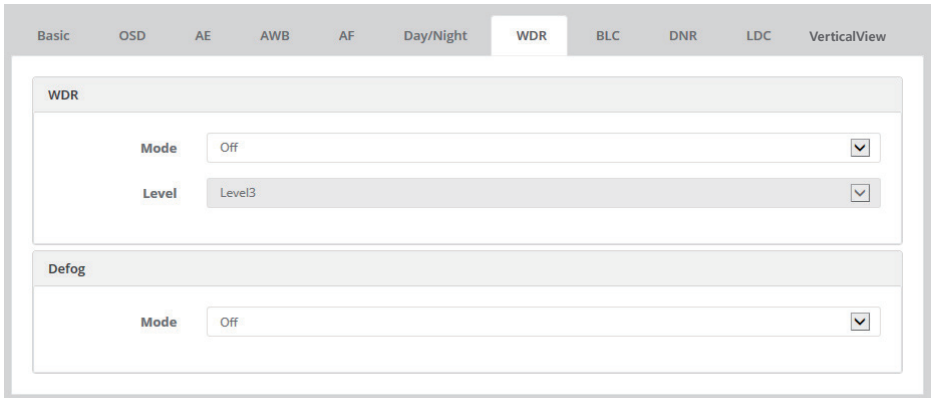

The screenshot shows the camera's OSD menu with the 'WDR' tab selected. The 'WDR' section has two settings: 'Mode' set to 'Off' and 'Level' set to 'Level3'. Below it, the 'Defog' section has 'Mode' set to 'Off'.

• **BLC**

> BLC (Back Light Compensation) :

- **MODE** : ON enhances the visibility of the back-lit object.
- **LEVEL** : Determines the strength of the bright-up. High value gets brighter.

> **HLC** (High Light Compensation) :

ON cuts out the highlight area with black mask and excludes it from compensation.

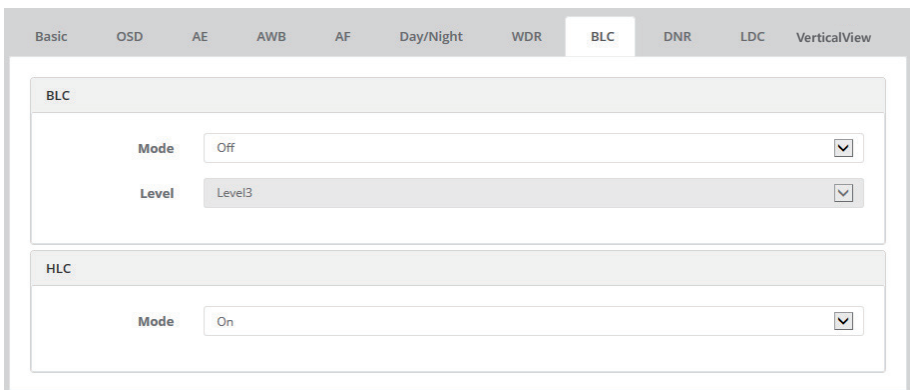

The screenshot shows the camera's OSD menu with the 'BLC' tab selected. The 'BLC' section has two settings: 'Mode' set to 'Off' and 'Level' set to 'Level3'. Below it, the 'HLC' section has 'Mode' set to 'On'.

Full Menu Setup

- **DNR** (Dynamic Digital Noise Reduction)

> 2DNR :

- **MODE**: ON reduces the noise by suppressing the spatial noise components.
- **LEVEL**: Determines the strength of the noise reduction. Higher values reduce more noise but can also lead to loss of detail.

> 3DNR :

- **MODE**: ON reduces the noise by cancelling the spatial & temporal components in 3 dimensional a way.
- **LEVEL**: Determines the strength of the noise reduction. Higher values reduce more noise but can also lead to a ghosting effect.

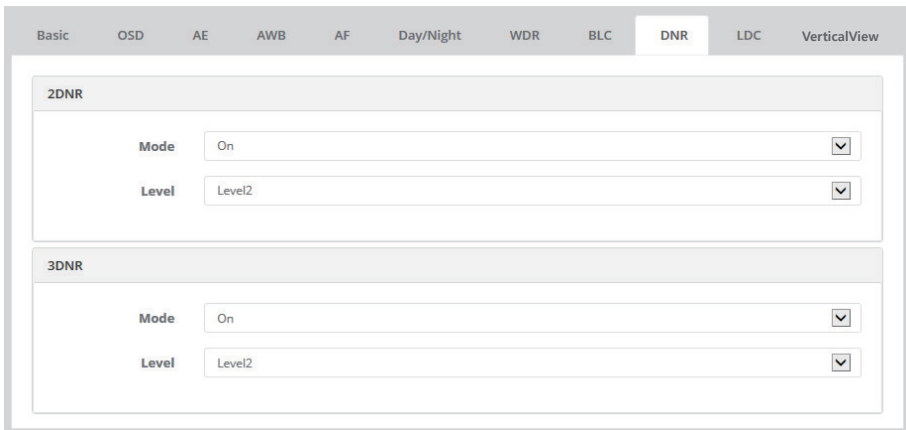

The screenshot shows the camera's menu interface with the 'DNR' tab selected. It displays two sections: '2DNR' and '3DNR'. Each section has a 'Mode' dropdown menu set to 'On' and a 'Level' dropdown menu set to 'Level2'.

- **LDC** (Lens Distortion Compensation)

- > **MODE** : ON compensates for the barrel distortion caused by wide angles.
- > **LEVEL** : Determines the amount of the compensation. Higher values expand the shrunken areas in the corners.
- > **BOUNDARY LINE** : (Available in LDC MODE = OFF)
ON displays left and right boundary lines to show how much distortion occurs.

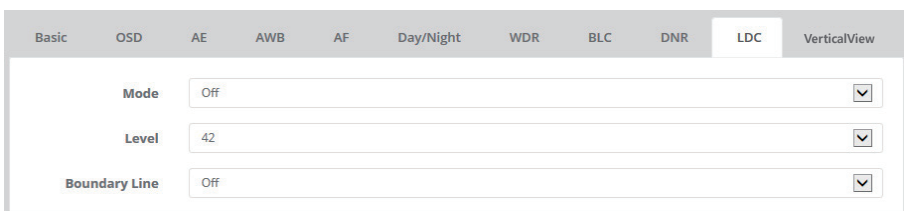

The screenshot shows the camera's menu interface with the 'LDC' tab selected. It displays three settings: 'Mode' set to 'Off', 'Level' set to '42', and 'Boundary Line' set to 'Off'.

Full Menu Setup

• VerticalView

- > MODE : ON displays the video in vertical view format, 16:9->9:16 for narrow streets, corridors or hallways.
- > ROTATION : Determines the orientation to rotate.

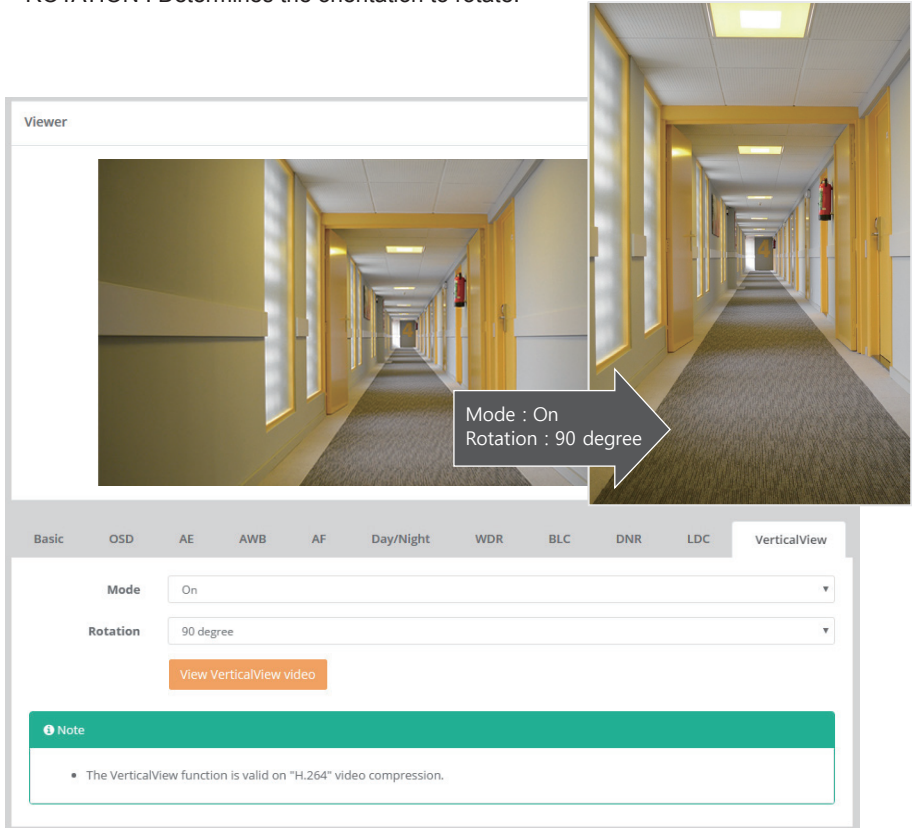

Viewer

Mode : On
Rotation : 90 degree

Basic OSD AE AWB AF Day/Night WDR BLC DNR LDC VerticalView

Mode On

Rotation 90 degree

View VerticalView video

Note

- The VerticalView function is valid on "H.264" video compression.

Full Menu Setup

3-2-4. Privacy Mask

Mark ENABLE checkbox to activate the privacy masks.

> COLOR : Select the color to mask at each privacy area.

> NAME : Input the individual name for each privacy mask.

Privacy Mask
⌵ ⌵ ⌵



Enable

Color ⌵

Name

ID	Name	Delete
1	New	<input type="button" value="Delete"/>

Note

• The position of mask can be changed only if digital zoom and corridor function are inactive

To set the privacy mask (up to 8 privacy areas) :

- 1) Mark ENABLE checkbox.
- 2) In the video window, place the mouse cursor anywhere and click the right mouse button. A mini pop up appears.
Select CREATE MASK AREA / DELETE MASK AREA.
- 3) In the video window, place the mouse cursor where you would like to create a mask.
Click the left-mouse button to create (or delete) a mask. The mask window can be moved or resized with the mouse.
- 4) Enter the name in the list and then click SAVE.

Full Menu Setup

3-2-5. Digital Zoom

- > Mark ENABLE checkbox to activate the digital zoom.
- > LEVEL selects the fixed digital zoom ratio. X1.0 is not digital zoomed.

3-3. Audio

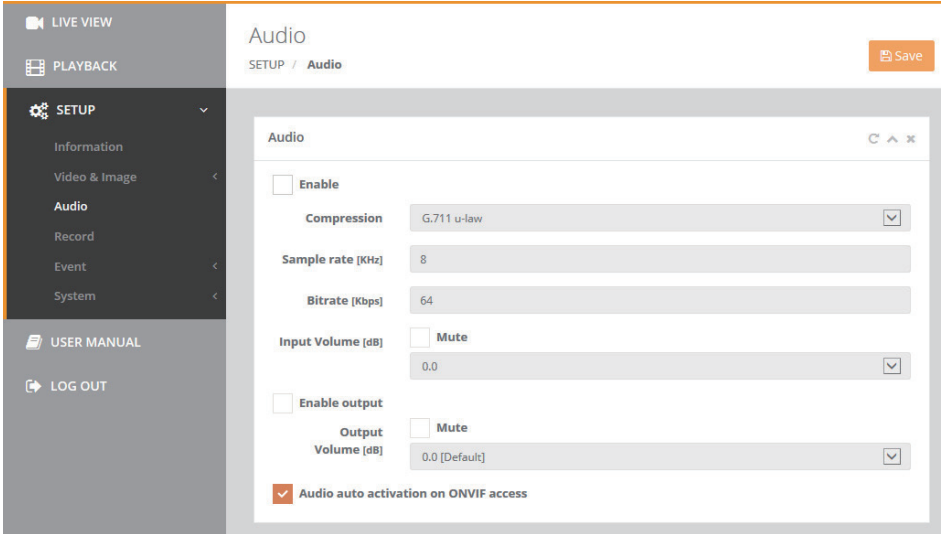

- > Mark ENABLE checkbox to activate the audio. Supports full duplex audio.
- > COMPRESSION : Selects audio compression codec. μ -law is used primarily in North America and a-law used in most other countries outside North America. G.711 μ -law tends to give more resolution to higher range signals while G.711 a-law provides more quantization levels at lower signal levels.
- > SAMPLE RATE : Fixed at 8KHz by G.711.
- > BITRATE : Fixed at 64Kbps by G.711, the international standard for encoding wired-telephone audio.
- > Mark INPUT MUTE checkbox to mute the input from audio-in.
- > INPUT VOLUME : Adjusts the volume by the input signal level. -0.5dB reduces the volume about -6%, 0.0dB bypasses the signal without adjusting the volume and 3.0dB increases the volume about +41%.
- > Mark ENABLE OUTPUT checkbox to activate the audio. Supports full duplex audio.
- > Mark OUTPUT MUTE checkbox to mute the output to audio-out.
- > OUTPUT VOLUME : Adjusts the volume by the output signal level. -0.5dB reduces the volume about -6%, 0.0dB bypasses the signal without adjusting the volume and 3.0dB increases the volume about +41%.
- > Mark ENABLE the checkbox to make Audio auto activation after reset or rebooting the camera to be compatible to ONVIF.

Full Menu Setup

3-4. Record

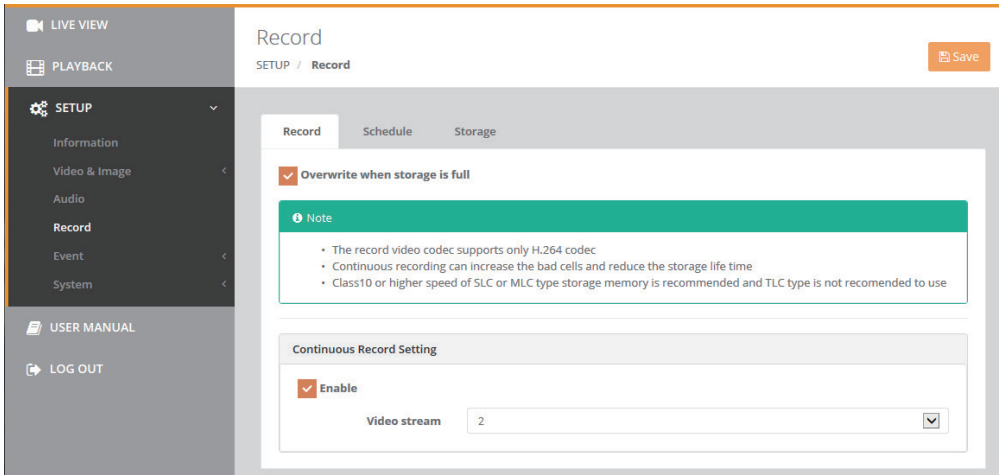

3-4-1. Record

- > Mark OVERWRITE WHEN STORAGE IS FULL checkbox to allow the storage to be overwritten.
- > CONTINUOUS RECORD SETTING : Mark ENABLE checkbox to activate the continuous recording into the storage.
- > VIDEO STREAM : Selects the stream to be recorded into the storage.

[NOTE] SD, SDHC or SDXC memory can be used as a storage device. Refer to manual for the suitable memory size from standard SD or micro SD.

3-4-2. Schedule

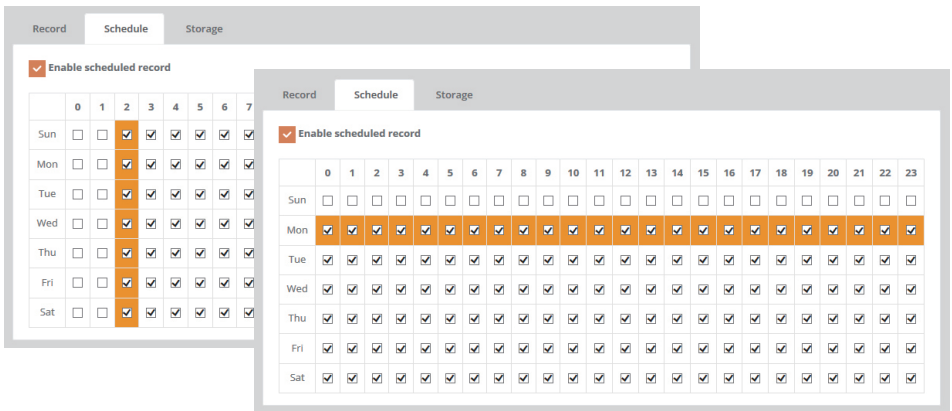

Full Menu Setup

- > Mark ENABLE SCHEDULED RECORD checkbox to activate the scheduled recording into the storage.
- > Mark each box in time and day matrix when to be recorded.
It can be selected a time zone or day of the week.

3-4-3. Storage

- > **FORMAT** : Formats the storage. Backup the data before formatting the storage if necessary.
- > **REMOVE** : Helps removing the storage safely.

[NOTE]

Common Internet File System (CIFS) is a remote file access protocol that forms the basis for Windows file sharing, network printing, and various other network services. CIFS requires a large number of request/response transactions and its performance degrades significantly over high-latency WAN links such as the Internet. Network File System (NFS) is a network file system protocol, allowing a user on a client computer to access files over a network in a manner similar to how local storage is accessed. NFS, like many other protocols, builds on the Open Network Computing Remote Procedure Call (ONC RPC) system.

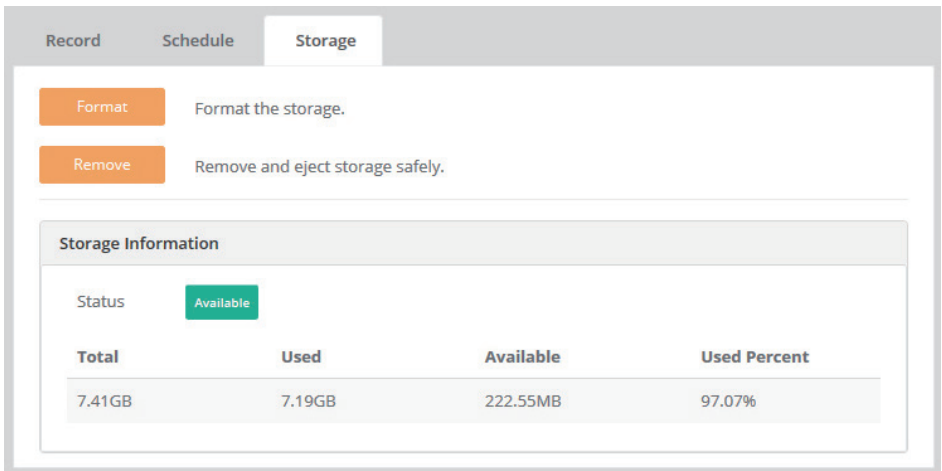

The screenshot shows a software interface with three tabs: 'Record', 'Schedule', and 'Storage'. The 'Storage' tab is active. Below the tabs, there are two orange buttons: 'Format' and 'Remove'. The 'Format' button is accompanied by the text 'Format the storage.' and the 'Remove' button is accompanied by 'Remove and eject storage safely.' Below these buttons is a section titled 'Storage Information' which contains a table with storage details.

Total	Used	Available	Used Percent
7.41GB	7.19GB	222.55MB	97.07%

Full Menu Setup

3-5. Event

3-5-1. Triggers

EVENT TRIGGERS menu defines and sets the parameters for the various event sources.

[Important NOTE]

Once the event is generated, the camera can record the video into the storage, output the alarm signal, email the event, send the video clip to FTP, boost the video frame rate, move to PTZ preset or send the event to the notification server. These post processes require the settings at SETUP>EVENT>ACTIONS first and then SETUP>EVENT>RULES.

● Motion

- > Mark ENABLE checkbox to create & activate up to 4 motion areas.
- > NAME : Input the individual name for each motion detection area.
- > SENSITIVITY: Sets the motion detection sensitivity for all areas. Higher values increase sensitivity
- > DWELL : Sets the time for the motion event once detected.

LIVE VIEW

PLAYBACK

SETUP

- Information
- Video & Image
- Audio
- Record
- Event
 - Triggers**
 - Actions
 - Rules
 - System

USER MANUAL

LOG OUT

Triggers

SETUP / Event / Triggers Save

Motion
VCA
Tamper
Alarm In
System
Manual
Network
Timer
Day/Night

Enable

Name:

Sensitivity: ▼

Dwell [sec]: ▼

ID	Name	Type	Dwell	Delete
1	default	Include	3	<input type="button" value="Delete"/>

Full Menu Setup

To set the motion detection area (up to 4 include-types and 4 exclude-types) :

- 1) Mark ENABLE checkbox.
- 2) In the video window, place the mouse cursor where you would like to make a detection window and click&drag the right button. The following window is then generated.
 - INCLUDE-Type : defines areas where motion should be detected.
 - EXCLUDE-Type : defines areas within a window that should be ignored.
- 3) Enter a name and then click SAVE.

[NOTE]

Motion detection and VCA cannot be used simultaneously. If either one is enabled, the other one is disabled automatically.

● **VCA** (Video Contents Analysis)

- > Mark ENABLE checkbox to create & activate up to 3 VCAs(Line Cross & Field Intrusion).
- > NAME : Input the individual name for each VCA.
- > DIRECTION : (Line Cross only) Sets the direction of detection for the line cross.
 - TWO WAY : Detects the line cross in either way.
 - CW : Detects the line cross when crossed the line in the direction of arrow.
 - CCW : Detects the line cross when crossed the line in the direction of arrow.
- > COUNT : (Line Cross only) Displays the number of the object detections by the line cross detector.
- > RESET : Resets the count number.
- > DWELL : Sets the time for the event once detected.

To set the VCA detection area (up to total 3 VCAs including Line Cross & Field Intrusion) :

- 1) Mark ENABLE checkbox.
- 2) Click the mouse right button on the video viewer and a popup menu appears.
 - CREATE VCA DETECTOR : Select to create the VCA type, up to 3 VCAs.
 - LINE CROSS : Detects an object crossing the virtual line for the line cross detection.
 - FIELD INTRUSION : Detects objects entering or leaving the defined virtual window.
 - CREATE MASKING AREA : Select to create the masking area which will exclude the detection.
 - DELETE VCA DETECTOR : Deletes the existing VCA window. VCAs can be deleted at the list too.
 - DELETE MASKING AREA : Deletes the existing VCA mask window.
- 3) Enter a name and then click SAVE.

[NOTE]

Motion detection and VCA cannot be used simultaneously. If either one is enabled, the other one is disabled automatically.

Full Menu Setup

Triggers

SETUP / Event / Triggers

Save

Motion
VCA
Tamper
Alarm In
System
Manual
Network
Timer
Day/Night

OBJECT SETTING

Sensitivity :
1
80
100

Width :
1
26
100

Height :
1
28
100

Show object size

- Min. object size : 10 x 5 [px]

- Max. object size : 250 x 151 [px]

Enable

Name

Dwell time [sec] ▼

Direction ▼

Count

ID	Name	Detector	Direction	Count	Dwell	Delete
1	New1	Line cross	CW	28	3	<input type="button" value="Delete"/>

> **OBJECT SETTING:**

Click the green rotating icon on the top-right of the video window and OBJECT SETTING menu will appear. To hide it, click the icon again.

Mark SHOW OBJECT SIZE checkbox and a black rectangle at the top-left corner of the video window will appear. The black rectangle is the reference size which shows the minimum (white box) & maximum (black box) detecting size of the object. To adjust the minimum (or maximum) object size to be detected, adjust the left (right) ends of the slide bars, WIDTH & HEIGHT, by moving them with clicking and holding the left mouse button. Objects can be detected only for the object size set between minimum and maximum, that is, an object which is smaller than minimum or greater than maximum can't be detected. Too small value in MINIMUM or too big value in MAXIMUM for the object size might increase the erroneous detections.

Full Menu Setup

- **SENSITIVITY** : Sets the detection sensitivity for the objects.
- **WIDTH** : Sets the minimum/maximum sizes in width of the objects to be detected.
- **HEIGHT** : Sets the minimum/maximum size in height of the objects to be detected.
- **SHOW OBJECT SIZE** : Shows the reference size of detection object.

• **Tamper**

The camera can detect severe changes in the image caused by actions such as repositioning the camera or painting over of the lens and generates an alarm to alert.

- > Mark **ENABLE** checkbox to activate the tamper alarm.
- > **DWELL TIME** : Sets the time for the tamper alarm once detected.

• **Alarm In**

- > Mark **ENABLE** checkbox to input the alarm signal from the alarm-in port.
- > **TYPE** : Lets the camera know the type of alarm contacts, NO=Normally Open & NC=Normally Close.
- > **DWELL TIME** : Sets the time for the alarm once detected by the alarm-in.

• **System**

Used to trigger the event when the camera gets rebooted.

- > Mark **ENABLE** checkbox to activate the system event.
- > **DWELL TIME** : Sets the time for the alarm once the system event is detected.

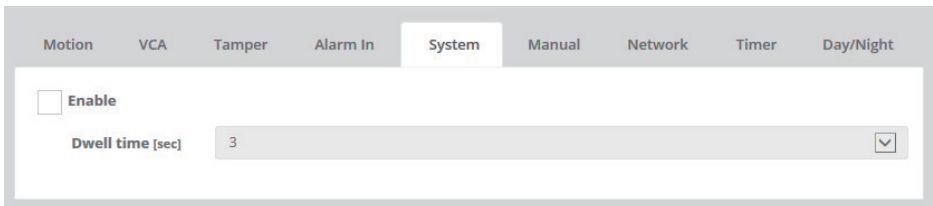

The screenshot shows a configuration interface with a top navigation bar containing tabs: Motion, VCA, Tamper, Alarm In, System (selected), Manual, Network, Timer, and Day/Night. Below the tabs, there is a section for the 'System' configuration. It includes an 'Enable' checkbox which is currently unchecked. Below the checkbox is a label 'Dwell time [sec]' followed by a text input field containing the number '3' and a dropdown arrow icon on the right side.

• **Manual** :

Enables to user to set the event trigger optionally.

- > Mark **ENABLE** checkbox to enable the manual trigger icons on the live view menu.
- > **DWELL TIME** : Sets the time for the event once triggered by the manual trigger on the live view menu.

Full Menu Setup

Motion VCA Tamper Alarm In System **Manual** Network Timer Day/Night

Manual Trigger1

Enable

Dwell time [sec] 3

Manual Trigger2

Enable

Dwell time [sec] 3

Manual Trigger3

Enable

Dwell time [sec] 3

Manual Trigger4

Enable

Dwell time [sec] 3

• Network

Used to trigger the event when the network connection fails.

> Mark ENABLE checkbox to activate the network event.

> DWELL TIME : Sets the time for the event once triggered by the network connection event.

Motion VCA Tamper Alarm In System Manual **Network** Timer Day/Night

Enable

Dwell time [sec] 3

Full Menu Setup

• *Timer*

Mark ENABLE checkbox to trigger the event as defined Timer Interval.
(Hour/Minute/Second)

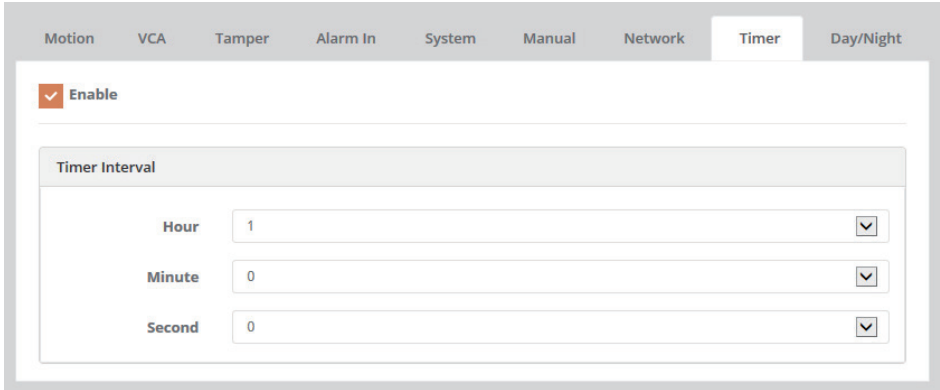

Motion VCA Tamper Alarm In System Manual Network **Timer** Day/Night

Enable

Timer Interval

Hour 1

Minute 0

Second 0

• *Day / Night*

Mark ENABLE checkbox to trigger the event when Day/Night is switched.
> MODE : Select the mode, Day->Night or Night->Day.
> DWELL TIME : Sets the interval duration for the alarm event.

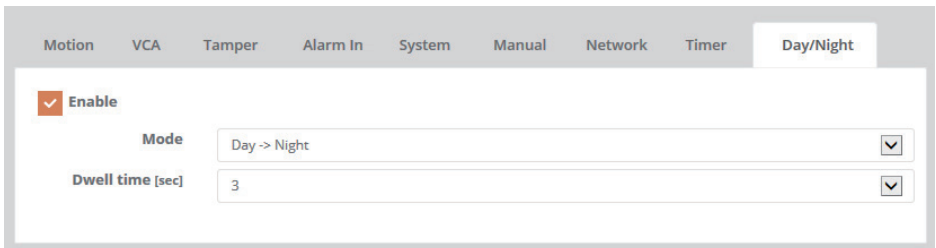

Motion VCA Tamper Alarm In System Manual Network Timer **Day/Night**

Enable

Mode Day -> Night

Dwell time [sec] 3

Full Menu Setup

3-5-2. Actions

EVENT ACTIONS menu defines and sets the parameters for how to treat the various event sources.

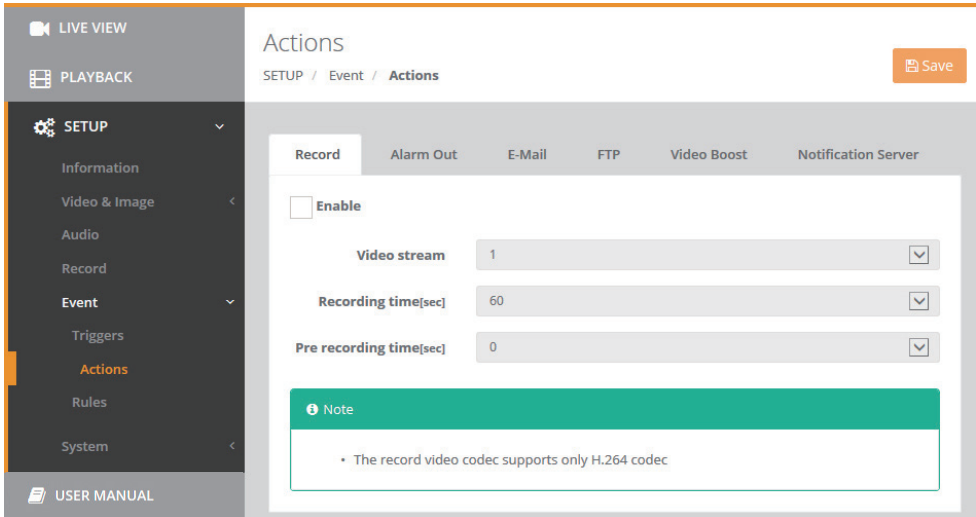

● **Record**

- > Mark ENABLE checkbox to enable recording into the built-in storage when the event occurs.
- > VIDEO STREAM : Selects the stream to be recorded when the event occurs.
- > RECORDING TIME : Sets the length of time to record after the event.
- > PRERECORDING TIME : Sets the length of time to record before the event.

● **Alarm Out**

- > Mark ENABLE checkbox to output the alarm signal to the alarm-out port.
- > TYPE : Selects the type of alarm contacts, NO=Normally Open & NC=Normally Closed.
Alarm-out port is not an actual relay contact but outputs 0V for Low level & 3.3V for High level with the current driving capacity of 50mA max.

● **E-mail**

The camera can send email messages generated by the events via SMTP (Simple Mail Transfer Protocol).

Full Menu Setup

- > Mark ENABLE checkbox to enable emailing.
 - SENDER : Enter the email address as the sender. Any virtual email address like sample@sample.com can be used if the recipient can recognize it from the camera.
 - INTERVAL : Sets the interval for emailing after the events occur.
 - AGGREGATE EVENTS : Sets the number of events which will be sent in an email.
- > Mark USE MAIL SERVER checkbox to set the mailing server.
 - MAIL SERVER : Enter the host name or IP addresses for the mail servers. If a host name is used, a valid DNS server must be specified in the Network-Basic settings.
 - PORT : Enter the port number of the mail server.

Record
Alarm Out
E-Mail
FTP
Video Boost
Notification Server

Enable

Sender

Interval [1... 86400] sec

Aggregate events [1... 100] EA

Use mail server

Mail server

Port

Enable use(SMTP) authentication

User name

Password

Login method

Receiver List

Receiver1 <input style="width: 90%;" type="text"/>	Receiver2 <input style="width: 90%;" type="text"/>
Receiver3 <input style="width: 90%;" type="text"/>	Receiver4 <input style="width: 90%;" type="text"/>
Receiver5 <input style="width: 90%;" type="text"/>	Receiver6 <input style="width: 90%;" type="text"/>
Receiver7 <input style="width: 90%;" type="text"/>	Receiver8 <input style="width: 90%;" type="text"/>

Full Menu Setup

E-Mail(SMTP) Test

Receiver

Test

- > Mark **ENABLE USE(SMTP) AUTHENTICATION** checkbox if the mail server requires authentication.
 - **USER NAME** : Enter the user name as provided by the network administrator.
 - **PASSWORD** : Enter the password as provided by the network administrator.
 - **LOGIN METHOD** : Select one for SMTP authentication method allowed.

[NOTE]

If a **PLAIN** or **LOGIN** mechanism is negotiated, the camera sends the user name and password to the SMTP server. The **LOGIN** mechanism is supported by Microsoft, as well as some other clients. Most other clients support the **PLAIN** authentication mechanism. Since the vast majority of Email clients support only **PLAIN** or **LOGIN**, mail server administrators will probably want to consider using **STARTTLS** to provide an encryption "tunnel" between the client and server to protect the user name and password.

- > **RECEIVER LIST** : Enter the recipient's email addresses as the receivers.
- > **E-MAIL(SMTP) TEST** : Enter the recipient's email address in **RECEIVER** and click the **TEST** button to test if the mail servers are functioning and the email address is valid.

• **FTP**

FTP notification will save files on the specified FTP server.

- > Mark **ENABLE** checkbox to set the FTP server.
 - **SERVER** : Enter the IP address or host name of the specific FTP server.
 - **PASSIVE MODE** : Under normal circumstances the network camera simply requests the target FTP server to open the data connection. Checking this box issues a **PASV** command to the FTP server and establishes a passive FTP connection; whereby the network camera actively initiates both the FTP control and data connections to the target server. This is normally desirable if there is a firewall between the network camera and the target FTP server.
 - **PORT** : Enter the port number used by the FTP server. The port number can be adjusted in the range 1-65535. The default setting is 21.

Full Menu Setup

- **REMOTE DIRECTORY:** Specify the path to the directory where the uploaded images will be stored. If this directory doesn't already exist on the FTP server, an error message shows up when uploading.
- **USER NAME:** Enter the user name provided by the network administrator.
- **ANONYMOUS LOGIN:** Mark ANONYMOUS LOGIN checkbox if anyone is permitted to access the FTP server.
- **PASSWORD:** Enter the password provided by the network administrator.

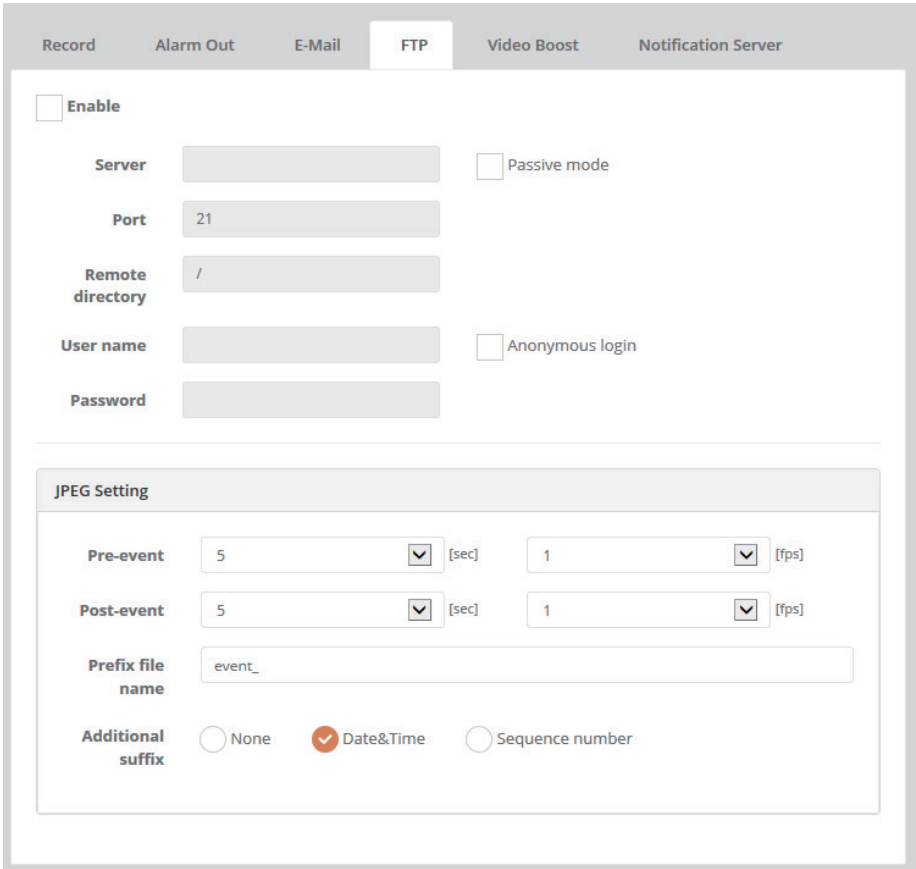

The screenshot displays the 'Full Menu Setup' interface with the 'FTP' tab selected. The interface includes a navigation bar with tabs for 'Record', 'Alarm Out', 'E-Mail', 'FTP', 'Video Boost', and 'Notification Server'. Below the navigation bar, there is a section for enabling the FTP server with the following fields and options:

- Enable
- Server: [Text Input]
- Port: 21
- Remote directory: /
- User name: [Text Input]
- Password: [Text Input]
- Passive mode
- Anonymous login

Below the FTP configuration, there is a 'JPEG Setting' section with the following fields and options:

- Pre-event: 5 [sec] (dropdown), 1 [fps] (dropdown)
- Post-event: 5 [sec] (dropdown), 1 [fps] (dropdown)
- Prefix file name: event_
- Additional suffix: None, Date&Time, Sequence number

> **JPEG SETTING :** Configures JPEG for the FTP server.

- **PRE-EVENT :** Sets the time & the frame rate for JPEG images to be sent to FTP before the event.
- **POST-EVENT :** Sets the time & the frame rate for JPEG images to be sent to FTP after the event.

Full Menu Setup

- PREFIX FILE NAME : Input the prefix for JPEG image file names to be sent to FTP.
- ADDITIONAL SUFFIX : Selects the suffix for JPEG image file names to be added after the file name. Selecting NONE will overwrite the previous file and thus DATE & TIME is most preferable.

• Video Boost

Sets the frame rate and bitrate for H.264 stream and the quality for JPEG stream at EVENT STATE when the event occurs.

[NOTE] Video boost is disabled during SD recording.

Record	Alarm Out	E-Mail	FTP	Video Boost	Notification Server
Video Boost 1					
<input type="checkbox"/> Enable					
		Normal State		Event State	
Frame rate		12.5		12.5	▼
Bitrate		6000		6000	▼
Video Boost 2					
<input type="checkbox"/> Enable					
		Normal State		Event State	
Frame rate		12.5		12.5	▼
Bitrate		2000		2000	▼
Video Boost 3					
<input type="checkbox"/> Enable					
		Normal State		Event State	
Quality		60		60	▼

Full Menu Setup

• Notification Server

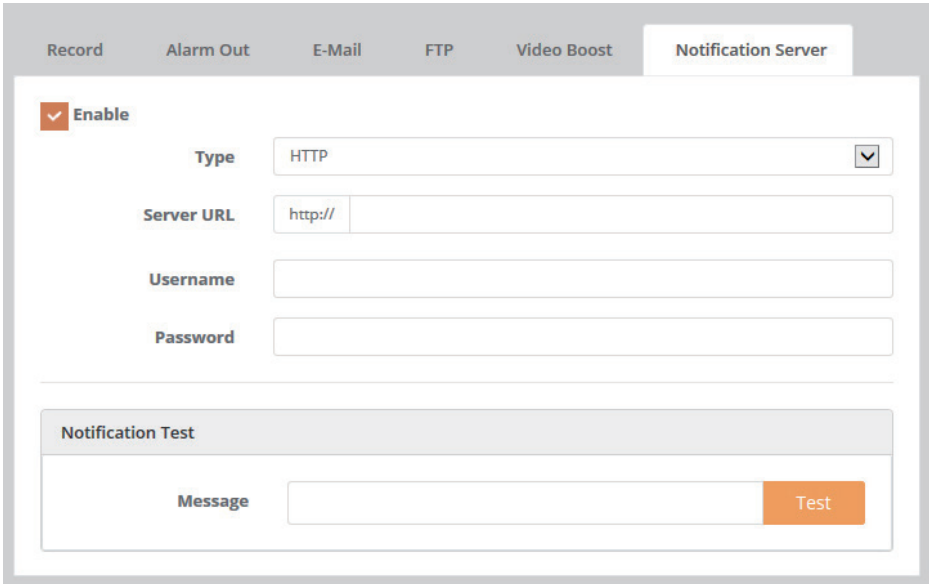

Record Alarm Out E-Mail FTP Video Boost **Notification Server**

Enable

Type HTTP ▾

Server URL http://

Username

Password

Notification Test

Message **Test**

- > Mark ENABLE checkbox to notify the event to the notification server when it occurs.
 - TYPE : Selects the network protocol to connect the notification server.
 - SERVER URL : Input the server URL of the notification sever. To enable the audio when the event occurs, copy the URL at SETUP>AUDIO and paste it on the server URL like `http://x.x.x.x/setup/audio/audio.php`
 - USERNAME : Enter the username (default : admin)
 - PASSWORD : Enter the password (default : admin)
- > NOTIFICATION TEST: Input the test message and click TEST button.

[NOTE]

There could be several event actions like FTP, e-mail etc. For detailed URL per event actions, refer to API documents. In case Notification server is set as event rule, the same URL from Notification Test should be entered in RULE>ADD>NOTIFICATION SERVER.

Full Menu Setup

3-5-3. Rules

EVENT RULES menu defines and sets the parameters for what to do for the various event sources.

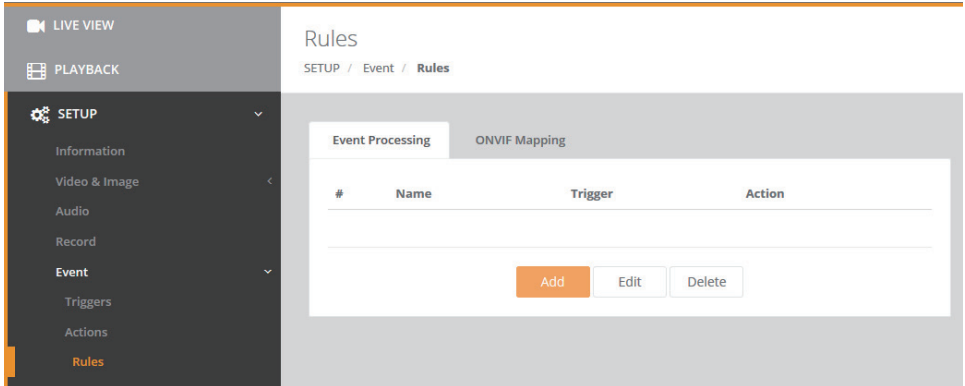

• **Event Processing**

Event process lists have to be generated and can be edited for what to do when the event occurs. List shows the rule name, trigger source and type of action for each event process. To edit or delete the rule in the list, click the listed line and then click EDIT or DELETE button.

ADDING & EDITING RULES

> NAME : Input the rule name which is descriptive to the rule.

EVENT TRIGGER

> TYPE : Select the type of the event trigger source.

EVENT ACTION

> ALARM OUT : Mark the checkbox to activate the alarm-out port, if available, as set in SETUP>EVENT> ACTIONS>ALARM OUT when the selected event occurs.

> E-MAIL :

- Input the email addresses to be emailed.
- Mark the checkbox for the email addresses to be emailed as set in SETUP>EVENT> ACTIONS>E-MAIL when the selected event occurs
- SUBJECT of email is a required field and ADDITIONAL INFO is optional to input.

> NOTIFICATION SERVER: Mark the checkbox to use the notification server as set in SETUP>EVENT> ACTIONS> NOTIFICATION SERVER when the selected event occurs.

- MESSAGE : Input the message to be sent to the notification server.

Full Menu Setup

- > FTP : Mark the checkbox to use FTP as set in SETUP>EVENT>ACTIONS>FTP when the selected event occurs.
- > VIDEO BOOST : Select the video stream to be boosted up.
[NOTE] Video boost is disabled if RECORD is enabled.
- > RECORD : Mark the checkbox to record the image into the built-in storage, if available, as set in SETUP>EVENT>ACTIONS>RECORD when the selected event occurs.

Add Rule

Name

Event Trigger

Type ▼

Event Action

Alarm out

E-Mail

Address1 Address2

Address3 Address4

Address5 Address6

Address7 Address8

Subject

Additional info

Notification Server

Message

FTP

Video Boost Video1 Video2 Video3

Note

- Please note that Video Boost does not work during SD recording

Record

OK Close

Full Menu Setup

• **ONVIF Mapping**

Onvif mapping is provided to map the various events generated by this camera, but not defined by Onvif, to assign them to Onvif events for the Onvif compatible VMSeS or NVRs. Two mappings for Motion and Alarm In are provided to be mapped and can be used by editing them.

For example, any of the selected items in tns1:VideoSource/MotionAlarm will notify the Onvif compatible VMSeS or NVRs as Motion Alarm. In the same way, any of the selected items in tns1: Device/Trigger/Digital Input will notify the Onvif compatible VMSeS or NVRs as Alarm IN.

#	Event Topic	Event Notification	
1	tns1:VideoSource/MotionAlarm	Motion Detection	<input type="button" value="Edit"/>
2	tns1:Device/Trigger/DigitalInput	Network Loss	<input type="button" value="Edit"/>

Full Menu Setup

3-6. System

3-6-1. Security

The screenshot shows the 'Security' configuration page. On the left is a sidebar with 'LIVE VIEW', 'PLAYBACK', and 'SETUP' (expanded to show 'Security'). The main area is titled 'Security' and contains a 'Save' button. Below the title are tabs for 'Users', 'HTTPS', 'IP Filter', 'ONVIF', 'Video Stream', and 'Export / Import'. The 'Users' tab is active, showing a checkbox for 'Enable anonymous viewer login' and a table of users.

#	Name	Group	Authority
1	admin	administrator	live, setup, system

Buttons for 'Add', 'Edit', and 'Delete' are located below the table.

• Users

Manages the user accounts by names, groups and authorities.

- > Mark ENABLE ANONYMOUS VIEWR LOGIN if anyone is permitted to login anonymously. Accessing SETUP menu with the anonymous login will exit and require ID/Password login.
- > USERS : Can be added, edited or deleted.

The 'Add User' dialog box contains the following fields:

- Name: [Text input field]
- Password: [Text input field]
- Confirm Password: [Text input field]
- Group: [Dropdown menu with 'guest' selected]

Buttons: OK, Close

The 'Edit User' dialog box contains the following fields:

- Name: [Text input field with 'admin' value]
- Password: [Text input field]
- Confirm Password: [Text input field]
- Group: [Dropdown menu with 'administrator' selected]

Buttons: OK, Close

Full Menu Setup

• HTTPS

Selects the CONNECTION MODE.

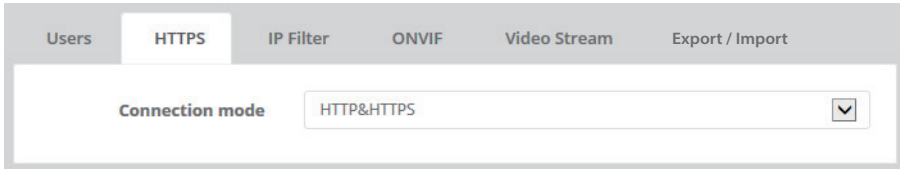

Users | **HTTPS** | IP Filter | ONVIF | Video Stream | Export / Import

Connection mode: HTTP&HTTPS

- > HTTP : Transfers data without encryption. Supports a URL that only starts with "HTTP: "
- > HTTPS : Transfer data with encryption by Hypertext Transfer Protocol over SSL protocol. Supports a URL that only starts with "HTTPS: "
- > HTTP&HTTPS : Supports both HTTP and HTTPS protocols.

[NOTE]

To ensure security on the internet, all web browsers provide several security levels that can be adjusted for sites that use SSL (Secure Socket Layer) technology to transfer data. SSL encrypts communications, making it difficult for unauthorized users to intercept and view user names and passwords. SSL requires signed certificates to determine if the web browser accessing the camera has the required authentication. This camera can generate a self-signed certificate using Open SSL.

• IP Filter

- > Mark ENABLE IP ADDRESS FILTERING to filter the IP addresses.
- > Mark ON/OFF for the IP address range to use IP filtering.
- > Select ALLOW or DENY to permit or filter out the IP address range.
- > Input the IP address ranges with START IP and END IP.

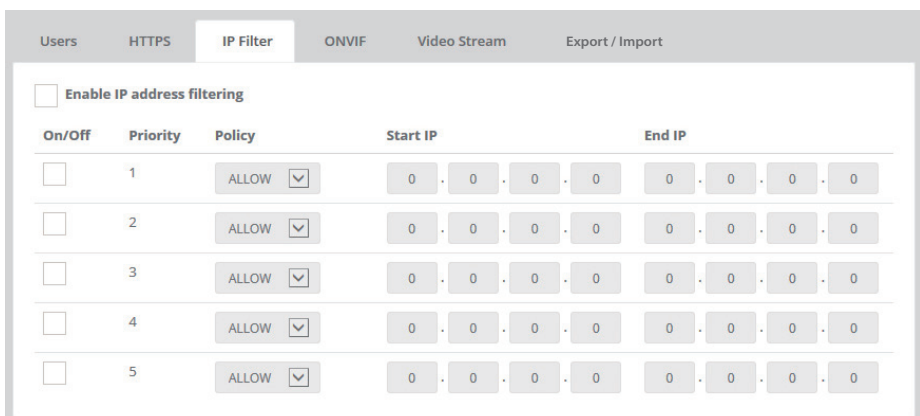

Users | HTTPS | **IP Filter** | ONVIF | Video Stream | Export / Import

Enable IP address filtering

On/Off	Priority	Policy	Start IP	End IP
<input type="checkbox"/>	1	ALLOW <input type="checkbox"/>	0 . 0 . 0 . 0	0 . 0 . 0 . 0
<input type="checkbox"/>	2	ALLOW <input type="checkbox"/>	0 . 0 . 0 . 0	0 . 0 . 0 . 0
<input type="checkbox"/>	3	ALLOW <input type="checkbox"/>	0 . 0 . 0 . 0	0 . 0 . 0 . 0
<input type="checkbox"/>	4	ALLOW <input type="checkbox"/>	0 . 0 . 0 . 0	0 . 0 . 0 . 0
<input type="checkbox"/>	5	ALLOW <input type="checkbox"/>	0 . 0 . 0 . 0	0 . 0 . 0 . 0

Full Menu Setup

[**NOTE**] To add a subnet of network addresses, these must be added in CIDR (Classless Inter-Domain Routing) notation. For example: entering 192.168.1.0/24 will add all the addresses in the range 192.168.1.1 to 192.168.1.254. Contact your network administrator for more detail. If the network camera is accessed via a proxy server, the IP address for the proxy server must be added as an allowed address.

• **ONVIF**

> Mark ENABLE WS SECURITY to provide the ONVIF compliance.

• **Video Stream**

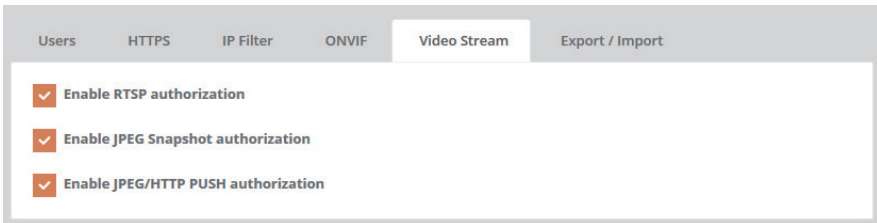

> ENABLE RTSP AUTHORIZATION : If marked, the authorization is required when the stream 1/2/3 is accessed using RTSP.

> ENABLE JPEG SNAPSHOT AUTHORIZATION : If marked, the authorization is required when the Jpeg snapshot image is requested.

> ENABLE JPEG/HTTP PUSH AUTHORIZATION : If marked, the authorization is required when the Jpeg/HTTP PUSH image is requested.

• **Export / Import**

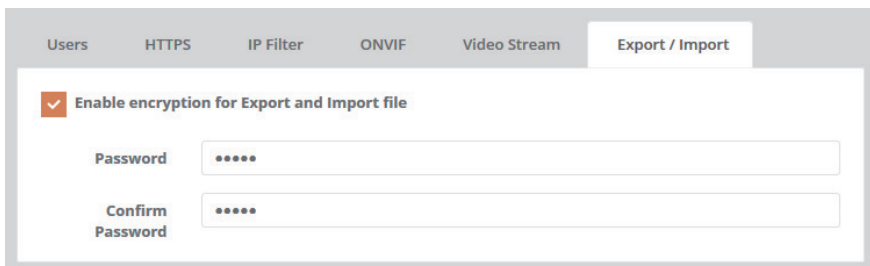

> Mark ENABLE ENCRPTION FOR EXPORT AND IMPORT FILE :
System configuration file, which is exported at SETUP>SYSTEM>MAINTENANCE>SETUP EXPORT, is encrypted with the password herein.

[**NOTE**] THIS PASSWORD MUST BE USED when System configuration file is imported by other cameras if the file was exported with the password.

> If the checkbox is not marked, system configuration file is exported without encryption.

Full Menu Setup

3-6-2. Date & Time

- **Current Time**

Shows the current date and time. Clicking SAVE tap updates and saves the date and time with the selected time in NEW TIME.

- **New Time**

Select one of the following server times.

- > SYNCHRONIZE WITH COMPUTER TIME : Obtains the time from the computer.
- > SET MANUALLY : Sets the date and time manually.
- > SYNCHRONIZE WITH NTP SERVER : Obtains the time from the assigned NTP server at every hour in INTERVAL. The NTP server's IP address or host name has to be specified in the time server.

- **Time Zone**

Select the time zone to be referenced to the NTP server where the camera is installed. Mark AUTOMATICALLY ADJUST FOR DAYLIGHT SAVING CHANGES check box to update the time automatically with daylight savings.

- **Date & Time Display**

Select the date & time formats to be displayed.

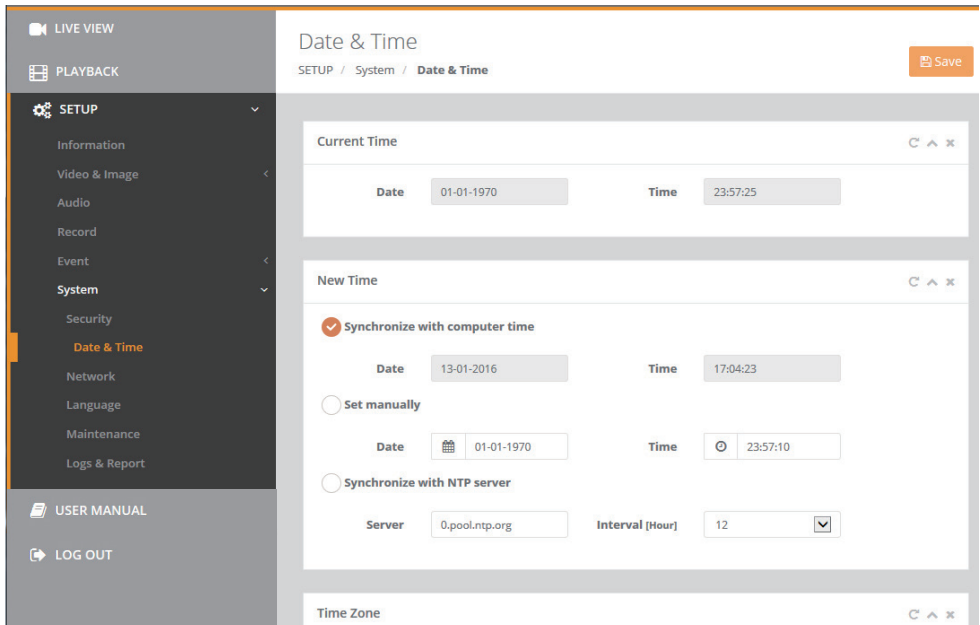

The screenshot displays the 'Date & Time' configuration page. On the left, a sidebar menu lists various setup categories, with 'Date & Time' highlighted. The main area is titled 'Date & Time' and includes a 'Save' button in the top right. The configuration is organized into three main sections:

- Current Time:** Shows the current system date as '01-01-1970' and time as '23:57:25'.
- New Time:** Offers three synchronization methods:
 - Synchronize with computer time:** This option is selected. It shows a date of '13-01-2016' and a time of '17:04:23'.
 - Set manually:** Shows a date of '01-01-1970' and a time of '23:57:10'.
 - Synchronize with NTP server:** Shows a server address of '0.pool.ntp.org' and an interval of '12' hours.
- Time Zone:** This section is partially visible at the bottom of the screen.

Full Menu Setup

3-6-3. Network

• TCP/IP

> IPv4 ADDRESS :

- **OBTAIN IP ADDRESS VIA DHCP** : Gets the IP address assigned by the DHCP (Dynamic Host Configuration Protocol) server.
- **STATUS** : 'Allocated' shows that the IP address is obtained from the DHCP.
- **IP ADDRESS, SUBNET MASK, GATEWAY** : Displays the current IP address which is obtained from the DHCP.
- **USE THE FOLLOWING ADDRESS** : Requires the input of a static IP address manually.

> IPv6 ADDRESS : Mark ENABLE check box to use IPv6 address and click SAVE button, then new IPv6 address will be obtained.

> DNS :

- **OBTAIN DNS ADDRESS VIA DHCP SERVER** : Obtains the DNS address automatically assigned by DHCP server.
- **USE THE FOLLOWING DNS ADDRESS** : Requires manual input as per below.
 - **DOMAIN NAME** : Enter the domain for the host name
 - **PRIMARY DNS SERVER** : Enter the IP address of the primary DNS server.
 - **SECONDARY DNS SERVER** : Enter the IP address of the secondary DNS server.

> HOSTNAME : This camera can be accessed using a host name instead of an IP address. The host name is usually the same as the assigned DNS name.

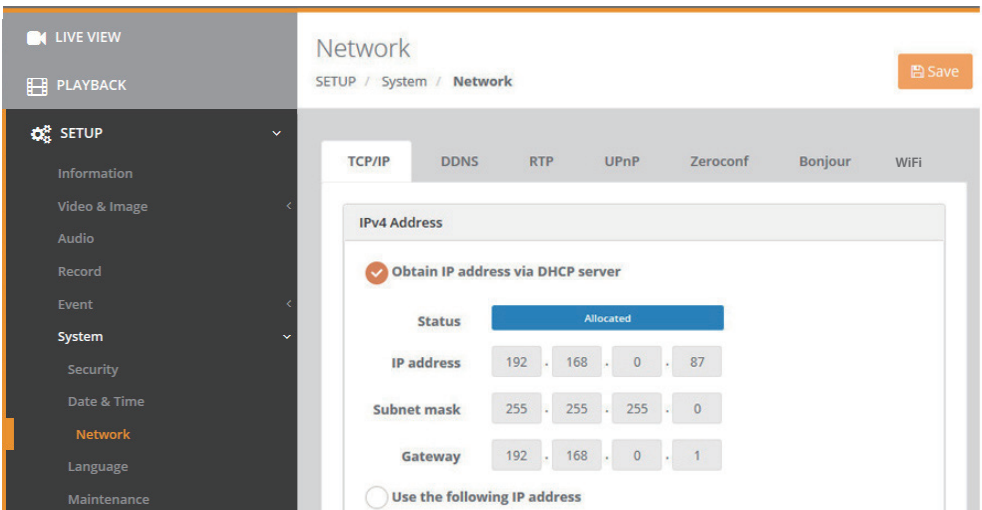

The screenshot shows the 'Network' setup page in a web interface. The left sidebar contains navigation options: LIVE VIEW, PLAYBACK, and SETUP (expanded). Under SETUP, 'Network' is highlighted. The main content area is titled 'Network' and includes a breadcrumb 'SETUP / System / Network' and a 'Save' button. The 'TCP/IP' tab is selected, showing the 'IPv4 Address' configuration. The 'Obtain IP address via DHCP server' option is checked, and the status is 'Allocated'. The IP address is 192.168.0.87, the subnet mask is 255.255.255.0, and the gateway is 192.168.0.1. The 'Use the following IP address' option is unselected.

Full Menu Setup

IPv6 Address

Enable

IPv6 address

DNS

Obtain DNS address via DHCP server

Use the following DNS address

Domain name

Primary DNS · · ·

Secondary DNS · · ·

Hostname

Hostname

Port

HTTP port

HTTPS port

RTSP port

> PORT :

- HTTP PORT : Use a port number in the range 1024-65535. Default is 80.
- HTTPS PORT : Use a port number in the range 1024-65535. Default is 443.
- RTSP PORT : Use a port number in the range 1024-65535. Default is 554.

Full Menu Setup

- **DDNS** (Dynamic Domain Naming Service)

- > Mark ENABLE checkbox to use DDNS.
- > DDNS server : Select the DDNS server to use.
- > Input REGISTERED HOST name, USER NAME, PASSWORD and INTERVAL.

[NOTE] If the camera has not been registered to the DDNS host previously, the registration is required. If the camera is already registered but its IP address changes, the DDNS must be updated with this new IP address. It will update at a regular interval.

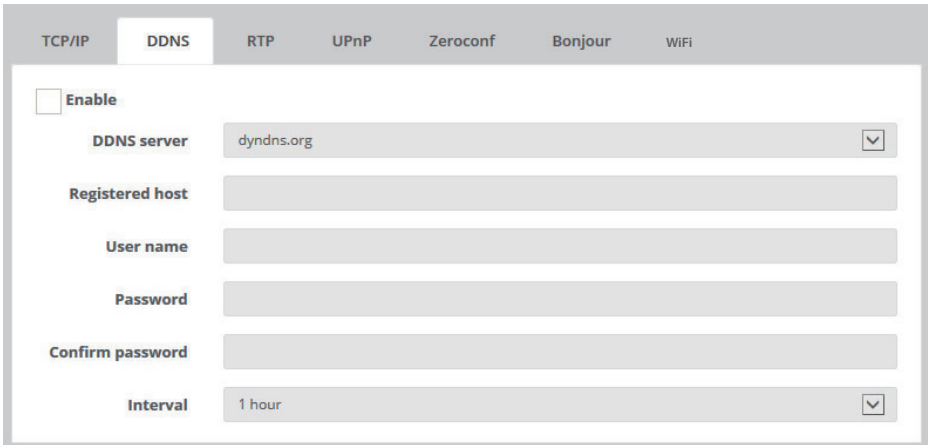

The screenshot shows the DDNS configuration page. At the top, there are tabs for different settings: TCP/IP, DDNS (which is active), RTP, UPnP, Zeroconf, Bonjour, and WIFI. Below the tabs, there is a section for DDNS configuration. It starts with an 'Enable' checkbox. Below that, there are several fields: 'DDNS server' (a dropdown menu showing 'dyndns.org'), 'Registered host' (a text input field), 'User name' (a text input field), 'Password' (a text input field), 'Confirm password' (a text input field), and 'Interval' (a dropdown menu showing '1 hour').

- **RTP**

- > START PORT & END PORT : RTP port range defines the range of the ports from which ports of the video/audio are automatically selected. This feature is useful if the camera is connected to a NAT router with manually configured port mapping. Limit the range of the ports permitted for RTP unicast/multicast by entering START PORT and END PORT.
- > MULTICAST - STREAM1, 2, 3 : Only IP addresses within certain ranges can be used for multicasting. The camera has been pre-configured with addresses from these ranges and does not normally need to be reconfigured. If an address needs to be changed, please contact the network administrator.
 - Mark ENABLE checkbox to use the multicast for each stream.
 - DESTINATION IP: Type IP address in the range. Multicast addresses are allocated according to these IANA policies.
 - PORT : Use the port number in the range 1024-65532. Default is 4000.
 - TTL : When IP packets or data fails to be delivered to the destination within TTL (Time To Live), this setting tells the network router when to discard the packet. The value is usually measured in 'hops', i.e. the number of network routers that can be passed before the packet arrives at its destination or is dropped.

Full Menu Setup

TCP/IP DDNS **RTP** UPnP Zeroconf Bonjour WiFi

Start port: [30000... 39800; Only even values are available]

End port:

Multicast - Stream 1

Enable

Destination IP: · · · [224.0.0.0... 239.255.255.255]

Port: [1024... 65530; Only even values are available]

TTL: [1... 255]

Multicast - Stream 2

Enable

Destination IP: · · · [224.0.0.0... 239.255.255.255]

Port: [1024... 65530; Only even values are available]

TTL: [1... 255]

Multicast - Stream 3

• UPnP

UPnP is enabled by default so that the network camera can be automatically detected by operating systems and clients that support this protocol.

> FRIENDLY NAME : Enter the name up to 32 alphanumeric characters like Model Name-MAC address.

[NOTE]

UPnP must also be enabled on your Windows computer. To do this, open the Control Panel from the Start Menu and select Add/Rename programs. Select Add / Remove Windows Components and open the Networking Services section. Click Details and then select UPnP as the service to add.

TCP/IP DDNS RTP **UPnP** Zeroconf Bonjour WiFi

Enable

Friendly name:

Full Menu Setup

• Zeroconf

ZeroConf (Zero configuration) networking enables the network to establish automatically with the automatic assignment of numeric network addresses (zeroconf IP addresses) without requiring manual operator intervention or special configuration servers when the DHCP server is not available in the network.

- > Mark ENABLE to use ZeroConf networking.
- > ZeroConf ADDRESS : 169.254.xxx.xxx as default.



TCP/IP DDNS RTP UPnP **Zeroconf** Bonjour WiFi

Enable

Zeroconf address 169.254.100.181

• Bonjour

Bonjour is Apple's implementation of zero-configuration networking (zeroconf), a group of technologies that includes service discovery, address assignment, and hostname resolution.

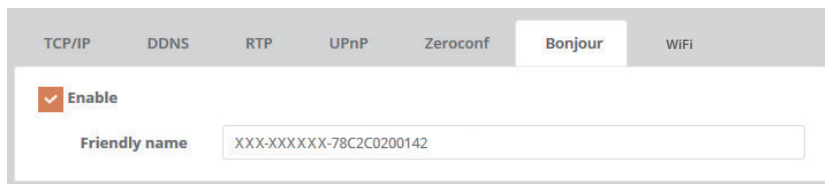

TCP/IP DDNS RTP UPnP Zeroconf **Bonjour** WiFi

Enable

Friendly name XXX-XXXXXX-78C2C0200142

• WiFi

- > WiFi IP address: Shows the WiFi IP address
- > MODE :
 - Off - Disables the WiFi access.
 - On - Enable the WiFi access
 - Timer - Disables the WiFi access after certain period of time, as set in Timer[hour].
- > TIMER [hour] : Available to set in 1~24 hours.

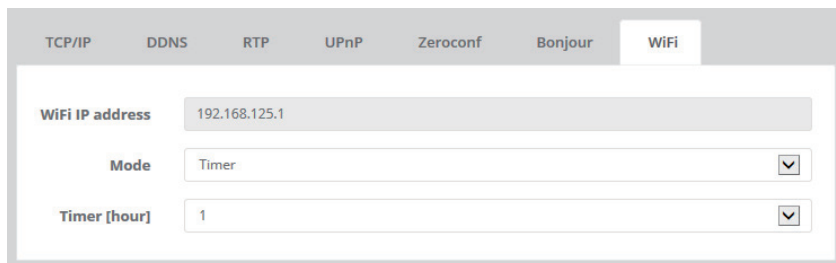

TCP/IP DDNS RTP UPnP Zeroconf Bonjour **WiFi**

WiFi IP address 192.168.125.1

Mode Timer

Timer [hour] 1

Full Menu Setup

3-6-4. Language

Six languages are available to select from English, Deutsch (German), Français (French), Polski (Polish), Suomi (Finnish), and 한국어 (Korean).

3-6-5. Maintenance

Maintenance

SETUP / System / Maintenance

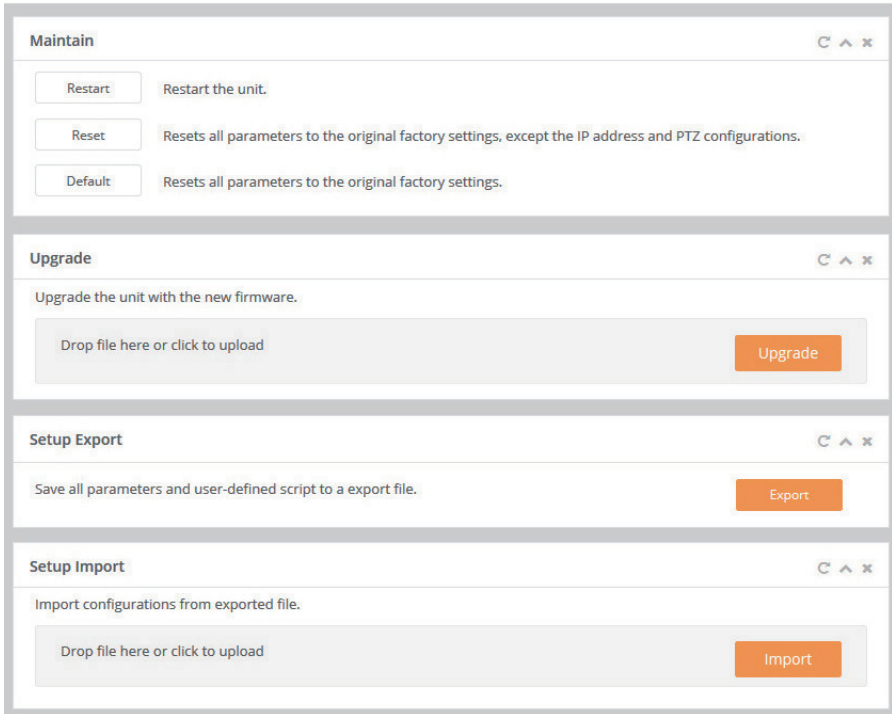

• **Maintain**

- > RESTART : Restarts the camera without changing any settings.
- > RESET : Restarts and loads the factory settings but does not change IP address and PTZ settings.
- > DEFAULT : Loads and saves the factory defaults for all parameters including IP address and PTZ settings.

[CAUTION]

Do not disconnect the power or network cable during RESET or DEFAULT operations.

Full Menu Setup

• Upgrade

Bring the firmware file to the drop box or click the drop box to browse for the firmware file, and then click the UPGRADE button.

[CAUTION] Do not disconnect the power or network cable during firmware UPGRADE.

• Setup Export

Current configurations for the camera can be saved as a file by clicking the EXPORT button.

• Setup Import

The exported configuration file from a reference camera or a backup configuration can be imported and configured/reloaded onto other cameras.

[NOTE]

- SETUP EXPORT/SETUP IMPORT can only be used on the same camera models with the same firmware. This feature is not intended for the configuration of multiple units or for firmware upgrades.
- When the encrypted System configuration file with the password is imported, type the password at SETUP>SYSTEM>SECURITY>EXPORT/IMPORT with the SAME password which was used in exporting the system configuration file from the reference camera. Otherwise, 'INVALID FILE' error appears.

3-6-6. Logs & Report

• Logs

The log file records the story into the unit since the system restarts.

> DATABASE CAPACITY: Shows the useable system memory space for Log file.

> SEARCH CONDITION: Allows you to search the log as per the type. E.g. System, Access, Event and Media, Start-End date and Start-End time.

> LOG LIST: Shows the logs as per the search.

• Report

Provides overall information about the server status.

4. USER MANUAL

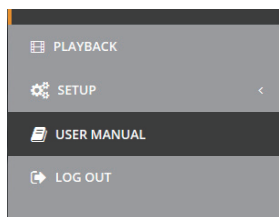

Help the menu function.

Click and pop-up the page about current menu description.

Troubleshooting

If you suspect a problem is being caused by incorrect configuration or some other minor problem, consult the troubleshooting guide below.

Upgrading the Firmware

Firmware is software that determines the functionality of the network camera. One of your first actions when troubleshooting a problem should be to check the current firmware. The latest version may contain a correction that fixes your particular problem. The current firmware version in your camera is displayed on the Basic Configuration or About. For the latest firmware of the camera, please contact with your product administrator.

Detailed instructions on how to perform the upgrade process are provided with each new release.

General Troubleshooting

The following list covers some of the problems that may be encountered and suggests how to remedy them:

Symptom	Guide
The camera cannot be accessed by some clients.	If using a proxy server, try disabling the proxy setting in your browser. Check all cabling and connectors.
The camera works locally, but not externally	Check if there are firewall settings that need to be adjusted. Check if there are router settings that need to be configured.
Poor or intermittent network connection.	If using a network switch, check that the port on that device uses the same setting for the network connection type (speed/duplex).
The camera cannot be accessed via a host name.	Check that the host name and DNS server settings are correct.
Not possible to log in.	When HTTPS is enabled, ensure that the correct protocol (HTTP or HTTPS) is used. When attempting to log in, you may need to manually type in http or https in the browser's address bar.
No image using Refresh and/or slow updating of images.	If images are very complex, try limiting the number of clients accessing the camera.
Images only shown in black & white.	Check the Video & Image setting.
Blurred images.	Refocus the camera.

Troubleshooting

Poor image quality.	Increased lighting can often improve image quality. Check that there is sufficient lighting at the monitored location. Check all image and lighting settings.
Rolling dark bands or flickering in image.	Try adjusting the Exposure Control setting under AE and AWB part.
H.264 not displayed in the client.	Check that the correct network interface is selected in the Video & Image/Stream.
Multicast H.264 not displayed in the client.	Check with your network administrator that the multicast addresses used by the camera are valid for your network. Check that the Enable multicast checkbox are enabled in the System/Network/RTP tab. Checks with your network administrator to see if there is a firewall preventing viewing.
Multicast H.264 only accessible by local clients.	Check if your router supports multicasting, or if the router settings between the client and the server need to be configured. The TTL value may need to be increased.
Color saturation is different in H.264 and Motion JPEG.	Modify the settings for your graphics adapter. Please see the adapter's documentation for more information.
Poor audio quality.	Too many users/clients connected to the camera may affect the sound quality adversely. Try limiting the number of clients allowed to connect.
Distorted audio.	Check that the correct Audio Input source is selected. Select Microphone for a connected external microphone. Select Line for a connected line in source.

[NOTE]

If you cannot find the help you require, please see the User's Manual, or contact with your network administrator.



eneo® is a registered trademark of
VIDEOR E. Hartig GmbH
Exclusive distribution through specialised
trade channels only.

VIDEOR E. Hartig GmbH
Carl-Zeiss-Straße 8
63322 Rödermark/Germany
Tel. +49 (0) 6074 / 888-0
Fax +49 (0) 6074 / 888-100
www.videor.com
www.eneo-security.com

Technical changes reserved

© Copyright by VIDEOR E. Hartig GmbH
Version 11/2017