

Manual

Important: Note that XSNet Series manuals may cover multiple models. To establish if a particular feature or specification in this manual applies to the unit at hand, consult the datasheet of the given model.

Note: The EU Declaration of Conformity for this product can be found at www.siqura.com/support-files.

Quick Start Guide



This quick start guide describes how to install and use the Industrial Managed Ethernet Switch. This is the switch of choice for harsh environments constrained by space.

Physical Description

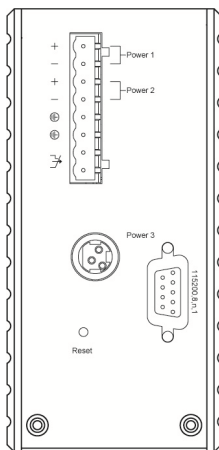
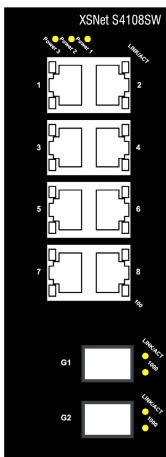
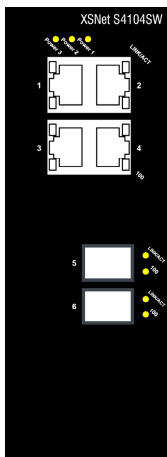
The Port Status LEDs and Power Inputs



| | | |
|----------------------------|----------|---|
| LED | State | Indication |
| Power 1 | Steady | Power on |
| Power 2 Power 3 | Off | Power off |
| 10/100Base-TX, 100Base SFP | | |
| LINK/ACT | Steady | A valid network connection established |
| | Flashing | Transmitting or receiving data ACT stands for ACTIVITY |
| 100 | Steady | Connection at 100Mbps speed |
| 1000Base SFP | | |
| LINK/ACT | Steady | A valid network connection established |
| | Flashing | Transmitting or receiving data ACT stands for ACTIVITY |
| 1000 | Steady | Connection at 1000Mbps speed |

| | | | |
|--|---|--------------|-------------------|
| Power Input Assignment | | | |
| Power3 | | 12VDC | DC Jack |
| Power2 | + | 12-48VDC | Terminal Block |
| | - | Power Ground | |
| Power1 | + | 12-48VDC | |
| | - | Power Ground | |
|  | | Earth Ground | |
| Relay Output Rating | | | 1A @ 24VDC |
| Relay Alarm Assignment | | | |
|  FAULT | *Warning signal disable for following: The relay contact closes if Power1 and Power2 are both failed but Power3 on. The relay contact closes if Power3 is failed but Power1 and Power2 are both on. | | |

Functional Description

- Meets EN61000-6-2 & EN61000-6-4 EMC Generic Standard Immunity for industrial environment.
- Manageable via SNMP, Web-based, Telnet, and RS-232 console port.
- Supports Command Line Interface in RS-232 console.
- Supports 802.3/802.3u/802.3ab/802.3z/802.3x. Auto-negotiation: 10/100/1000Mbps, full/half-duplex. Auto MDI/MDIX.
- The S4104SW is equipped with 2x 100Base-FX SFP slots.
- The S4108SW is equipped with 2x 1000Base-FX SFP slots.
- Supports 8192 MAC addresses. Provides 2M bits memory buffer.

- Alarms for power and port link failure by relay output.
- Power Supply: Redundant DC Terminal Block power inputs or 12VDC DC JACK with 100-240VAC external power supply.
- Operating voltage and Max. current consumption: 0.92A @ 12VDC, 0.46A @ 24VDC, 0.23A @ 48VDC. Power consumption: 11W Max.
- -10°C to 60°C (14°F to 140°F) operating temperature range. Tested for functional operation @ -20°C to 70°C (-4°F to 158°F).
- Supports DIN-Rail and Panel Mounting installation.

Console Configuration

- Connect to the switch console:
Connect the DB9 straight cable to the RS-232 serial port of the device and the RS-232 serial port of the terminal or computer running the terminal emulation application. Direct access to the administration console is achieved by directly connecting a terminal or a PC equipped with a terminal-emulation program (such as HyperTerminal) to the switch console port.
- Configuration settings of the terminal-emulation program:
Baud rate: 115,200bps
Data bits: 8
Parity: none
Stop bit: 1
Flow control: none
- Press the “Enter” key. The Command Line Interface (CLI) screen should appear as below:
- Logon to Exec Mode (View Mode):
At the “switch_a login:” prompt just type in “root” and press <Enter> to logon to Exec Mode (or View Mode). And the “switch_a>” prompt will show on the screen.

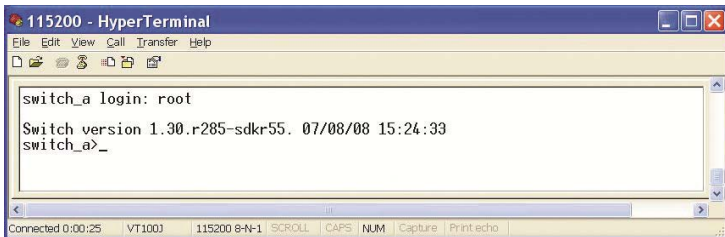

```
115200 - HyperTerminal
File Edit View Call Transfer Help
switch_a login: root
Switch version 1.30.r285-sdkr55. 07/08/08 15:24:33
switch_a>_
Connected 0:00:25 | VT1003 | 115200 8-N-1 | SCROLL | CAPS | NUM | Capture | Print echo
```

- Logon to Privileged Exec Mode (Enable Mode):
At the “switch_a>” prompt just type in “enable” and press <Enter> to logon to Privileged Exec Mode (or Enable Mode). And the “switch_a#” prompt will show on the screen.
- Logon to Configure Mode (Configure Terminal Mode):
At the “switch_a#” prompt just type in “configure terminal” and press <Enter> to logon to Configure Mode (or Configure Terminal Mode). And the “switch_a(config)#” prompt will show on the screen.
- Set new IP address and subnet mask for Switch:
At the “switch_a(config)#” prompt just type in “interface vlan1.1” and press <Enter> to logon to vlan 1 (vlan1.1 means vlan 1). And the “switch_a(config-if)#” prompt will show on the screen.
Command Syntax: “ip address A.B.C.D/M”. “A.B.C.D” specifies IP address. “M” specifies IP subnet mask. “M”= 8: 255.0.0.0, 16:255.255.0.0, or 24: 255.255.255.0.
For example, At the “switch_a(config-if)#” prompt just type in “ip address 192.168.1.10/24” and press <Enter> to set new IP address (192.168.1.10) and new IP subnet mask (255.255.255.0) for Switch.

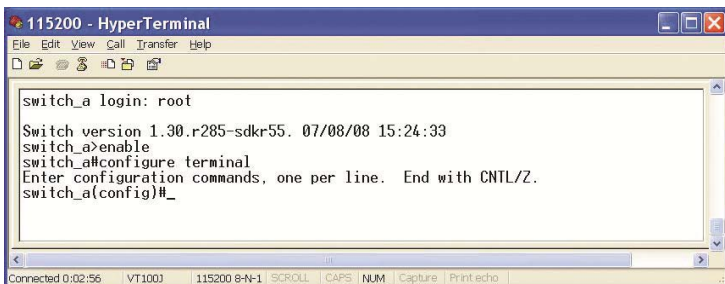

```
115200 - HyperTerminal
File Edit View Call Transfer Help
switch_a login: root
Switch version 1.30.r285-sdkr55. 07/08/08 15:24:33
switch_a>enable
switch_a#configure terminal
Enter configuration commands, one per line. End with CNTL/Z.
switch_a(config)#_
Connected 0:02:56 | VT1003 | 115200 8-N-1 | SCROLL | CAPS | NUM | Capture | Print echo
```

Web Configuration

- Login the switch:
Specify the default IP address (192.168.1.10) of the switch in the web browser. A login window will be shown as below:

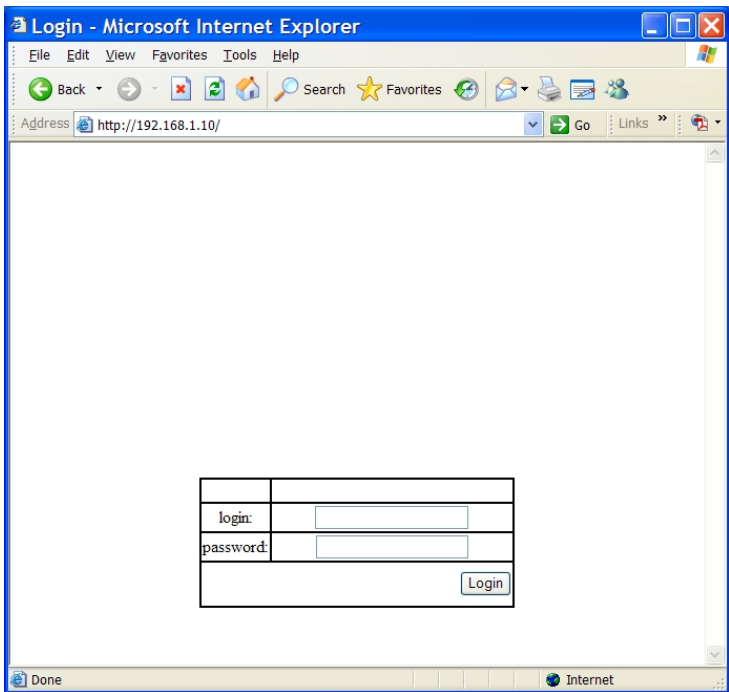

- Enter the factory default login ID: root.
Enter the factory default password (no password).
Then click on the "Login" button to log on to the switch.

Welcome to Switch Management - Microsoft Internet Explorer

File Edit View Favorites Tools Help

Address <http://192.168.1.10/cgi-bin/switch.cgi> Go Links



Management Switch

- System
- Port
- Switching
- Trunking
- STP / Ring
- VLAN
- QoS
- SNMP
- 802.1x
- Other Protocols

| System information | |
|--------------------|------------------------------|
| System name | switch_a |
| Firmware version | 1.93.1-CA 06/20/13 17:44:04 |
| System time | Fri Jan 01 12:06:00 PST 2010 |
| MAC address | 0004.7e00.0001 |
| Default gateway | None |
| DNS Server | None |

| VLAN ID | IP Address | IP Subnet Mask |
|---------|--------------|----------------|
| 1 | 192.168.1.10 | 255.255.255.0 |

Done Internet

Preface

This manual describes how to install and use the Industrial Managed Ethernet Switch. This switch introduced here is designed to deliver full scalability with SNMP/RMON web-based management functions by providing:

To get the most out of this manual, you should have an understanding of Ethernet networking concepts.

In this manual, you will find:

Features on the Industrial Managed Ethernet Switch

- Illustrative LED functions
- Installation instructions
- Management Configuration
- SNMP, IGMP...
- Specifications

Table of Contents

| | |
|--|-----------|
| Quick Start Guide | 1 |
| PHYSICAL DESCRIPTION | 1 |
| <i>The Port Status LEDs and Power Inputs</i> | 1 |
| FUNCTIONAL DESCRIPTION..... | 2 |
| CONSOLE CONFIGURATION | 3 |
| WEB CONFIGURATION | 5 |
| Preface | 7 |
| Table of Contents | 8 |
| Product Overview | 10 |
| INDUSTRIAL MANAGED ETHERNET SWITCH | 10 |
| PACKAGE CONTENTS | 10 |
| PRODUCT HIGHLIGHTS | 11 |
| <i>Basic Features</i> | 11 |
| <i>Management Support</i> | 11 |
| FRONT PANEL DISPLAY | 13 |
| PHYSICAL PORTS..... | 14 |
| SWITCH MANAGEMENT..... | 15 |
| <i>Web-based browser interface</i> | 15 |
| <i>Administration console via RS-232 serial port (CLI)</i> | 15 |
| <i>External SNMP-based network management application</i> | 15 |
| Installation | 16 |
| SELECTING A SITE FOR THE SWITCH..... | 16 |
| CONNECTING TO POWER..... | 17 |
| <i>12VDC DC Jack</i> | 17 |
| <i>Redundant DC Terminal Block Power Inputs</i> | 17 |
| <i>Alarms for Power Failure</i> | 17 |
| CONNECTING TO YOUR NETWORK | 18 |
| <i>Cable Type & Length</i> | 18 |
| <i>Cabling</i> | 20 |
| Switch Management | 21 |
| MANAGEMENT ACCESS OVERVIEW | 21 |
| ADMINISTRATION CONSOLE (CLI) | 22 |
| <i>Direct Access</i> | 22 |
| WEB MANAGEMENT | 23 |
| SNMP-BASED NETWORK MANAGEMENT | 23 |
| PROTOCOLS | 24 |
| MANAGEMENT ARCHITECTURE | 24 |

| | |
|---|------------|
| SNMP & RMON Management | 25 |
| OVERVIEW | 25 |
| SNMP AGENT AND MIB-2 (RFC 1213) | 26 |
| RMON MIB (RFC 2819) AND BRIDGE MIB (RFC 1493) | 26 |
| <i>RMON Groups Supported</i> | 27 |
| <i>Bridge Groups Supported</i> | 27 |
| Web-Based Browser Management | 28 |
| LOGGING ON TO THE SWITCH | 28 |
| UNDERSTANDING THE BROWSER INTERFACE | 30 |
| SYSTEM..... | 32 |
| PORT | 47 |
| SWITCHING | 53 |
| TRUNKING | 56 |
| STP / RING..... | 58 |
| VLAN..... | 69 |
| QoS..... | 76 |
| SNMP | 79 |
| 802.1X | 84 |
| OTHER PROTOCOLS..... | 88 |
| Command Line Console Management | 97 |
| ADMINISTRATION CONSOLE | 97 |
| <i>Exec Mode (View Mode)</i> | 98 |
| <i>Privileged Exec Mode (Enable Mode)</i> | 102 |
| <i>Configure Mode (Configure Terminal Mode)</i> | 107 |
| USER INTERFACE CONFIGURATION | 111 |
| SYSTEM..... | 113 |
| PORT | 124 |
| SWITCHING | 131 |
| TRUNKING | 136 |
| STP / RING..... | 141 |
| VLAN..... | 157 |
| QoS..... | 163 |
| SNMP | 166 |
| 802.1X | 173 |
| OTHER PROTOCOLS..... | 178 |
| Specifications..... | 196 |
| Appendix A..... | 198 |
| Appendix B..... | 199 |

Product Overview

Industrial Managed Ethernet Switch

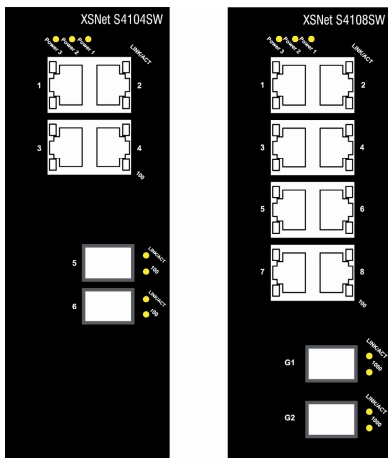

Front View

Package Contents

When you unpack the product package, you shall find the items listed below. Please inspect the contents, and report any apparent damage or missing items immediately to your authorized reseller.

- The Industrial Managed Ethernet Switch
- User's Manual
- RS232 cable

Product Highlights

Basic Features

- Meets EN61000-6-2 & EN61000-6-4 EMC Generic Standard Immunity for industrial environment.
- Manageable via SNMP, Web-based, Telnet, and RS-232 console port.
- Supports Command Line Interface in RS-232 console.
- Supports 802.3/802.3u/802.3ab/802.3z/802.3x. Auto-negotiation: 10/100/1000Mbps, full/half-duplex. Auto MDI/MDIX.
- The S4104SW is equipped with 2x 100Base-FX SFP slots.
- The S4108SW is equipped with 2x 1000Base-FX SFP slots.
- Supports 8192 MAC addresses. Provides 2M bits memory buffer.
- Alarms for power and port link failure by relay output.
- Power Supply: Redundant DC Terminal Block power inputs or 12VDC DC JACK with 100-240VAC external power supply.
- Operating voltage and Max. current consumption: 0.92A @ 12VDC, 0.46A @ 24VDC, 0.23A @ 48VDC. Power consumption: 11W Max.
- -10°C to 60°C (14°F to 140°F) operating temperature range. Tested for functional operation @ -20°C to 70°C (-4°F to 158°F).
- Supports DIN-Rail and Panel Mounting installation.

<Note> Press reset button more than 10 seconds to restart Managed Switch and reset Managed Switch password to factory default (no password required on default setting).

Management Support

VLAN

- Port-based VLAN
- IEEE802.1Q tagged VLAN

TRUNKING

- Port Trunking
- IEEE802.3ad Link Aggregation Control Protocol

PORT-SECURITY

- Per-port programmable MAC address locking
- Up to 24 Static Secure MAC addresses per port
- IEEE802.1x Port-based Network Access Control

PORT-MIRRORING

- Port-mirroring

QOS (IEEE802.1p Quality of Service)

- 4 priority queues

INTERNETWORKING PROTOCOLS

- Bridging:
 - IEEE802.1s Multiple Spanning Tree
 - IEEE802.1w Rapid Spanning Tree
 - IEEE802.1D Spanning Tree compatible
 - IEEE802.1Q – GVRP
 - IEEE802.1p – GMRP
 - Ring
 - Chain
- IP Multicast:
 - IGMP Snooping
- Rate Control
- NTP

NETWORK MANAGEMENT METHODS

- Console port access via RS-232 cable (CLI, Command Line Interface)
- Telnet remote access
- SNMP agent:
 - MIB-2 (RFC1213)
 - Bridge MIB (RFC1493)
 - RMON MIB (RFC2819) – statistics, history, alarm and events
 - VLAN MIB (IEEE802.1Q/RFC2674)
 - Private MIB
- Web browser
- TFTP software-upgrade capability

Front Panel Display

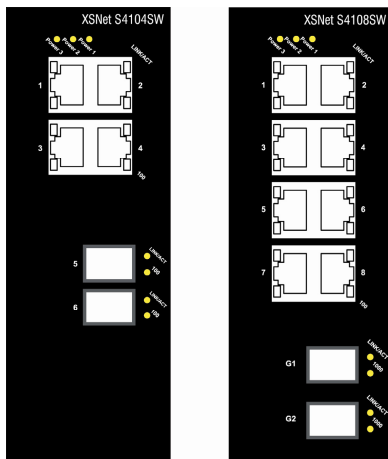

- **POWER**

This LED comes on when the switch is properly connected to power and turned on.

- **Port Status LEDs**

The LEDs are located on the front panel, displaying status for each respective port. Please refer to the following table for more details.

| LED | State | Indication |
|----------------------------|----------|---|
| Power 1 | Steady | Power on |
| Power 2 Power 3 | Off | Power off |
| 10/100Base-TX, 100Base SFP | | |
| LINK/ACT | Steady | A valid network connection established |
| | Flashing | Transmitting or receiving data ACT stands for ACTIVITY |
| 100 | Steady | Connection at 100Mbps speed |
| 1000Base SFP | | |
| LINK/ACT | Steady | A valid network connection established |
| | Flashing | Transmitting or receiving data ACT stands for ACTIVITY |
| 1000 | Steady | Connection at 1000Mbps speed |

Physical Ports

The Industrial Managed Ethernet Switch provides:

| Number of ports | | |
|-----------------|------------------------------|--------------------------|
| 10/100Base-TX | 100Base-FX/BX 100Base SFP | Gigabit: 1000Base SFP |
| 8 | 0 | 2 |
| 4 | 2 | 0 |

CONNECTIVITY

- RJ-45 connectors on TX ports
- Duplex LC connector on SFP 100Base-FX/BX fiber transceiver
- Duplex LC connector on SFP 1000Base-SX/LX/BX fiber transceiver

MODE SELECTION

- 10Base-T full-duplex mode
- 10Base-T half-duplex mode
- 100Base-TX full-duplex mode
- 100Base-TX half-duplex mode
- 100Base-FX full-duplex mode
- 1000Base-SX/LX full-duplex mode
- Auto-negotiating mode

Switch Management

Web-based browser interface

The switch also boasts a point-and-click browser-based interface that lets user access full switch configuration and functionality from a Netscape or Internet Explorer browser.

Administration console via RS-232 serial port (CLI)

The switch provides an onboard serial port, which allows the switch to be configured via a directly connected terminal.

External SNMP-based network management application

The switch can also be configured via SNMP.

Installation

This chapter gives step-by-step instructions about how to install the switch:

Selecting a Site for the Switch

As with any electric device, you should place the switch where it will not be subjected to extreme temperatures, humidity, or electromagnetic interference. Specifically, the site you select should meet the following requirements:

- The ambient temperature should be between -10°C to 60°C (14°F to 140°F).
- The relative humidity should be less than 95 percent, non-condensing.
- Surrounding electrical devices should not exceed the electromagnetic field (RFC) standards.
- Make sure that the switch receives adequate ventilation. Do not block the ventilation holes on each side of the switch.

Connecting to Power

Redundant DC Terminal Block Power Inputs or 12VDC DC Jack:

12VDC DC Jack

Step 1: Connect the supplied AC to DC power adapter to the receptacle on the topside of the switch.

Step 2: Connect the power cord to the AC to DC power adapter and attach the plug into a standard AC outlet with the appropriate AC voltage.

Redundant DC Terminal Block Power Inputs

There are two pairs of power inputs for use with redundant power sources. You only need to have one power input connected to run the switch.

Step 1: Connect the DC power cord to the plug-able terminal block on the switch, and then plug it into a standard DC outlet.

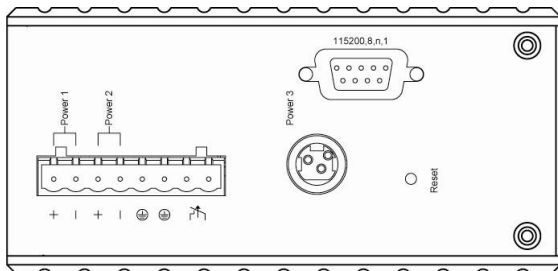

Step 2: Disconnect the power cord if you want to shut down the switch.



Top View

Alarms for Power Failure

Step 1: There are two pins on the terminal block used for power failure detection. It provides the normally closed output when the power source is active. Use this as a dry contact application to send a signal for power failure detection.

| Power Input Assignment | | | |
|---|---|---|----------------|
| Power3 | | 12VDC | DC Jack |
| Power2 | + | 12-48VDC | Terminal Block |
| | - | Power Ground | |
| Power1 | + | 12-48VDC | |
| | - | Power Ground | |
|  | | Earth Ground | |
| Relay Output Rating | | | |
| Relay Alarm Assignment | | | |
|  | | *Warning signal disable for following: The relay contact closes if Power1 and Power2 are both failed but Power3 on. The relay contact closes if Power3 is failed but Power1 and Power2 are both on. | |
| FAULT | | | |

Special note:

The relay output is normal open position when there is no power to the switch. Please do not connect any power source to this terminal to prevent shorting your power supply.

Connecting to Your Network

Cable Type & Length

It is necessary to follow the cable specifications below when connecting the switch to your network. Use appropriate cables that meet your speed and cabling requirements.

Cable Specifications

| Speed | Connector | Port Speed Half/Full Duplex | Cable | Max. Distance |
|--------------|------------------|--|-----------------------------------|--------------------------|
| 10Base-T | RJ-45 | 10/20 Mbps | 2-pair UTP/STP Cat. 3, 4, 5 | 100 m |
| 100Base-TX | RJ-45 | 100/200 Mbps | 2-pair UTP/STP Cat. 5 | 100 m |
| 1000Base-T | RJ-45 | 2000 Mbps | 4-pair UTP/STP Cat. 5 | 100 m |
| SFP | | | | |
| 100Base-FX | Duplex LC | 200 Mbps | MMF (62.5µm) | 2 km |
| 100Base-FX | Duplex LC | 200 Mbps | SMF (10µm) | 20, 40, 75, 100 km |
| 100Base-BX | Duplex LC | 200 Mbps | MMF (62.5µm) | 2, 5 km |
| 100Base-BX | Duplex LC | 200 Mbps | SMF (10µm) | 20, 40 km |
| 1000Base-SX | Duplex LC | 2000 Mbps | MMF (62.5µm) | 550 m 2 km |
| 1000Base-LX | Duplex LC | 2000 Mbps | SMF (9µm) | 10, 40, 60 km |
| 1000Base-BX | Duplex LC | 2000 Mbps | SMF (9µm) | 70 km |

Cabling

Step 1: First, ensure the power of the switch and end devices are turned off.

<Note> Always ensure that the power is off before any installation.

Step 2: Prepare cable with corresponding connectors for each type of port in use.

Step 3: Consult Cable Specifications Table on previous page for cabling requirements based on connectors and speed.

Step 4: Connect one end of the cable to the switch and the other end to a desired device.

Step 5: Once the connections between two end devices are made successfully, turn on the power and the switch is operational.

Switch Management

This chapter explains the methods that you can use to configure management access to the switch. It describes the types of management applications and the communication and management protocols that deliver data between your management device (workstation or personal computer) and the system. It also contains information about port connection options.

This chapter covers the following topics:

- Management Access Overview
- Key Concepts
- Key Guidelines for Implementation
- Web Management Access
- Administration Console Access
- SNMP Access
- Standards, Protocols, and Related Reading

Management Access Overview

The switch gives you the flexibility to access and manage the switch using any or all of the following methods.

The web browser interface and administration console (CLI) support are embedded in the switch software and are available for immediate use.

Administration Console (CLI)

The administration console is an internal, character-oriented, Command Line Interface (CLI) for performing system administration such as displaying statistics or changing option settings.

Using this method, you can view the administration console from a terminal, personal computer, Apple Macintosh, or workstation connected to the switch's console port.

Direct Access

Direct access to the administration console is achieved by directly connecting a terminal or a PC equipped with a terminal-emulation program (such as HyperTerminal) to the switch console port.

When using the management method, configure the terminal-emulation program to use the following parameters (you can change these settings after login):

[DEFAULT PARAMETERS]

- ◆ 115,200bps
- ◆ 8 data bits
- ◆ No parity
- ◆ 1 stop bit

This management method is often preferred because you can remain connected and monitor the system during system reboots. Also, certain error messages are sent to the serial port, regardless of the interface through which the associated action was initiated. A Macintosh or PC attachment can use any terminal-emulation program for connecting to the terminal serial port. A workstation attachment under UNIX can use an emulator such as TIP.

Web Management

The switch provides a browser interface that lets you configure and manage the switch remotely.

After you set up your IP address for the switch, you can access the switch's web interface applications directly in your web browser by entering the IP address of the switch. You can then use your web browser to list and manage switch configuration parameters from one central location, just as if you were directly connected to the switch's console port.

SNMP-Based Network Management

You can use an external SNMP-based application to configure and manage the switch. This management method requires the SNMP agent on the switch and the SNMP Network Management Station to use the same community string. This management method, in fact, uses two community strings: the get community string and the set community string. If the SNMP Network management station only knows the set community string, it can read and write to the MIBs. However, if it only knows the get community string, it can only read MIBs. **The default get and set community strings for the switch are public.**

Protocols

The switch supports the following protocols:

VIRTUAL TERMINAL PROTOCOLS, SUCH AS TELNET

A virtual terminal protocol is a software program, such as Telnet, that allows you to establish a management session from a Macintosh, a PC, or a UNIX workstation. Because Telnet runs over TCP/IP, you must have at least one IP address configured on the switch before you can establish access to it with a virtual terminal protocol.

<Note> Terminal emulation is different from a virtual terminal protocol in that you must connect a terminal directly to the console port.

SIMPLE NETWORK MANAGEMENT PROTOCOL (SNMP)

SNMP is the standard management protocol for multivendor IP networks. SNMP supports transaction-based queries that allow the protocol to format messages and to transmit information between reporting devices and data-collection programs. SNMP runs on top of the User Datagram Protocol (UDP), offering a connectionless-mode service.

Management Architecture

All of the management application modules use the same Messaging Application Programming Interface (MAPI). By unifying management methods with a single MAPI, configuration parameters set using one method (e.g. console port) are immediately displayed the other management methods (e.g. SNMP agent or web browser).

The management architecture of the switch adheres to the IEEE open standard. This compliance assures customers that the switch is compatible with, and will interoperate with other solutions that adhere to the same open standard.

SNMP & RMON Management

This chapter describes the switch's Simple Network Management Protocol (SNMP) and Remote Monitoring (RMON) capabilities.

Overview

RMON is an abbreviation for the Remote Monitoring MIB (Management Information Base). RMON is a system defined by the Internet Engineering Task Force (IETF) document RFC 2819, which defines how networks can be monitored remotely.

RMONs typically consist of two components: an RMON probe and a management workstation:

- The RMON probe is an intelligent device or software agent that continually collects statistics about a LAN segment or VLAN. The RMON probe transfers the collected data to a management workstation on request or when a pre-defined threshold is reached.
- The management workstation collects the statistics that the RMON probe gathers. The workstation can reside on the same network as the probe, or it can have an in-band or out-of-band connection to the probe.

The switch provides RMON capabilities that allow network administrators to set parameters and view statistical counters defined in MIB-II, Bridge MIB, and RMON MIB. RMON activities are performed at a Network Management Station running an SNMP network management application with graphical user interface.

SNMP Agent and MIB-2 (RFC 1213)

The SNMP Agent running on the switch manager CPU is responsible for:

- Retrieving MIB counters from various layers of software modules according to the SNMP GET/GET NEXT frame messages.
- Setting MIB variables according to the SNMP SET frame message.
- Generating an SNMP TRAP frame message to the Network Management Station if the threshold of a certain MIB counter is reached or if other trap conditions (such as the following) are met:

WARM START

COLD START

LINK UP

LINK DOWN

AUTHENTICATION FAILURE

RISING ALARM

FALLING ALARM

TOPOLOGY ALARM

MIB-II defines a set of manageable objects in various layers of the TCP/IP protocol suites. MIB-II covers all manageable objects from layer 1 to layer 4, and, as a result, is the major SNMP MIB supported by all vendors in the networking industry. The switch supports a complete implementation of SNMP Agent and MIB-II.

RMON MIB (RFC 2819) and Bridge MIB (RFC 1493)

The switch provides hardware-based RMON counters in the switch chipset. The switch manager CPU polls these counters periodically to collect the statistics in a format that complies with the RMON MIB definition.

RMON Groups Supported

The switch supports the following RMON MIB groups defined in RFC 2819:

- RMON Statistics Group – maintains utilization and error statistics for the switch port being monitored.
- RMON History Group – gathers and stores periodic statistical samples from the previous Statistics Group.
- RMON Alarm Group – allows a network administrator to define alarm thresholds for any MIB variable. An alarm can be associated with Low Threshold, High Threshold, or both. A trigger can trigger an alarm when the value of a specific MIB variable exceeds a threshold, falls below a threshold, or exceeds or falls below a threshold.
- RMON Event Group – allows a network administrator to define actions based on alarms. SNMP Traps are generated when RMON Alarms are triggered. The action taken in the Network Management Station depends on the specific network management application.

Bridge Groups Supported

The switch supports the following four groups of Bridge MIB (RFC 1493):

- The dot1dBase Group – a mandatory group that contains the objects applicable to all types of bridges.
- The dot1dStp Group – contains objects that denote the bridge's state with respect to the Spanning Tree Protocol. If a node does not implement the Spanning Tree Protocol, this group will not be implemented. This group is applicable to any transparent only, source route, or SRT bridge that implements the Spanning Tree Protocol.
- The dot1dTp Group – contains objects that describe the entity's transparent bridging status. This group is applicable to transparent operation only and SRT bridges.
- The dot1dStatic Group – contains objects that describe the entity's destination-address filtering status. This group is applicable to any type of bridge which performs destination-address filtering.

Web-Based Browser Management

The switch provides a web-based browser interface for configuring and managing the switch. This interface allows you to access the switch using a preferred web browser.

This chapter describes how to configure the switch using its web-based browser interface.

Logging on to the switch

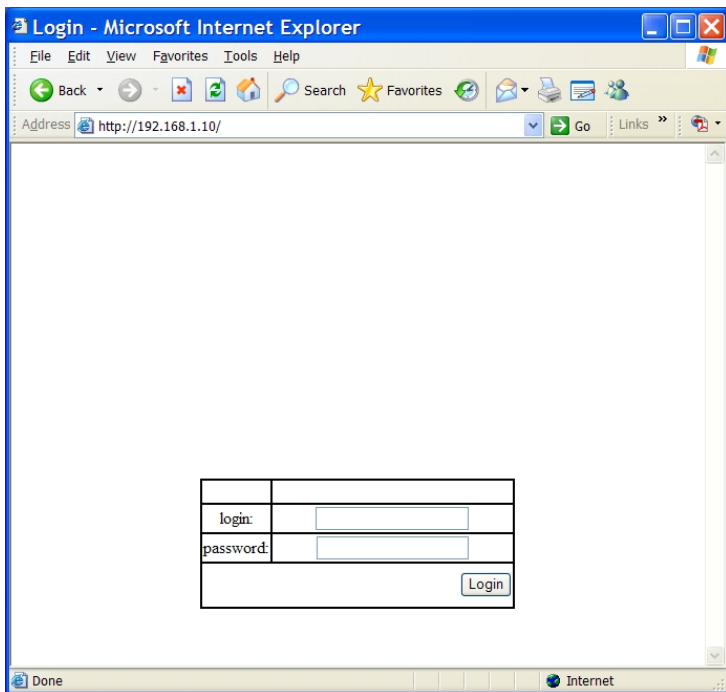

SWITCH IP ADDRESS

In your web browser, specify the IP address of the switch. Default IP address

is 192.168.1.10.

LOGIN

Enter the factory default login ID: root.

PASSWORD

Enter the factory default password (no password).

Or enter a user-defined password if you followed the instructions later and changed the factory default password.

Then click on the “Login” button to log on to the switch.

Understanding the Browser Interface

The web browser interface provides groups of point-and-click buttons at the left field of the screen for configuring and managing the switch.

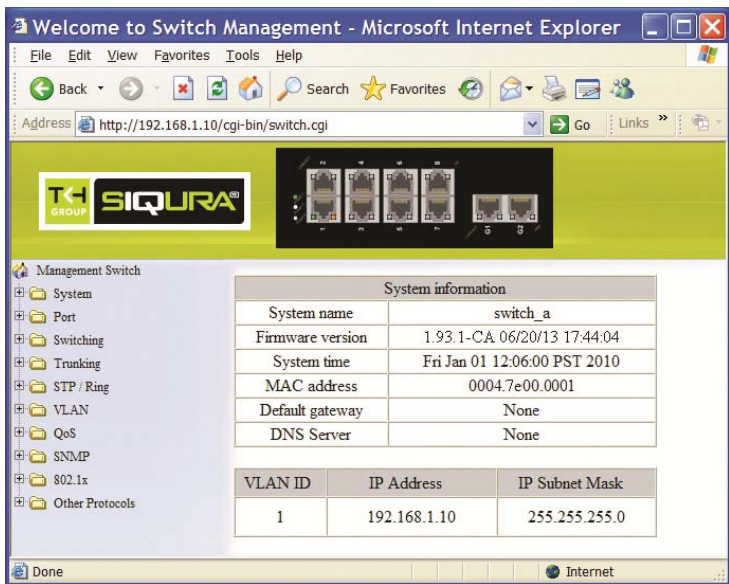

Management Switch

- System
- Port
- Switching
- Trunking
- STP / Ring
- VLAN
- QoS
- SNMP
- 802.1x
- Other Protocols

| System information | |
|--------------------|------------------------------|
| System name | switch_a |
| Firmware version | 1.93.1-CA 06/20/13 17:44:04 |
| System time | Fri Jan 01 12:06:00 PST 2010 |
| MAC address | 0004.7e00.0001 |
| Default gateway | None |
| DNS Server | None |

| VLAN ID | IP Address | IP Subnet Mask |
|---------|--------------|----------------|
| 1 | 192.168.1.10 | 255.255.255.0 |

SYSTEM

System Information, System Name/Password, IP Address, ARP Table, Route Table, Save Configuration, Firmware Upgrade, Alarm Setting, Reboot, Logout

PORT

Configuration, Port Status, Rate Control, RMON Statistics, Per Port Vlan Activities, Port Security

SWITCHING

Bridging, Static MAC Entry, Port Mirroring

TRUNKING

Port Trunking, LACP Trunking

STP / RING

Global Configuration, RSTP Port Setting, MSTP Properties, MSTP Instance Setting, MSTP Port Setting, Ring Setting, Chain Setting

VLAN

VLAN Mode Setting, 802.1Q VLAN Setting, 802.1Q Port Setting, Port Based VLAN

QOS

Global Configuration, 802.1p Priority, DSCP

SNMP

SNMP General Setting, SNMP v1/v2c, SNMP v3

802.1X

Radius Configuration, Port Authentication

OTHER PROTOCOLS

GVRP, IGMP Snooping, NTP, GMRP, DHCP Server

System

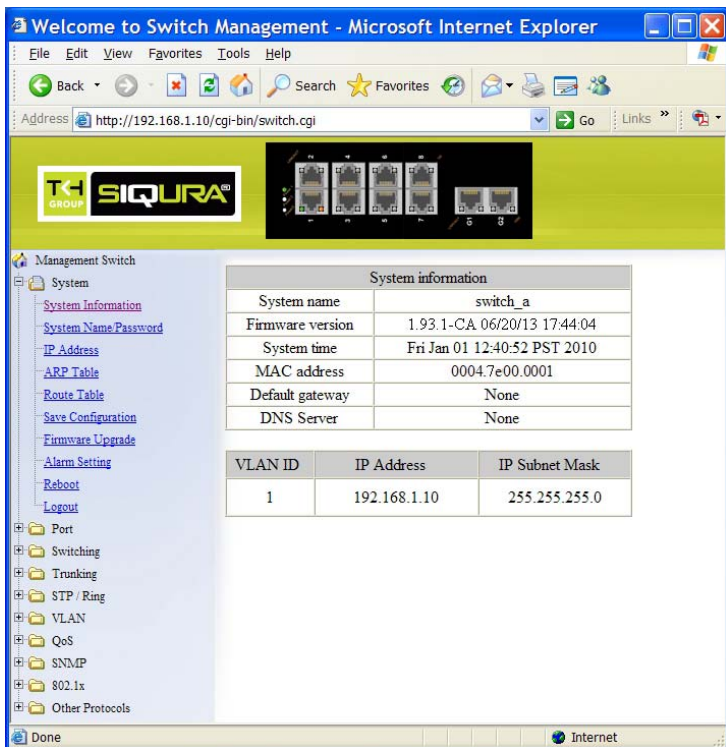

Management Switch

- System
 - System Information
 - System Name/Password
 - IP Address
 - ARP Table
 - Route Table
 - Save Configuration
 - Firmware Upgrade
 - Alarm Setting
 - Reboot
 - Logout
- Port
- Switching
- Trunking
- STP / Ring
- VLAN
- QoS
- SNMP
- 802.1x
- Other Protocols

| System information | |
|--------------------|------------------------------|
| System name | switch_a |
| Firmware version | 1.93.1-CA 06/20/13 17:44:04 |
| System time | Fri Jan 01 12:40:52 PST 2010 |
| MAC address | 0004.7e00.0001 |
| Default gateway | None |
| DNS Server | None |

| VLAN ID | IP Address | IP Subnet Mask |
|---------|--------------|----------------|
| 1 | 192.168.1.10 | 255.255.255.0 |

System Information

View System information, VLAN ID, IP Address, and IP Subnet Mask of the Switch.

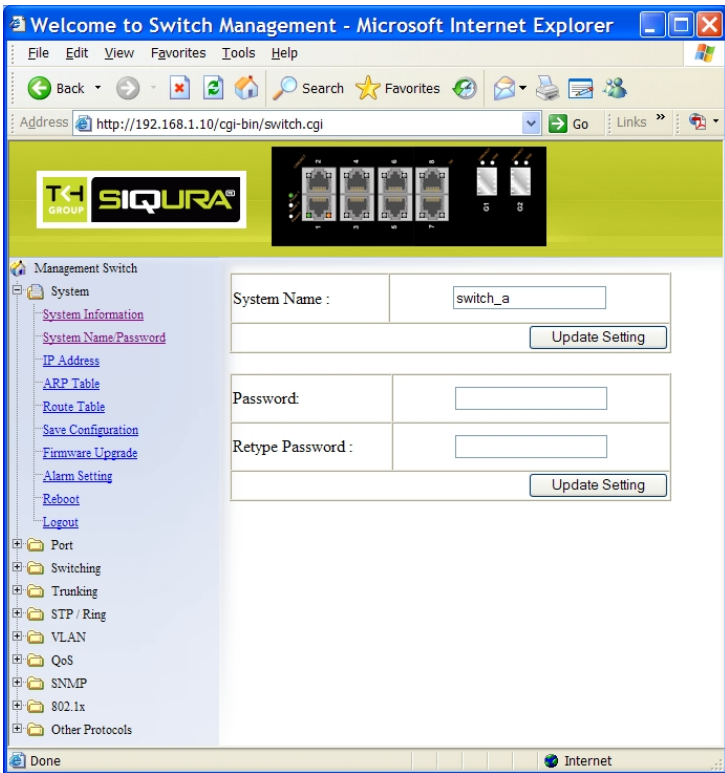

Management Switch

- System
 - System Information
 - System Name/Password
 - IP Address
 - ARP Table
 - Route Table
 - Save Configuration
 - Firmware Upgrade
 - Alarm Setting
 - Reboot
 - Logout
- Port
- Switching
- Trunking
- STP / Ring
- VLAN
- QoS
- SNMP
- 802.1x
- Other Protocols

System Name :

Password:

Retype Password :

System Name/Password

1. System Name: Click in "System Name" text box. Type a system name if it is blank, or replace the current system name with a new one.
2. Update Setting: Click "Update Setting" button to update your settings.
3. Password: Click in "Password" text box. Type a password.
4. Retype Password: Click in "Retype Password" text box. Type the same password in "Password" text box again to verify it.
5. Update Setting: Click "Update Setting" button to update your settings.

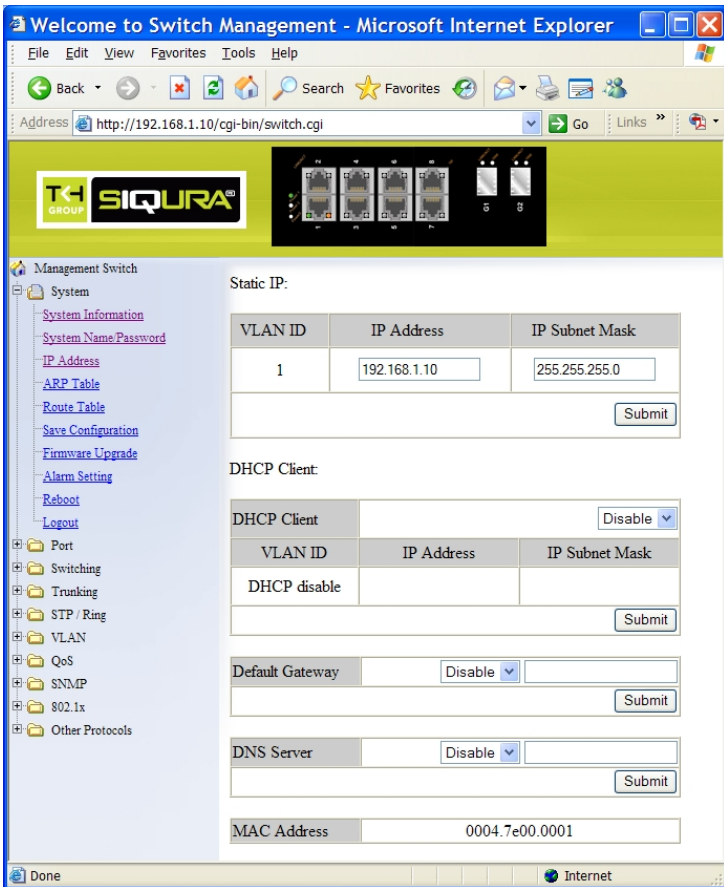

Management Switch

System

- System Information
- System Name/Password
- IP Address
- ARP Table
- Route Table
- Save Configuration
- Firmware Upgrade
- Alarm Setting
- Reboot
- Logout

Port

Switching

Trunking

STP / Ring

VLAN

QoS

SNMP

802.1x

Other Protocols

Static IP:

| VLAN ID | IP Address | IP Subnet Mask |
|---------|--------------|----------------|
| 1 | 192.168.1.10 | 255.255.255.0 |

Submit

DHCP Client:

DHCP Client

| VLAN ID | IP Address | IP Subnet Mask |
|--------------|------------|----------------|
| DHCP disable | | |

Submit

Default Gateway

Submit

DNS Server

Submit

MAC Address 0004.7e00.0001

IP Address

1. IP Address: Click in "IP Address" text box and type a new address to change the IP Address.
2. IP Subnet Mask: Click in "IP Subnet Mask" text box and type a new address to change the IP Subnet Mask.
3. Submit: Click "Submit" button when you finished these selections.
4. You need to enter the new IP address on the browser and reconnect to the switch after IP or subnet mask are changed.
5. DHCP Client: Click "DHCP Client" drop-down menu to choose "Disable" or "VLAN1" (or other VLAN group) from the "DHCP Client" drop-down list to disable or enable DHCP Client Setting for the switch. The

managed VLAN is VLAN 1 by default. The managed IP Address will be assigned by DHCP Server when VLAN 1 is chosen as DHCP Client. DHCP Server can assign the Switch another managed IP Address by choosing another VLAN besides VLAN 1 as DHCP Client when Switch has multiple VLANs.

6. Submit: Click "Submit" button when you finished DHCP Client.
7. Default Gateway: Click "Default Gateway" drop-down menu to choose "Disable" or "Enable" from the "Default Gateway" drop-down list to disable or enable Default Gateway Setting for the switch.
Click the text box and type a new address to change the Default Gateway. (Need to choose "Enable" from the "Default Gateway" drop-down menu.)
8. Submit: Click "Submit" button when you finished Default Gateway.
9. DNS Server: Click "DNS Server" drop-down menu to choose "Disable" or "Enable" from the "DNS Server" drop-down list to disable or enable DNS Server Setting for the switch.
Click the text box and type a new address to change the DNS Server. (Need to choose "Enable" from the "DNS Server" drop-down menu.)
10. Submit: Click "Submit" button when you finished DNS Server.

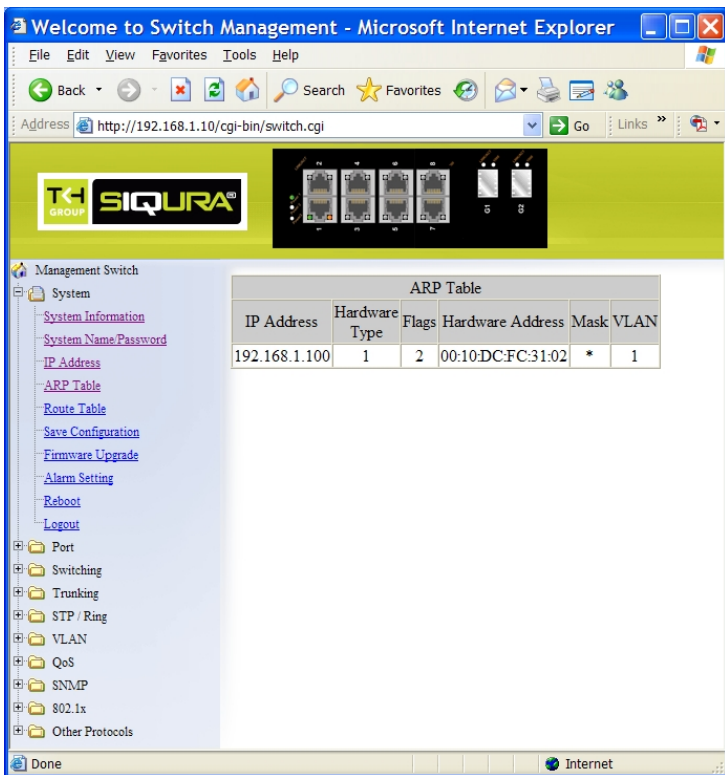

Management Switch

- System
 - System Information
 - System Name/Password
 - IP Address
 - ARP Table
 - Route Table
 - Save Configuration
 - Firmware Upgrade
 - Alarm Setting
 - Reboot
 - Logout
- Port
- Switching
- Trunking
- STP / Ring
- VLAN
- QoS
- SNMP
- 802.1x
- Other Protocols

| ARP Table | | | | | |
|---------------|---------------|-------|-------------------|------|------|
| IP Address | Hardware Type | Flags | Hardware Address | Mask | VLAN |
| 192.168.1.100 | 1 | 2 | 00:10:DC:FC:31:02 | * | 1 |

ARP Table

Click **ARP Table** to view ARP Table.

The ARP Table is learned by Switch CPU, not learned by Switch MAC. The MAC Address of PC that have accessed Switch user interface will be recorded in the ARP Table.



Management Switch

- System
 - System Information
 - System Name/Password
 - IP Address
 - ARP Table
 - Route Table
 - Save Configuration
 - Firmware Upgrade
 - Alarm Setting
 - Reboot
 - Logout
- Port
- Switching
- Trunking
- STP / Ring
- VLAN
- QoS
- SNMP
- 802.1x
- Other Protocols

| Route Table | | | | | | |
|-------------|---------|---------------|-------|--------|---------|------|
| Destination | Gateway | Genmask | Flags | Metric | Ref Use | VLAN |
| 192.168.1.0 | 0.0.0.0 | 255.255.255.0 | U | 0 | 0 0 | 1 |

Route Table

Click **Route Table** to view Route Table.

Route Table lists the routes to network destinations. And metrics (distances) are associated with those routes. The Route Table contains information about the topology of the network around it.

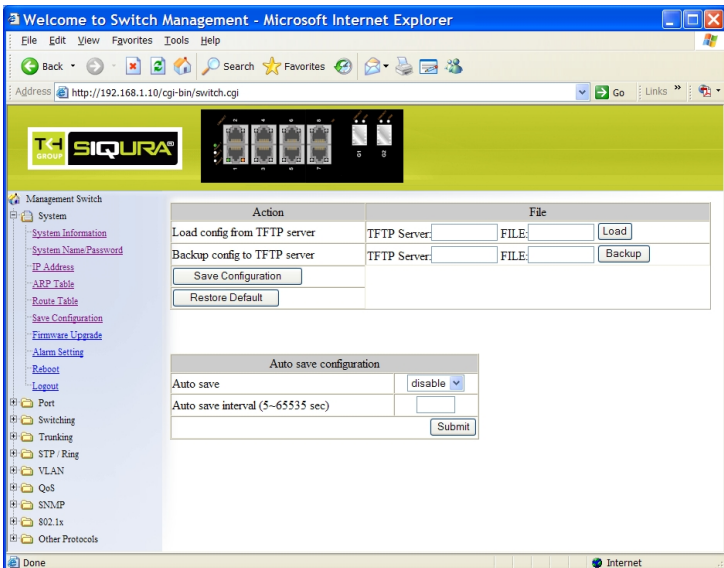

Save Configuration

- Load config from TFTP server:**
 Click in "TFTP Server" text box and type the TFTP server IP address from where the file will be obtained.
 Click in "FILE" text box and type the name of the file that will be obtained.
 Click "Load" button to load the file from the TFTP server.
- Backup config to TFTP server:**
 Click in "TFTP Server" text box and type the TFTP server IP address to where the file will be backedup.
 Click in "FILE" text box and type the name of the file that will be backedup.
 Click "Backup" button to backup the file to the TFTP server.
- Save Configuration:** Click "Save Configuration" button to save your configuration settings.
- Restore Default:** Click "Restore Default" button to restore the default settings of the switch.
- Auto save:** Click "Auto save" drop-down menu to choose "Disable" or "Enable" from the "Auto save" drop-down list to disable or enable Auto save for the switch.
- Auto save interval (5~65536 sec):** Click in "Auto save interval" text box and type a decimal number between 5 and 65536.
- Submit:** Click "Submit" button when you finished Auto save configuration.

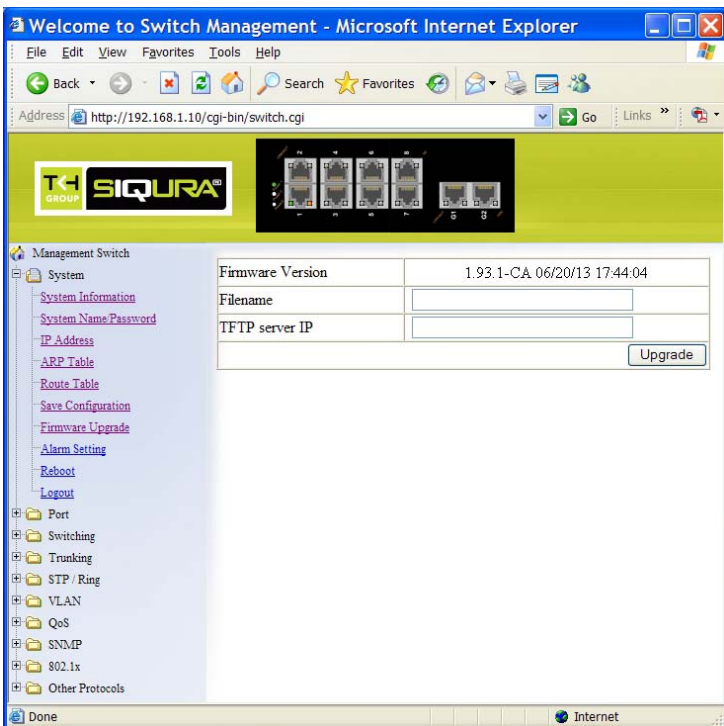

Firmware Upgrade

1. **Filename:** Click in "Filename" text box and type the name of the file that you intend to upgrade it to the switch.
2. **TFTP server IP:** Click in "TFTP server IP" text box and type the TFTP server IP address from where the file will be obtained.
3. **Upgrade:** Click "Upgrade" button to upgrade firmware to the switch. Please follow the message on the screen during the firmware upgrade process. Do not turn off the power or perform other functions during this period of time. Reboot the switch after completing the upgrade process.

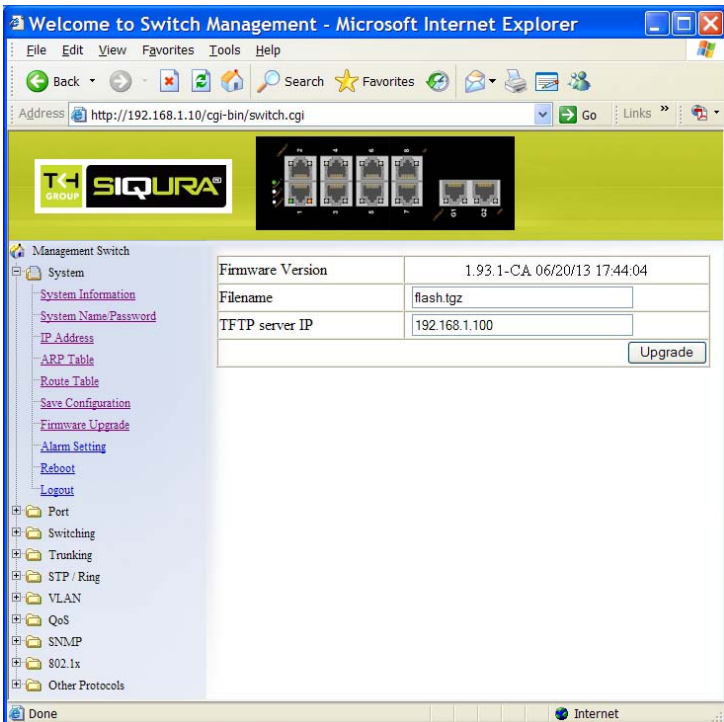

Management Switch

- System
 - System Information
 - System Name/Password
 - IP Address
 - ARP Table
 - Route Table
 - Save Configuration
 - Firmware Upgrade
 - Alarm Setting
 - Reboot
 - Logout
- Port
- Switching
- Trunking
- STP / Ring
- VLAN
- QoS
- SNMP
- 802.1x
- Other Protocols

| | |
|--|--|
| Firmware Version | 1.93.1-CA 06/20/13 17:44:04 |
| Filename | <input type="text" value="flash.tgz"/> |
| TFTP server IP | <input type="text" value="192.168.1.100"/> |
| <input type="button" value="Upgrade"/> | |

Please follow the message on the screen during the firmware upgrade process. Do not turn off the power or perform other functions during this period of time.

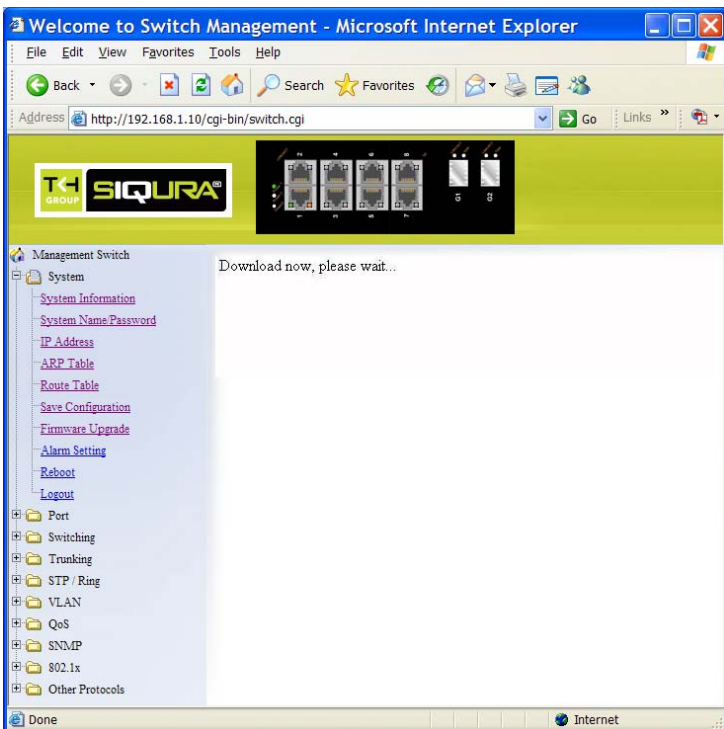

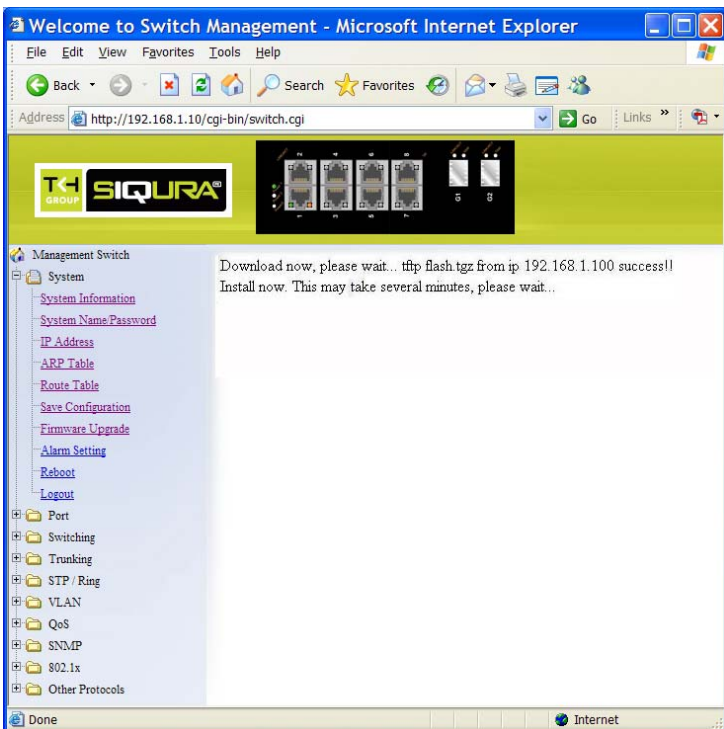

Firmware has been upgraded successfully to the switch. Reboot the switch after completing the upgrade process.

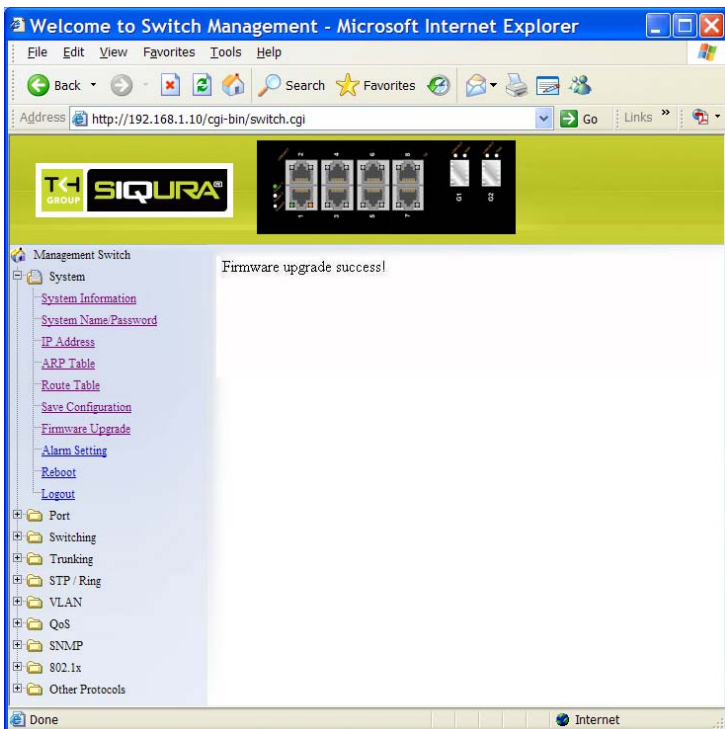

Welcome to Switch Management - Microsoft Internet Explorer

Address: http://192.168.1.10/cgi-bin/switch.cgi

Management Switch

System

- System Information
- System Name/Password
- IP Address
- ARP Table
- Route Table
- Save Configuration
- Firmware Upgrade
- Alarm Setting
- Reboot
- Logout

Port

Switching

Trunking

STP / Ring

VLAN

QoS

SNMP

802.1x

Other Protocols

Firmware upgrade success!

Done Internet

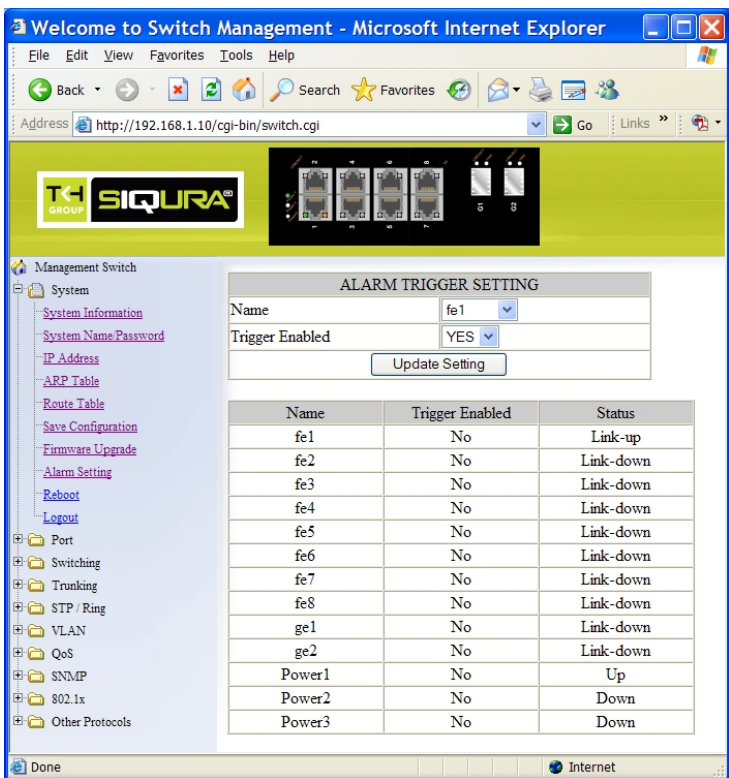

ALARM TRIGGER SETTING

Name: fe1
 Trigger Enabled: YES
 Update Setting

| Name | Trigger Enabled | Status |
|--------|-----------------|-----------|
| fe1 | No | Link-up |
| fe2 | No | Link-down |
| fe3 | No | Link-down |
| fe4 | No | Link-down |
| fe5 | No | Link-down |
| fe6 | No | Link-down |
| fe7 | No | Link-down |
| fe8 | No | Link-down |
| ge1 | No | Link-down |
| ge2 | No | Link-down |
| Power1 | No | Up |
| Power2 | No | Down |
| Power3 | No | Down |

Alarm Setting

1. Name: Click "Name" drop-down menu to choose "fe1~fe8", "ge1~ge2", or "Power1~Power3" from the "Name" drop-down list.
2. Trigger Enabled: Click "Trigger Enabled" drop-down menu to choose "YES" or "NO" from the "Trigger Enabled" drop-down list to enable or disable Trigger.
3. Update Setting: Click "Update Setting" button to update settings to the switch.

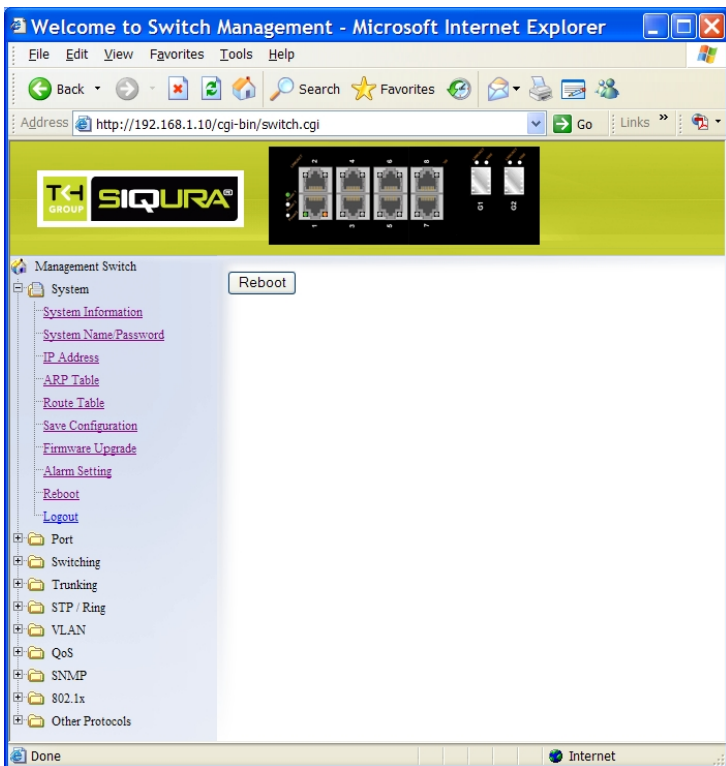

Reboot

Reboot: Click “Reboot” button to restart the switch.

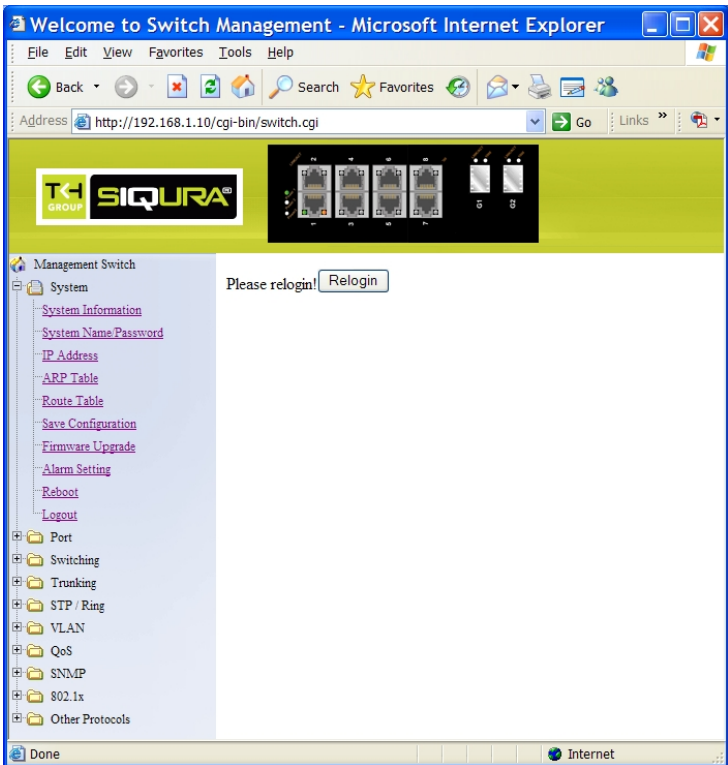

Logout

Logout: Click “Logout” button to logout of the switch.

Port

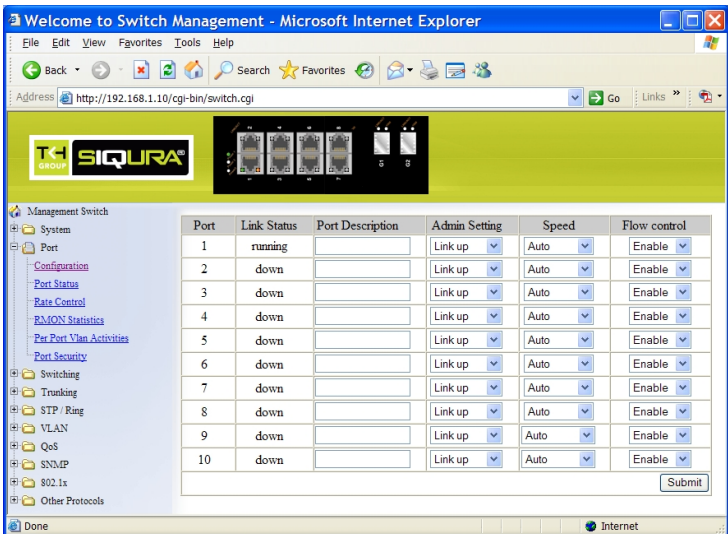

| Port | Link Status | Port Description | Admin Setting | Speed | Flow control |
|------|-------------|------------------|---------------|-------|--------------|
| 1 | running | | Link up | Auto | Enable |
| 2 | down | | Link up | Auto | Enable |
| 3 | down | | Link up | Auto | Enable |
| 4 | down | | Link up | Auto | Enable |
| 5 | down | | Link up | Auto | Enable |
| 6 | down | | Link up | Auto | Enable |
| 7 | down | | Link up | Auto | Enable |
| 8 | down | | Link up | Auto | Enable |
| 9 | down | | Link up | Auto | Enable |
| 10 | down | | Link up | Auto | Enable |

Configuration

1. Port Description: Click in "Port Description" text box and type description for port.
2. Admin Setting: Click "Admin Setting" drop-down menu to choose "Link down" or "Link up" from the "Admin Setting" drop-down list to disable or enable Admin Setting for the port.
3. Speed: Click "Speed" drop-down menu to change the line speed and duplex settings from the "Speed" drop-down list for the port.
4. Flow control: Click "Flow control" drop-down menu to choose "Disable" or "Enable" from the "Flow control" drop-down list to disable or enable Flow control for the port.
5. Submit: Click "Submit" button when you finished configurations.

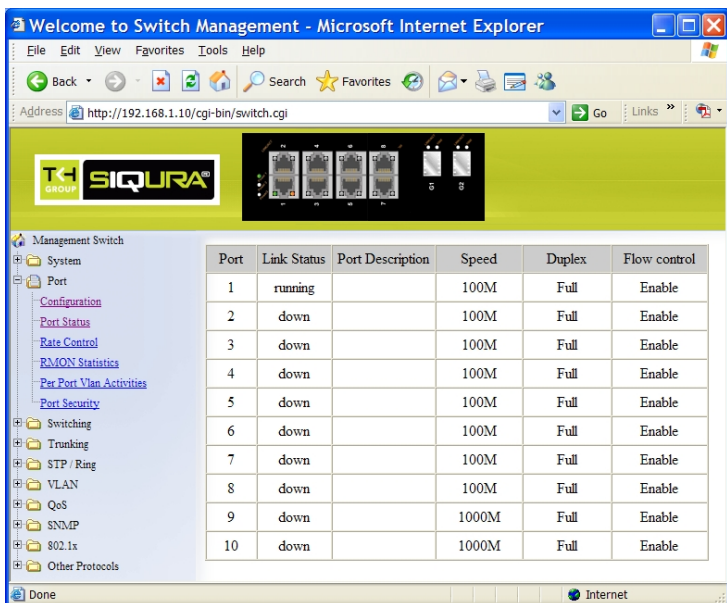

Management Switch

- System
- Port
 - [Configuration](#)
 - [Port Status](#)
 - [Rate Control](#)
 - [RMON Statistics](#)
 - [Per Port Vlan Activities](#)
 - [Port Security](#)
- Switching
- Trunking
- STP / Ring
- VLAN
- QoS
- SNMP
- 802.1x
- Other Protocols

| Port | Link Status | Port Description | Speed | Duplex | Flow control |
|------|-------------|------------------|-------|--------|--------------|
| 1 | running | | 100M | Full | Enable |
| 2 | down | | 100M | Full | Enable |
| 3 | down | | 100M | Full | Enable |
| 4 | down | | 100M | Full | Enable |
| 5 | down | | 100M | Full | Enable |
| 6 | down | | 100M | Full | Enable |
| 7 | down | | 100M | Full | Enable |
| 8 | down | | 100M | Full | Enable |
| 9 | down | | 1000M | Full | Enable |
| 10 | down | | 1000M | Full | Enable |

Port Status

View the Link Status, Port Description, Speed, Duplex, and Flow control status for all ports.

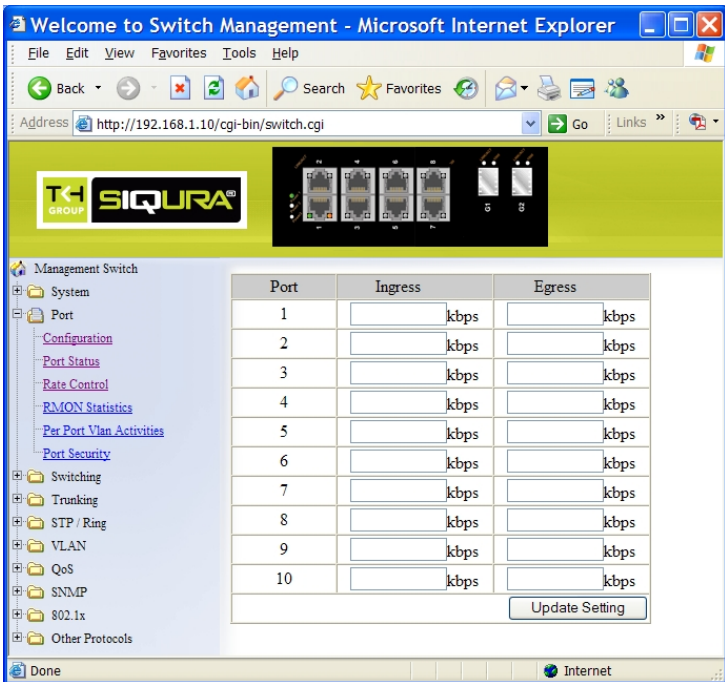

| Port | Ingress | Egress |
|------|---------------------------|---------------------------|
| 1 | <input type="text"/> kbps | <input type="text"/> kbps |
| 2 | <input type="text"/> kbps | <input type="text"/> kbps |
| 3 | <input type="text"/> kbps | <input type="text"/> kbps |
| 4 | <input type="text"/> kbps | <input type="text"/> kbps |
| 5 | <input type="text"/> kbps | <input type="text"/> kbps |
| 6 | <input type="text"/> kbps | <input type="text"/> kbps |
| 7 | <input type="text"/> kbps | <input type="text"/> kbps |
| 8 | <input type="text"/> kbps | <input type="text"/> kbps |
| 9 | <input type="text"/> kbps | <input type="text"/> kbps |
| 10 | <input type="text"/> kbps | <input type="text"/> kbps |

Rate Control

1. Ingress: Click in "Ingress" text box and type a new Rate to change the Ingress Rate Control for the port.
Rate Values: 64kbps, 128kbps, 192kbps, ... , 1792kbps.
2Mbps, 3Mbps, 4Mbps, ... , 100Mbps.
104Mbps, 112Mbps, 120Mbps, ... , 1000Mbps.
<Note>: M = 1024k.
2. Egress: Click in "Egress" text box and type a new Rate to change the Egress Rate Control for the port.
Rate Values: 64kbps, 128kbps, 192kbps, ... , 1792kbps.
2Mbps, 3Mbps, 4Mbps, ... , 100Mbps.
104Mbps, 112Mbps, 120Mbps, ... , 1000Mbps.
<Note>: M = 1024k.
3. Update Setting: Click "Update Setting" button when you finished these Rate Control settings.

Welcome to Switch Management - Microsoft Internet Explorer

Address: <http://192.168.1.10/cgi-bin/switch.cgi>



Management Switch

- System
- Port
 - [Configuration](#)
 - [Port Status](#)
 - [Rate Control](#)
 - [RMON Statistics](#)
 - [Per Port Vlan Activities](#)
 - [Port Security](#)
- Switching
- Trunking
- STP / Ring
- VLAN
- QoS
- SNMP
- 802.1x
- Other Protocols

| | | | | |
|-----------------------|-----------------------|-----------------------|-----------------------|------------------------|
| Port1 | Port2 | Port3 | Port4 | Port5 |
| Port6 | Port7 | Port8 | Port9 | Port10 |

Port 1 Statistics

| | |
|-----------------------------------|--------|
| Drop Events | 0 |
| Broadcast Packets Received | 166 |
| Multicast Packets Received | 5 |
| Undersize Packets Received | 0 |
| Oversize Packets Received | 0 |
| fragments_pkts | 0 |
| 64-byte Packets Received | 3498 |
| 65 to 127-byte Packets Received | 1013 |
| 128 to 255-byte Packets Received | 25 |
| 256 to 511-byte Packets Received | 1614 |
| 512 to 1023-byte Packets Received | 5 |
| 1.0 to 1.5-kbyte Packets Received | 0 |
| Jabber Packets | 0 |
| Bytes Received | 985710 |
| Packets Received | 6155 |
| Collisions | 0 |
| CRC/Alignment Errors Received | 0 |
| TX No Errors | 7389 |
| RX No Errors | 6155 |

Done Internet

RMON Statistics

Click ports to view corresponding RMON Statistics.

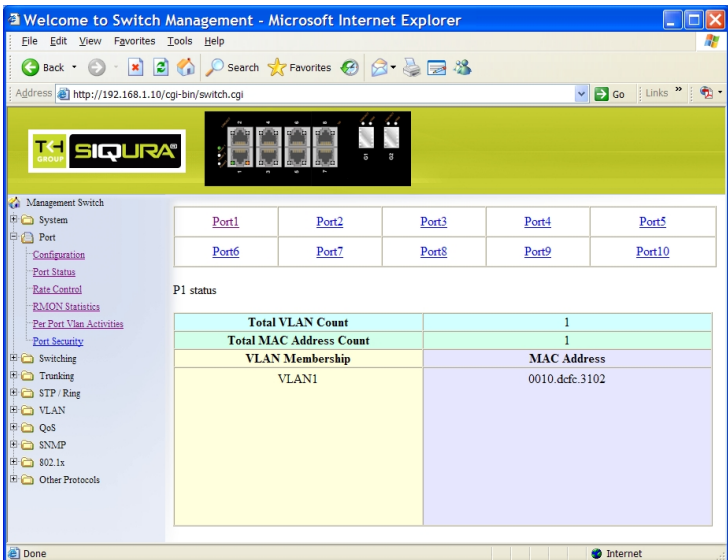

Management Switch

- System
- Port
 - Configuration
 - Port Status
 - Rate Control
 - RMON Statistics
 - Per Port Vlan Activities
 - Port Security
- Switching
 - Trunking
 - STP / Ring
 - VLAN
 - QoS
 - SNMP
 - 802.1x
 - Other Protocols

| | | | | |
|-----------------------|-----------------------|-----------------------|-----------------------|------------------------|
| Port1 | Port2 | Port3 | Port4 | Port5 |
| Port6 | Port7 | Port8 | Port9 | Port10 |

P1 status

| | |
|--------------------------------|--------------------|
| Total VLAN Count | 1 |
| Total MAC Address Count | 1 |
| VLAN Membership | MAC Address |
| VLAN1 | 0010.dcf:3102 |

Per Port Vlan Activities

Click ports to view corresponding vlan activities.

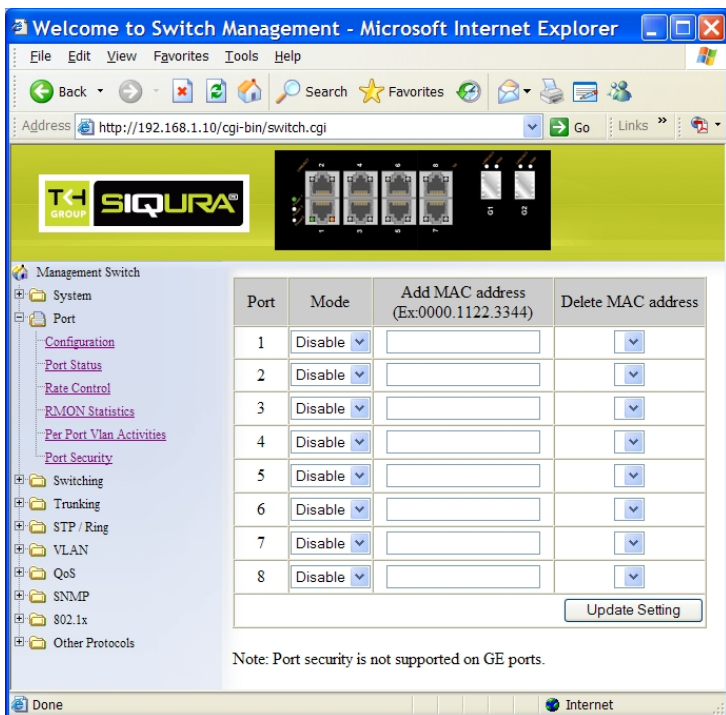

| Port | Mode | Add MAC address (Ex:0000.1122.3344) | Delete MAC address |
|------|---------|--|----------------------------------|
| 1 | Disable | <input type="text"/> | <input type="button" value="v"/> |
| 2 | Disable | <input type="text"/> | <input type="button" value="v"/> |
| 3 | Disable | <input type="text"/> | <input type="button" value="v"/> |
| 4 | Disable | <input type="text"/> | <input type="button" value="v"/> |
| 5 | Disable | <input type="text"/> | <input type="button" value="v"/> |
| 6 | Disable | <input type="text"/> | <input type="button" value="v"/> |
| 7 | Disable | <input type="text"/> | <input type="button" value="v"/> |
| 8 | Disable | <input type="text"/> | <input type="button" value="v"/> |

Note: Port security is not supported on GE ports.

Port Security

1. Mode: Click "Mode" drop-down menu to choose "Enable" or "Disable" from "Mode" drop-down list to enable or disable port security.
2. Add MAC address: Click in "Add MAC address" text box and type the MAC address allowed for the port.
3. Delete MAC address: Click "Delete MAC address" drop-down menu and choose the allowed MAC address from the "Delete MAC address" drop-down list to be deleted from the port.
4. Update Setting: Click "Update Setting" button when you finished Port Security settings.

Switching

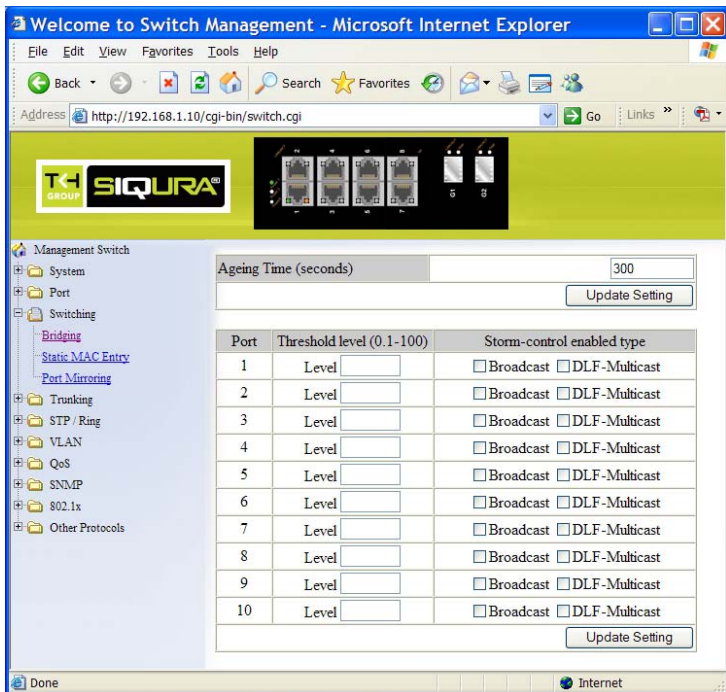

Ageing Time (seconds)

| Port | Threshold level (0.1-100) | Storm-control enabled type |
|------|----------------------------|---|
| 1 | Level <input type="text"/> | <input type="checkbox"/> Broadcast <input type="checkbox"/> DLF-Multicast |
| 2 | Level <input type="text"/> | <input type="checkbox"/> Broadcast <input type="checkbox"/> DLF-Multicast |
| 3 | Level <input type="text"/> | <input type="checkbox"/> Broadcast <input type="checkbox"/> DLF-Multicast |
| 4 | Level <input type="text"/> | <input type="checkbox"/> Broadcast <input type="checkbox"/> DLF-Multicast |
| 5 | Level <input type="text"/> | <input type="checkbox"/> Broadcast <input type="checkbox"/> DLF-Multicast |
| 6 | Level <input type="text"/> | <input type="checkbox"/> Broadcast <input type="checkbox"/> DLF-Multicast |
| 7 | Level <input type="text"/> | <input type="checkbox"/> Broadcast <input type="checkbox"/> DLF-Multicast |
| 8 | Level <input type="text"/> | <input type="checkbox"/> Broadcast <input type="checkbox"/> DLF-Multicast |
| 9 | Level <input type="text"/> | <input type="checkbox"/> Broadcast <input type="checkbox"/> DLF-Multicast |
| 10 | Level <input type="text"/> | <input type="checkbox"/> Broadcast <input type="checkbox"/> DLF-Multicast |

Bridging

1. Aging Time (seconds): Click the text box and type a decimal number as Bridging Aging Time in seconds.
2. Update Setting: Click "Update Setting" button when you finished Aging Time settings.
3. Threshold level (0-100): Click in "Level" text box and type a decimal number for the port. Need to choose "Broadcast" and/or "DLF-Multicast" from "Storm-control enabled type" for the port. DLF (Destination Lookup Failure).
4. Storm-control enabled type: Choose "Broadcast" and/or "DLF-Multicast" from "Storm-control enabled type" for the port.
5. Update Setting: Click "Update Setting" button when you finished Threshold level and Storm-control enabled type settings.

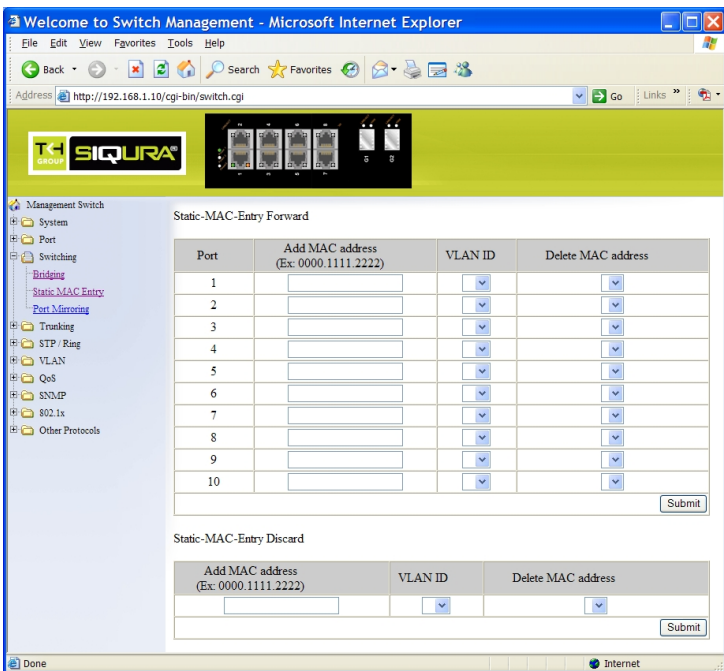

Static MAC Entry

Static-MAC-Entry Forward:

1. Add MAC address: Click in "Add MAC address" text box and type a locked forwarding MAC address for the port.
2. VLAN ID: Click "VLAN ID" drop-down menu and choose a VLAN ID from the "VLAN ID" drop-down list.
3. Delete MAC address: Click "Delete MAC address" drop-down menu and choose a locked forwarding MAC address from the "Delete MAC address" drop-down list to be deleted from the port.
4. Submit: Click "Submit" button when you finished Static-MAC-Entry Forward settings.

Static-MAC-Entry Discard:

1. Add MAC address: Click in "Add MAC address" text box and type a MAC address to be discarded for the VLAN.
2. VLAN ID: VLAN ID: Click "VLAN ID" drop-down menu and choose a VLAN ID from the "VLAN ID" drop-down list.
3. Delete MAC address: Click "Delete MAC address" drop-down menu and choose a MAC address from the "Delete MAC address" drop-down list to be discarded from the VLAN.

- Submit: Click “Submit” button when you finished Static-MAC-Entry Discard settings.

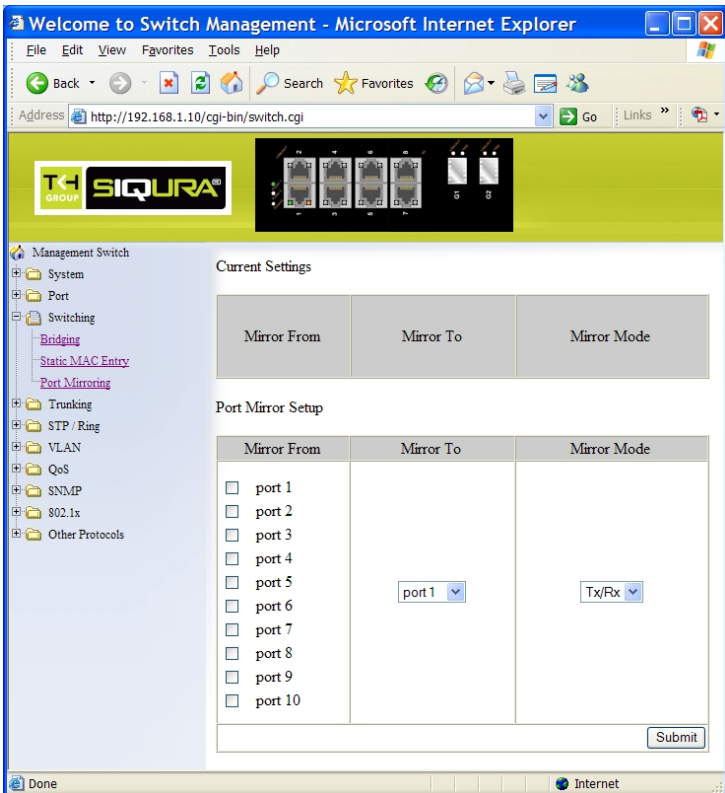

Management Switch

- System
- Port
- Switching
 - Bridging
 - Static MAC Entry**
 - Port Mirroring
- Trunking
- STP / Ring
- VLAN
- QoS
- SNMP
- 802.1x
- Other Protocols

Current Settings

| Mirror From | Mirror To | Mirror Mode |
|-------------|-----------|-------------|
| | | |

Port Mirror Setup

| Mirror From | Mirror To | Mirror Mode |
|----------------------------------|-----------|-------------|
| <input type="checkbox"/> port 1 | | |
| <input type="checkbox"/> port 2 | | |
| <input type="checkbox"/> port 3 | | |
| <input type="checkbox"/> port 4 | | |
| <input type="checkbox"/> port 5 | | |
| <input type="checkbox"/> port 6 | port 1 | Tx/Rx |
| <input type="checkbox"/> port 7 | | |
| <input type="checkbox"/> port 8 | | |
| <input type="checkbox"/> port 9 | | |
| <input type="checkbox"/> port 10 | | |

Submit

Port Mirroring

- Mirror From: Choose Mirror From port from Port 1 ~ Port 10.
- Mirror To: Click “Mirror To” drop-down menu to Choose Mirror To port (Port 1 ~ Port 10) from “Mirror To” drop-down list.
- Mirror Mode: Click “Mirror Mode” drop-down menu to Choose “Tx/Rx”, “Tx”, or “Rx” from “Mirror Mode” drop-down list.
- Submit: Click “Submit” button when you finished Port Mirroring settings.

Trunking

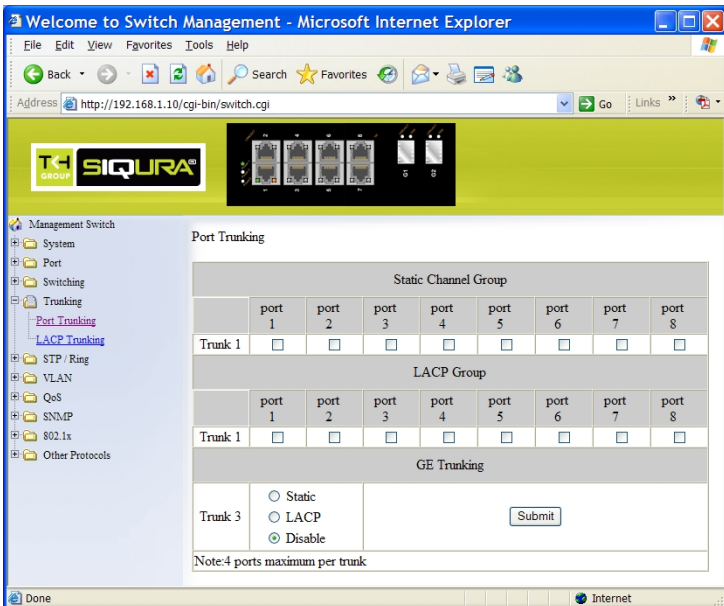

The screenshot shows a web browser window titled "Welcome to Switch Management - Microsoft Internet Explorer". The address bar shows "http://192.168.1.10/cgi-bin/switch.cgi". The page content includes a navigation tree on the left with "Port Trunking" selected. The main area is titled "Port Trunking" and contains three sections: "Static Channel Group", "LACP Group", and "GE Trunking".

Static Channel Group

| | port 1 | port 2 | port 3 | port 4 | port 5 | port 6 | port 7 | port 8 |
|---------|--------------------------|--------------------------|--------------------------|--------------------------|--------------------------|--------------------------|--------------------------|--------------------------|
| Trunk 1 | <input type="checkbox"/> | <input type="checkbox"/> | <input type="checkbox"/> | <input type="checkbox"/> | <input type="checkbox"/> | <input type="checkbox"/> | <input type="checkbox"/> | <input type="checkbox"/> |

LACP Group

| | port 1 | port 2 | port 3 | port 4 | port 5 | port 6 | port 7 | port 8 |
|---------|--------------------------|--------------------------|--------------------------|--------------------------|--------------------------|--------------------------|--------------------------|--------------------------|
| Trunk 1 | <input type="checkbox"/> | <input type="checkbox"/> | <input type="checkbox"/> | <input type="checkbox"/> | <input type="checkbox"/> | <input type="checkbox"/> | <input type="checkbox"/> | <input type="checkbox"/> |

GE Trunking

Trunk 3

Static
 LACP
 Disable

Submit

Note: 4 ports maximum per trunk

Port Trunking

Static Channel Group:

1. Trunk 1: Click Port 1 ~ Port 8 to assign ports to Trunk 1. (Maximum 4 ports in Trunk 1.)

LACP Group:

1. Trunk 1: Click Port 1 ~ Port 8 to assign ports to Trunk 1. (Maximum 4 ports in Trunk 1.)

GE Trunking (Gigabit Ports):

1. Trunk 3: Click "Static", "LACP", or "Disable" for Trunk 3.

Submit: Click "Submit" button when you finished Port Trunking settings.

Welcome to Switch Management - Microsoft Internet Explorer

Address: http://192.168.1.10/cgi-bin/switch.cgi

Management Switch

- System
- Port
- Switching
- Trunking
 - Port Trunking
 - LACP Trunking
- STP Ring
- VLAN
- QoS
- SNMP
- 802.1x
- Other Protocols

Port Status :

| Port | Trunk Type | Admin Key | LACP Mode | LACP Port Priority | LACP Timeout | LACP Sync | LACP Sync Port |
|------|------------|-----------|-----------|--------------------|--------------|-----------|----------------|
| 1 | None | None | None | None | None | None | None |
| 2 | None | None | None | None | None | None | None |
| 3 | None | None | None | None | None | None | None |
| 4 | None | None | None | None | None | None | None |
| 5 | None | None | None | None | None | None | None |
| 6 | None | None | None | None | None | None | None |
| 7 | None | None | None | None | None | None | None |
| 8 | None | None | None | None | None | None | None |
| 9 | None | None | None | None | None | None | None |
| 10 | None | None | None | None | None | None | None |

Trunk Configuration :

| Port | Trunk Type | Admin Key (FE ports:1) (GE ports:3) | LACP Mode | LACP Port Priority (Set 0 for None) | LACP Timeout |
|------|------------|---|-----------|--|--------------|
| 1 | None | <input type="text"/> | Active | <input type="text"/> | Long |

Note: 4 ports maximum per trunk

LACP System Priority
(1-65535, default 32768)

LACP Trunking

Trunk Configuration:

1. Port: Click "Port" drop-down menu to choose port from "Port" drop-down list.
2. Trunk Type: Click "Trunk Type" drop-down menu to choose "None", "Static", or "LACP" from "Trunk Type" drop-down list to disable or enable Static or LACP Trunk.
3. Admin Key: Click in "Admin Key" text box and type a decimal number 1 for FE ports. Type a decimal number 3 for GE ports.
4. LACP Mode: Click "LACP Mode" drop-down menu to choose "Active" or "Passive" from "LACP Mode" drop-down list to enable Active or Passive LACP Mode.
5. LACP Port Priority (Set 0 for None): Click in "LACP Port Priority" text box and type 1-65535 for port. Default value is 32768.
6. LACP Timeout: Click "LACP Timeout" drop-down menu to choose "Long" or "Short" from "LACP Timeout" drop-down list to enable Long or Short LACP Timeout. Long timeout value is 90 seconds. Short timeout value is 3 seconds.
7. Update Setting: Click "Update Setting" button when you finished Trunk Configuration.
8. LACP System Priority (1-65535, default 32768): Click in "LACP System Priority" text box and type 1-65535. Default value is 32768.
9. Submit: Click "Submit" button when you finished LACP System Priority settings.

STP / Ring

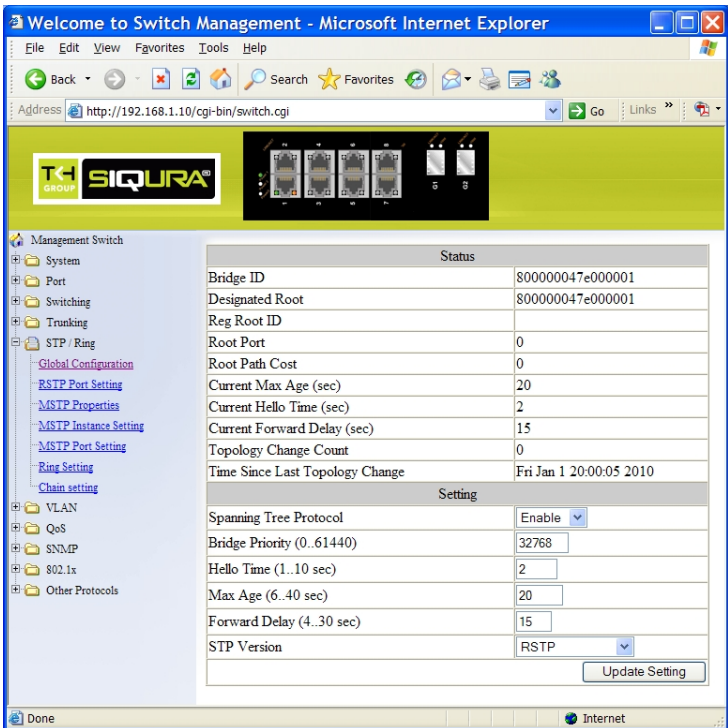

| Status | |
|---------------------------------|-------------------------|
| Bridge ID | 800000047e000001 |
| Designated Root | 800000047e000001 |
| Reg Root ID | |
| Root Port | 0 |
| Root Path Cost | 0 |
| Current Max Age (sec) | 20 |
| Current Hello Time (sec) | 2 |
| Current Forward Delay (sec) | 15 |
| Topology Change Count | 0 |
| Time Since Last Topology Change | Fri Jan 1 20:00:05 2010 |

| Setting | |
|----------------------------|--------|
| Spanning Tree Protocol | Enable |
| Bridge Priority (0..61440) | 32768 |
| Hello Time (1..10 sec) | 2 |
| Max Age (6..40 sec) | 20 |
| Forward Delay (4..30 sec) | 15 |
| STP Version | RSTP |

Update Setting

Global Configuration

- Spanning Tree Protocol: Click "Spanning Tree Protocol" drop-down menu to choose "Enable" or "Disable" from "Spanning Tree Protocol" drop-down list to enable or disable Spanning Tree Protocol.
- Bridge Priority (0..61440): Click in "Bridge Priority" text box and type a decimal number between 0 and 61440.
- Hello Time (sec) (1..9): Click in "Hello Time" text box and type a decimal number between 1 and 9.
- Max Age (sec) (6..28): Click in "Max Age" text box and type a decimal number between 6 and 28.
- Forward Delay (sec) (4..30): Click in "Forward Delay" text box and type a decimal number between 4 and 30.
- STP Version: Click "STP Version" drop-down menu to choose "MSTP", "RSTP", or "STP compatible" from "STP Version" drop-down list.
- Update Setting: Click "Update Setting" button when you finished Global Configuration.

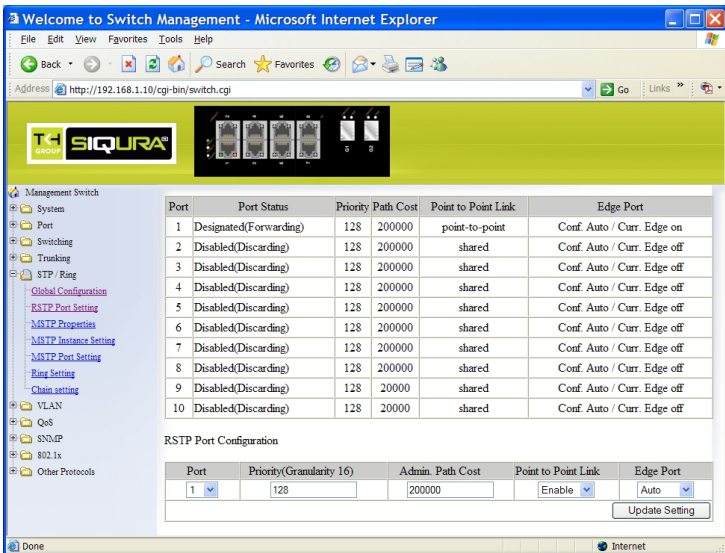

| Port | Port Status | Priority | Path Cost | Point to Point Link | Edge Port |
|------|------------------------|----------|-----------|---------------------|-----------------------------|
| 1 | Designated(Forwarding) | 128 | 200000 | point-to-point | Conf. Auto / Curr. Edge on |
| 2 | Disabled(Discarding) | 128 | 200000 | shared | Conf. Auto / Curr. Edge off |
| 3 | Disabled(Discarding) | 128 | 200000 | shared | Conf. Auto / Curr. Edge off |
| 4 | Disabled(Discarding) | 128 | 200000 | shared | Conf. Auto / Curr. Edge off |
| 5 | Disabled(Discarding) | 128 | 200000 | shared | Conf. Auto / Curr. Edge off |
| 6 | Disabled(Discarding) | 128 | 200000 | shared | Conf. Auto / Curr. Edge off |
| 7 | Disabled(Discarding) | 128 | 200000 | shared | Conf. Auto / Curr. Edge off |
| 8 | Disabled(Discarding) | 128 | 200000 | shared | Conf. Auto / Curr. Edge off |
| 9 | Disabled(Discarding) | 128 | 20000 | shared | Conf. Auto / Curr. Edge off |
| 10 | Disabled(Discarding) | 128 | 20000 | shared | Conf. Auto / Curr. Edge off |

RSTP Port Configuration

| Port | Priority(Granularity 16) | Admin. Path Cost | Point to Point Link | Edge Port |
|------|--------------------------|------------------|---------------------|-----------|
| 1 | 128 | 200000 | Enable | Auto |

Update Setting

RSTP Port Setting

1. STP Version: Click "STP Version" drop-down menu to choose "RSTP" from "STP Version" drop-down list.
2. Port: Click "Port" drop-down menu to Choose Port 1 ~ Port 10 from "Port" drop-down list.
3. Priority(Granularity 16): Click in "Priority" text box and enter a value between 0 and 240 to set the priority for the port. A higher priority will designate the port to forward packets first. A lower number denotes a higher priority. This entry must be divisible by 16. The default priority setting is 128.
4. Admin. Path Cost: Click in "Admin. Path Cost" text box and enter a value between 0 and 200000 to set the Admin. Path Cost for the port. 0 (auto) - Setting 0 for the Admin. Path Cost will automatically set the speed for forwarding packets to the port for optimal efficiency. Default port cost: 100Mbps port = 200000. Gigabit port = 20000.
5. Point to Point Link: Click "Point to Point Link" drop-down menu to Choose "Enable" or "Disable" from "Point to Point Link" drop-down list to enable or disable Point to Point Link for the port.
6. Edge Port: Click "Edge Port" drop-down menu to Choose "Enable", "Disable", or "Auto" from "Edge Port" drop-down list to set Enable, Disable, or Auto Edge Port for the port.
7. Update Setting: Click "Update Setting" button when you finished RSTP Port Setting.

Welcome to Switch Management - Microsoft Internet Explorer

Address: http://192.168.1.10/cgi-bin/switch.cgi



Management Switch

- System
- Port
- Switching
- Trunking
- STP / Ring
 - Global Configuration
 - RSTP Port Setting
 - MSTP Properties
 - MSTP Instance Setting
 - MSTP Port Setting
 - Ring Setting
 - Chain setting
- VLAN
- QoS
- SNMP
- 802.1x
- Other Protocols

| Status | |
|---------------------------------|-------------------------|
| Bridge ID | 80000047e000001 |
| Designated Root | 80000047e000001 |
| Reg Root ID | 80000047e000001 |
| Root Port | 0 |
| Root Path Cost | 0 |
| Current Max Age (sec) | 20 |
| Current Hello Time (sec) | 2 |
| Current Forward Delay (sec) | 15 |
| Topology Change Count | 1 |
| Time Since Last Topology Change | Fri Jan 1 22:14:24 2010 |

| Setting | |
|----------------------------|---|
| Spanning Tree Protocol | Enable <input type="button" value="v"/> |
| Bridge Priority (0..61440) | 32768 <input type="text"/> |
| Hello Time (1..10 sec) | 2 <input type="text"/> |
| Max Age (6..40 sec) | 20 <input type="text"/> |
| Forward Delay (4..30 sec) | 15 <input type="text"/> |
| STP Version | MSTP <input type="button" value="v"/> |

Done Internet

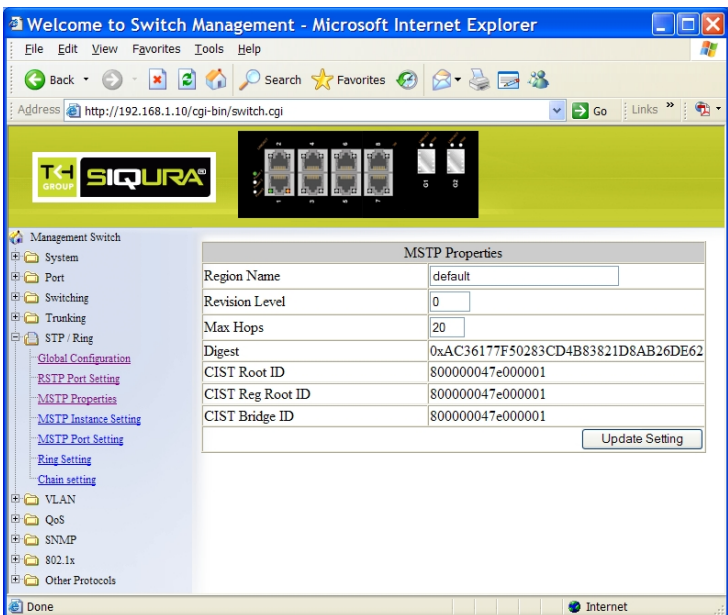

Management Switch

- System
- Port
- Switching
- Trunking
- STP / Ring
 - Global Configuration
 - RSTP Port Setting
 - MSTP Properties**
 - MSTP Instance Setting
 - MSTP Port Setting
 - Ring Setting
 - Chain setting
- VLAN
- QoS
- SNMP
- 802.1x
- Other Protocols

| MSTP Properties | |
|------------------|------------------------------------|
| Region Name | default |
| Revision Level | 0 |
| Max Hops | 20 |
| Digest | 0xAC36177F50283CD4B83821D8AB26DE62 |
| CIST Root ID | 800000047e000001 |
| CIST Reg Root ID | 800000047e000001 |
| CIST Bridge ID | 800000047e000001 |
| Update Setting | |

MSTP Properties

1. STP Version: Click "STP Version" drop-down menu to choose "MSTP" from "STP Version" drop-down list.
2. Region Name: Click in "Region Name" text box to create an MST region and specify a name to it. MST bridges of a region form different spanning trees for different VLANs. By default, each MST bridge starts with the region name as its bridge address. This means each MST bridge is a region by itself, unless specifically added to one.
3. Revision Level: Click in "Revision Level" text box to specify the number for configuration information. The default value of revision number is 0.
4. Max Hops: Click in "Max Hops" text box to specify the maximum allowed hops for BPDU in an MST region. This parameter is used by all the instances of the MST. Specifying the max hops for a BPDU prevents the messages from looping indefinitely in the network. When a bridge receives a MST BPDU that has exceeded the allowed max-hops, it discards the BPDU.
5. Update Setting: Click "Update Setting" button when you finished MSTP Properties setting.

Welcome to Switch Management - Microsoft Internet Explorer

Address: http://192.168.1.10/cgi-bin/switch.cgi



Management Switch

- System
- Port
- Switching
- Trunking
- STP / Ring
 - Global Configuration
 - RSTP Port Setting
 - MSTP Properties
 - MSTP Instance Setting
 - MSTP Port Setting
 - Ring Setting
 - Chain setting
- VLAN
- QoS
- SNMP
- 802.1x
- Other Protocols

VLAN Instance Configuration

| Included VLANs | |
|----------------------------|--------------------------------|
| Instance ID | <input type="text" value="1"/> |
| Included VLAN | <input type="text" value="1"/> |
| Instance Setting | |
| Bridge Priority (0..61440) | <input type="text" value=""/> |
| Root ID | <input type="text" value=""/> |
| Root Port | <input type="text" value=""/> |
| Root Path Cost | <input type="text" value=""/> |
| Bridge ID | <input type="text" value=""/> |

Done Internet

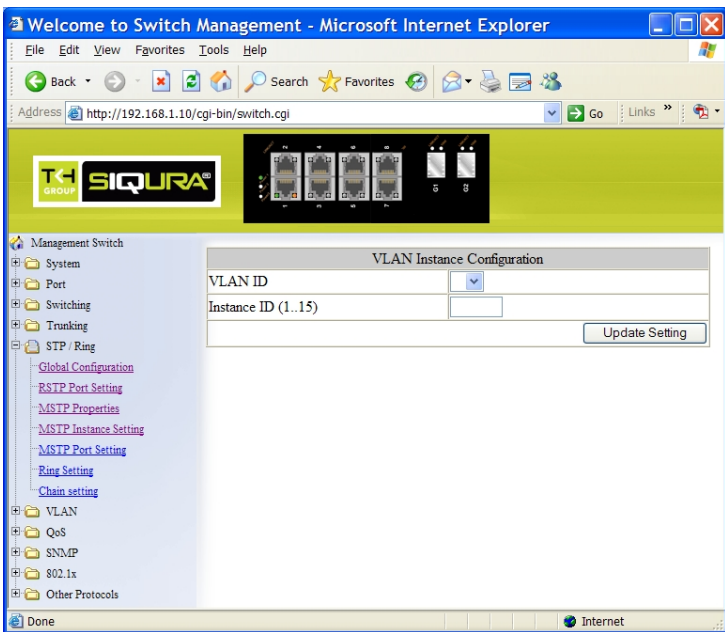

MSTP Instance Setting

VLAN Instance Configuration

1. VLAN Instance Configuration: Click “VLAN Instance Configuration” button. The “VLAN Instance Configuration” window appears.
2. VLAN ID: Click “VLAN ID” drop-down menu to choose VLAN from “VLAN ID” drop-down list to simultaneously add multiple VLANs for the corresponding instance of a bridge.
3. Instance ID (1..15): Click in “Instance ID” text box to specify the instance ID.
4. Update Setting: Click “Update Setting” button when you finished VLAN Instance Configuration.

Included VLANs

1. Instance ID: Click “Instance ID” drop-down menu to choose instance ID from “Instance ID” drop-down list.
2. Included VLAN: Click “Included VLAN” drop-down menu to choose VLAN from “Included VLAN” drop-down list.

Instance Setting

1. Bridge Priority (0..61440): Click in "Bridge Priority" text box to set the bridge priority for an MST instance to the value specified. The lower the priority of the bridge, the better the chances are the bridge becoming a root bridge or a designated bridge for the LAN.
2. Update Setting: Click "Update Setting" button when you finished VLAN Instance Configuration.

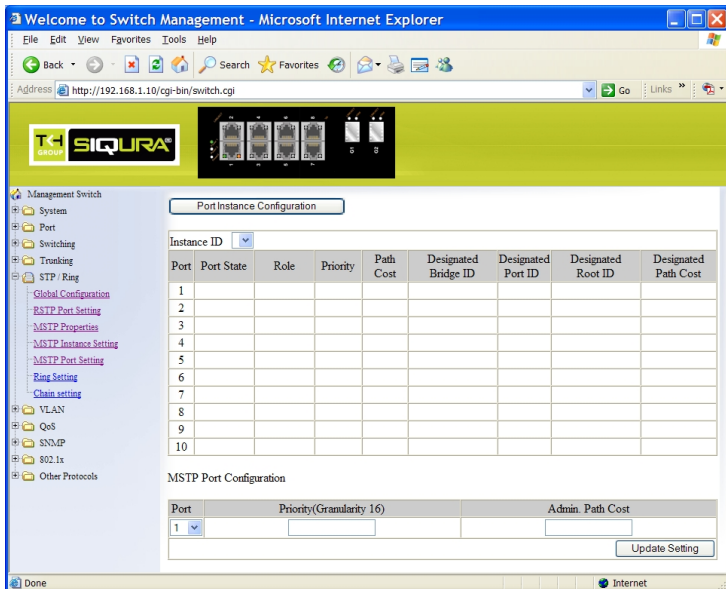

Management Switch

- System
- Port
- Switching
- Trunking
- STP / Ring
 - Global Configuration
 - RSTP Port Setting
 - MSTP Properties
 - MSTP Instance Setting
 - MSTP Port Setting
 - Ring Setting
 - Chain setting
- VLAN
- QoS
- SNMP
- 802.1x
- Other Protocols

Port Instance Configuration

Instance ID:

| Port | Port State | Role | Priority | Path Cost | Designated Bridge ID | Designated Port ID | Designated Root ID | Designated Path Cost |
|------|------------|------|----------|-----------|----------------------|--------------------|--------------------|----------------------|
| 1 | | | | | | | | |
| 2 | | | | | | | | |
| 3 | | | | | | | | |
| 4 | | | | | | | | |
| 5 | | | | | | | | |
| 6 | | | | | | | | |
| 7 | | | | | | | | |
| 8 | | | | | | | | |
| 9 | | | | | | | | |
| 10 | | | | | | | | |

MSTP Port Configuration

| Port | Priority(Granularity 16) | Admin. Path Cost |
|------|--------------------------|----------------------|
| 1 | <input type="text"/> | <input type="text"/> |

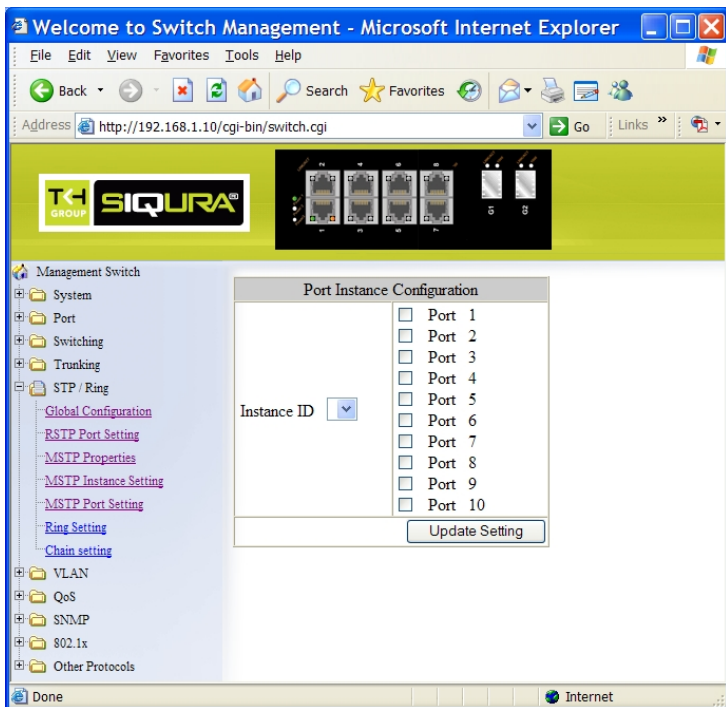

MSTP Port Setting

Port Instance Configuration

1. Instance ID: Click "Instance ID" drop-down menu to choose instance ID from "Instance ID" drop-down list.
2. Click Port 1 ~ Port 10 to assign ports to the corresponding instance ID.
3. Update Setting: Click "Update Setting" button when you finished Port Instance Configuration.

Instance ID

1. Instance ID: Click "Instance ID" drop-down menu to choose instance ID from "Instance ID" drop-down list.

MSTP Port Configuration

1. Port: Click "Port" drop-down menu to choose port from "Port" drop-down list.
2. Priority(Granularity 16): Click in "Priority" text box to set the port priority for a bridge group. The Multiple Spanning Tree Protocol uses port priority as a tiebreaker to determine which port should forward frames for a particular instance on a LAN, or which port should be the root port

for an instance. A lower value implies a better priority. In the case of the same priority, the interface index will serve as the tiebreaker, with the lower-numbered interface being preferred over others. The permitted range is 0-240. The priority values can only be set in increments of 16.

- Admin. Path Cost: Click in “Admin. Path Cost” text box to set the cost of a path associated with an interface.
- Update Setting: Click “Update Setting” button when you finished MSTP Port Setting.

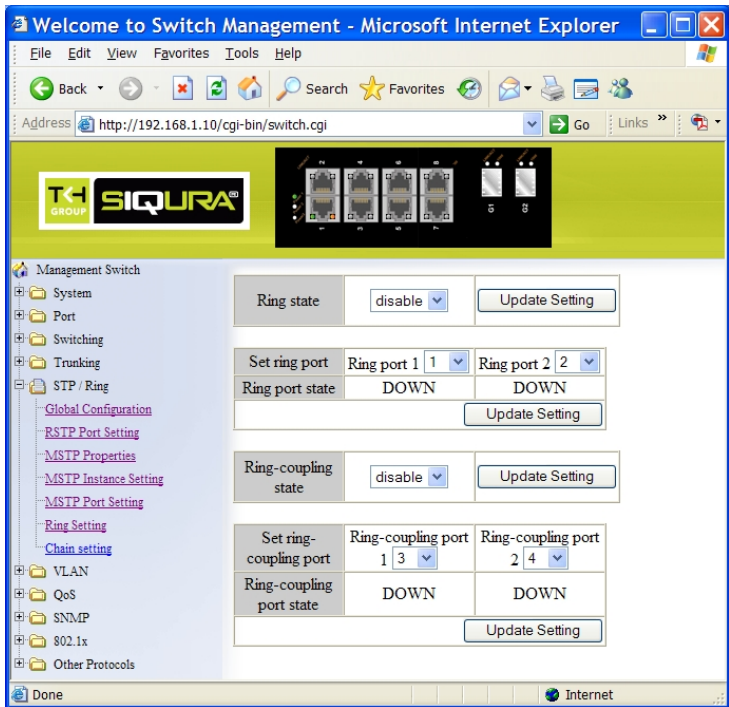

Ring Setting

Ring state

- Click “Ring state” drop-down menu from “Ring state” drop-down list to choose “Enable” or “Disable” to enable or disable Ring state.
- Update Setting: Click “Update Setting” button when you finished Ring state setting.

Set ring port

- Ring port 1: Click “Ring port 1” drop-down menu to choose Ring port 1 from “Ring port 1” drop-down list.

2. Ring port 2: Click “Ring port 2” drop-down menu to choose Ring port 2 from “Ring port 2” drop-down list.
3. Update Setting: Click “Update Setting” button when you finished Set ring port.

Ring-coupling state

1. Click “Ring-coupling state” drop-down menu from “Ring-coupling state” drop-down list to choose “Enable” or “Disable” to enable or disable Ring-coupling state.
2. Update Setting: Click “Update Setting” button when you finished Ring-coupling state setting.

Set ring-coupling port

1. Ring-coupling port 1: Click “Ring-coupling port 1” drop-down menu to choose Ring-coupling port 1 from “Ring-coupling port 1” drop-down list.
2. Ring-coupling port 2: Click “Ring-coupling port 2” drop-down menu to choose Ring-coupling port 2 from “Ring-coupling port 2” drop-down list.
3. Update Setting: Click “Update Setting” button when you finished Set ring-coupling port.

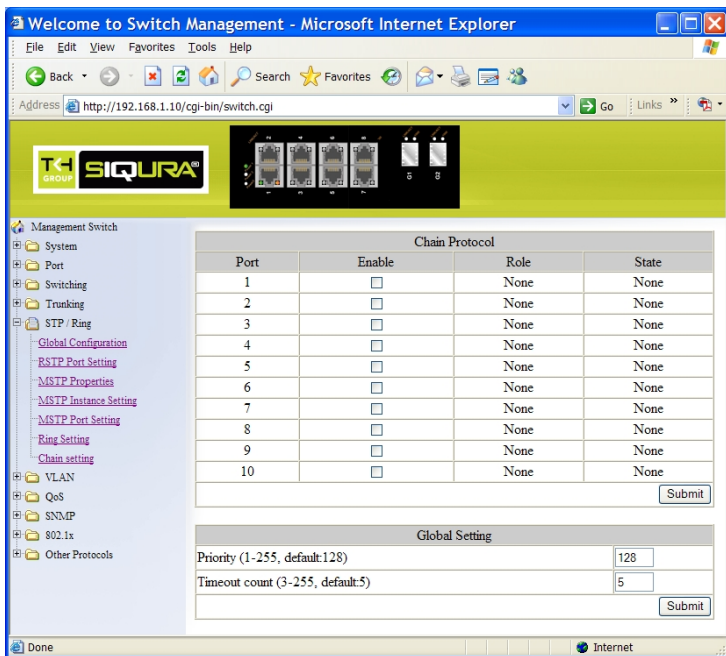

The screenshot shows the 'Chain Protocol' configuration page. It contains a table with the following data:

| Chain Protocol | | | | |
|----------------|--------------------------|------|-------|--|
| Port | Enable | Role | State | |
| 1 | <input type="checkbox"/> | None | None | |
| 2 | <input type="checkbox"/> | None | None | |
| 3 | <input type="checkbox"/> | None | None | |
| 4 | <input type="checkbox"/> | None | None | |
| 5 | <input type="checkbox"/> | None | None | |
| 6 | <input type="checkbox"/> | None | None | |
| 7 | <input type="checkbox"/> | None | None | |
| 8 | <input type="checkbox"/> | None | None | |
| 9 | <input type="checkbox"/> | None | None | |
| 10 | <input type="checkbox"/> | None | None | |

Below the table is a 'Submit' button. The 'Global Setting' section contains the following fields:

- Priority (1-255, default:128):
- Timeout count (3-255, default:5):

A 'Submit' button is located at the bottom right of the Global Setting section.

Chain Setting

Chain Protocol

1. Click "Enable" to enable Chain Protocol for Port 1 ~ Port 10. The Chain Protocol supports up to total 8 ports.
2. Submit: Click "Submit" button when you finished Chain Protocol setting.

Global Setting

1. Priority (1-255, default:128): Set the Switch priority for running chain protocol. Switch with lower priority will run as Master (forwarding) port.
2. Timeout count (3-255, default:5): Set the Switch timeout count for running chain protocol.

Chain recovery time = (Chain Timeout Count – 1) x 200ms.

Default Chain recovery time = (5 – 1) x 200ms = 800ms.

3. Submit: Click "Submit" button when you finished Chain Protocol setting.

VLAN

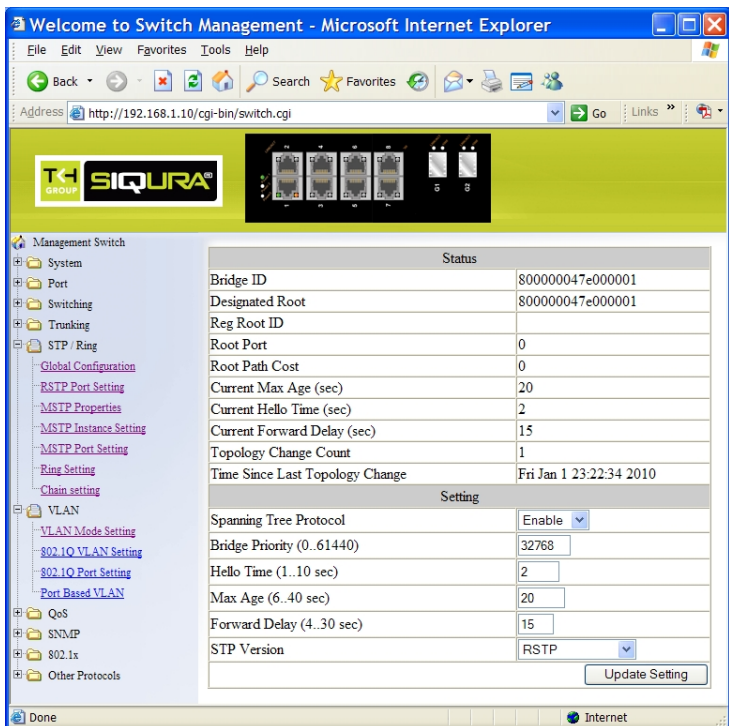

| Status | |
|---------------------------------|-------------------------|
| Bridge ID | 800000047e000001 |
| Designated Root | 800000047e000001 |
| Reg Root ID | |
| Root Port | 0 |
| Root Path Cost | 0 |
| Current Max Age (sec) | 20 |
| Current Hello Time (sec) | 2 |
| Current Forward Delay (sec) | 15 |
| Topology Change Count | 1 |
| Time Since Last Topology Change | Fri Jan 1 23:22:34 2010 |

| Setting | |
|----------------------------|--------|
| Spanning Tree Protocol | Enable |
| Bridge Priority (0..61440) | 32768 |
| Hello Time (1..10 sec) | 2 |
| Max Age (6..40 sec) | 20 |
| Forward Delay (4..30 sec) | 15 |
| STP Version | RSTP |

VLAN Mode Setting

1. VLAN Mode Setting: Click "VLAN Mode Setting" drop-down menu to choose "Tag-based VLAN" or "Port-based VLAN" from "VLAN Mode Setting" drop-down list.
2. Update Setting: Click "Update Setting" button when you finished VLAN Mode Setting.

Welcome to Switch Management - Microsoft Internet Explorer

Address: <http://192.168.1.10/cgi-bin/switch.cgi>



Management Switch

- System
- Port
- Switching
- Trunking
- STP / Ring
 - Global Configuration
 - RSTP Port Setting
 - MSTP Properties
 - MSTP Instance Setting
 - MSTP Port Setting
 - Ring Setting
 - Chain setting
- VLAN
 - VLAN Mode Setting
 - 802.1Q VLAN Setting
 - 802.1Q Port Setting
 - Port Based VLAN
- QoS
- SNMP
- 802.1x
- Other Protocols

VLAN Mode 1 : Tag-Based VLAN

| VLAN Setting | | Add VLAN | Delete VLAN |
|--------------|-----------|----------|-------------|
| VLAN ID | VLAN NAME | | |
| <u>VLAN1</u> | | | |

Done Internet

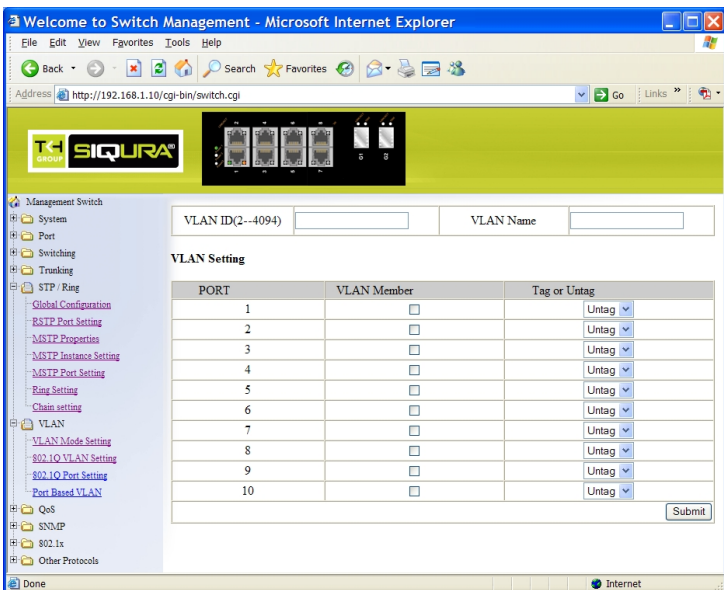

VLAN ID(2--4094) VLAN Name

VLAN Setting

| PORT | VLAN Member | Tag or Untag |
|------|--------------------------|--------------|
| 1 | <input type="checkbox"/> | Untag ▼ |
| 2 | <input type="checkbox"/> | Untag ▼ |
| 3 | <input type="checkbox"/> | Untag ▼ |
| 4 | <input type="checkbox"/> | Untag ▼ |
| 5 | <input type="checkbox"/> | Untag ▼ |
| 6 | <input type="checkbox"/> | Untag ▼ |
| 7 | <input type="checkbox"/> | Untag ▼ |
| 8 | <input type="checkbox"/> | Untag ▼ |
| 9 | <input type="checkbox"/> | Untag ▼ |
| 10 | <input type="checkbox"/> | Untag ▼ |

802.1Q VLAN Setting

Add VLAN:

1. 802.1Q VLAN Setting: Click “802.1Q VLAN Setting”. The “VLAN Setting” window appears.
2. Add VLAN: Click “Add VLAN” button to create a new VLAN from “VLAN Setting” window.
3. VLAN ID(2-4094): Click in the “VLAN ID” textbox and specify a new VLAN ID number from 2 ~ 4094.
4. VLAN Name: Click in the “VLAN Name” textbox and type a name for this newly created VLAN.

Add port to or delete port from VLAN:

1. VLAN Member: Choose the port to be added to or deleted from the VLAN.
2. Tag or Untag: Click “Tag or Untag” drop-down menu to Choose “Tag” or “Untag” from “Tag or Untag” drop-down list for a “Hybrid” port.
3. Submit: Click “Submit” button when you finished VLAN setting.

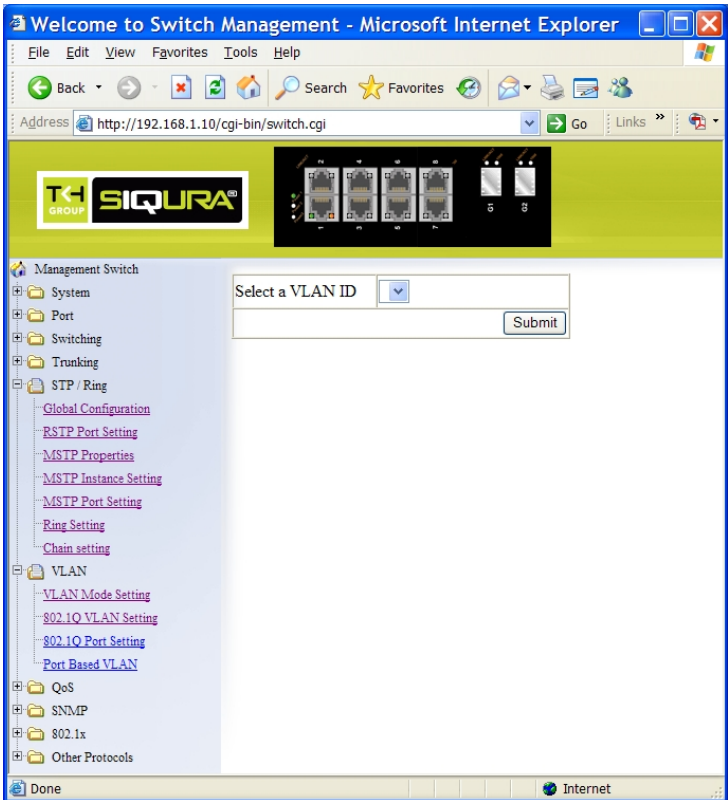

Delete VLAN:

1. 802.1Q VLAN Setting: Click "802.1Q VLAN Setting". The "VLAN Setting" window appears.
2. Delete VLAN: Click "Delete VLAN" button.
3. Select a VLAN ID: Click "Select a VLAN ID" drop-down menu from "Select a VLAN ID" drop-down list to choose the VLAN to be deleted.
4. Submit: Click "Submit" button when you finished VLAN setting.

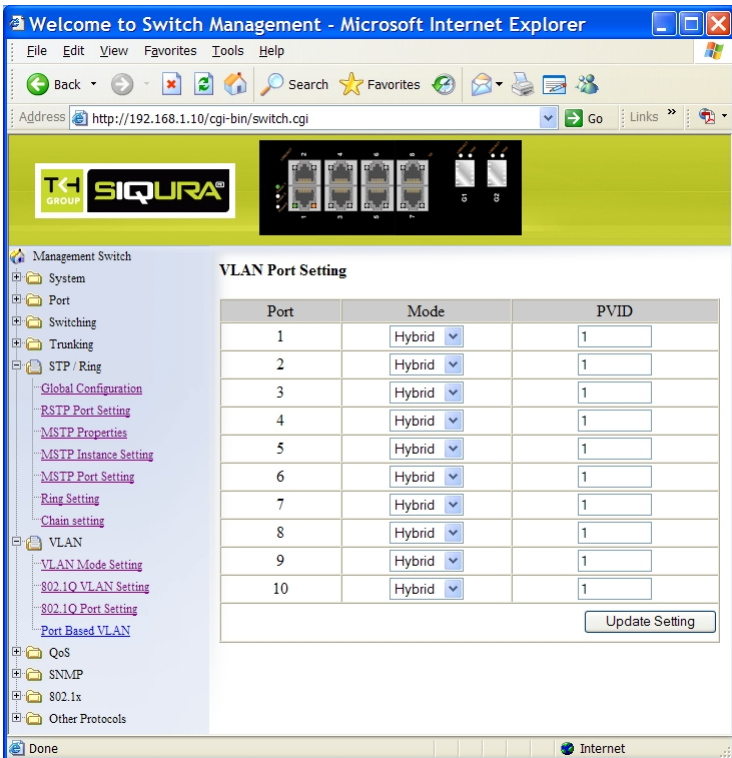

Management Switch

- System
- Port
- Switching
- Trunking
- STP / Ring
 - Global Configuration
 - RSTP Port Setting
 - MSTP Properties
 - MSTP Instance Setting
 - MSTP Port Setting
 - Ring Setting
 - Chain setting
- VLAN
 - VLAN Mode Setting
 - 802.1Q VLAN Setting
 - 802.1Q Port Setting
 - Port Based VLAN
- QoS
- SNMP
- 802.1x
- Other Protocols

VLAN Port Setting

| Port | Mode | PVID |
|------|--------|------|
| 1 | Hybrid | 1 |
| 2 | Hybrid | 1 |
| 3 | Hybrid | 1 |
| 4 | Hybrid | 1 |
| 5 | Hybrid | 1 |
| 6 | Hybrid | 1 |
| 7 | Hybrid | 1 |
| 8 | Hybrid | 1 |
| 9 | Hybrid | 1 |
| 10 | Hybrid | 1 |

Update Setting

802.1Q Port Setting

1. VLAN Port Setting: Click "VLAN Port Setting". The "VLAN Port Setting" window appears.
2. Mode: Click "Mode" drop-down menu to choose "Access", "Trunk", or "Hybrid" from "Mode" drop-down list for the port. The port will be Tag port if you choose "Trunk" Mode for the port. And the port will be Tag or Untag port if you choose "Hybrid" Mode for the port.
3. PVID: Click in the "PVID" textbox and specify a new PVID number for the port.
4. Update Setting: Click "Update Setting" button when you finished VLAN Port Setting.

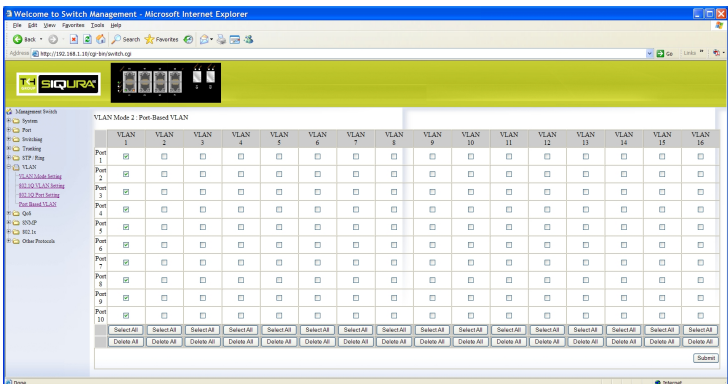
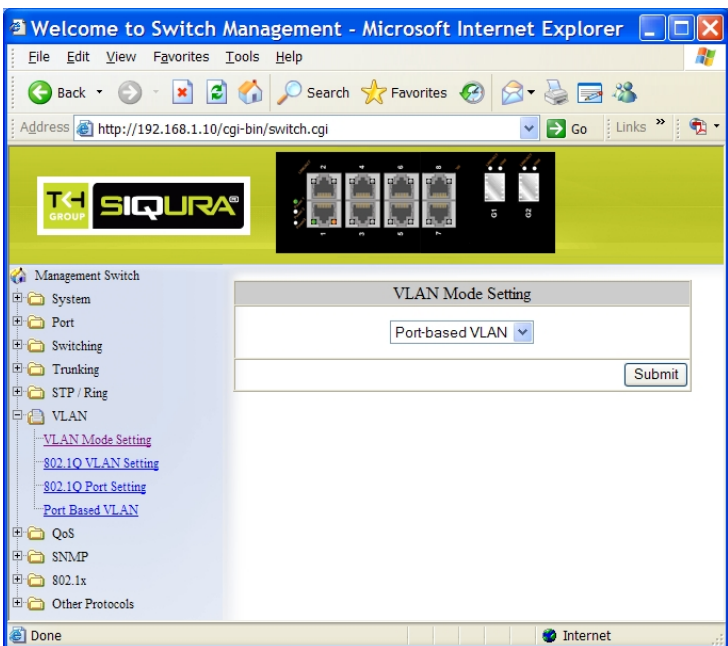

Port Based VLAN

1. VLAN: Choose the port to be added to or deleted from the VLAN.
2. Select all: Click "select all" button to choose Port 1 ~ Port 10 all to be

added to the VLAN.

3. Delete all: Click "delete all" button to choose Port 1 ~ Port 10 all to be deleted from the VLAN.
4. Submit: Click "Submit" button when you finished Port Based VLAN setting.

QoS

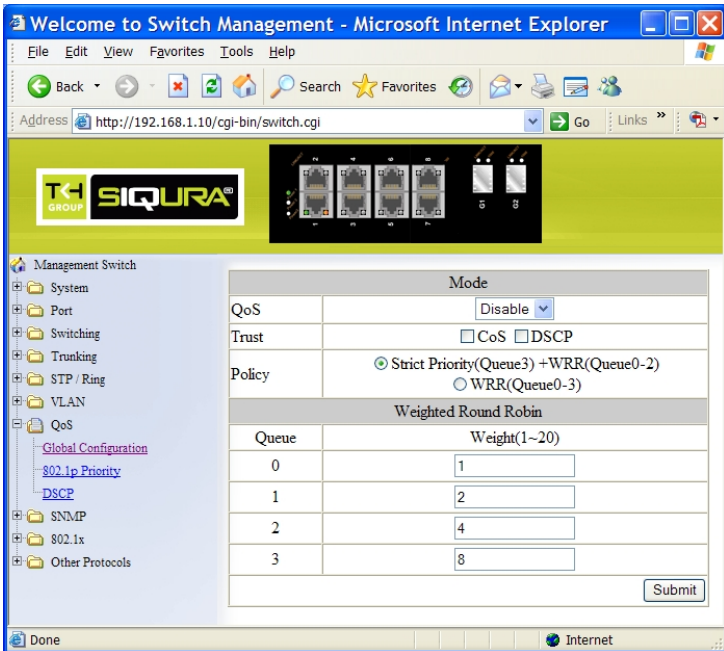

Mode

QoS:

Trust: CoS DSCP

Policy: Strict Priority(Queue3) + WRR(Queue0-2) WRR(Queue0-3)

Weighted Round Robin

| Queue | Weight(1~20) |
|-------|--------------------------------|
| 0 | <input type="text" value="1"/> |
| 1 | <input type="text" value="2"/> |
| 2 | <input type="text" value="4"/> |
| 3 | <input type="text" value="8"/> |

Global Configuration

1. QoS: Click “QoS” drop-down menu from “QoS” drop-down list to choose “Enable” or “Disable” to enable or disable QoS.
2. Trust: Enable or disable the switch port to trust the CoS (Class of Service) labels of all traffic received on that port. Enable or disable a routed port to trust the DSCP (Differentiated Service Code Point) labels of all traffic received on that port.
3. Policy: Choose “Strict Priority(Queue3) + WRR(Queue0-2)” or “WRR(Queue0-3)”. A strict priority queue is always emptied first. The queues that are used in the WRR (Weighted Round Robin) are emptied in a round-robin fashion, and you can configure the weight for each queue.
4. Weighted Round Robin: Click in the “Weight(1~55)” textbox and specify a new number from 1 ~ 55 for Queue 0 ~ 3.
5. Submit: Click “Submit” button when you finished Global Configuration.

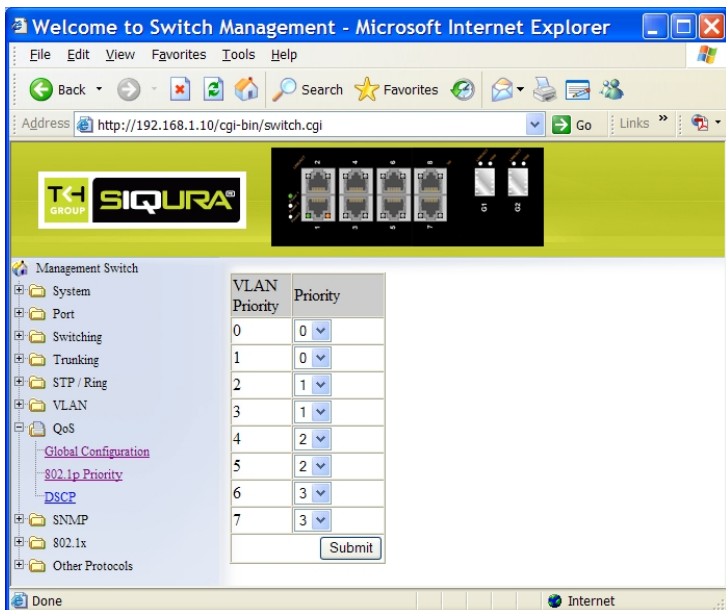

| VLAN Priority | Priority |
|---------------|----------|
| 0 | 0 |
| 1 | 0 |
| 2 | 1 |
| 3 | 1 |
| 4 | 2 |
| 5 | 2 |
| 6 | 3 |
| 7 | 3 |

802.1p Priority

1. Priority: Click "Priority" drop-down menu from "Priority" drop-down list to choose 0 ~ 3 for VLAN Priority 0 ~ 7.
2. Submit: Click "Submit" button when you finished 802.1p priority.

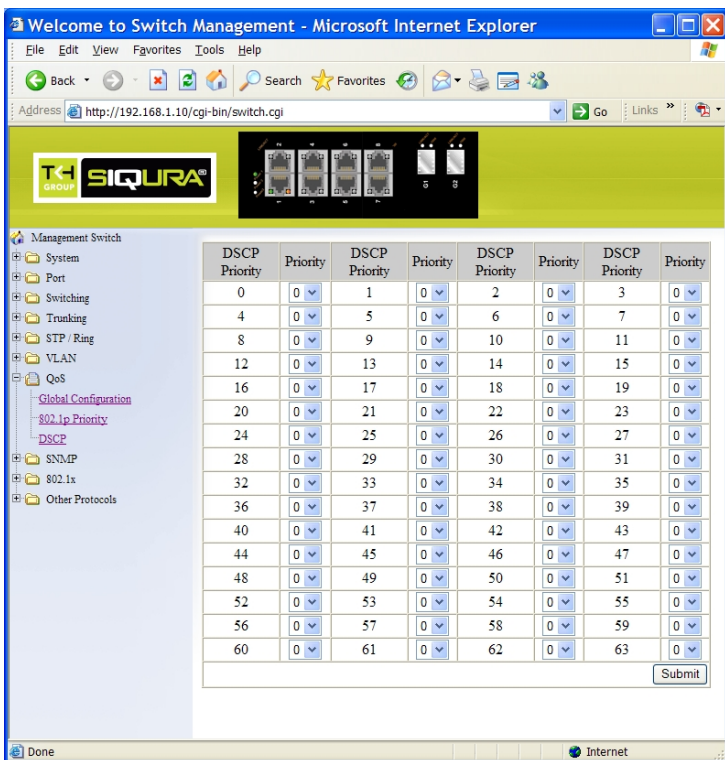

| DSCP Priority | Priority | DSCP Priority | Priority | DSCP Priority | Priority | DSCP Priority | Priority |
|---------------|----------|---------------|----------|---------------|----------|---------------|----------|
| 0 | 0 | 1 | 0 | 2 | 0 | 3 | 0 |
| 4 | 0 | 5 | 0 | 6 | 0 | 7 | 0 |
| 8 | 0 | 9 | 0 | 10 | 0 | 11 | 0 |
| 12 | 0 | 13 | 0 | 14 | 0 | 15 | 0 |
| 16 | 0 | 17 | 0 | 18 | 0 | 19 | 0 |
| 20 | 0 | 21 | 0 | 22 | 0 | 23 | 0 |
| 24 | 0 | 25 | 0 | 26 | 0 | 27 | 0 |
| 28 | 0 | 29 | 0 | 30 | 0 | 31 | 0 |
| 32 | 0 | 33 | 0 | 34 | 0 | 35 | 0 |
| 36 | 0 | 37 | 0 | 38 | 0 | 39 | 0 |
| 40 | 0 | 41 | 0 | 42 | 0 | 43 | 0 |
| 44 | 0 | 45 | 0 | 46 | 0 | 47 | 0 |
| 48 | 0 | 49 | 0 | 50 | 0 | 51 | 0 |
| 52 | 0 | 53 | 0 | 54 | 0 | 55 | 0 |
| 56 | 0 | 57 | 0 | 58 | 0 | 59 | 0 |
| 60 | 0 | 61 | 0 | 62 | 0 | 63 | 0 |

DSCP

1. Priority: Click "Priority" drop-down menu from "Priority" drop-down list to choose 0 ~ 3 for DSCP Priority 0 ~ 3.
2. Submit: Click "Submit" button when you finished DSCP.

SNMP

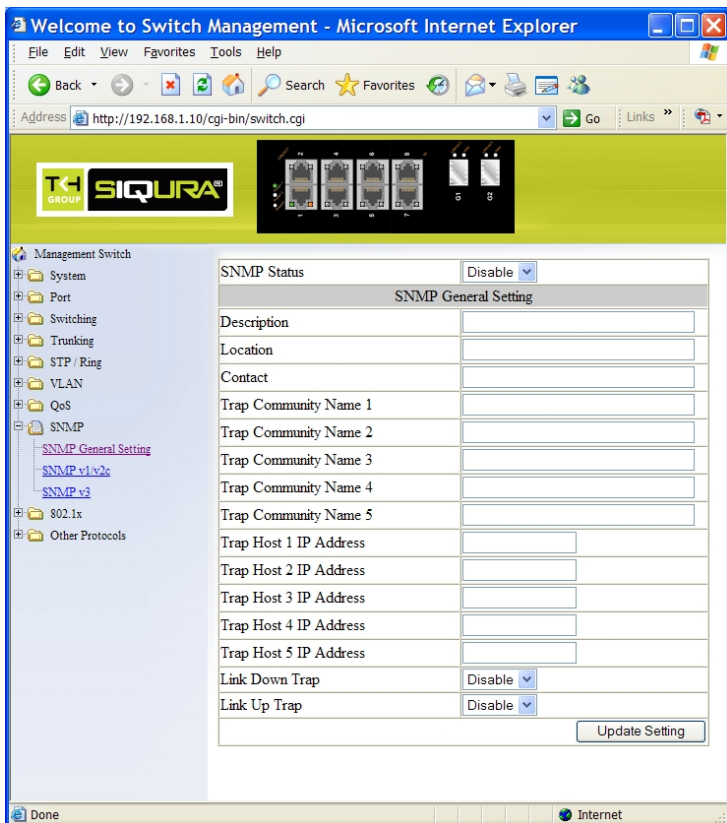

Management Switch

- System
- Port
- Switching
- Trunking
- STP / Ring
- VLAN
- QoS
- SNMP
 - [SNMP General Setting](#)
 - [SNMP v1/v2c](#)
 - [SNMP v3](#)
- 802.1x
- Other Protocols

SNMP Status: Disable

SNMP General Setting

| | |
|------------------------|----------------------|
| Description | <input type="text"/> |
| Location | <input type="text"/> |
| Contact | <input type="text"/> |
| Trap Community Name 1 | <input type="text"/> |
| Trap Community Name 2 | <input type="text"/> |
| Trap Community Name 3 | <input type="text"/> |
| Trap Community Name 4 | <input type="text"/> |
| Trap Community Name 5 | <input type="text"/> |
| Trap Host 1 IP Address | <input type="text"/> |
| Trap Host 2 IP Address | <input type="text"/> |
| Trap Host 3 IP Address | <input type="text"/> |
| Trap Host 4 IP Address | <input type="text"/> |
| Trap Host 5 IP Address | <input type="text"/> |
| Link Down Trap | Disable |
| Link Up Trap | Disable |

Update Setting

SNMP General Setting

1. SNMP Status: Click "SNMP Status" drop-down menu from "SNMP Status" drop-down list to choose "Enable" or "Disable" to enable or disable SNMP.
2. Description: Click in the "Description" textbox and specify a new description for SNMP.
3. Location: Click in the "Location" textbox and specify a new location for SNMP.

4. Contact: Click in the “Contact” textbox and specify a new contact for SNMP.
5. Trap Community Name: For each “Trap Community Name”, Click in the “Trap Community Name” textbox and specify a trap community name.
6. Trap Host IP Address: For each “Trap Host IP Address”, Click in the “Trap Host IP Address” textbox and specify a trap host IP address.
7. Link Down Trap: Click “Link Down Trap” drop-down menu from “Link Down Trap” drop-down list to choose “Enable” or “Disable” to enable or disable link down trap.
8. Link Up Trap: Click “Link Up Trap” drop-down menu from “Link Up Trap” drop-down list to choose “Enable” or “Disable” to enable or disable link up trap.
9. Update Setting: Click “Update Setting” button when you finished SNMP General Setting.

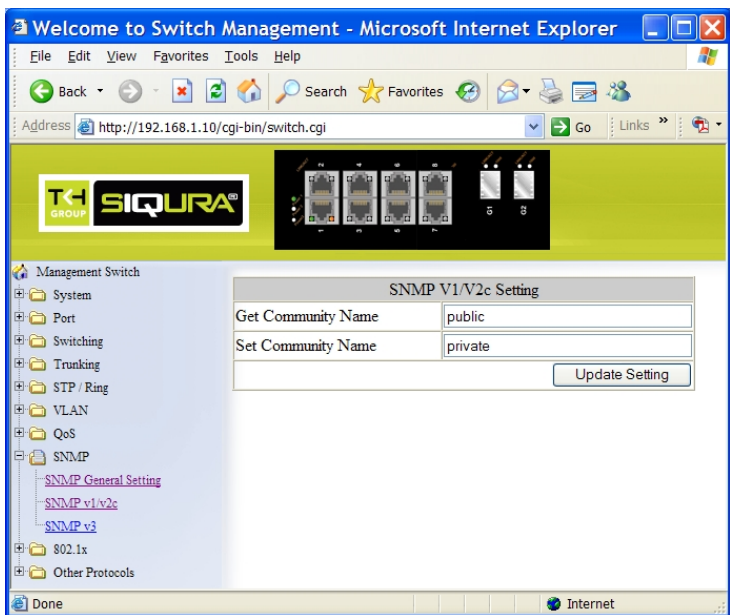

SNMP v1/v2c

1. Get Community Name: Click in the “Get Community Name” textbox and specify a get community name.
2. Set Community Name: Click in the “Set Community Name” textbox and specify a set community name.
3. Update Setting: Click “Update Setting” button when you finished SNMP V1/V2c Setting.

Welcome to Switch Management - Microsoft Internet Explorer

File Edit View Favorites Tools Help

Address http://192.168.1.10/cgi-bin/switch.cgi



Management Switch

- System
- Port
- Switching
- Trunking
- STP / Ring
- VLAN
- QoS
- SNMP
 - SNMP General Setting
 - SNMP v1/v2c
 - SNMP v3
- 802.1x
- Other Protocols

SNMPv3 Setting

| User Name | Access Mode | Security Level | Authentication Type | Privacy Type |
|-----------|-------------|----------------|---------------------|--------------|
| | | | | |

Done Internet

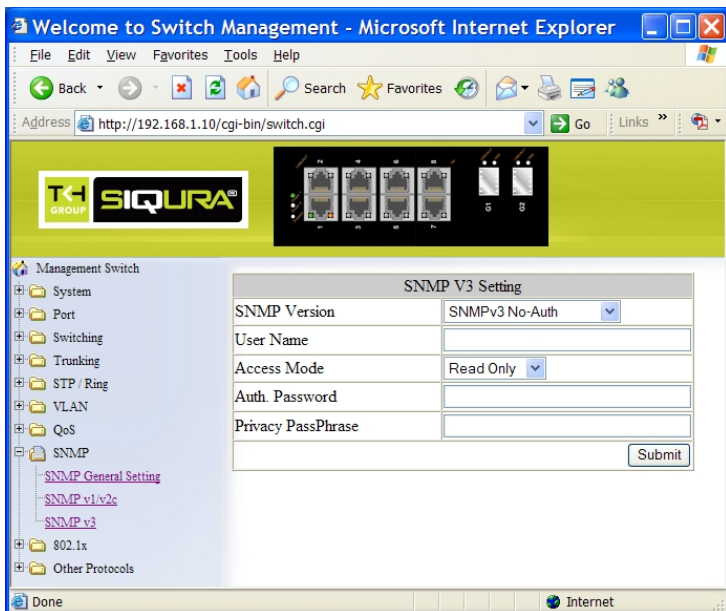

SNMP v3

Add User:

1. Add User: Click “Add User” button. The “SNMP V3 Setting” window appears.
2. SNMP Version: Click “SNMP Version” drop-down menu from “SNMP Version” drop-down list to choose “SNMPv3 No-Auth”, “SNMPv3 Auth-MD5”, “SNMPv3 Auth-SHA”, “SNMPv3 Priv Auth-MD5”, or “SNMPv3 Priv Auth-SHA”.
 - SNMPv3 No-Auth: Add a user using SNMP v3 without authentication.
 - SNMPv3 Auth-MD5: Add a user using SNMP v3 with authentication. Click in the “Auth. Password” textbox and specify an authentication password.
 - SNMPv3 Auth-SHA: Add a user using SNMP v3 with authentication. Click in the “Auth. Password” textbox and specify an authentication password.
 - SNMPv3 Priv Auth-MD5: Add a user using SNMP v3 with authentication and privacy. Click in the “Auth. Password” textbox and specify an authentication password. Click in the “Privacy PassPhrase” textbox and specify a privacy pass phrase.
 - SNMPv3 Priv Auth-SHA: Add a user using SNMP v3 with authentication and privacy. Click in the “Auth. Password” textbox and specify an authentication password. Click in the “Privacy PassPhrase” textbox and specify a privacy pass phrase.

3. User Name: Click in the “User Name” textbox and specify a user name for user using SNMP v3.
4. Access Mode: Click “Access Mode” drop-down menu from “Access Mode” drop-down list to choose “Read Only” or “Read/Write”.
 - Read Only: Add a user using SNMP v3 with read-only access mode.
 - Read/Write: Add an user using SNMP v3 with read-write access mode
5. Sumit: Click “Sumit” button when you finished SNMP V3 Setting.

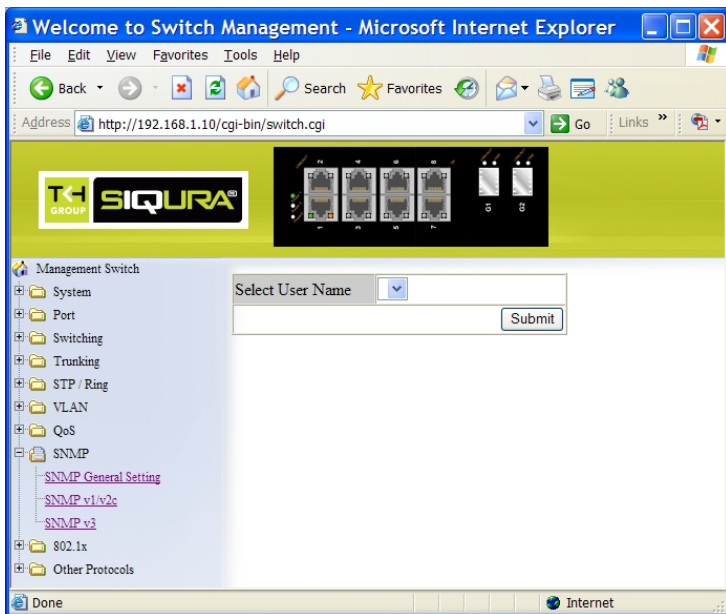
Delete User:

1. Delete User: Click “Delete User” button. The “Select User Name” window appears.
2. Select User Name: Click “Select User Name” drop-down menu from “Select User Name” drop-down list to choose the user to be deleted from using SNMP v3.
3. Sumit: Click “Sumit” button when you finished user deletion.

802.1x

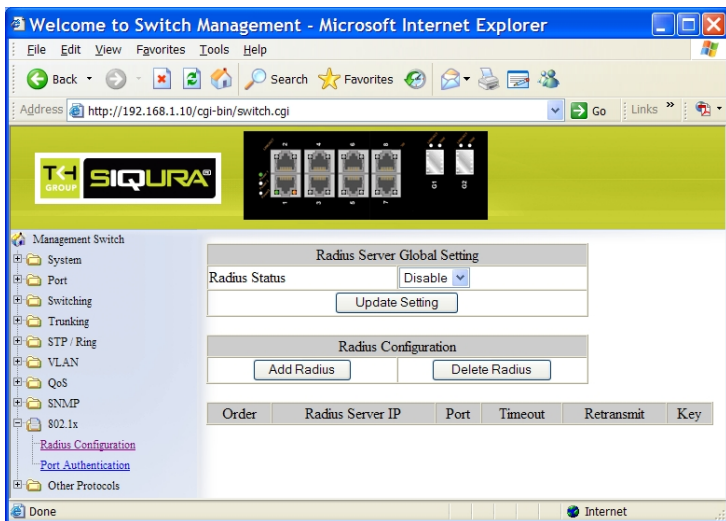

Management Switch

- System
- Port
- Switching
- Trunking
- STP / Ring
- VLAN
- QoS
- SNMP
- 802.1x
 - Radius Configuration
 - Port Authentication
- Other Protocols

Radius Server Global Setting

Radius Status: ▼

Radius Configuration

| Order | Radius Server IP | Port | Timeout | Retransmit | Key |
|-------|------------------|------|---------|------------|-----|
| | | | | | |

Radius Configuration

1. Radius Status: Click "Radius Status" drop-down menu from "Radius Status" drop-down list to choose "Enable" or "Disable" to globally enable or disable authentication.
2. Update Setting: Click "Update Setting" button when you finished Radius Status Setting.

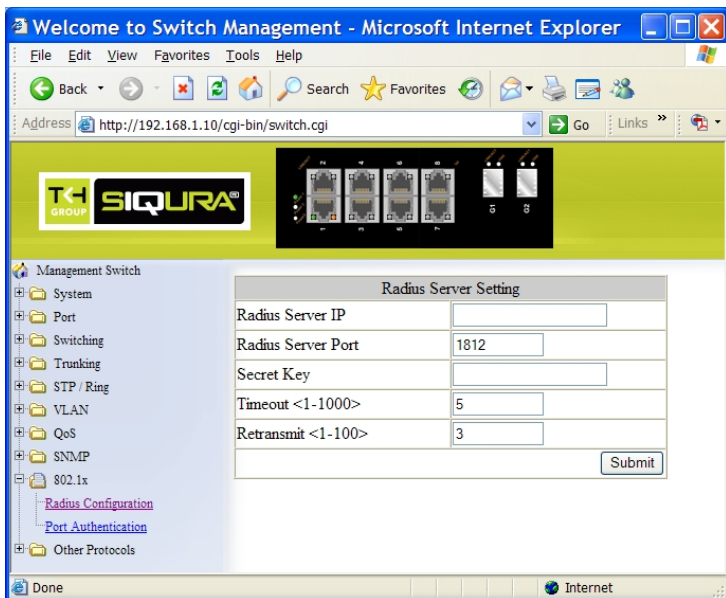

Add Radius:

1. Add Radius: Click "Add Radius" button. The "Radius Server Setting" window appears.
2. Radius Server IP: Click in the "Radius Server IP" textbox and specify the IP address of the remote radius server host.
3. Radius Server Port: Click in the "Radius Server Port" textbox and specify the UDP destination port for authentication requests. The host is not used for authentication if set to 0.
4. Secret Key: Click in the "Secret Key" textbox and specify the authentication and encryption key for all radius communications between the Switch and radius server. This key must match the encryption used on the radius daemon. All leading spaces are ignored, but spaces within and at the end of the key are used. If spaces are used in the key, do not enclose the key in quotation marks unless the quotation marks themselves are part of the key.
5. Timeout <1-1000>: Click in the "Timeout" textbox and specify the time interval (in seconds) that the Switch waits for the radius server to reply before retransmitting. Enter a value in the range 1 to 1000.
6. Retransmit <1-100>: Click in the "Retransmit" textbox and specify the number of times a radius request is resent to a server if that server is not responding or responding slowly. Enter a value in the range 1 to 100.
7. Sumit: Click "Sumit" button when you finished Radius Server Setting.



Delete Radius:

1. Delete Radius: Click "Delete Radius" button. The "Select Radius Server IP" window appears.
2. Select Radius Server IP: Click "Select Radius Server IP" drop-down menu from "Select Radius Server IP" drop-down list to choose the IP address of the remote radius server host to be deleted.
3. Sumit: Click "Sumit" button when you finished radius server deletion.

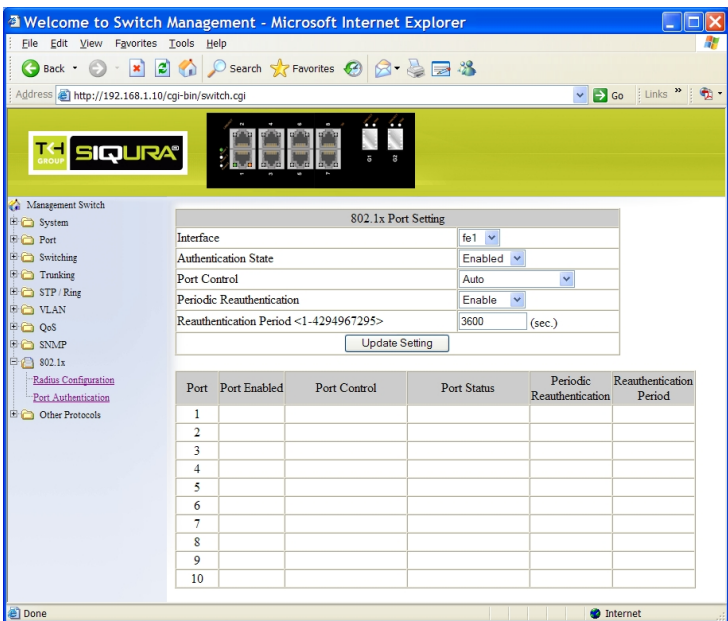

| Port | Port Enabled | Port Control | Port Status | Periodic Reauthentication | Reauthentication Period |
|------|--------------|--------------|-------------|---------------------------|-------------------------|
| 1 | | | | | |
| 2 | | | | | |
| 3 | | | | | |
| 4 | | | | | |
| 5 | | | | | |
| 6 | | | | | |
| 7 | | | | | |
| 8 | | | | | |
| 9 | | | | | |
| 10 | | | | | |

Port Authentication

1. Interface: Click "Interface" drop-down menu from "Interface" drop-down list to choose the port to be set port-based authentication.
2. Authentication State: Click "Authentication State" drop-down menu from "Authentication State" drop-down list to choose "Enable" or "Disable" to enable or disable authentication state.
3. Port Control: Click "Port Control" drop-down menu from "Port Control" drop-down list to choose "Auto", "Force Authorized", or "Force Unauthorized" to force a port state. "Auto" specifies to enable authentication on port. "Force Authorized" specifies to force a port to always be in an authorized state. "Force Unauthorized" specifies to force a port to always be in an unauthorized state.
4. Periodic Reauthentication: Click "Periodic Reauthentication" drop-down menu from "Periodic Reauthentication" drop-down list to choose "Enable" or "Disable" to enable or disable periodic reauthentication.
5. Reauthentication Period <1-4294967295>: Click in the "Reauthentication Period" textbox and specify the seconds between reauthorization attempts. The default time is 3600 seconds.
6. Update Setting: Click "Update Setting" button when you finished port-based authentication setting.

Other Protocols

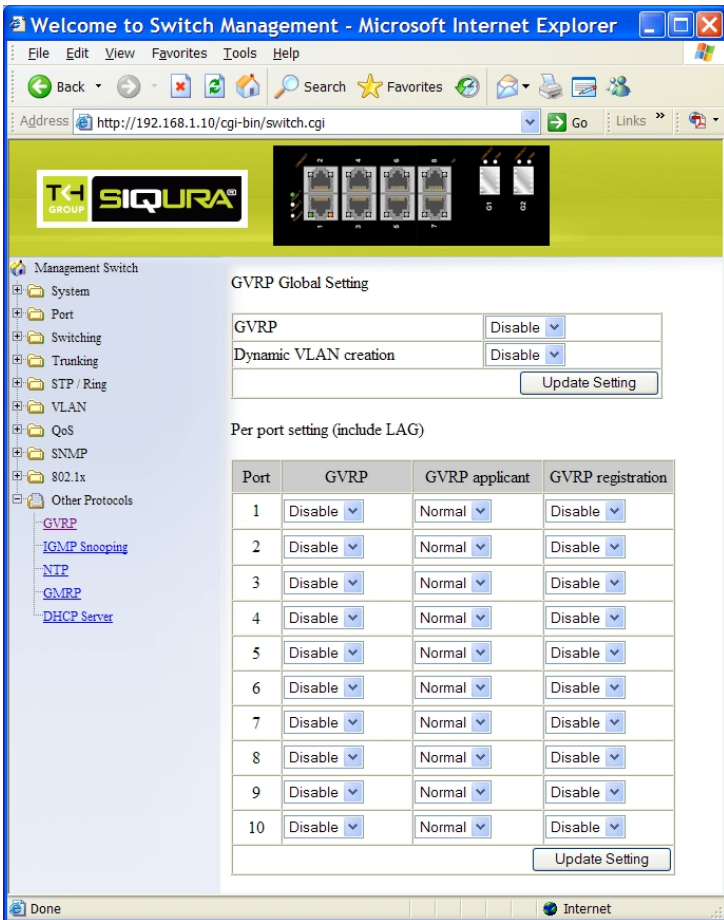

The screenshot shows the 'Welcome to Switch Management' page in Microsoft Internet Explorer. The address bar shows `http://192.168.1.10/cgi-bin/switch.cgi`. The left sidebar contains a navigation tree with 'Other Protocols' expanded to show 'GVRP'. The main content area is titled 'GVRP Global Setting' and contains the following form:

| | |
|-----------------------|---------|
| GVRP | Disable |
| Dynamic VLAN creation | Disable |
| Update Setting | |

Below this is the 'Per port setting (include LAG)' section, which contains a table with 10 rows (ports 1-10) and 4 columns: Port, GVRP, GVRP applicant, and GVRP registration. All GVRP and GVRP registration settings are currently set to 'Disable', and all GVRP applicant settings are set to 'Normal'.

| Port | GVRP | GVRP applicant | GVRP registration |
|------|---------|----------------|-------------------|
| 1 | Disable | Normal | Disable |
| 2 | Disable | Normal | Disable |
| 3 | Disable | Normal | Disable |
| 4 | Disable | Normal | Disable |
| 5 | Disable | Normal | Disable |
| 6 | Disable | Normal | Disable |
| 7 | Disable | Normal | Disable |
| 8 | Disable | Normal | Disable |
| 9 | Disable | Normal | Disable |
| 10 | Disable | Normal | Disable |

Update Setting

GVRP

GVRP Global Setting:

1. GVRP: Click "GVRP" drop-down menu from "GVRP" drop-down list to choose "Enable" or "Disable" to enable or disable GVRP (GARP VLAN Registration Protocol).

2. Dynamic VLAN creation: Click “Dynamic VLAN creation” drop-down menu from “Dynamic VLAN creation” drop-down list to choose “Enable” or “Disable” to enable or disable Dynamic VLAN creation. GARP (Generic Attribute Registration Protocol) provides IEEE802.1Q compliant VLAN pruning and dynamic VLAN creation on IEEE802.1Q trunk ports.
3. Update Setting: Click “Update Setting” button when you finished GVRP Global Setting.

Per port setting (include LAG):

1. GVRP: Click “GVRP” drop-down menu from “GVRP” drop-down list to choose “Enable” or “Disable” to enable or disable GVRP for the port.
2. GVRP applicant: Click “GVRP applicant” drop-down menu from “GVRP applicant” drop-down list to choose “Active” or “Normal” to the port. Ports in the GVRP active applicant state send GVRP VLAN declarations when they are in the STP (Spanning Tree Protocol) blocking state, which prevents the STP bridge protocol data units (BPDUs) from being pruned from the other port. Ports in the GVRP normal applicant state do not declare GVRP VLANs when in the STP blocking state.
3. GVRP registration: Click “GVRP registration” drop-down menu from “GVRP registration” drop-down list to choose “Enable” or “Disable” to enable or disable GVRP registration to the port. Configuring an IEEE802.1Q trunk port in registration mode allows dynamic creation (if dynamic VLAN creation is enabled), registration, and deregistration of VLANs on the trunk port.
4. Update Setting: Click “Update Setting” button when you finished Per port setting.

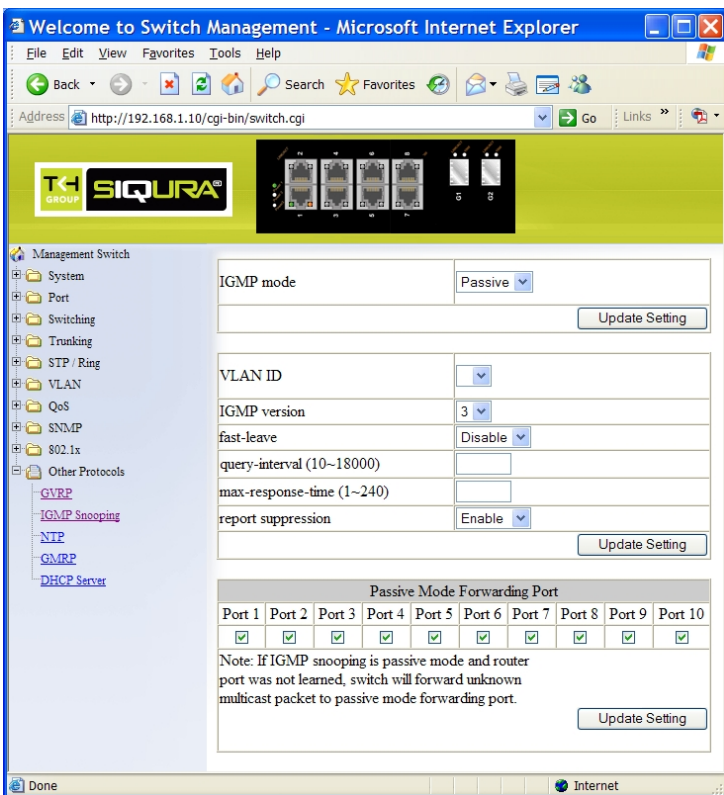

IGMP Snooping

1. IGMP mode: Click "IGMP mode" drop-down menu from "IGMP mode" drop-down list to choose "Disable", "Passive", or "querier" for the switch. Disable: Disable IGMP on the switch. Passive: The switch with only multicast-data-forwarding capability. Querier: The switch acts as the querier for the network. There is only one querier on a network at any time.
2. Update Setting: Click "Update Setting" button when you finished IGMP mode settings.
3. VLAN ID: Click "VLAN ID" drop-down menu from "VLAN ID" drop-down list to choose the VLAN under configuration for the switch.
4. IGMP version: Click "IGMP version" drop-down menu from "IGMP version" drop-down list to choose "1", "2", or "3" for the switch.
5. Fast-leave: Click "fast-leave" drop-down menu from "fast-leave" drop-down list to choose "Enable" or "Disable" for the switch. Enable this

function will allow members of a multicast group to leave the group immediately when an IGMP Leave Report Packet is received by the Switch.

IGMP querier:

1. Query-interval: Click in the “query-interval” textbox and specify a new number from 1 ~ 18000. The query-interval field is used to set the time (in seconds) between transmitting IGMP queries. Entries between 1 and 18000 seconds are allowed. Default = 125.
2. Max-response-time: Click in the “max-response-time” textbox and specify a new number from 1 ~ 124. This determines the maximum amount of time in seconds allowed before sending an IGMP response report. The max-response-time field allows an entry between 1 and 124 (seconds). Default = 10.

IGMP passive snooping:

1. Report suppression: Click “report suppression” drop-down menu from “report suppression” drop-down list to choose “Enable” or “Disable” for the switch. Use this command to enable report suppression for IGMP version 1 and version 2. Report suppression does not apply to IGMP version 3, and is turned off by default for IGMP version 1 and IGMP version 2 reports. The switch uses IGMP report suppression to forward only one IGMP report per multicast router query to multicast devices. When IGMP router suppression is enabled, the switch sends the first IGMP report from all hosts for a group to all the multicast routers. The switch does not send the remaining IGMP reports for the group to the multicast routers. This feature prevents duplicate reports from being sent to the multicast devices.
2. Update Setting: Click “Update Setting” button when you finished IGMP Snooping.

Passive Mode Forwarding Port:

1. Port: Choose the port to set the port as passive mode forwarding port. The Switch (in IGMP passive mode) will forward unknown multicast packets to passive mode forwarding port before receiving IGMP query.
2. Update Setting: Click “Update Setting” button when you finished Passive Mode Forwarding Port setting.

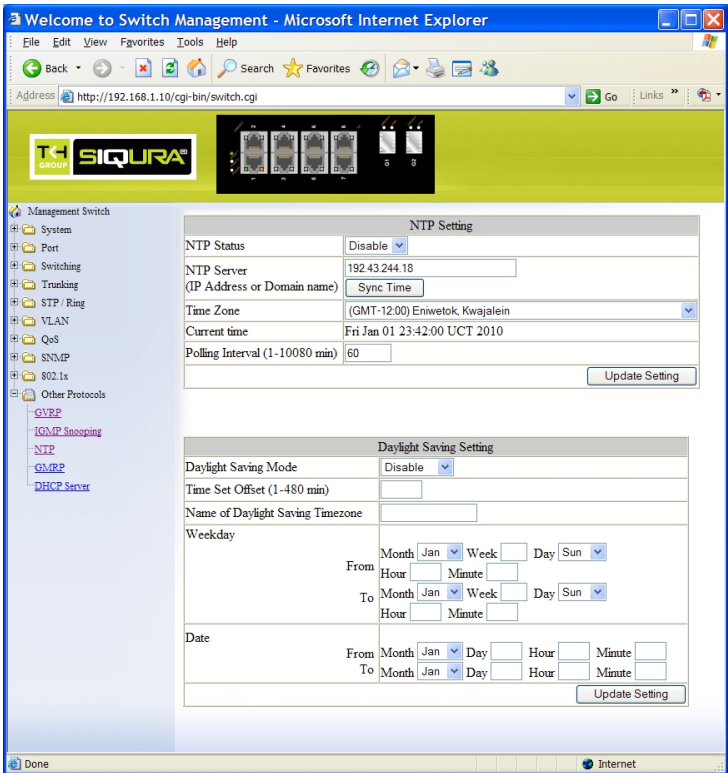

NTP

NTP Setting:

1. NTP Status: Click “NTP Status” drop-down menu from “NTP Status” drop-down list to choose “Enable” or “Disable” to enable or disable NTP for the Switch.
2. NTP Server (IP Address or Domain name): Click in the “NTP Server” textbox and specify the IP address or Domain name of NTP server.
3. Sync Time: Click “Sync Time” button to synchronize time with NTP server.
4. Time Zone: Click “Time Zone” drop-down menu from “Time Zone” drop-down list to set time zone.
5. Polling Interval (1-10080 min): Click in the “Polling Interval” textbox and specify the polling interval.
6. Update Setting: Click “Update Setting” button when you finished NTP Setting.

Daylight Saving Setting:

1. Daylight Saving Mode: Click "Daylight Saving Mode" drop-down menu from "Daylight Saving Mode" drop-down list to choose "Disable", "Weekday", or "Date" to choose disable, weekday, or date daylight saving for the Switch.
2. Time Set Offset (1-1440 min): Click in the "Time Set Offset" textbox and specify the offset time of daylight saving. For example enter 60 for one hour offset.
3. Name of Daylight Saving Timezone: Click in the "Name of Daylight Saving Timezone" textbox and specify the daylight saving timezone. This can be any given name in 14-character alpha-numericals. Enter the Name of Daylight Saving Timezone using the following example:
 - EDT - East Daylight Saving Time Zone.
 - CDT - Central Daylight-Saving Time Zone.
 - MDT - Mountain Daylight-Saving Time Zone.
 - PDT - Pacific Daylight-Saving Time Zone.
 - ADT - Alaska Daylight-Saving Time Zone.
4. Weekday: Specify the daylight saving period.
 - Month: Click "Month" drop-down menu from "Month" drop-down list to choose from January to December.
 - Week: <1-5> Specifies starting/ending week of daylight savings time.
 - Day: Click "Day" drop-down menu from "Day" drop-down list to choose from Sunday to Saturday.
 - Hour: <0-23> Specifies from 0 to 23.
 - Minute: <0-59> Specifies from 0 to 59.
5. Date: Specify the daylight saving period.
 - Month: Click "Month" drop-down menu from "Month" drop-down list to choose from January to December.
 - Day: <1-31> Specifies from 1 to 31.
 - Hour: <0-23> Specifies from 0 to 23.
 - Minute: <0-59> Specifies from 0 to 59.
6. Update Setting: Click "Update Setting" button when you finished Daylight Saving Setting.

<Note> The "Week", "Hour", "Minute", and "Day" fields would not accept the alphabetic characters (Like Jan, Feb, sun, mon). They only accept the two digit numbers (0 through 9).

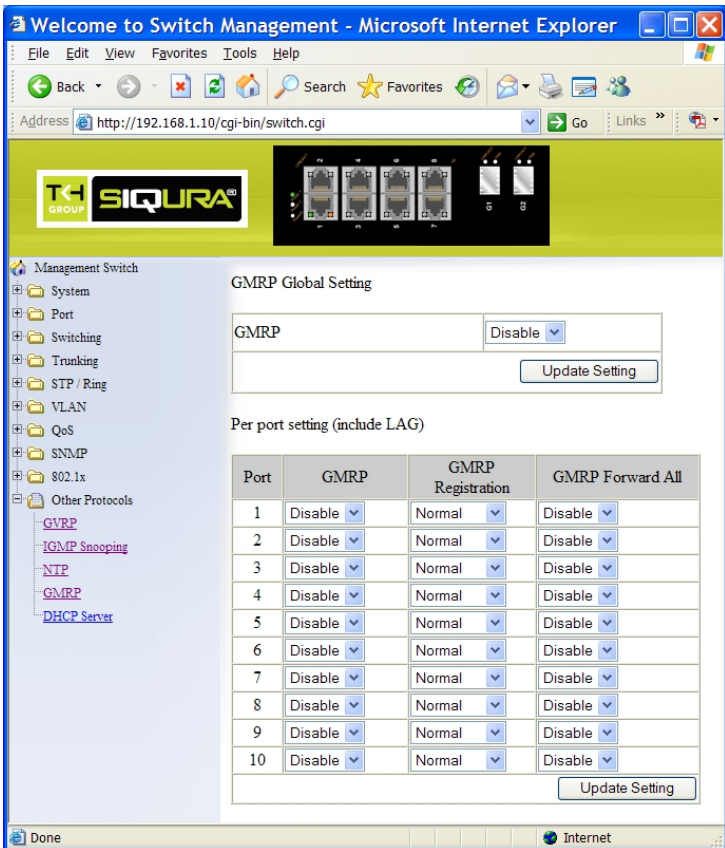

Management Switch

- System
- Port
- Switching
- Trunking
- STP / Ring
- VLAN
- QoS
- SNMP
- 802.1x
- Other Protocols
 - GMRP**
 - IGMP Snooping
 - NTP
 - GMRP
 - DHCP Server

GMRP Global Setting

GMRP:

Per port setting (include LAG)

| Port | GMRP | GMRP Registration | GMRP Forward All |
|------|---------|-------------------|------------------|
| 1 | Disable | Normal | Disable |
| 2 | Disable | Normal | Disable |
| 3 | Disable | Normal | Disable |
| 4 | Disable | Normal | Disable |
| 5 | Disable | Normal | Disable |
| 6 | Disable | Normal | Disable |
| 7 | Disable | Normal | Disable |
| 8 | Disable | Normal | Disable |
| 9 | Disable | Normal | Disable |
| 10 | Disable | Normal | Disable |

GMRP

GMRP Global Setting:

1. GMRP: Click “GMRP” drop-down menu from “GMRP” drop-down list to choose “Enable” or “Disable” to enable or disable GMRP.
2. Update Setting: Click “Update Setting” button when you finished GMRP Global Setting.

Per port setting (include LAG):

1. GMRP: Click “GMRP” drop-down menu from “GMRP” drop-down list to choose “Enable” or “Disable” to enable or disable GMRP for the port.
2. GMRP registration: Click “GMRP registration” drop-down menu from “GMRP registration” drop-down list to choose “Normal”, “Fixed” or “Forbidden” to specify GMRP registration to the port.

Normal specifies dynamic GMRP multicast registration and deregistration on the port.

Fixed specifies the multicast groups currently registered on the switch are applied to the port, but any subsequent registrations or deregistrations do not affect the port. Any registered multicast groups on the port are not deregistered based on the GARP timers.

Forbidden specifies that all GMRP multicasts are deregistered, and prevent any further GMRP multicast registration on the port.

3. GMRP Forward All: Click "GMRP Forward All" drop-down menu from "GMRP Forward All" drop-down list to choose "Enable" or "Disable" to enable or disable GMRP forwarding to the port.
4. Update Setting: Click "Update Setting" button when you finished Per port setting.

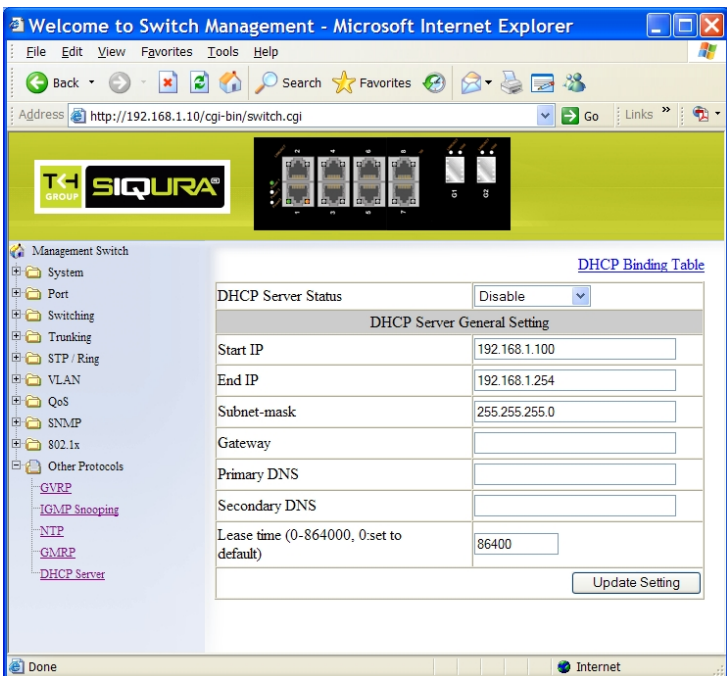

Management Switch

- System
- Port
- Switching
- Trunking
- STP / Ring
- VLAN
- QoS
- SNMP
- 802.1x
- Other Protocols
 - GVRP
 - IGMP Snooping
 - NTP
 - GMRP
 - DHCP Server

[DHCP Binding Table](#)

| | |
|---|---------------|
| DHCP Server Status | Disable |
| DHCP Server General Setting | |
| Start IP | 192.168.1.100 |
| End IP | 192.168.1.254 |
| Subnet-mask | 255.255.255.0 |
| Gateway | |
| Primary DNS | |
| Secondary DNS | |
| Lease time (0-864000, 0:set to default) | 86400 |

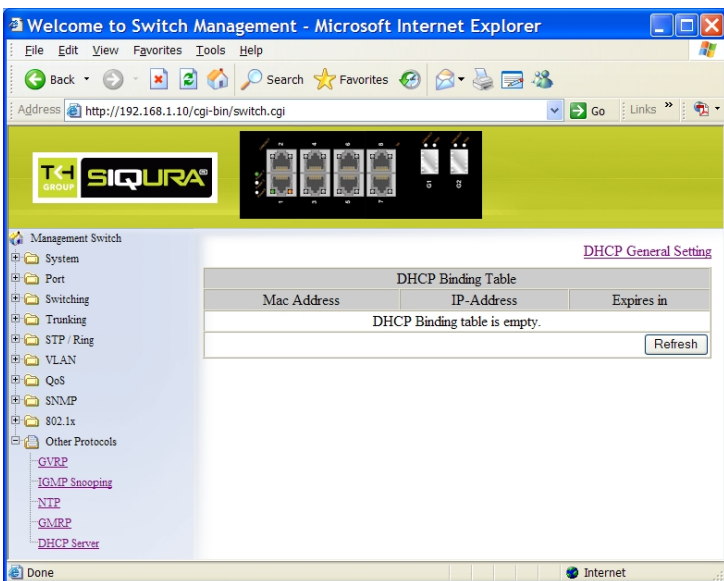

DHCP Server

1. DHCP Binding Table: Click on “DHCP Binding Table” to show DHCP Binding Table. Click “Refresh” button to refresh DHCP Binding Table. Click on “DHCP General Setting” to back to DHCP General Setting.
2. DHCP Server Status: Click “DHCP Server Status” drop-down menu from “DHCP Server Status” drop-down list to choose “Disable”, “Default VLAN 1”, or other VLAN.
3. Start IP: Click in the “Start IP” textbox and specify the default Start IP for the DHCP Server.
4. End IP: Click in the “End IP” textbox and specify the default End IP for the DHCP Server.
5. Subnet-mask: Click in the “Subnet-mask” textbox and specify the default subnet mask for the DHCP Server.
6. Gateway: Click in the “Gateway” textbox and specify the default gateway for the DHCP Server.
7. Primary DNS: Click in the “Primary DNS” textbox and specify the default primary DNS for the DHCP Server.
8. Secondary DNS: Click in the “Secondary DNS” textbox and specify the default secondary DNS for the DHCP Server.
9. Lease time: Click in the “Lease time” textbox and specify the default lease time for the DHCP Server.
10. Update Setting: Click “Update Setting” button when you finished DHCP Server General Setting.

<Note> Please disable and re-enable DHCP Server for any DHCP Server related changes to take effect.

Command Line Console Management

The switch provides a command line console interface for configuration purposes. The switch can be configured either locally through its RS-232 port or remotely via a Telnet session. For the later, you must specify an IP address for the switch first.

This chapter describes how to configure the switch using its console by Command Line.

Administration Console

Connect the DB9 straight cable to the RS-232 serial port of the device to the RS-232 serial port of the terminal or computer running the terminal emulation application.

Direct access to the administration console is achieved by directly connecting a terminal or a PC equipped with a terminal-emulation program (such as HyperTerminal) to the switch console port.

When using the management method, configure the terminal-emulation program to use the following parameters (you can change these settings after login):

[Default parameters]

115,200bps

8 data bits

No parity

1 stop bit

Exec Mode (View Mode)

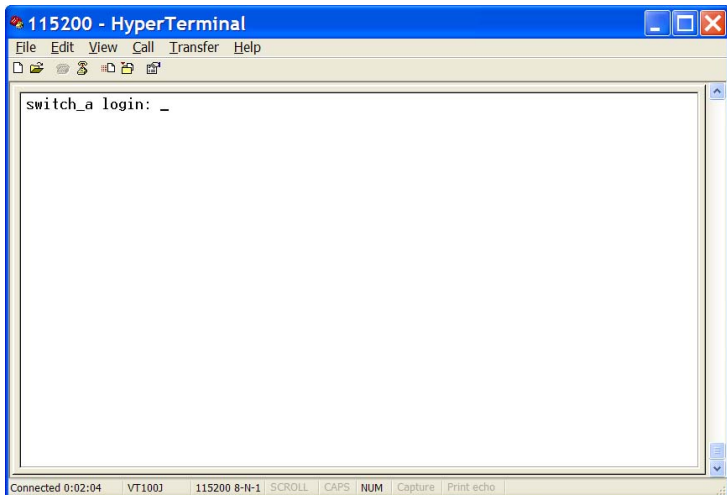

Logon to Exec Mode (View Mode)

At the **switch_a login:** prompt just type in "root" and press <Enter> to logon to Exec Mode (or View Mode).

switch_a login: root

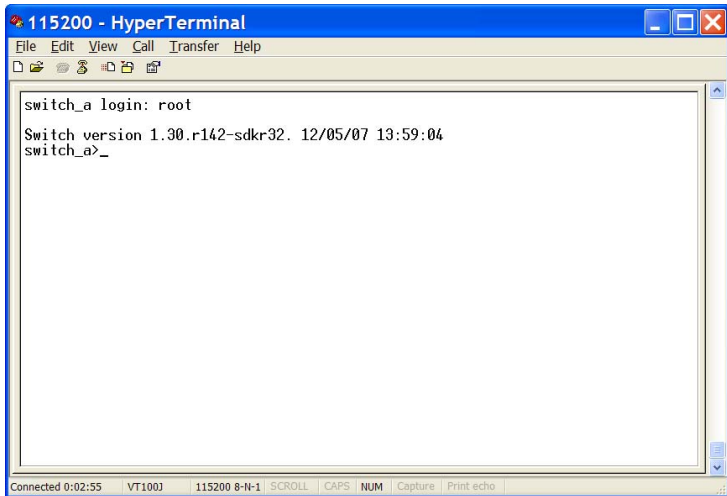

Basic commands

Exec Mode (or View Mode) is the base mode from where users can perform basic commands like:

clear, debug, disable, enable, exit, help, logout, no, quit, show, terminal

The CLI contains a text-based help facility. Access this help by typing in the full or partial command string then typing a question mark "?". The CLI displays the command keywords or parameters along with a short description.

At the **switch_a>** prompt just press <?> to list the above basic commands.

```
switch_a>?
```

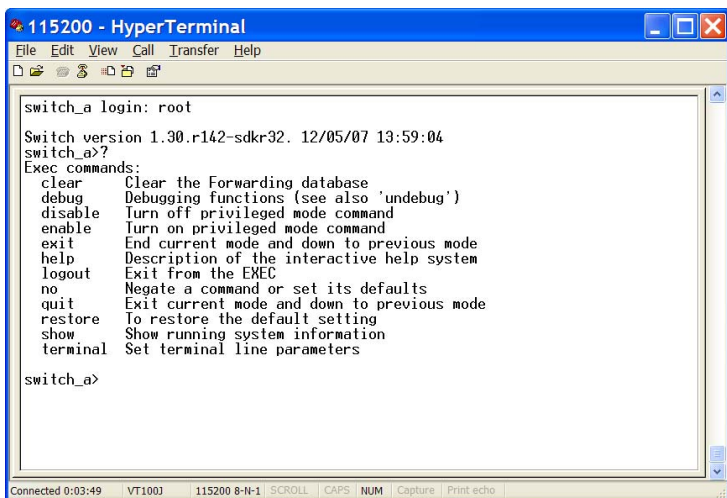

```

115200 - HyperTerminal
File Edit View Call Transfer Help
switch_a login: root
Switch version 1.30.r142-sdkr32. 12/05/07 13:59:04
switch_a>?
Exec commands:
clear      Clear the Forwarding database
debug      Debugging functions (see also 'undebug')
disable    Turn off privileged mode command
enable     Turn on privileged mode command
exit       End current mode and down to previous mode
help       Description of the interactive help system
logout     Exit from the EXEC
no         Negate a command or set its defaults
quit       Exit current mode and down to previous mode
restore    To restore the default setting
show       Show running system information
terminal   Set terminal line parameters

switch_a>

```

At the **switch_a>** prompt just type in the full or partial command string then typing a question mark "?" to display the command keywords or parameters along with a short description.

```
switch_a>show ?
```

```

115200 - HyperTerminal
File Edit View Call Transfer Help
switch_a>show ?
all-if          all-if
brand           Brand ID
bridge         bridge protocol
cli            Show CLI tree of current mode
debugging      Debugging functions (see also 'undebug')
etherchannel   LACP channel commands
flowcontrol    IEEE 802.3x Flow Control
gmrp           Generic Attribute Registration Protocol
gvrp           GARP Vlan Registration Protocol
hardware       Hardware configuration
history        Display the session command history
interface      The layer2 interfaces
ip             Internet Protocol (IP)
lACP           LACP commands
lACP-counter   LACP commands
list           Show command lists
mac            Mac address
mirror         Port Mirroring
mls            Switch(L2).
port           port commands
privilege      Show current privilege level
--More--

```

Connected 0:05:08 | VT100J | 115200 8-N-1 | SCROLL | CAPS | NUM | Capture | Print echo

```

115200 - HyperTerminal
File Edit View Call Transfer Help
gvrp           GARP Vlan Registration Protocol
hardware       Hardware configuration
history        Display the session command history
interface      The layer2 interfaces
ip             Internet Protocol (IP)
lACP           LACP commands
lACP-counter   LACP commands
list           Show command lists
mac            Mac address
mirror         Port Mirroring
mls            Switch(L2).
port           port commands
privilege      Show current privilege level
ratecontrol    The layer2 interface
spanning-tree  Display spanning-tree information
static-channel-group Static channel commands
storm-control  The layer2 interface
user-priority  Display the default user priority associated with the
               layer2 interface
users          Display information about terminal lines
version        Display version
vlan           Display VLAN information

switch_a>show

```

Connected 0:05:59 | VT100J | 115200 8-N-1 | SCROLL | CAPS | NUM | Capture | Print echo

Login timed out

The login session to Exec Mode (or View Mode) has timed out due to an extended period of inactivity (60 seconds) to indicate authentication attempt timed out. And the **switch_a login:** prompt will show on the screen.

Logon back to Exec Mode (View Mode)

At the **switch_a login:** prompt just type in “root” and press <Enter> to logon back to Exec Mode (or View Mode).

```
switch_a login: root
```

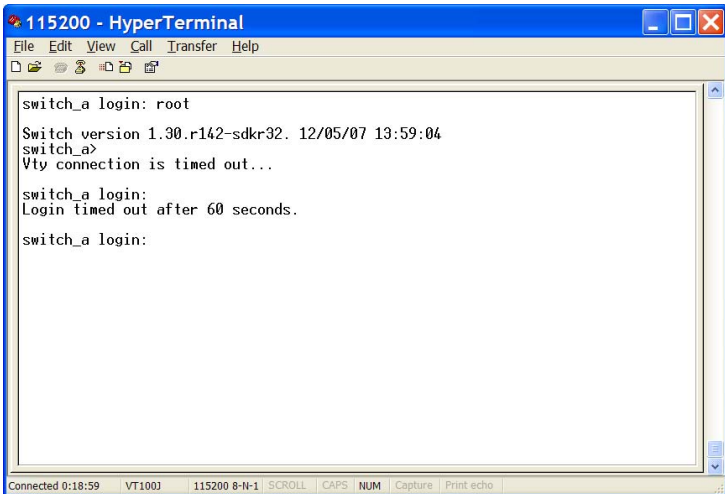

```
115200 - HyperTerminal
File Edit View Call Transfer Help
switch_a login: root
Switch version 1.30.r142-sdkr32. 12/05/07 13:59:04
switch_a>
Vty connection is timed out...
switch_a login:
Login timed out after 60 seconds.
switch_a login:
Connected 0:18:59 VT100J 115200 8-N-1 | SCROLL | CAPS | NUM | Capture | Print echo
```

Exit from Exec Mode (View Mode)

At the **switch_a>** prompt just type in “exit” and press <Enter> to exit from Exec Mode (or View Mode).

```
switch_a>exit
```

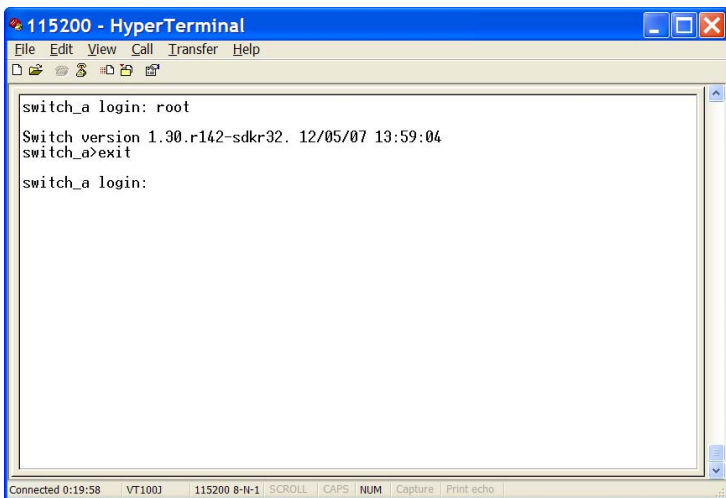

```
115200 - HyperTerminal
File Edit View Call Transfer Help
switch_a login: root
Switch version 1.30.r142-sdkr32. 12/05/07 13:59:04
switch_a>exit
switch_a login:
Connected 0:19:58 | VT100J | 115200 8-N-1 | SCROLL | CAPS | NUM | Capture | Print echo
```

Privileged Exec Mode (Enable Mode)

Logon to Privileged Exec Mode (Enable Mode)

At the **switch_a>** prompt just type in “enable” and press <Enter> to logon to Privileged Exec Mode (or Enable Mode). And the **switch_a#** prompt will show on the screen.

```
switch_a>enable
```

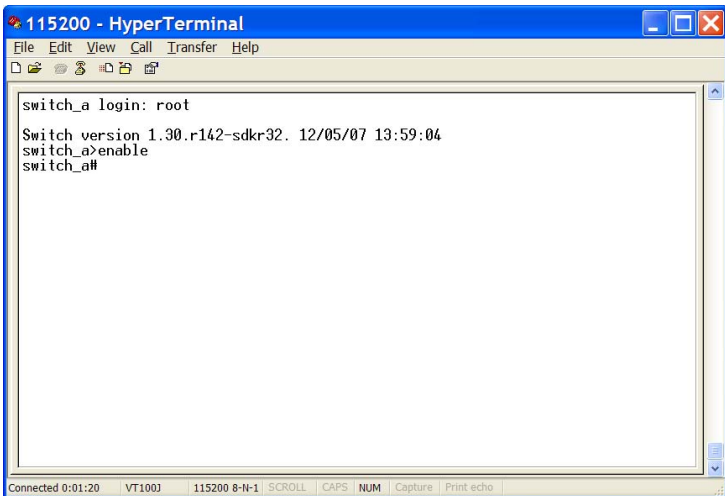

```

115200 - HyperTerminal
File Edit View Call Transfer Help
switch_a login: root
Switch version 1.30.r142-sdkr32. 12/05/07 13:59:04
switch_a>enable
switch_a#

```

Connected 0:01:20 VT100J 115200 8-N-1 SCROLL CAPS NUM Capture Print echo

Commands

Privileged Exec Mode (or Enable Mode) allows users to run commands as following.

At the **switch_a#** prompt just press <?> to list the commands.

```
switch_a#?
```

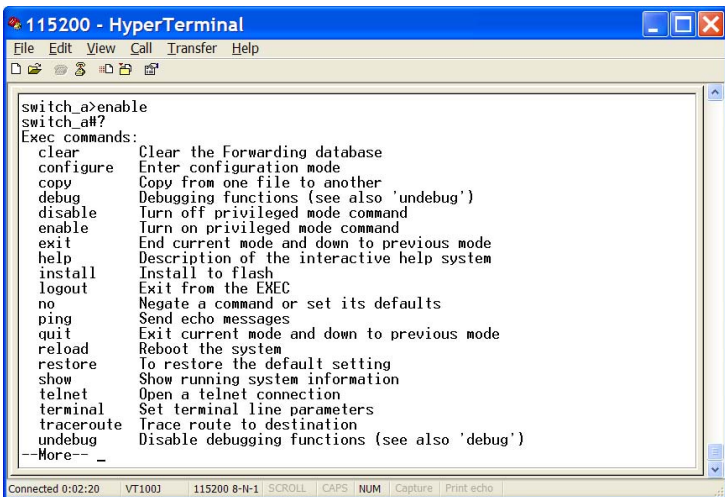

```

115200 - HyperTerminal
File Edit View Call Transfer Help
switch_a>enable
switch_a#?
Exec commands:
clear      Clear the Forwarding database
configure  Enter configuration mode
copy       Copy from one file to another
debug      Debugging functions (see also 'undebug')
disable    Turn off privileged mode command
enable     Turn on privileged mode command
exit       End current mode and down to previous mode
help       Description of the interactive help system
install    Install to flash
logout     Exit from the EXEC
no         Negate a command or set its defaults
ping       Send echo messages
quit       Exit current mode and down to previous mode
reload     Reboot the system
restore    To restore the default setting
show       Show running system information
telnet     Open a telnet connection
terminal   Set terminal line parameters
traceroute Trace route to destination
undebug    Disable debugging functions (see also 'debug')
--More--

```

Connected 0:02:20 VT100J 115200 8-N-1 SCROLL CAPS NUM Capture Print echo

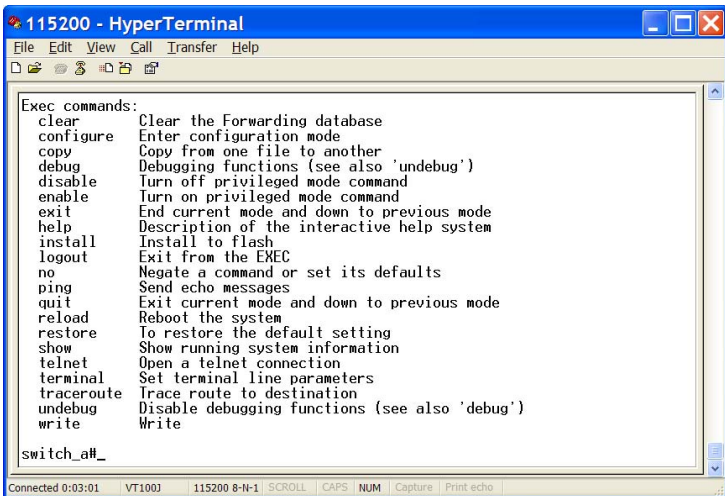

```

115200 - HyperTerminal
File Edit View Call Transfer Help
Exec commands:
clear      Clear the Forwarding database
configure  Enter configuration mode
copy       Copy from one file to another
debug      Debugging functions (see also 'undebug')
disable    Turn off privileged mode command
enable     Turn on privileged mode command
exit       End current mode and down to previous mode
help       Description of the interactive help system
install    Install to flash
logout     Exit from the EXEC
no         Negate a command or set its defaults
ping       Send echo messages
quit       Exit current mode and down to previous mode
reload     Reboot the system
restore    To restore the default setting
show       Show running system information
telnet     Open a telnet connection
terminal   Set terminal line parameters
traceroute Trace route to destination
undebug    Disable debugging functions (see also 'debug')
write     Write

switch_a#_
Connected 0:03:01 VT100J 115200 8-N-1 SCROLL CAPS NUM Capture Print echo

```

At the **switch_a#** prompt just type in the full or partial command string then typing a question mark “?” to display the command keywords or parameters along with a short description.

```
switch_a#show ?
```

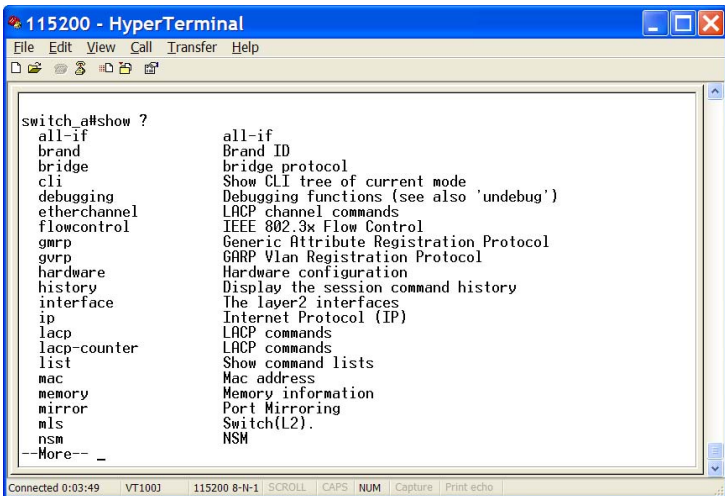

```

115200 - HyperTerminal
File Edit View Call Transfer Help
switch_a#show ?
all-if      all-if
brand       Brand ID
bridge      bridge protocol
cli         Show CLI tree of current mode
debugging   Debugging functions (see also 'undebug')
etherchannel LACP channel commands
flowcontrol IEEE 802.3x Flow Control
gmrp        Generic Attribute Registration Protocol
gvrp        GARP Vlan Registration Protocol
hardware    Hardware configuration
history     Display the session command history
interface   The layer2 interfaces
ip          Internet Protocol (IP)
lACP        LACP commands
lACP-counter LACP commands
list        Show command lists
mac         Mac address
memory      Memory information
mirror      Port Mirroring
mls         Switch(L2).
nsm         NSM
--More--
Connected 0:03:49 VT100J 115200 8-N-1 SCROLL CAPS NUM Capture Print echo

```

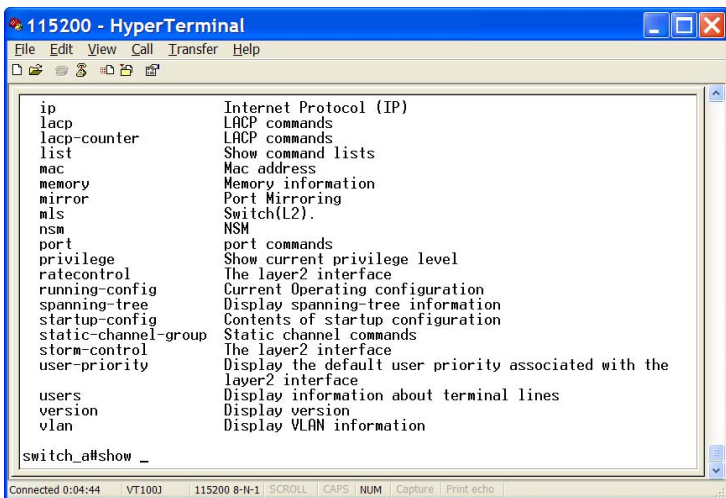
Login timed out

The login session to Privileged Exec Mode (or Enable Mode) has timed out due to an extended period of inactivity (60 seconds) to indicate authentication attempt timed out. And the **switch_a login:** prompt will show on the screen.

Logon back to Exec Mode (View Mode)

At the **switch_a login:** prompt just type in "root" and press <Enter> to logon back to Exec Mode (or View Mode).

```
switch_a login: root
```

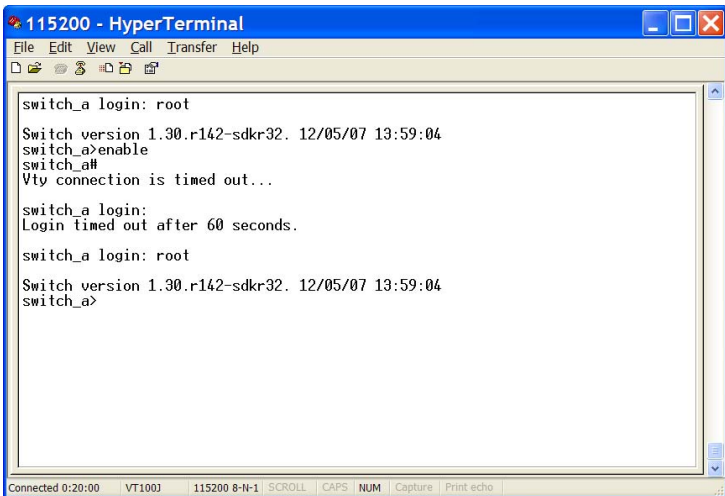

```

switch_a login: root
Switch version 1.30.r142-sdkr32. 12/05/07 13:59:04
switch_a>enable
switch_a#
Vty connection is timed out...

switch_a login:
Login timed out after 60 seconds.

switch_a login: root
Switch version 1.30.r142-sdkr32. 12/05/07 13:59:04
switch_a>

```

Connected 0:20:00 | VT100J | 115200 8-N-1 | SCROLL | CAPS | NUM | Capture | Print echo

Exit from Privileged Exec Mode (or Enable Mode)

At the **switch_a#** prompt just type in “exit” and press <Enter> to exit from Privileged Exec Mode (or Enable Mode).

```
switch_a#exit
```

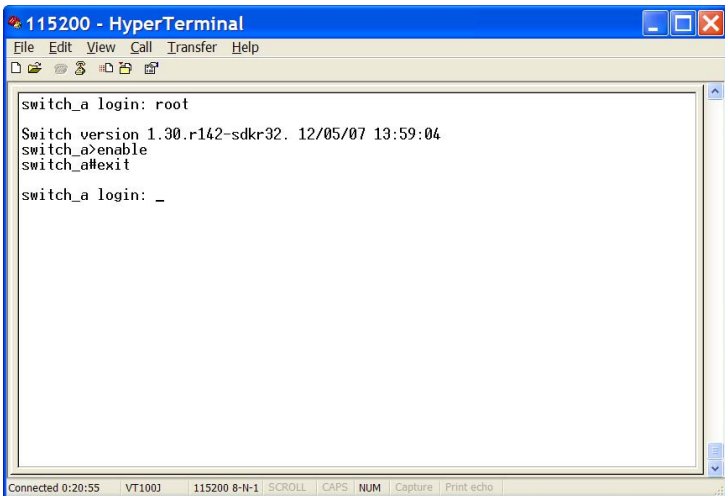

```

switch_a login: root
Switch version 1.30.r142-sdkr32. 12/05/07 13:59:04
switch_a>enable
switch_a#exit
switch_a login: _

```

Connected 0:20:55 | VT100J | 115200 8-N-1 | SCROLL | CAPS | NUM | Capture | Print echo

Configure Mode (Configure Terminal Mode)

Logon to Configure Mode (Configure Terminal Mode)

At the **switch_a#** prompt just type in “configure terminal” and press <Enter> to logon to Configure Mode (or Configure Terminal Mode). And the **switch_a(config)#** prompt will show on the screen.

```
switch_a#configure terminal
```

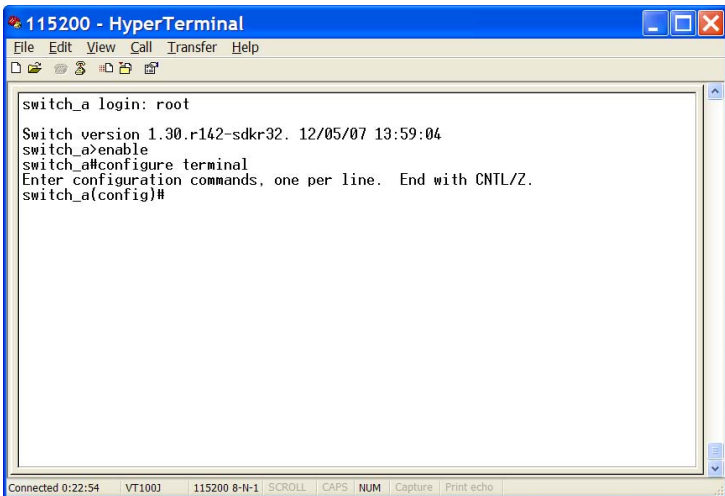

The screenshot shows a HyperTerminal window titled "115200 - HyperTerminal". The window contains the following text:

```
switch_a login: root
Switch version 1.30.r142-sdkr32. 12/05/07 13:59:04
switch_a>enable
switch_a#configure terminal
Enter configuration commands, one per line. End with CNTL/Z.
switch_a(config)#
```

The status bar at the bottom of the window displays: "Connected 0:22:54 VT100J 115200 8-N-1 | SCROLL | CAPS | NUM | Capture | Print echo |".

Commands

Configure Mode (or Configure Terminal Mode) serves as a gateway into the modes as following.

At the **switch_a(config)#** prompt just press <?> to list the commands.

```
switch_a(config)#?
```

```

115200 - HyperTerminal
File Edit View Call Transfer Help
Enter configuration commands, one per line. End with CNTL/Z.
switch_a(config)#?
Configure commands:
  banner      Define a login banner
  bridge      Bridge group commands.
  debug       Debugging functions (see also 'undebug')
  do          To run exec commands in config mode
  enable      Modify enable password parameters
  exit        End current mode and down to previous mode
  help        Description of the interactive help system
  hostname    Set system's network name
  interface   Select an interface to configure
  ip          Internet Protocol (IP)
  lacp        LACP commands
  line        Configure a terminal line
  log         Logging control
  mls         Switch(L2).
  no          Negate a command or set its defaults
  priority-queue Enable the egress expedite queue
  service     Set up miscellaneous service
  set         Set GMRP Registration to Fixed Registration
  show        Show running system information
  snmp-server Configure snmp setting
--More-- _
Connected 0:23:38  VT100J  115200 8-N-1  SCROLL | CAPS | NUM | Capture | Print echo

```

```

115200 - HyperTerminal
File Edit View Call Transfer Help
bridge      Bridge group commands.
debug       Debugging functions (see also 'undebug')
do          To run exec commands in config mode
enable      Modify enable password parameters
exit        End current mode and down to previous mode
help        Description of the interactive help system
hostname    Set system's network name
interface   Select an interface to configure
ip          Internet Protocol (IP)
lacp        LACP commands
line        Configure a terminal line
log         Logging control
mls         Switch(L2).
no          Negate a command or set its defaults
priority-queue Enable the egress expedite queue
service     Set up miscellaneous service
set         Set GMRP Registration to Fixed Registration
show        Show running system information
snmp-server Configure snmp setting
username    Establish User Name Authentication
vlan        Configure VLAN parameters
wrr-queue   WRR queue

switch_a(config)#_
Connected 0:24:15  VT100J  115200 8-N-1  SCROLL | CAPS | NUM | Capture | Print echo

```

At the **switch_a(config)#** prompt just type in the full or partial command string then typing a question mark “?” to display the command keywords or parameters along with a short description.

```
switch_a(config)#show ?
```

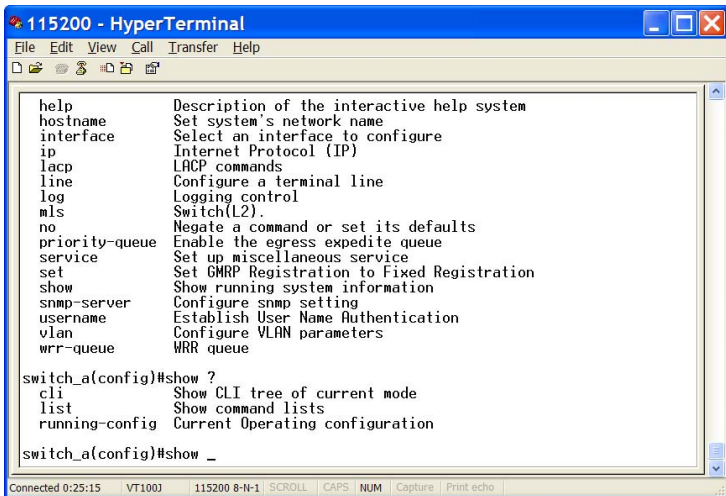

```
115200 - HyperTerminal
File Edit View Call Transfer Help
help      Description of the interactive help system
hostname  Set system's network name
interface Select an interface to configure
ip        Internet Protocol (IP)
lACP      LACP commands
line      Configure a terminal line
log       Logging control
mls       Switch(L2).
no        Negate a command or set its defaults
priority-queue Enable the egress expedite queue
service  Set up miscellaneous service
set       Set GMRP Registration to Fixed Registration
show     Show running system information
snmp-server Configure snmp setting
username Establish User Name Authentication
vlan     Configure VLAN parameters
wrr-queue WRR queue

switch_a(config)#show ?
cli      Show CLI tree of current mode
list     Show command lists
running-config Current Operating configuration

switch_a(config)#show _

Connected 0:25:15 | VT100J | 115200 8-N-1 | SCROLL | CAPS | NUM | Capture | Print echo
```

Login timed out

The login session to Configure Mode (or Configure Terminal Mode) has timed out due to an extended period of inactivity (60 seconds) to indicate authentication attempt timed out. And the **switch_a login:** prompt will show on the screen.

Logon back to Exec Mode (View Mode)

At the **switch_a login:** prompt just type in "root" and press <Enter> to logon back to Exec Mode (or View Mode).

```
switch_a login: root
```

```

115200 - HyperTerminal
File Edit View Call Transfer Help
switch_a login: root

Switch version 1.30.r142-sdkr32. 12/05/07 13:59:04
switch_a>enable
switch_a#configure terminal
Enter configuration commands, one per line. End with CNTL/Z.
switch_a(config)#
Vty connection is timed out...

switch_a login:
Login timed out after 60 seconds.

switch_a login: root

Switch version 1.30.r142-sdkr32. 12/05/07 13:59:04
switch_a>
    
```

Connected 0:38:30 VT100J 115200 8-N-1 SCROLL CAPS NUM Capture Print echo

Exit from Configure Mode (or Configure Terminal Mode)

At the **switch_a(config)#** prompt just type in “exit” and press <Enter> to exit from Configure Mode (or Configure Terminal Mode).

```
switch_a(config)#exit
```

```

115200 - HyperTerminal
File Edit View Call Transfer Help
switch_a login: root

Switch version 1.30.r142-sdkr32. 12/05/07 13:59:04
switch_a>enable
switch_a#configure terminal
Enter configuration commands, one per line. End with CNTL/Z.
switch_a(config)#exit
switch_a#_
    
```

Connected 0:40:23 VT100J 115200 8-N-1 SCROLL CAPS NUM Capture Print echo

User Interface Configuration

Http Server, Http Secure-Server, Telnet, SSH

Http Server

1. Command Mode: Configure mode

Logon to Configure Mode (Configure Terminal Mode).

The **switch_a(config)#** prompt will show on the screen.

```
switch_a(config)#
```

2. Usage:

Use **ip http server** command to enable the web server software of the Switch. User can remotely manage the Switch with a web browser from any management station on the network.

Use the **no ip http server** command to disable the web server software of the Switch.

3. Command Syntax:

(no) ip http server

4. Example:

The following example enables the web server software of the Switch:

```
switch_a(config)#ip http server
switch(config)#
```

Http Secure-Server

1. Command Mode: Configure mode

Logon to Configure Mode (Configure Terminal Mode).

The **switch_a(config)#** prompt will show on the screen.

```
switch_a(config)#
```

2. Usage:

Use **ip http secure-server** command to enable secure HTTP access. The Switch supports HTTPS to encrypt all HTTP traffic and access the web browser interface of the Switch via HTTPS.

Use the **no ip http secure-server** command to disable secure HTTP access.

3. Command Syntax:

(no) ip http secure-server

4. Example:

The following example enables secure HTTP access:

```
switch_a(config)#ip http secure-server
switch(config)#
```

Telnet

1. Command Mode: Configure mode
Logon to Configure Mode (Configure Terminal Mode).
The **switch_a(config)#** prompt will show on the screen.

```
switch_a(config)#
```

2. Usage:

Use **ip enable telnet** command to enable the Telnet server on the Switch. User can use Telnet to access the console utility of the Switch over a network.

Use the **no ip enable telnet** command to disable the Telnet server on the Switch.

3. Command Syntax:
(no) ip enable telnet

4. Example:

The following example enables the Telnet server on the Switch:

```
switch_a(config)#ip enable telnet
switch(config)#
```

SSH

1. Command Mode: Configure mode
Logon to Configure Mode (Configure Terminal Mode).
The **switch_a(config)#** prompt will show on the screen.

```
switch_a(config)#
```

2. Usage:

Use **ip enable ssh** command to enable SSH (Secure Shell) login to the Switch. User can use the SSH protocol for secure communication between a remote PC (the SSH Client) and the Switch (the SSH Server).

Use the **no ip enable ssh** command to disable SSH (Secure Shell) login to the Switch.

3. Command Syntax:
(no) ip enable ssh

4. Example:

The following example enables SSH (Secure Shell) login to the Switch:

```
switch_a(config)#ip enable ssh
switch(config)#
```

System

System Information, System Name/Password, IP Address, ARP Table, Route Table, Save Configuration, Firmware Upgrade, Alarm Setting, Reboot, Logout

System Name/Password

System Name:

1. Command Mode: Configure mode

Logon to Configure Mode (Configure Terminal Mode).

The **switch_a(config)#** prompt will show on the screen.

```
switch_a(config)#
```

2. Usage:

Use **hostname** command to set or change the network server name.

Use the **no hostname** command to disable this function.

3. Command Syntax:

(no) hostname HOSTNAME

HOSTNAME specifies the network name of the system.

4. Example:

The following example sets the hostname to **switch**, and shows the change in the prompt:

```
switch_a(config)#hostname switch
switch(config)#
```

Password:

1. Command Mode: Configure mode

Logon to Configure Mode (Configure Terminal Mode).

The **switch_a(config)#** prompt will show on the screen.

```
switch_a(config)#
```

2. Usage:

Use **enable password** command to modify or create a password to be used when entering the Enable mode.

3. Command Syntax:

enable password PASSWORD

PASSWORD specifies the new password of the system.

4. Example:

The following example sets the new password **mypasswd** to switch:

```
switch_a(config)#enable password mypasswd
switch_a(config)#
```

IP Address

IP Address/IP Subnet Mask:

1. Command Mode: Interface mode
Logon to Configure Mode (Configure Terminal Mode).
Then logon to Interface mode.

vlan1.1 means vlan 1.

The **switch_a(config-if)#** prompt will show on the screen.

```
switch_a(config)#interface vlan1.1
switch_a(config-if)#
```

2. Usage:

Use **ip address** command to set the IP address of an interface.

Use the **no ip address** command to remove the IP address from an interface.

3. Command Syntax:

```
ip address IP-ADDRESS
```

```
no ip address IP-ADDRESS
```

```
no ip address
```

IP-ADDRESS A.B.C.D/M specifies the IP address and prefix length of an interface.

M specifies IP subnet mask, 8: 255.0.0.0, 16:255.255.0.0, 24: 255.255.255.0.

4. Example:

The following example sets the new IP address **192.168.1.10** and new IP subnet mask **255.255.255.0** to switch:

```
switch_a(config)#interface vlan1.1
switch_a(config-if)#ip address 192.168.1.10/24
switch_a(config-if)#
```

DHCP Client:

1. Command Mode: Interface mode
Logon to Configure Mode (Configure Terminal Mode).
Then logon to Interface mode.

vlan1.1 means vlan 1.

The **switch_a(config-if)#** prompt will show on the screen.

```
switch_a(config)#interface vlan1.1
switch_a(config-if)#
```

2. Usage:

Use **get ip dhcp enable** command to get IP address through DHCP server.
Use the **no get ip dhcp enable** command to cancel the IP address which got through DHCP server.

3. Command Syntax:

(no) get ip dhcp enable

4. Example:

The following example gets IP address through DHCP server:

```
switch_a(config)#interface vlan1.1
switch_a(config-if)#get ip dhcp enable
switch_a(config-if)#
```

Default Gateway:

1. Command Mode: Configure mode

Logon to Configure Mode (Configure Terminal Mode).

The **switch_a(config)#** prompt will show on the screen.

```
switch_a(config)#
```

2. Usage:

Use **ip default-gateway** command to set the IP address of the default gateway.

Use the **no ip default-gateway** command to remove the IP address of the default gateway.

3. Command Syntax:

ip default-gateway IP-ADDRESS

no ip default-gateway

IP-ADDRESS A.B.C.D specifies the IP address of the default gateway.

4. Example:

The following example sets the default gateway **192.168.1.254** to switch:

```
switch_a(config)#ip default-gateway 192.168.1.254
switch_a(config)#
```

DNS Server:

1. Command Mode: Configure mode

Logon to Configure Mode (Configure Terminal Mode).

The **switch_a(config)#** prompt will show on the screen.

```
switch_a(config)#
```

2. Usage:

Use **ip dns** command to set the IP address of the DNS server.

Use the **no ip dns** command to remove the IP address of the DNS server.

3. Command Syntax:

```
ip dns IP-ADDRESS
```

```
no ip dns
```

IP-ADDRESS A.B.C.D specifies the IP address of the DNS server.

4. Example:

The following example sets the DNS server **192.168.1.100** to switch:

```
switch_a(config)#ip dns 192.168.1.100  
switch_a(config)#
```

ARP Table

1. Command Mode: Privileged Exec mode

Logon to Privileged Exec Mode (Enable Mode).

The **switch_a#** prompt will show on the screen.

```
switch_a#
```

2. Usage:

Use **show arp-table** command to view ARP Table.

3. Command Syntax:

```
show arp-table
```

4. Example:

The following example shows the ARP Table of switch:

```
switch_a#show arp-table
```

Route Table

1. Command Mode: Privileged Exec mode

Logon to Privileged Exec Mode (Enable Mode).

The **switch_a#** prompt will show on the screen.

```
switch_a#
```

2. Usage:

Use **show route-table** command to view Route Table.

3. Command Syntax:

```
show route-table
```

4. Example:

The following example shows the Route Table of switch:

```
switch_a#show route-table
```

Save Configuration

Load config from TFTP server:

1. Command Mode: Privileged Exec mode
Logon to Privileged Exec Mode (Enable Mode).
The **switch_a#** prompt will show on the screen.

```
switch_a#
```

2. Usage:

Use **install image** command to load configuration file from tftp server to switch.

3. Command Syntax:

install image IP-ADDRESS WORD

IP-ADDRESS specifies the IP address of tftp server.

WORD specifies the file name to be loaded to switch.

4. Example:

The following example specifies upgrading firmware (file name: **flash.tgz**) from tftp server (IP address: **192.168.1.100**) to switch:

```
switch_a#install image 192.168.1.100 flash.tgz
switch_a#
```

Load config to TFTP server:

1. Command Mode: Privileged Exec mode
Logon to Privileged Exec Mode (Enable Mode).
The **switch_a#** prompt will show on the screen.

```
switch_a#
```

2. Usage:

Use **write config-file** command to backup configuration file to tftp server.

3. Command Syntax:

write config-file IP-ADDRESS

IP-ADDRESS specifies the IP address of tftp server.

4. Example:

The following example backups configuration file to tftp server (IP address: **192.168.1.100**):

```
switch_a#write config-file 192.168.1.100
switch_a#
```

Save Configuration:

1. Command Mode: Privileged Exec mode
 Logon to Privileged Exec Mode (Enable Mode).
 The **switch_a#** prompt will show on the screen.

```
switch_a#
```

2. Usage:
 Use **copy running-config startup-config** command to write configurations to the file to be used at startup. This is the same as the **write memory** command.

3. Command Syntax:
 copy running-config startup-config

4. Example:
 The following example specifies writing configurations to the file to be used at startup to switch:

```
switch_a#copy running-config startup-config
switch_a#
```

Restore Default:

1. Command Mode: Privileged Exec mode
 Logon to Privileged Exec Mode (Enable Mode).
 The **switch_a#** prompt will show on the screen.

```
switch_a#
```

2. Usage:
 Use **restore default** command to restore default setting of the switch.

3. Command Syntax:
 restore default

4. Example:
 The following example restores default setting of the switch:

```
switch_a#restore default
switch_a#
```

Auto Save:

1. Command Mode: Configure mode
 Logon to Configure Mode (Configure Terminal Mode).
 The **switch_a(config)#** prompt will show on the screen.

```
switch_a(config)#
```

2. Usage:
 Use this command to enable auto save configuration function. The

configuration will be automatically saved at every configured interval while this command is enabled. Use the no form of this command to disable this feature.

3. Command Syntax:

```
service auto-config enable  
no service auto-config enable
```

4. Example:

The following example enables or disables auto save configuration to switch:

```
switch_a(config)#service auto-config enable  
switch_a(config)#no service auto-config enable  
switch_a(config)#
```

Auto Save Interval (5~65536 sec):

1. Command Mode: Configure mode

Logon to Configure Mode (Configure Terminal Mode).

The **switch_a(config)#** prompt will show on the screen.

```
switch_a(config)#
```

2. Usage:

Use this command to set the interval when the configuration would be automatically saved. The range of interval value is from 5 to 65535. And the default value is 30 seconds.

3. Command Syntax:

```
service auto-config interval WORD  
WORD specifies the interval value.
```

4. Example:

The following example sets the interval WORD (**10**) when the configuration would be automatically saved to switch:

```
switch_a(config)#service auto-config interval 10  
switch_a(config)#
```

Firmware Upgrade

1. Command Mode: Privileged Exec mode

Logon to Privileged Exec Mode (Enable Mode).

The **switch_a#** prompt will show on the screen.

```
switch_a#
```

2. Usage:

Use **install image** command to upgrade firmware from tftp server to switch.

3. Command Syntax:

install image IP-ADDRESS WORD

IP-ADDRESS specifies the IP address of tftp server.

WORD specifies the file name to be upgraded to switch.

4. Example:

The following example specifies upgrading firmware (file name: **flash.tgz**) from tftp server (IP address: **192.168.1.100**) to switch:

```
switch_a#install image 192.168.1.100 flash.tgz
switch_a#
```

Please follow the message on the screen during the firmware upgrade process. Do not turn off the power or perform other functions during this period of time.

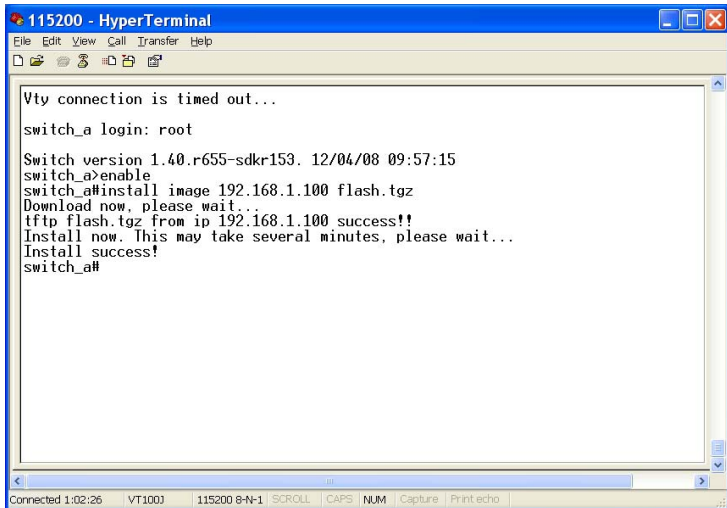

```

115200 - HyperTerminal
File Edit View Call Transfer Help
Vty connection is timed out...
switch_a login: root
Switch version 1.40.r655-sdkr153. 12/04/08 09:57:15
switch_a>enable
switch_a#install image 192.168.1.100 flash.tgz
Download now, please wait...
tftp flash.tgz from ip 192.168.1.100 success!!
Install now. This may take several minutes, please wait...
Install success!
switch_a#

```

Connected 1:02:26 VT100J 115200 8-N-1 SCROLL CAPS NUM Capture Print echo

At the “switch_a#” prompt just type in “reload” and press <Enter> to reboot the switch after completing the upgrade process.

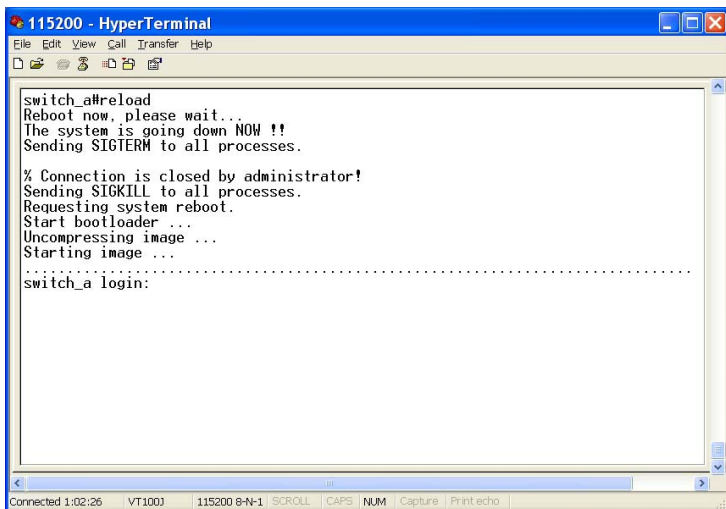

```

switch_a#reload
Reboot now, please wait...
The system is going down NOW !!
Sending SIGTERM to all processes.

% Connection is closed by administrator!
Sending SIGKILL to all processes.
Requesting system reboot.
Start bootloader ...
Uncompressing image ...
Starting image ...
.....
switch_a login:
  
```

Alarm Setting

Alarm-trigger if:

1. Command Mode: Configure mode

Logon to Configure Mode (Configure Terminal Mode).

The **switch_a(config)#** prompt will show on the screen.

```
switch_a(config)#
```

2. Usage:

Use this command to enable or disable alarm trigger on interface.

3. Command Syntax:

(no) alarm-trigger if INTERFACE

INTERFACE specifies the interface.

4. Example:

The following example enables alarm trigger on interface "fe1" to switch:

```
switch_a(config)#alarm-trigger if fe1
switch_a(config)#
```

Alarm-trigger power:

1. Command Mode: Configure mode

Logon to Configure Mode (Configure Terminal Mode).

The **switch_a(config)#** prompt will show on the screen.

```
switch_a(config)#
```

2. Usage:

Use this command to enable or disable alarm trigger of power source.

3. Command Syntax:

(no) alarm-trigger power POWER

POWER specifies the power source.

4. Example:

The following example enables alarm trigger of power "1" to switch:

```
switch_a(config)#alarm-trigger power 1
switch_a(config)#
```

Reboot

1. Command Mode: Privileged Exec mode

Logon to Privileged Exec Mode (Enable Mode).

The **switch_a#** prompt will show on the screen.

```
switch_a#
```

2. Usage:

Use **reload** command to restart switch.

3. Command Syntax:

reload

4. Example:

The following example specifies restarting switch:

```
switch_a#reload
switch_a login:
```

Logout

1. Command Mode: Exec mode or Privileged Exec mode

Logon to Exec Mode (View Mode) or Privileged Exec Mode (Enable Mode).

The **switch_a>** or **switch_a#** prompt will show on the screen.

```
switch_a>
```

```
switch_a#
```

2. Usage:

Use **logout** command to exit from the Exec mode or Privileged Exec mode.

3. Command Syntax:

logout

4. Example:

The following example specifies to exit from the Exec mode or Privileged Exec mode.

```
switch_a>logout  
switch_a login:
```

Port

Configuration, Port Status, Rate Control, RMON Statistics, Per Port Vlan Activities, Port Security

Configuration

Port Name:

1. Command Mode: Interface mode
Logon to Configure Mode (Configure Terminal Mode).
Then logon to Interface mode.

fe1 means port 1.

The **switch_a(config-if)#** prompt will show on the screen.

```
switch_a(config)#interface fe1
switch_a(config-if)#
```

2. Usage:

Use the **portname** command to specify the ascii name of port.
Use the **no portname** to cancel the ascii name of port.

3. Command Syntax:

portname LINE

(no) portname

LINE specifies the ascii name of port.

4. Example:

The following example shows the use of the **portname** command to specify the ascii name **fe1** for the interface fe1 (port 1):

```
switch_a(config)#interface fe1
switch_a(config-if)#portname fe1
switch_a(config-if)#
```

Admin Setting:

1. Command Mode: Interface mode
Logon to Configure Mode (Configure Terminal Mode).
Then logon to Interface mode.

fe1 means port 1.

The **switch_a(config-if)#** prompt will show on the screen.

```
switch_a(config)#interface fe1
switch_a(config-if)#
```

2. Usage:

Use the **shutdown** command to shut down the selected interface.
Use the **no shutdown** to disable this function.

3. Command Syntax:
(no) shutdown

4. Example:

The following example shows the use of the **shutdown** command to shut down the interface fe1 (port 1):

```
switch_a(config)#interface fe1
switch_a(config-if)#shutdown
switch_a(config-if)#
```

Bandwidth:

1. Command Mode: Interface mode

Logon to Configure Mode (Configure Terminal Mode).

Then logon to Interface mode.

fe1 means port 1.

The **switch_a(config-if)#** prompt will show on the screen.

```
switch_a(config)#interface fe1
switch_a(config-if)#
```

2. Usage:

Use this command to specify the bandwidth for each interface. The bandwidth value is in bits.

Use the no parameter with this command to remove the bandwidth for each interface.

3. Command Syntax:

Bandwidth BANDWIDTH

no bandwidth

BANDWIDTH

<1-10000000000 bits> (usable units: k, m, g)

<1-999>k|m for 1 to 999 kilo bits or mega bits.

1g for 1 giga bits.

4. Example:

The following example shows the use of bandwidth BANDWIDTH (**10 mega bits**) to the interface fe1 (port 1):

```
switch_a(config)#interface fe1
switch_a(config-if)#bandwidth 10m
switch_a(config-if)#
```

Duplex:

1. Command Mode: Interface mode

Logon to Configure Mode (Configure Terminal Mode).

Then logon to Interface mode.

fe1 means port 1.

The **switch_a(config-if)#** prompt will show on the screen.

```
switch_a(config)#interface fe1
switch_a(config-if)#
```

2. Usage:

Use **duplex** command to specify the duplex mode to be used for each interface.

Use the **no duplex** to disable this function.

3. Command Syntax:

(no) duplex MODE

MODE specifies the duplex mode: auto, full, half.

4. Example:

The following example shows the use of **duplex** MODE (**full**) to the interface fe1 (port 1):

```
switch_a(config)#interface fe1
switch_a(config-if)#duplex full
switch_a(config-if)#
```

Flow control:

1. Command Mode: Interface mode

Logon to Configure Mode (Configure Terminal Mode).

Then logon to Interface mode.

fe1 means port 1.

The **switch_a(config-if)#** prompt will show on the screen.

```
switch_a(config)#interface fe1
switch_a(config-if)#
```

2. Usage:

Use **flowcontrol on** command to enable flow control, and configure the flow control mode for the port.

Use the **no flowcontrol** to disable this function.

3. Command Syntax:

flowcontrol on

no flowcontrol

4. Example:

The following example shows the use of **flowcontrol on** to the interface fe1 (port 1):

```
switch_a(config)#interface fe1
switch_a(config-if)#flowcontrol on
switch_a(config-if)#
```

Port Status

1. Command Mode: Exec mode or Privileged Exec mode
 Logon to Exec Mode (View Mode) or Privileged Exec Mode (Enable Mode).
 The **switch_a>** or **switch_a#** prompt will show on the screen.

```
switch_a>
```

```
switch_a#
```

2. Usage:

Use the **show interface** command to display interface configuration and status.

3. Command Syntax:

show interface IFNAME

IFNAME specifies the name of the interface for which status and configuration information is desired.

4. Example:

The following example shows the use of **show interface** to display interface configuration and status of the interface fe1 (port 1):

```
switch_a>show interface fe1
```

Rate Control

1. Command Mode: Interface mode
 Logon to Configure Mode (Configure Terminal Mode).
 Then logon to Interface mode.

fe1 means port 1.

The **switch_a(config-if)#** prompt will show on the screen.

```
switch_a(config)#interface fe1
```

```
switch_a(config-if)#
```

2. Usage:

Use this command to specify the ingress/egress rate to be used for each interface. The bandwidth value is in bits.

Use the no parameter with this command to remove the ingress/egress rate to be used for each interface.

3. Command Syntax:

(no) rate-control ingress/egress VALUE

VALUE

<1-10000000000 bits> (usable units: k, m, g)

<1-999>k|m for 1 to 999 kilo bits or mega bits.

1g for 1 giga bits.

4. Example:

The following example shows the use of rate-control ingress VALUE (**10 mega bits**) to the interface fe1 (port 1):

```
switch_a(config)#interface fe1
switch_a(config-if)#rate-control ingress 10m
switch_a(config-if)#
```

RMON Statistics

1. Command Mode: Exec mode or Privileged Exec mode
 Logon to Exec Mode (View Mode) or Privileged Exec Mode (Enable Mode).
 The **switch_a>** or **switch_a#** prompt will show on the screen.

```
switch_a>
```

```
switch_a#
```

2. Usage:

Use the **show interface statistics** command to display RMON statistics of interface.

3. Command Syntax:

show interface statistics IFNAME

IFNAME specifies the name of the interface for which RMON statistics is desired.

4. Example:

The following example shows the use of **show interface statistics** to display RMON statistics of the interface fe1 (port 1):

```
switch_a>show interface statistics fe1
```

Per Port Vlan Activities

1. Command Mode: Exec mode or Privileged Exec mode
 Logon to Exec Mode (View Mode) or Privileged Exec Mode (Enable Mode).
 The **switch_a>** or **switch_a#** prompt will show on the screen.

```
switch_a>
```

```
switch_a#
```

2. Usage:

Use **show vlan** command to display information about a particular VLAN by specifying the VLAN ID.

3. Command Syntax:

show vlan <2-4094>

<2-4094> VLAN ID.

4. Example:

The following is an output of **show vlan** command displaying information about VLAN 2:

```
switch_a>show vlan 2
```

Port Security

Mode:

1. Command Mode: Interface mode
Logon to Configure Mode (Configure Terminal Mode).
Then logon to Interface mode.
fe1 means port 1.

The **switch_a(config-if)#** prompt will show on the screen.

```
switch_a(config)#interface fe1
switch_a(config-if)#
```

2. Usage:

Use **port-security enable** command to enable port security.
Use **no port-security enable** command to disable port security.

3. Command Syntax:

```
port-security enable
no port-security enable
```

4. Example:

The following example shows setting **port-security enable** to the interface fe1 (port 1):

```
switch_a(config)#interface fe1
switch_a(config-if)#port-security enable
switch_a(config-if)#
```

Add/Delete MAC Address:

1. Command Mode: Interface mode
Logon to Configure Mode (Configure Terminal Mode).
Then logon to Interface mode.
fe1 means port 1.

The **switch_a(config-if)#** prompt will show on the screen.

```
switch_a(config)#interface fe1
switch_a(config-if)#
```

2. Usage:

Use this command to add or delete MAC address allowed for the port.

3. Command Syntax:

port-security allowed-address MAC

no port-security allowed-address MAC

MAC the Media Access Control (MAC) address in the HHHH.HHHH.HHHH format.

4. Example:

The following example adds a MAC address **2222.2222.2222** allowed to the interface fe1 (port 1):

```
switch_a(config)#interface fe1
switch_a(config-if)#port-security allowed-address 2222.2222.2222
switch_a(config-if)#
```

Switching

Bridging, Static MAC Entry, Port Mirroring

Bridging

Aging Time (seconds):

1. Command Mode: Configure mode

Logon to Configure Mode (Configure Terminal Mode).

The **switch_a(config)#** prompt will show on the screen.

```
switch_a(config)#
```

2. Usage:

Use this command to specify an ageing-out time for a learned MAC address. The learned MAC address will persist till this specified time.

3. Command Syntax:

Bridge GROUP ageing-time AGEINGTIME

no bridge GROUP ageing-time

Group = <1-1> The ID of the bridge-group that this ageing time is for.

AGEINGTIME = <10-1000000> The number of seconds of persistence.

4. Example:

The following example sets the new AGEINGTIME (**1000**) to bridge GROUP (1):

```
switch_a(config)#bridge 1 ageing-time 1000  
switch_a(config)#
```

Threshold level (0-100):

1. Command Mode: Interface mode

Logon to Configure Mode (Configure Terminal Mode).

Then logon to Interface mode.

fe1 means port 1.

The **switch_a(config-if)#** prompt will show on the screen.

```
switch_a(config)#interface fe1  
switch_a(config-if)#
```

2. Usage:

Use **storm-control level** command to specify the rising threshold level for broadcasting, multicast, or destination lookup failure traffic. The storm control action occurs when traffic utilization reaches this level.

3. Command Syntax:

storm-control level LEVEL

LEVEL <0-100> specifies the percentage of the threshold; percentage of the maximum speed (pps) of the interface.

4. Example:

The following example shows setting **storm-control level LEVEL (30)** to the interface fe1 (port 1):

```
switch_a(config)#interface fe1
switch_a(config-if)#storm-control level 30
switch_a(config-if)#
```

Broadcast:

1. Command Mode: Interface mode
Logon to Configure Mode (Configure Terminal Mode).
Then logon to Interface mode.
fe1 means port 1.

The **switch_a(config-if)#** prompt will show on the screen.

```
switch_a(config)#interface fe1
switch_a(config-if)#
```

2. Usage:

Use **storm-control broadcast enable** command to enable broadcast traffic.
Use **no storm-control broadcast** command to disable broadcast traffic.

3. Command Syntax:

```
storm-control broadcast enable
no storm-control broadcast
```

4. Example:

The following example shows setting **storm-control broadcast enable** to the interface fe1 (port 1):

```
switch_a(config)#interface fe1
switch_a(config-if)#storm-control broadcast enable
switch_a(config-if)#
```

Multicast:

1. Command Mode: Interface mode
Logon to Configure Mode (Configure Terminal Mode).
Then logon to Interface mode.
fe1 means port 1.

The **switch_a(config-if)#** prompt will show on the screen.

```
switch_a(config)#interface fe1
switch_a(config-if)#
```

2. Usage:

Use **storm-control multicast enable** command to enable multicast traffic.
Use **no storm-control multicast** command to disable multicast traffic.

3. Command Syntax:
storm-control multicast enable
no storm-control multicast

4. Example:
The following example shows setting **storm-control multicast enable** to the interface fe1 (port 1):

```
switch_a(config)#interface fe1
switch_a(config-if)#storm-control multicast enable
switch_a(config-if)#
```

DLF:

1. Command Mode: Interface mode
Logon to Configure Mode (Configure Terminal Mode).
Then logon to Interface mode.
fe1 means port 1.

The **switch_a(config-if)#** prompt will show on the screen.

```
switch_a(config)#interface fe1
switch_a(config-if)#
```

2. Usage:

Use **storm-control dlf enable** command to enable destination lookup failure traffic.

Use **no storm-control dlf** command to disable destination lookup failure traffic.

3. Command Syntax:
storm-control dlf enable
no storm-control dlf
dlf destination lookup failure

4. Example:
The following example shows setting **storm-control dlf enable** to the interface fe1 (port 1):

```
switch_a(config)#interface fe1
switch_a(config-if)#storm-control dlf enable
switch_a(config-if)#
```

Static MAC Entry

Static-MAC-Entry Forward:

1. Command Mode: Configure mode

Logon to Configure Mode (Configure Terminal Mode).

The **switch_a(config)#** prompt will show on the screen.

```
switch_a(config)#
```

2. Usage:

Use this command to statically configure a bridge entry to forward matching frames.

3. Command Syntax:

bridge GROUP address MAC forward IFNAME VLANID

no bridge GROUP address MAC forward IFNAME VLANID

GROUP <1-1> Bridge-group ID used for bridging.

MAC the Media Access Control (MAC) address in the HHHH.HHHH.HHHH format.

IFNAME the interface on which the frame comes in.

VLANID The VID of the VLAN that will be enabled or disabled on the bridge <2-4094>.

4. Example:

The following example configures a bridge GROUP (1) to forward matching frames (MAC address **2222.2222.2222**) to the interface fe1 (port 1) in vlan VLANID (2):

```
switch_a(config)#bridge 1 address 2222.2222.2222 forward fe1 vlan 2
switch_a(config)#
```

Static-MAC-Entry Discard:

1. Command Mode: Configure mode

Logon to Configure Mode (Configure Terminal Mode).

The **switch_a(config)#** prompt will show on the screen.

```
switch_a(config)#
```

2. Usage:

Use this command to statically configure a bridge entry to discard matching frames in a particular VLAN.

3. Command Syntax:

bridge GROUP address MAC discard vlan VLANID

no bridge GROUP address MAC discard vlan VLANID

GROUP <1-1> Bridge-group ID used for bridging.

MAC the Media Access Control (MAC) address in the HHHH.HHHH.HHHH format.

VLANID The VID of the VLAN on the bridge <1-4094>.

4. Example:

The following example configures a bridge GROUP (1) to discard matching frames (MAC address **2222.2222.2222**) in vlan VLANID (1):

```
switch_a(config)#bridge 1 address 2222.2222.2222 discard vlan 1
switch_a(config)#
```

Port Mirroring

1. Command Mode: Interface mode
Logon to Configure Mode (Configure Terminal Mode).
Then logon to Interface mode.
fe1 means port 1.

The **switch_a(config-if)#** prompt will show on the screen.

```
switch_a(config)#interface fe1
switch_a(config-if)#
```

2. Usage:

Use this command to define a mirror source port and its direction.
Use the no parameter with this command to disable port mirroring by the destination port on the specified source port.

3. Command Syntax:

```
mirror interface SOURCEPORT direction SNOOPDIRECTION
no mirror interface SOURCEPORT
```

SOURCEPORT Name of the Source interface to be used.
SNOOPDIRECTION [both|receive|transmit]
both Specifies mirroring of traffic in both directions.
receive Specifies mirroring of received traffic.
transmit Specifies mirroring of transmitted traffic.

4. Example:

The following example enables port mirroring by the destination port fe1 (port 1) on the specified source port fe2 (port 2):

```
switch_a(config)#interface fe1
switch_a(config-if)#mirror interface fe2 direction both
switch_a(config-if)#
```

Trunking

Port Trunking, LACP Trunking

Port Trunking

1. Command Mode: Interface mode
 Logon to Configure Mode (Configure Terminal Mode).
 Then logon to Interface mode.

fe1 means port 1.

The **switch_a(config-if)#** prompt will show on the screen.

```
switch_a(config)#interface fe1
switch_a(config-if)#
```

2. Usage:

Use **static-channel-group** command to create a static aggregator, or add a member port to an already-existing static aggregator.

Use the **no static-channel-group** command to detach the port from the static aggregator.

3. Command Syntax:

static-channel-group <1-3>

no static-channel-group

<1-3> Channel group number.

Maximum 4 ports in static-channel-group 1 and static-channel-group 2.

Maximum 2 ports in static-channel-group 3

4. Example:

The following example adding the interface fe1 (port 1) to **static-channel-group 1**:

```
switch_a(config)#interface fe1
switch_a(config-if)#static-channel-group 1
switch_a(config-if)#
```

LACP Trunking

Static Channel Group:

1. Command Mode: Interface mode
 Logon to Configure Mode (Configure Terminal Mode).
 Then logon to Interface mode.

fe1 means port 1.

The **switch_a(config-if)#** prompt will show on the screen.

```
switch_a(config)#interface fe1
switch_a(config-if)#
```

2. Usage:

Use **static-channel-group** command to create a static aggregator, or add a member port to an already-existing static aggregator.

Use the **no static-channel-group** command to detach the port from the static aggregator.

3. Command Syntax:

```
static-channel-group <1 | 3>
```

```
no static-channel-group
```

<1 | 3> Channel group number.

1 Channel group number 1 for FE ports.

3 Channel group number 3 for GE ports.

Maximum 4 ports in static-channel-group 1.

Maximum 4 ports in static-channel-group 3.

4. Example:

The following example adding the interface fe1 (port 1) to **static-channel-group 1**:

```
switch_a(config)#interface fe1
switch_a(config-if)#static-channel-group 1
switch_a(config-if)#
```

Channel Group:

1. Command Mode: Interface mode

Logon to Configure Mode (Configure Terminal Mode).

Then logon to Interface mode.

fe1 means port 1.

The **switch_a(config-if)#** prompt will show on the screen.

```
switch_a(config)#interface fe1
switch_a(config-if)#
```

2. Usage:

Use **channel-group** command to add a port to a channel group specified by the channel group number (<1 | 3>). This command enables link aggregation on a port, so that it may be selected for aggregation by the local system.

Use the **no channel-group** command to turn off link aggregation on a port.

3. Command Syntax:

```
channel-group <1 | 3> mode MODE
```

```
no channel-group
```

<1 | 3> Channel group number.

1 Channel group number 1 for FE ports.

3 Channel group number 3 for GE ports.

Maximum 4 ports in channel-group 1.

Maximum 4 ports in channel-group 3.

MODE

active Enable initiation of LACP negotiation on a port.
 passive Disable initiation of LACP negotiation on a port.

4. Example:

The following example enables initiation of LACP negotiation on the interface fe1 (port 1) to **channel-group 1**:

```
switch_a(config)#interface fe1
switch_a(config-if)#channel-group 1 mode active
switch_a(config-if)#
```

Clear LACP Counters:

1. Command Mode: Privileged Exec mode
 Logon to Privileged Exec Mode (Enable Mode).
 The **switch_a#** prompt will show on the screen.

```
switch_a#
```

2. Usage:

Use this command to clear all counters of all present LACP aggregators or a given LACP aggregator.

3. Command Syntax:

clear lacp (<1-65535>) counters
 <1-65535> Channel-group number.

4. Example:

The following example clears all counters of LACP channel group 1:

```
switch_a#clear lacp 1 counters
switch_a#
```

LACP Port Priority:

1. Command Mode: Interface mode
 Logon to Configure Mode (Configure Terminal Mode).
 Then logon to Interface mode.

fe1 means port 1.

The **switch_a(config-if)#** prompt will show on the screen.

```
switch_a(config)#interface fe1
switch_a(config-if)#
```

2. Usage:

Use **lacp port-priority** command to set the priority of a channel. Channels are selected for aggregation based on their priority with the higher priority (numerically lower) channels selected first.

Use the **no lacp port-priority** command to reset the priority of port to the default value (32768).

3. Command Syntax:

```
lACP port-priority <1-65535>
```

```
no lACP port-priority
```

<1-65535> Specify the LACP port priority.

4. Example:

The following example sets the LACP port priority **34** of interface fe1 (port 1):

```
switch_a(config)#interface fe1
switch_a(config-if)#lACP port-priority 34
switch_a(config-if)#
```

LACP Timeout:

1. Command Mode: Interface mode

Logon to Configure Mode (Configure Terminal Mode).

Then logon to Interface mode.

fe1 means port 1.

The **switch_a(config-if)#** prompt will show on the screen.

```
switch_a(config)#interface fe1
switch_a(config-if)#
```

2. Usage:

Use **lACP timeout** command to set the short or long timeout on a port. The default is long timeout

3. Command Syntax:

```
lACP timeout shor | long
```

timeout Number of seconds before invalidating a received LACP data unit (DU).

short LACP short timeout. Short timeout value is 3 seconds.

long LACP long timeout. Long timeout value is 90 seconds.

4. Example:

The following example sets the LACP short timeout on interface fe1 (port 1):

```
switch_a(config)#interface fe1
switch_a(config-if)#lACP timeout short
switch_a(config-if)#
```

LACP System Priority:

1. Command Mode: Configure mode

Logon to Configure Mode (Configure Terminal Mode).

The **switch_a(config)#** prompt will show on the screen.

```
switch_a(config)#
```

2. Usage:

Use **lACP system-priority** command to set the system priority of a local system. This is used in determining the system responsible for resolving conflicts in the choice of aggregation groups. Note: Lower numerical values have higher priorities.

Use **no lACP system-priority** command to reset the system priority of the local system to the default value (32768).

3. Command Syntax:

```
lACP system-priority <1-65535>
```

```
no lACP system-priority
```

<1-65535> LACP system priority. The default system priority is 32768.

4. Example:

The following example sets the LACP system priority **6700**:

```
switch_a(config)#lACP system-priority 6700  
switch_a(config)#
```

STP / Ring

Global Configuration, RSTP Port Setting, MSTP Properties, MSTP Instance Setting, MSTP Port Setting, Ring Setting, Chain Setting

Global Configuration

STP Version:

1. Command Mode: Configure mode

Logon to Configure Mode (Configure Terminal Mode).

The **switch_a(config)#** prompt will show on the screen.

```
switch_a(config)#
```

2. Usage:

Use this command to choose the Spanning Tree protocol, Rapid Spanning Tree protocol, or Multiple Spanning Tree protocol on a bridge.

3. Command Syntax:

```
bridge GROUP protocol PROTOCOL vlan-bridge
```

GROUP <1-1> Bridge group name used for bridging.

PROTOCOL

ieee IEEE 802.1Q spanning-tree protocol.

mstp IEEE 802.1s multiple spanning-tree protocol.

rstp IEEE 802.1w rapid spanning-tree protocol.

4. Example:

The following example chooses the PROTOCOL (**rstp**) on bridge GROUP (1):

```
switch_a(config)#bridge 1 protocol rstp vlan-bridge  
switch_a(config)#
```

Multiple Spanning Tree Protocol:

1. Command Mode: Configure mode

Logon to Configure Mode (Configure Terminal Mode).

The **switch_a(config)#** prompt will show on the screen.

```
switch_a(config)#
```

2. Usage:

Use this command to enable the Multiple Spanning Tree protocol on a bridge. Use the no form of the command to disable the Multiple Spanning Tree protocol on a bridge.

3. Command Syntax:

```
bridge GROUP multiple-spanning-tree enable
```

no bridge GROUP multiple-spanning-tree enable BRIDGE-FORWARD
 GROUP <1-1> Bridge group name used for bridging.
 BRIDGE-FORWARD Puts all ports of the specified bridge into the forwarding state.

4. Example:

The following example enables or disables the **multiple-spanning-tree** on bridge GROUP (1):

```
switch_a(config)#bridge 1 multiple-spanning-tree enable
switch_a(config)#no bridge 1 multiple-spanning-tree enable bridge-forward
switch_a(config)#
```

Rapid Spanning Tree Protocol:

1. Command Mode: Configure mode

Logon to Configure Mode (Configure Terminal Mode).

The **switch_a(config)#** prompt will show on the screen.

```
switch_a(config)#
```

2. Usage:

Use this command to enable the Rapid Spanning Tree protocol on a bridge.
 Use the no form of the command to disable the Rapid Spanning Tree protocol on a bridge.

3. Command Syntax:

bridge GROUP rapid-spanning-tree enable
 no bridge GROUP rapid-spanning-tree enable BRIDGE-FORWARD
 GROUP <1-1> Bridge group name used for bridging.
 BRIDGE-FORWARD Puts all ports of the specified bridge into the forwarding state.

4. Example:

The following example enables or disables the **rapid-spanning-tree** on bridge GROUP (1):

```
switch_a(config)#bridge 1 rapid-spanning-tree enable
switch_a(config)#no bridge 1 rapid-spanning-tree enable bridge-forward
switch_a(config)#
```

Spanning Tree Protocol:

1. Command Mode: Configure mode

Logon to Configure Mode (Configure Terminal Mode).

The **switch_a(config)#** prompt will show on the screen.

```
switch_a(config)#
```

2. Usage:

Use this command to enable the Spanning Tree protocol on a bridge.
Use the no form of the command to disable the Spanning Tree protocol on a bridge.

3. Command Syntax:

```
bridge GROUP spanning-tree enable
no bridge GROUP spanning-tree enable BRIDGE-FORWARD
GROUP <1-1> Bridge group name used for bridging.
BRIDGE-FORWARD Puts all ports of the specified bridge into the
forwarding state.
```

4. Example:

The following example enables or disables the **spanning-tree** on bridge GROUP (1):

```
switch_a(config)#bridge 1 spanning-tree enable
switch_a(config)#no bridge 1 spanning-tree enable bridge-forward
switch_a(config)#
```

Bridge Priority (0..61440):

1. Command Mode: Configure mode

Logon to Configure Mode (Configure Terminal Mode).

The **switch_a(config)#** prompt will show on the screen.

```
switch_a(config)#
```

2. Usage:

Use this command to set bridge priority for the common instance. Using a lower priority indicates a greater likelihood of the bridge becoming root.

3. Command Syntax:

```
bridge GROUP priority PRIORITY
no bridge GROUP priority
GROUP <1-1> The ID of the bridge group for which the priority is set.
PRIORITY <0-61440> The bridge priority.
```

4. Example:

The following example sets the **priority** PRIORITY (**4096**) of bridge GROUP (1):

```
switch_a(config)#bridge 1 priority 4096
switch_a(config)#
```

Hello Time (sec) (1..9):

1. Command Mode: Configure mode

Logon to Configure Mode (Configure Terminal Mode).

The **switch_a(config)#** prompt will show on the screen.

```
switch_a(config)#
```

2. Usage:

Use this command to set the hello-time, the time in seconds after which (if this bridge is the root bridge) all the bridges in a bridged LAN exchange Bridge Protocol Data Units (BPDUs).

3. Command Syntax:

```
bridge GROUP hello-time HELLOTIME
```

```
no bridge GROUP hello-time
```

GROUP <1-1> The ID of the bridge group to which this hello time is assigned.

HELLOTIME <1-9> The hello BPDU interval in seconds.

4. Example:

The following example sets the **hello-time HELLOTIME (9)** of bridge GROUP (1):

```
switch_a(config)#bridge 1 hello-time 9
switch_a(config)#
```

Max Age (sec) (6..28):

1. Command Mode: Configure mode

Logon to Configure Mode (Configure Terminal Mode).

The **switch_a(config)#** prompt will show on the screen.

```
switch_a(config)#
```

2. Usage:

Use this command to set the max-age for a bridge.

Use the no parameter with this command to restore the default value of max-age.

3. Command Syntax:

```
bridge GROUP max-age MAXAGE
```

```
no bridge GROUP max-age
```

GROUP <1-1> The ID of the bridge group to which this maximum age time is assigned.

MAXAGE <6-28> The maximum time, in seconds, to listen for the root bridge.

4. Example:

The following example sets the **max-age MAXAGE (28)** of bridge GROUP (1):

```
switch_a(config)#bridge 1 max-age 28
switch_a(config)#
```

Forward Delay (sec) (4..30):

1. Command Mode: Configure mode

Logon to Configure Mode (Configure Terminal Mode).

The **switch_a(config)#** prompt will show on the screen.

```
switch_a(config)#
```

2. Usage:

Use this command to set the time (in seconds) after which (if this bridge is the root bridge) each port changes states to learning and forwarding.

Use the no parameter with this command to restore the default value.

3. Command Syntax:

bridge GROUP forward-time FORWARD_DELAY

no bridge GROUP forward-time

GROUP <1-1> The ID of the bridge group to which this delay time is assigned.

FORWARD_DELAY <4-30> the forwarding time delay in seconds.

4. Example:

The following example sets the **forward-time FORWARD_DELAY (30)** of bridge GROUP **(1)**:

```
switch_a(config)#bridge 1 forward-time 30
switch_a(config)#
```

RSTP Port Setting

Priority(Granularity 16):

1. Command Mode: Interface mode

Logon to Configure Mode (Configure Terminal Mode).

Then logon to Interface mode.

fe1 means port 1.

The **switch_a(config-if)#** prompt will show on the screen.

```
switch_a(config)#interface fe1
switch_a(config-if)#
```

2. Usage:

Use this command to set the port priority for a bridge. The lower priority indicates a greater likelihood of the bridge becoming root.

3. Command Syntax:

bridge GROUP priority PRIORITY

GROUP <1-1> the ID of the bridge group.

PRIORITY <0-240> The priority to be assigned to the group.

4. Example:

The following example sets the priority PRIORITY **(100)** of the interface fe1

(port 1) of bridge GROUP (1):

```
switch_a(config)#interface fe1
switch_a(config-if)#bridge 1 priority 100
switch_a(config-if)#
```

Admin. Path Cost:

1. Command Mode: Interface mode
Logon to Configure Mode (Configure Terminal Mode).
Then logon to Interface mode.

fe1 means port 1.

The **switch_a(config-if)#** prompt will show on the screen.

```
switch_a(config)#interface fe1
switch_a(config-if)#
```

2. Usage:

Use this command to set the cost of a path associated with a bridge-group.
Use the no parameter with this command to restore the default cost of a path associated with a bridge-group.

3. Command Syntax:

bridge GROUP path-cost PATHCOST

no bridge GROUP path-cost

GROUP <1-1> the ID of the bridge group.

PATHCOST <1-200000000> The cost to be assigned to the group.

4. Example:

The following example sets the cost (**123**) of the interface fe1 (port 1) of bridge GROUP (1):

```
switch_a(config)#interface fe1
switch_a(config-if)#bridge 1 path-cost 123
switch_a(config-if)#
```

Point to Point Link:

1. Command Mode: Interface mode
Logon to Configure Mode (Configure Terminal Mode).
Then logon to Interface mode.

fe1 means port 1.

The **switch_a(config-if)#** prompt will show on the screen.

```
switch_a(config)#interface fe1
switch_a(config-if)#
```

2. Usage:

Use **spanning-tree link-type** command to set the link type of a port to enable or disable rapid transition.

Use the **no spanning-tree link-type** command to set a port to its default state and to disable rapid transition.

3. Command Syntax:

(no) spanning-tree link-type LINKTYPE

LINKTYPE The link type to be assigned to the port.

point-to-point Enable rapid transition.

shared Disable rapid transition.

4. Example:

The following example sets the link-type LINKTYPE (**point-to-point**) of the interface fe1 (port 1):

```
switch_a(config)#interface fe1
switch_a(config-if)#spanning-tree link-type point-to-point
switch_a(config-if)#
```

Autoedge:

1. Command Mode: Interface mode

Logon to Configure Mode (Configure Terminal Mode).

Then logon to Interface mode.

fe1 means port 1.

The **switch_a(config-if)#** prompt will show on the screen.

```
switch_a(config)#interface fe1
switch_a(config-if)#
```

2. Usage:

Use **spanning-tree autoedge** command to assist in automatic identification of the edge port.

Use the **no spanning-tree autoedge** command to disable this feature.

3. Command Syntax:

(no) spanning-tree autoedge

4. Example:

The following example enables the **spanning-tree autoedge** of the interface fe1 (port 1):

```
switch_a(config)#interface fe1
switch_a(config-if)#spanning-tree autoedge
switch_a(config-if)#
```

Edgeport:

1. Command Mode: Interface mode

Logon to Configure Mode (Configure Terminal Mode).

Then logon to Interface mode.

fe1 means port 1.

The **switch_a(config-if)#** prompt will show on the screen.

```
switch_a(config)#interface fe1
switch_a(config-if)#
```

2. Usage:

Use **spanning-tree edgeport** command to set a port as an edge-port and to enable rapid transitions.

Use the **no spanning-tree edgeport** command to set a port to its default state (not an edge-port) and to disable rapid transitions.

3. Command Syntax:

(no) spanning-tree edgeport

4. Example:

The following example enables the **spanning-tree edgeport** of the interface fe1 (port 1):

```
switch_a(config)#interface fe1
switch_a(config-if)#spanning-tree edgeport
switch_a(config-if)#
```

MSTP Properties

Region Name:

1. Command Mode: MST Configuration mode

Logon to Configure Mode (Configure Terminal Mode).

Then logon to MST Configuration mode.

The **switch_a(config-mst)#** prompt will show on the screen.

```
switch_a(config)#spanning-tree mst configuration
switch_a(config-mst)#
```

2. Usage:

Use this command to create an MST region and specify a name to it. MST bridges of a region form different spanning trees for different VLANs. By default, each MST bridge starts with the region name as its bridge address. This means each MST bridge is a region by itself, unless specifically added to one.

3. Command Syntax:

bridge GROUP region REGION_NAME

no bridge GROUP region

GROUP <1-1> Specify the bridge-group ID.

REGION_NAME Specify the name of the region.

4. Example:

The following example creates an MST region and specifies a name (**regionname**) to it in bridge GROUP (1):

```
switch_a(config)#spanning-tree mst configuration
switch_a(config-mst)#bridge 1 region regionname
switch_a(config-mst)#
```

Revision Level:

1. Command Mode: MST Configuration mode
Logon to Configure Mode (Configure Terminal Mode).
Then logon to MST Configuration mode.

The **switch_a(config-mst)#** prompt will show on the screen.

```
switch_a(config)#spanning-tree mst configuration
switch_a(config-mst)#
```

2. Usage:

Use this command to specify the number for configuration information. The default value of revision number is 0.

3. Command Syntax:

```
bridge GROUP revision REVISION_NUM
GROUP <1-1> Specify the bridge-group ID.
REVISION_NUM <0-255> Revision number.
```

4. Example:

The following example specifies a revision number (**25**) of MST configuration in bridge GROUP (**1**):

```
switch_a(config)#spanning-tree mst configuration
switch_a(config-mst)#bridge 1 revision 25
switch_a(config-mst)#
```

Max Hops:

1. Command Mode: Configure mode
Logon to Configure Mode (Configure Terminal Mode).
The **switch_a(config)#** prompt will show on the screen.

```
switch_a(config)#
```

2. Usage:

Use this command to specify the maximum allowed hops for BPDU in an MST region. This parameter is used by all the instances of the MST. Specifying the max hops for a BPDU prevents the messages from looping indefinitely in the network. When a bridge receives a MST BPDU that has exceeded the allowed max-hops, it discards the BPDU.

3. Command Syntax:

```
bridge GROUP max-hops HOP_COUNT
no bridge GROUP max-hops
```

GROUP <1-1> Specify the bridge-group ID.
HOP_COUNT Maximum hops the BPDU will be valid for.

4. Example:

The following example specifies the maximum allowed hops (**25**) for BPDU in bridge GROUP (**1**):

```
switch_a(config)#bridge 1 max-hops 25
switch_a(config)#
```

MSTP Instance Setting

Bridge Instance VLAN:

1. Command Mode: MST Configuration mode
Logon to Configure Mode (Configure Terminal Mode).
Then logon to MST Configuration mode.

The **switch_a(config-mst)#** prompt will show on the screen.

```
switch_a(config)#spanning-tree mst configuration
switch_a(config-mst)#
```

2. Usage:

Use this command to simultaneously add multiple VLANs for the corresponding instance of a bridge. This command can be used only after the VLANs are defined. Use the no parameter with this command to simultaneously remove multiple VLANs for the corresponding instance of a bridge.

3. Command Syntax:

```
bridge GROUP instance INSTANCE_ID vlan VLAN_ID
no bridge GROUP instance INSTANCE_ID vlan VLAN_ID
```

GROUP <1-1> Specify the bridge-group ID.

INSTANCE_ID <1-15> Specify the instance ID.

VLAN_ID <1-4094> Specify multiple VLAN IDs corresponding to the bridge instance

4. Example:

The following example associates multiple VLANs (**10**) and (**20**) to instance (**1**) of bridge GROUP (**1**):

```
switch_a(config)#bridge 1 protocol mstp
switch_a(config)#spanning-tree mst configuration
switch_a(config-mst)#bridge 1 instance 1 vlan 10, 20
switch_a(config-mst)#
```

Bridge Instance Priority:

1. Command Mode: Configure mode
Logon to Configure Mode (Configure Terminal Mode).

The **switch_a(config)#** prompt will show on the screen.

```
switch_a(config)#
```

2. Usage:

Use this command to set the bridge priority for an MST instance to the value specified. Use the no parameter with this command to restore the default value of the bridge priority. The lower the priority of the bridge, the better the chances are the bridge becoming a root bridge or a designated bridge for the LAN. The priority values can be set only in increments of 4096.

3. Command Syntax:

```
bridge GROUP instance INSTANCE_ID priority BRIDGE_PRIORITY
no bridge GROUP instance INSTANCE_ID priority
GROUP <1-1> Specify the bridge-group ID.
INSTANCE_ID Specify the instance ID.
BRIDGE_PRIORITY <0-61440> Specify the bridge priority.
```

4. Example:

The following example sets the bridge priority (**0**) for an MST instance (**3**) in bridge GROUP (**1**):

```
switch_a(config)#bridge 1 instance 3 priority 0
switch_a(config)#
```

MSTP Port Setting

Bridge-Group Instance:

1. Command Mode: Interface mode
 Logon to Configure Mode (Configure Terminal Mode).
 Then logon to Interface mode.
 fe1 means port 1.

The **switch_a(config-if)#** prompt will show on the screen.

```
switch_a(config)#interface fe1
switch_a(config-if)#
```

2. Usage:

Use this command to assign a Multiple Spanning Tree instance to a port. Use the no parameter with this command to remove the instance.

3. Command Syntax:

```
bridge GROUP instance INSTANCE_ID
no bridge GROUP instance INSTANCE_ID
GROUP <1-1> Specify the bridge-group ID.
INSTANCE_ID Specify the instance ID.
```

4. Example:

The following example assigns a Multiple Spanning Tree instance (**3**) to a port (**fe1**) in bridge GROUP (**1**):

```
switch_a(config)#interface fe1
switch_a(config-if)#bridge-group 1 instance 3
switch_a(config-if)#
```

Bridge-Group Instance Priority:

1. Command Mode: Interface mode
Logon to Configure Mode (Configure Terminal Mode).
Then logon to Interface mode.
fe1 means port 1.

The **switch_a(config-if)#** prompt will show on the screen.

```
switch_a(config)#interface fe1
switch_a(config-if)#
```

2. Usage:

Use this command to set the port priority for a bridge group. The Multiple Spanning Tree Protocol uses port priority as a tiebreaker to determine which port should forward frames for a particular instance on a LAN, or which port should be the root port for an instance. A lower value implies a better priority. In the case of the same priority, the interface index will serve as the tiebreaker, with the lower-numbered interface being preferred over others. The permitted range is 0-240. The priority values can only be set in increments of 16.

3. Command Syntax:

```
bridge GROUP instance INSTANCE_ID priority PRIORITY
GROUP <1-1> Specify the bridge-group ID.
INSTANCE_ID <1-15> Specify the instance ID.
PRIORITY <0-240> Specify the port priority in a range of <0-240>.
```

4. Example:

The following example sets the port priority (**121**) for Multiple Spanning Tree instance (**3**) to a port (**fe1**) in bridge GROUP (**1**):

```
switch_a(config)#interface fe1
switch_a(config-if)#bridge-group 1 instance 3 priority 121
switch_a(config-if)#
```

Bridge-Group Instance Path-Cost:

1. Command Mode: Interface mode
Logon to Configure Mode (Configure Terminal Mode).
Then logon to Interface mode.
fe1 means port 1.

The **switch_a(config-if)#** prompt will show on the screen.

```
switch_a(config)#interface fe1
switch_a(config-if)#
```

2. Usage:

Use this command to set the cost of a path associated with an interface. Use the no parameter with this command to restore the default cost value of the path. A lower path-cost indicates a greater likelihood of the specific interface becoming a root.

3. Command Syntax:

```
bridge GROUP instance INSTANCE_ID path-cost PATH_COST
```

GROUP <1-1> Specify the bridge-group ID.

INSTANCE_ID <1-15> Specify the instance ID.

PATH_COST <1-200000000> Specify the cost of path in the range of <1-200000000>.

4. Example:

The following example sets the path cost (**1000**) for Multiple Spanning Tree instance (**3**) to a port (**fe1**) in bridge GROUP (**1**):

```
switch_a(config)#interface fe1
switch_a(config-if)#bridge-group 1 instance 3 path-cost 1000
switch_a(config-if)#
```

Ring Setting

Ring state:

1. Command Mode: Configure mode

Logon to Configure Mode (Configure Terminal Mode).

The **switch_a(config)#** prompt will show on the screen.

```
switch_a(config)#
```

2. Usage:

Use this command to enable Ring state. Use the no parameter with this command to disable Ring state.

3. Command Syntax:

```
bridge GROUP protocol ring
```

```
no bridge GROUP ring enable BRIDGE-FORWARD
```

GROUP <1-1> Specify the bridge-group ID.

BRIDGE-FORWARD Puts all ports of the specified bridge into the forwarding state.

4. Example:

The following example enables Ring state in bridge GROUP (**1**):

```
switch_a(config)#bridge 1 protocol ring
switch_a(config)#
```

Set ring port:

1. Command Mode: Configure mode

Logon to Configure Mode (Configure Terminal Mode).

The **switch_a(config)#** prompt will show on the screen.

```
switch_a(config)#
```

2. Usage:

Use this command to set Ring port 1 and Ring port 2.

3. Command Syntax:

```
ring set-port RING_PORT_1 RING_PORT_2
```

RING_PORT_1 Specify the Ring port 1.

RING_PORT_2 Specify the Ring port 2.

4. Example:

The following example sets the fe1 and fe2 as Ring port 1 and Ring port 2:

```
switch_a(config)#ring set-port fe1 fe2
switch_a(config)#
```

Ring-coupling state:

1. Command Mode: Configure mode

Logon to Configure Mode (Configure Terminal Mode).

The **switch_a(config)#** prompt will show on the screen.

```
switch_a(config)#
```

2. Usage:

Use this command to enable Ring-coupling state. Use the no parameter with this command to disable Ring-coupling state.

3. Command Syntax:

```
(no) ring-coupling enable
```

4. Example:

The following example enables Ring-coupling state:

```
switch_a(config)#ring-coupling enable
switch_a(config)#
```

Set ring-coupling port:

1. Command Mode: Configure mode

Logon to Configure Mode (Configure Terminal Mode).

The **switch_a(config)#** prompt will show on the screen.

```
switch_a(config)#
```

2. Usage:

Use this command to set Ring-coupling port 1 and Ring-coupling port 2.

3. Command Syntax:

```
ring set-coupling-port COUPLING_PORT_1 COUPLING_PORT_2
COUPLING_PORT_1 Specify the Ring-coupling port 1.
COUPLING_PORT_2 Specify the Ring-coupling port 2.
```

4. Example:

The following example sets the fe3 and fe4 as Ring-coupling port 1 and Ring port-coupling 2:

```
switch_a(config)#ring set-coupling-port fe3 fe4
switch_a(config)#
```

Chain Setting

Chain Protocol:

1. Command Mode: Interface mode
 Logon to Configure Mode (Configure Terminal Mode).
 Then logon to Interface mode.
 fe1 means port 1.

The **switch_a(config-if)#** prompt will show on the screen.

```
switch_a(config)#interface fe1
switch_a(config-if)#
```

2. Usage:

Use this command to set Chain Protocol to an interface. Use the no parameter with this command to revoke Chain Protocol from an interface.

3. Command Syntax:

```
chain port enable
no chain port
```

4. Example:

The following example sets Chain Protocol to the interface fe1 (port 1):

```
switch_a(config)#interface fe1
switch_a(config-if)#chain port enable
switch_a(config-if)#
```

Chain Priority:

1. Command Mode: Configure mode
 Logon to Configure Mode (Configure Terminal Mode).

The **switch_a(config)#** prompt will show on the screen.

```
switch_a(config)#
```

2. Usage:

Use this command to set the Switch priority for running chain protocol. Switch with lower priority will run as Master (forwarding) port. Use the no form of the command to restore default value (128).

3. Command Syntax:

Bridge GROUP chain-priority <0-255>

no bridge GROUP chain-priority

Group = <1-1> Bridge Group name for bridging.

<0-255> The Switch priority for running chain protocol.

4. Example:

The following example sets the new Switch priority (**10**) to bridge GROUP (**1**):

```
switch_a(config)#bridge 1 chain-priority 10
switch_a(config)#
```

Chain Timeout:

1. Command Mode: Configure mode

Logon to Configure Mode (Configure Terminal Mode).

The **switch_a(config)#** prompt will show on the screen.

```
switch_a(config)#
```

2. Usage:

Use this command to set the Switch timeout count for running chain protocol.

Chain recovery time = (Chain Timeout Count – 1) x 200ms.

Use the no form of the command to restore default value (5).

Default Chain recovery time = (5 – 1) x 200ms = 800ms.

3. Command Syntax:

Bridge GROUP chain-timeout <3-255>

no bridge GROUP chain-timeout

Group = <1-1> Bridge Group name for bridging.

<3-255> The Switch timeout count for running chain protocol.

4. Example:

The following example sets the new Switch timeout (**10**) to bridge GROUP

(**1**):

```
switch_a(config)#bridge 1 chain-timeout 10
switch_a(config)#
```

VLAN

VLAN Mode Setting, 802.1Q VLAN Setting, 802.1Q Port Setting, Port Based VLAN

802.1Q VLAN Setting

VLAN Database:

1. Command Mode: Configure mode

Logon to Configure Mode (Configure Terminal Mode).

The **switch_a(config)#** prompt will show on the screen.

```
switch_a(config)#
```

2. Usage:

Use **vlan database** command to enter the VLAN configuration mode.

3. Command Syntax:

vlan database

4. Example:

The following example changes to VLAN configuration mode from Configure mode:

```
switch_a(config)#vlan database
switch_a(config-vlan)#
```

Add VLAN/Delete VLAN:

1. Command Mode: VLAN Configure mode

Logon to Configure Mode (Configure Terminal Mode).

Logon to VLAN Configure Mode.

The **switch_a(config-vlan)#** prompt will show on the screen.

```
switch_a(config)#vlan database
switch_a(config-vlan)#
```

2. Usage:

This command enables or disables the state of a particular VLAN on a bridge basis. Specifying the disable state causes all forwarding over the specified VLAN ID on the specified bridge to cease. Specifying the enable state allows forwarding of frames on the specified VLAN-aware bridge.

3. Command Syntax:

vlan VLANID bridge GROUP name VLAN_NAME state enable/disable
no vlan VLANID bridge GROUP

VLANID The VID of the VLAN that will be enabled or disabled on the bridge <2-4094>.

GROUP <1-1> The ID of the bridge-group on which the VLAN will be affected.

VLAN_NAME The ASCII name of the VLAN. Maximum length: 16 characters.

enable Sets VLAN into an enable state.

disable Sets VLAN into a disable state.

4. Example:

The following example enables the vlan VLANID (2) and name VLAN_NAME (**vlan2**) of bridge GROUP (1):

```
switch_a(config-vlan)#vlan 2 bridge 1 name vlan2 state enable
switch_a(config-vlan)#
```

802.1Q Port Setting

Switchport mode access:

1. Command Mode: Interface mode

Logon to Configure Mode (Configure Terminal Mode).

Then logon to Interface mode.

fe1 means port 1.

The **switch_a(config-if)#** prompt will show on the screen.

```
switch_a(config)#interface fe1
switch_a(config-if)#
```

2. Usage:

Use **switchport mode access** command to set the switching characteristics of the Layer-2 interface to access mode, and classify untagged frames only.

Use the **no switchport access** command to reset the mode of the Layer-2 interface to access (default).

3. Command Syntax:

```
switchport mode access
```

```
no switchport access
```

4. Example:

The following example sets the **switchport mode access** of the interface fe1 (port 1):

```
switch_a(config)#interface fe1
switch_a(config-if)#switchport mode access
switch_a(config-if)#
```

Switchport mode hybrid:

1. Command Mode: Interface mode

Logon to Configure Mode (Configure Terminal Mode).

Then logon to Interface mode.

fe1 means port 1.

The **switch_a(config-if)#** prompt will show on the screen.

```
switch_a(config)#interface fe1
switch_a(config-if)#
```

2. Usage:

Use **switchport mode hybrid** command to set the switching characteristics of the Layer-2 interface as hybrid, and classify both tagged and untagged frames.

Use the **no switchport hybrid** command to reset the mode of the Layer-2 interface to access (default).

3. Command Syntax:

switchport mode hybrid

switchport mode hybrid acceptable-frame-type all/vlan-tagged

no switchport hybrid

all Set all frames can be received.

vlan-tagged Set vlan-tagged frames can only be received.

4. Example:

The following example sets the **switchport mode hybrid** of the interface fe1 (port 1) and all frames to be received on interface fe1 (port 1):

```
switch_a(config)#interface fe1
switch_a(config-if)#switchport mode hybrid acceptable-frame-type all
switch_a(config-if)#
```

Switchport mode trunk:

1. Command Mode: Interface mode

Logon to Configure Mode (Configure Terminal Mode).

Then logon to Interface mode.

fe1 means port 1.

The **switch_a(config-if)#** prompt will show on the screen.

```
switch_a(config)#interface fe1
switch_a(config-if)#
```

2. Usage:

Use **switchport mode trunk** command to set the switching characteristics of the Layer-2 interface as trunk, and specify only tagged frames.

Use the **no switchport trunk** command to reset the mode of the Layer-2 interface to access (default).

3. Command Syntax:

switchport mode trunk

no switchport trunk

4. Example:

The following example sets the **switchport mode trunk** of the interface fe1 (port 1):

```
switch_a(config)#interface fe1
switch_a(config-if)#switchport mode trunk
switch_a(config-if)#
```

Switchport hybrid allowed vlan:

1. Command Mode: Interface mode
Logon to Configure Mode (Configure Terminal Mode).
Then logon to Interface mode.
fe1 means port 1.

The **switch_a(config-if)#** prompt will show on the screen.

```
switch_a(config)#interface fe1
switch_a(config-if)#
```

2. Usage:

Use this command to set the switching characteristics of the Layer-2 interface to hybrid. Both tagged and untagged frames will be classified over hybrid interfaces.

Use the no parameter to turn off allowed hybrid switching.

3. Command Syntax:

```
switchport hybrid allowed vlan all
switchport hybrid allowed vlan none
switchport hybrid allowed vlan add VLANID egress-tagged enable/disable
switchport hybrid allowed vlan remove VLANID
no switchport hybrid vlan
```

all Allow all VLANs to transmit and receive through the Layer-2 interface.

none Allow no VLANs to transmit and receive through the Layer-2 interface.

add Add a VLAN to the member set.

remove Remove a VLAN from the member set.

VLANID <2-4094> The ID of the VLAN or VLANs that will be added to, or removed from, the Layer-2 interface.

For a VLAN range, specify two VLAN numbers: lowest, then highest number in the range, separated by a hyphen.

For a VLAN list, specify the VLAN numbers separated by commas.

egress-tagged

enable Enable the egress tagging for the outgoing frames.

disable Disable the egress tagging for the outgoing frames.

4. Example:

The following example specifies to **add** the interface fe1 (port 1) to VLANID (2) and **enable** the **egress-tagged** for the outgoing frames on interface fe1 (port 1):

```
switch_a(config)#interface fe1
switch_a(config-if)#switchport hybrid allowed vlan add 2 egress-tagged enable
```



```
switch_a(config-if)#
```

Switchport trunk allowed vlan:

1. Command Mode: Interface mode
Logon to Configure Mode (Configure Terminal Mode).
Then logon to Interface mode.
fe1 means port 1.

The **switch_a(config-if)#** prompt will show on the screen.

```
switch_a(config)#interface fe1  
switch_a(config-if)#
```

2. Usage:

Use this command to set the switching characteristics of the Layer-2 interface to trunk. The all parameter indicates that any VLAN ID is part of its port's member set. The none parameter indicates that no VLAN ID is configured on this port. The add and remove parameters will add and remove VLAN IDs to/from the port's member set.

Use the no parameter to remove all VLAN IDs configured on this port.

3. Command Syntax:

```
switchport trunk allowed vlan all  
switchport trunk allowed vlan none  
switchport trunk allowed vlan add VLANID  
switchport trunk allowed vlan remove VLANID  
switchport trunk allowed vlan except VLANID  
no switchport trunk vlan
```

all Allow all VLANs to transmit and receive through the Layer-2 interface.

none Allow no VLANs to transmit and receive through the Layer-2 interface.

add Add a VLAN to transmit and receive through the Layer-2 interface.

remove Remove a VLAN from transmit and receive through the Layer-2 interface.

except All VLANs, except the VLAN for which the ID is specified, are part of its ports member set.

VLANID <2-4094> The ID of the VLAN or VLANs that will be added to, or removed from, the Layer-2 interface. A single VLAN, VLAN range, or VLAN list can be set.

For a VLAN range, specify two VLAN numbers: lowest, then highest number in the range, separated by a hyphen.

For a VLAN list, specify the VLAN numbers separated by commas.

4. Example:

The following example specifies to **add** the interface fe1 (port 1) to VLANID (2):

```
switch_a(config)#interface fe1  
switch_a(config-if)#switchport trunk allowed vlan add 2  
switch_a(config-if)#
```

Port Based VLAN

Switchport portbase add/remove vlan:

1. Command Mode: Interface mode
Logon to Configure Mode (Configure Terminal Mode).
Then logon to Interface mode.
fe1 means port 1.

The **switch_a(config-if)#** prompt will show on the screen.

```
switch_a(config)#interface fe1  
switch_a(config-if)#
```

2. Usage:

Use this command to set or remove the default VLAN for the interface.

3. Command Syntax:

switchport portbase add | remove vlan VLANID

VLANID The ID of the VLAN will be added to or removed from the Layer-2 interface.

4. Example:

The following example specifies to **add** the interface fe1 (port 1) to VLANID (2):

```
switch_a(config)#interface fe1  
switch_a(config-if)#switchport portbase add vlan 2  
switch_a(config-if)#
```

QoS

Global Configuration, 802.1p Priority, DSCP

Global Configuration

QoS:

1. Command Mode: Configure mode

Logon to Configure Mode (Configure Terminal Mode).

The **switch_a(config)#** prompt will show on the screen.

```
switch_a(config)#
```

2. Usage:

Use **mls qos enable** command to globally enable QoS.

Use the **no mls qos** command to globally disable QoS.

3. Command Syntax:

mls qos enable

(no) mls qos

4. Example:

The following example globally enables QoS on the switch:

```
switch_a(config)#mls qos enable
switch_a(config)#
```

Trust:

1. Command Mode: Configure mode

Logon to Configure Mode (Configure Terminal Mode).

The **switch_a(config)#** prompt will show on the screen.

```
switch_a(config)#
```

2. Usage:

Use **mls qos trust** command to turn on QoS trust CoS or DSCP.

Use the **no mls qos trust** command to turn off QoS trust CoS or DSCP.

3. Command Syntax:

(no) mls qos trust cos/dscp

cos Class of Service.

dscp Differentiated Service Code Point.

4. Example:

The following example turns on QoS trust CoS on the switch:

```
switch_a(config)#mls qos trust cos
```

```
switch_a(config)#
```

Strict Priority:

1. Command Mode: Configure mode

Logon to Configure Mode (Configure Terminal Mode).

The **switch_a(config)#** prompt will show on the screen.

```
switch_a(config)#
```

2. Usage:

Use **priority-queue out** command to enable the egress expedite queue.

Use the **no priority-queue out** command to disable the egress expedite queue.

3. Command Syntax:

(no) priority-queue out

4. Example:

The following example enables the egress expedite queue on the switch:

```
switch_a(config)#priority-queue out
switch_a(config)#
```

Weighted Round Robin:

1. Command Mode: Configure mode

Logon to Configure Mode (Configure Terminal Mode).

The **switch_a(config)#** prompt will show on the screen.

```
switch_a(config)#
```

2. Usage:

Use **wrr-queue bandwidth** command to specify the bandwidth ratios of the transmit queues.

3. Command Syntax:

wrr-queue bandwidth WRR_WTS

WRR_WTS Weighted Round Robin (WRR) weights for the 4 queues (4 values separated by spaces). Range is 1-55.

4. Example:

The following example specifies the bandwidth ratios of the transmit queues on the switch:

```
switch_a(config)#wrr-queue bandwidth 1 2 4 8
switch_a(config)#
```

802.1p Priority

1. Command Mode: Configure mode

Logon to Configure Mode (Configure Terminal Mode).

The **switch_a(config)#** prompt will show on the screen.

```
switch_a(config)#
```

2. Usage:

Use **wrr-queue cos-map** command to specify CoS values for a queue.

3. Command Syntax:

```
wrr-queue cos-map QUEUE_ID COS_VALUE
```

QUEUE_ID Queue ID. Range is 0-3.

COS_VALUE CoS values. Up to 8 values (separated by spaces). Range is 0-7.

4. Example:

The following example shows mapping CoS values 0 and 1 to queue 1 on the switch:

```
switch_a(config)#wrr-queue cos-map 1 0 1  
switch_a(config)#
```

DSCP

1. Command Mode: Configure mode

Logon to Configure Mode (Configure Terminal Mode).

The **switch_a(config)#** prompt will show on the screen.

```
switch_a(config)#
```

2. Usage:

Use **mls qos map dscp-queue** command to map the DSCP values to a queue.

3. Command Syntax:

```
mls qos map dscp-queue DSCP_VALUE to QUEUE_ID
```

DSCP_VALUE DSCP values. Up to 8 values (separated by spaces). Range is 0-63.

QUEUE_ID Queue ID. Range is 0-3.

4. Example:

The following example shows mapping DSCP values 0 to 3 to queue 1 on the switch:

```
switch_a(config)#mls qos map dscp-queue 0 1 2 3 to 1  
switch_a(config)#
```

SNMP

SNMP General Setting, SNMP v1/v2c, SNMP v3

SNMP General Setting

SNMP Status:

1. Command Mode: Configure mode

Logon to Configure Mode (Configure Terminal Mode).

The **switch_a(config)#** prompt will show on the screen.

```
switch_a(config)#
```

2. Usage:

Use **snmp-server enable** command to enable and **no snmp-server enable** command to disable SNMP to the switch.

3. Command Syntax:

(no) snmp-server enable

4. Example:

The following example enables SNMP to the switch:

```
switch_a(config)#snmp-server enable
switch_a(config)#
```

Description:

1. Command Mode: Configure mode

Logon to Configure Mode (Configure Terminal Mode).

The **switch_a(config)#** prompt will show on the screen.

```
switch_a(config)#
```

2. Usage:

Use **snmp-server description** command to specify and **no snmp-server description** command to remove description for SNMP.

3. Command Syntax:

snmp-server description DESCRIPTION

no snmp-server description

DESCRIPTION The description for SNMP.

4. Example:

The following example specifies description (**description**) for SNMP:

```
switch_a(config)#snmp-server description description
switch_a(config)#
```

Location:

1. Command Mode: Configure mode

Logon to Configure Mode (Configure Terminal Mode).

The **switch_a(config)#** prompt will show on the screen.

```
switch_a(config)#
```

2. Usage:

Use **snmp-server location** command to specify and **no snmp-server location** command to remove location for SNMP.

3. Command Syntax:

snmp-server location LOCATION

no snmp-server location

LOCATION The location for SNMP.

4. Example:

The following example specifies location (**location**) for SNMP:

```
switch_a(config)#snmp-server location location
switch_a(config)#
```

Contact:

1. Command Mode: Configure mode

Logon to Configure Mode (Configure Terminal Mode).

The **switch_a(config)#** prompt will show on the screen.

```
switch_a(config)#
```

2. Usage:

Use **snmp-server contact** command to specify and **no snmp-server contact** command to remove contact for SNMP.

3. Command Syntax:

snmp-server contact CONTACT

no snmp-server contact

CONTACT The contact for SNMP.

4. Example:

The following example specifies contact (**contact**) for SNMP:

```
switch_a(config)#snmp-server contact contact
switch_a(config)#
```

Trap Community Name:

1. Command Mode: Configure mode
Login to Configure Mode (Configure Terminal Mode).
The **switch_a(config)#** prompt will show on the screen.

```
switch_a(config)#
```

2. Usage:
Use this command to specify trap community name for SNMP.
Use the no parameter with this command to remove trap community name for SNMP.

3. Command Syntax:
snmp-server trap-community <1-5> NAME
no snmp-server trap-community <1-5>
<1-5> The trap community 1-5.
NAME The trap community name for SNMP.

4. Example:
The following example specifies trap community name 1 (**name**) for SNMP:

```
switch_a(config)#snmp-server trap-community 1 name  
switch_a(config)#
```

Trap Host IP Address:

1. Command Mode: Configure mode
Login to Configure Mode (Configure Terminal Mode).
The **switch_a(config)#** prompt will show on the screen.

```
switch_a(config)#
```

2. Usage:
Use this command to specify trap host IP address for SNMP.
Use the no parameter with this command to remove trap host IP address for SNMP.

3. Command Syntax:
snmp-server trap-ipaddress <1-5> IP-ADDRESS
no snmp-server trap-ipaddress <1-5>
<1-5> The trap host IP address 1-5.
IP-ADDRESS The trap host IP address for SNMP. A.B.C.D specifies the IP address.

4. Example:
The following example specifies trap host 1 IP address (**192.168.1.20**) for SNMP:

```
switch_a(config)#snmp-server trap-ipaddress 1 192.168.1.20  
switch_a(config)#
```

Link Down Trap:

1. Command Mode: Configure mode

Logon to Configure Mode (Configure Terminal Mode).

The **switch_a(config)#** prompt will show on the screen.

```
switch_a(config)#
```

2. Usage:

Use **snmp-server trap-type enable linkDown** command to enable link down trap for SNMP.

Use the **no snmp-server trap-type enable linkDown** command to disable link down trap for SNMP.

3. Command Syntax:

(no) snmp-server trap-type enable linkDown

4. Example:

The following example enables link down trap for SNMP:

```
switch_a(config)#snmp-server trap-type enable linkDown
switch_a(config)#
```

Link Up Trap:

1. Command Mode: Configure mode

Logon to Configure Mode (Configure Terminal Mode).

The **switch_a(config)#** prompt will show on the screen.

```
switch_a(config)#
```

2. Usage:

Use **snmp-server trap-type enable linkUp** command to enable link up trap for SNMP.

Use the **no snmp-server trap-type enable linkUp** command to disable link up trap for SNMP.

3. Command Syntax:

(no) snmp-server trap-type enable linkUp

4. Example:

The following example enables link up trap for SNMP:

```
switch_a(config)#snmp-server trap-type enable linkUp
switch_a(config)#
```

SNMP v1/v2c

Get Community Name:

1. Command Mode: Configure mode

Logon to Configure Mode (Configure Terminal Mode).

The **switch_a(config)#** prompt will show on the screen.

```
switch_a(config)#
```

2. Usage:

Use **snmp-server community get** command to specify and **no snmp-server community get** command to remove get community name for SNMP.

3. Command Syntax:

snmp-server community get NAME

no snmp-server community get

NAME The get community name for SNMP.

4. Example:

The following example specifies get community name (**name**) for SNMP:

```
switch_a(config)#snmp-server community get name
switch_a(config)#
```

Set Community Name:

1. Command Mode: Configure mode

Logon to Configure Mode (Configure Terminal Mode).

The **switch_a(config)#** prompt will show on the screen.

```
switch_a(config)#
```

2. Usage:

Use **snmp-server community set** command to specify and **no snmp-server community set** command to remove set community name for SNMP.

3. Command Syntax:

snmp-server community set NAME

no snmp-server community set

NAME The set community name for SNMP.

4. Example:

The following example specifies set community name (**name**) for SNMP:

```
switch_a(config)#snmp-server community set name
switch_a(config)#
```

SNMP v3

SNMPv3 No-Auth:

1. Command Mode: Configure mode

Logon to Configure Mode (Configure Terminal Mode).

The **switch_a(config)#** prompt will show on the screen.

```
switch_a(config)#
```

2. Usage:

Add a user using snmp v3 with read-only or read-write access mode and without authentication. Use the no form of the command to delete this user.

3. Command Syntax:

(no) snmp-server v3-user USERNAME (ro | rw) noauth

USERNAME Specify a user name.

ro read-only access mode

rw read-write access mode

4. Example:

The following example adds a user (**myuser**) using snmp v3 with read-only access mode and without authentication:

```
switch_a(config)#snmp-server v3-user myuser ro noauth
switch_a(config)#
```

SNMPv3 Auth-MD5, SNMPv3 Auth-SHA:

1. Command Mode: Configure mode

Logon to Configure Mode (Configure Terminal Mode).

The **switch_a(config)#** prompt will show on the screen.

```
switch_a(config)#
```

2. Usage:

Add a user using snmp v3 with read-only or read-write access mode and with MD5 or SHA authentication. Use the no form of the command to delete this user.

3. Command Syntax:

(no) snmp-server v3-user USERNAME (ro | rw) auth (md5 | sha)

AUTH_PASSWORD

USERNAME Specify a user name.

ro read-only access mode

rw read-write access mode

md5 authentication method

sha authentication method

AUTH_PASSWORD authentication password

4. Example:

The following example adds a user (**myuser**) using snmp v3 with read-write access mode and MD5 authentication (**mypassword**):

```
switch_a(config)#snmp-server v3-user myuser rw auth md5 mypassword
switch_a(config)#
```

SNMPv3 Priv Auth-MD5, SNMPv3 Priv Auth-SHA:

1. Command Mode: Configure mode

Logon to Configure Mode (Configure Terminal Mode).

The **switch_a(config)#** prompt will show on the screen.

```
switch_a(config)#
```

2. Usage:

Add a user using snmp v3 with read-only or read-write access mode, MD5 or SHA authentication, and privacy. Use the no form of the command to delete this user.

3. Command Syntax:

```
(no) snmp-server v3-user USERNAME (ro | rw) priv auth (md5 | sha)
AUTH_PASSWORD des PRIV_PASS_PHRASE
```

USERNAME Specify a user name.

ro read-only access mode

rw read-write access mode

md5 authentication method

sha authentication method

AUTH_PASSWORD authentication password

PRIV_PASS_PHRASE encryption pass phrase

4. Example:

The following example adds a user (**myuser**) using snmp v3 with read-write access mode, MD5 authentication (**mypassword**), and encryption pass phrase (**mypassphrase**):

```
switch_a(config)#snmp-server v3-user myuser rw priv md5 mypassword
des mypassphrase
switch_a(config)#
```

802.1x

Radius Configuration, Port Authentication

Radius Configuration

Radius Status:

1. Command Mode: Configure mode

Logon to Configure Mode (Configure Terminal Mode).

The **switch_a(config)#** prompt will show on the screen.

```
switch_a(config)#
```

2. Usage:

Use **dot1x system-auth-ctrl** command to globally enable authentication.

Use **no dot1x system-auth-ctrl** command to globally disable authentication.

3. Command Syntax:

(no) dot1x system-auth-ctrl

4. Example:

The following example globally enables authentication:

```
switch_a(config)#dot1x system-auth-ctrl  
switch_a(config)#
```

Radius Server IP:

Radius Server Port:

1. Command Mode: Configure mode

Logon to Configure Mode (Configure Terminal Mode).

The **switch_a(config)#** prompt will show on the screen.

```
switch_a(config)#
```

2. Usage:

Use this command to specify the IP address of the remote radius server host and assign authentication and accounting destination port number.

3. Command Syntax:

(no) radius-server host IP-ADDRESS auth-port PORT

IP-ADDRESS A.B.C.D specifies the IP address of the radius server host.

PORT specifies the UDP destination port for authentication requests. The host is not used for authentication if set to 0.

4. Example:

The following example specifies the IP address (**192.168.1.100**) of the remote radius server host and assigns authentication and accounting

destination port number (**1812**):

```
switch_a(config)#radius-server host 192.168.1.100 auth-port 1812
switch_a(config)#
```

Secret Key:

1. Command Mode: Configure mode

Logon to Configure Mode (Configure Terminal Mode).

The **switch_a(config)#** prompt will show on the screen.

```
switch_a(config)#
```

2. Usage:

Use this command to set the shared secret key between a Radius server and a client.

3. Command Syntax:

(no) radius-server host IP-ADDRESS key KEY

IP-ADDRESS A.B.C.D specifies the IP address of the radius server host.

KEY specifies the secret key shared among the radius server and the 802.1x client.

4. Example:

The following example specifies the IP address (**192.168.1.100**) of the remote radius server host and set the secret key (**ipi**) shared among the radius server and the 802.1x client:

```
switch_a(config)#radius-server host 192.168.1.100 key ipi
switch_a(config)#
```

Timeout:

1. Command Mode: Configure mode

Logon to Configure Mode (Configure Terminal Mode).

The **switch_a(config)#** prompt will show on the screen.

```
switch_a(config)#
```

2. Usage:

Use this command to specify the number of seconds a Switch waits for a reply to a radius request before retransmitting the request.

3. Command Syntax:

radius-server timeout SEC

no radius-server timeout

SEC <1-1000> The number of seconds for a Switch to wait for a server host to reply before timing out. Enter a value in the range 1 to 1000.

4. Example:

The following example specifies **20** seconds for the Switch to wait for a server host to reply before timing out:

```
switch_a(config)#radius-server timeout 20
switch_a(config)#
```

Retransmit:

1. Command Mode: Configure mode
Logon to Configure Mode (Configure Terminal Mode).

The **switch_a(config)#** prompt will show on the screen.

```
switch_a(config)#
```

2. Usage:

Use this command to specify the number of times the Switch transmits each radius request to the server before giving up.

3. Command Syntax:

radius-server retransmit RETRIES

no radius-server retransmit

RETRIES <1-100> Specifies the retransmit value. Enter a value in the range 1 to 100.

4. Example:

The following example specifies the retransmit value **12**:

```
switch_a(config)#radius-server retransmit 12
switch_a(config)#
```

Port Authentication

Authentication State:

1. Command Mode: Interface mode
Logon to Configure Mode (Configure Terminal Mode).

Then logon to Interface mode.

fe1 means port 1.

The **switch_a(config-if)#** prompt will show on the screen.

```
switch_a(config)#interface fe1
switch_a(config-if)#
```

2. Usage:

Use **dot1x reauthentication** command to enable reauthentication on a port.

Use **no dot1x reauthentication** command to disable reauthentication on a port.

3. Command Syntax:

(no) dot1x reauthentication

4. Example:

The following example specifies to enable reauthentication on the interface fe1 (port 1):

```
switch_a(config)#interface fe1
switch_a(config-if)#dot1x reauthentication
switch_a(config-if)#
```

Port Control:

1. Command Mode: Interface mode
Logon to Configure Mode (Configure Terminal Mode).
Then logon to Interface mode.
fe1 means port 1.

The **switch_a(config-if)#** prompt will show on the screen.

```
switch_a(config)#interface fe1
switch_a(config-if)#
```

2. Usage:

Use this command to force a port state.

Use **no dot1x port-control** command to remove a port from the 802.1x management.

3. Command Syntax:

dot1x port-control auto | force-authorized | force-unauthorized

no dot1x port-control

auto Specify to enable authentication on port.

force-authorized Specify to force a port to always be in an authorized state.

force-unauthorized Specify to force a port to always be in an unauthorized state.

4. Example:

The following example specifies to enable authentication on the interface fe1 (port 1):

```
switch_a(config)#interface fe1
switch_a(config-if)#dot1x port-control auto
switch_a(config-if)#
```

Periodic Reauthentication:

Reauthentication Period:

1. Command Mode: Interface mode
Logon to Configure Mode (Configure Terminal Mode).
Then logon to Interface mode.
fe1 means port 1.

The **switch_a(config-if)#** prompt will show on the screen.

```
switch_a(config)#interface fe1
```



```
switch_a(config-if)#
```

2. Usage:

Use this command to set the interval between reauthorization attempts.

Use **no dot1x timeout re-authperiod** command to delete the interval between reauthorization attempts.

3. Command Syntax:

```
dot1x timeout re-authperiod SECS
```

```
no dot1x timeout re-authperiod
```

SECS <1-4294967295> Specify the seconds between reauthorization attempts. The default time is 3600 seconds.

4. Example:

The following example specifies to set the interval **25** seconds between reauthorization attempts:

```
switch_a(config)#interface fe1  
switch_a(config-if)#dot1x timeout re-authperiod 25  
switch_a(config-if)#
```

Other Protocols

GVRP, IGMP Snooping, NTP, GMRP, DHCP Server

GVRP

GVRP:

1. Command Mode: Configure mode

Logon to Configure Mode (Configure Terminal Mode).

The **switch_a(config)#** prompt will show on the screen.

```
switch_a(config)#
```

2. Usage:

Use **set gvrp enable bridge** command to enable (set) and **set gvrp disable bridge** command to disable (reset) GVRP globally for the bridge instance. This command does not enable/disable GVRP in all ports of the bridge. After enabling GVRP globally, use the **set port gvrp enable** command to enable GVRP on individual ports of the bridge.

3. Command Syntax:

```
set gvrp enable bridge GROUP
```

```
set gvrp disable bridge GROUP
```

GROUP Bridge-group ID used for bridging.

4. Example:

The following example globally enables GVRP to bridge GROUP (1):

```
switch_a(config)#set gvrp enable bridge 1
switch_a(config)#
```

Dynamic VLAN creation:

1. Command Mode: Configure mode

Logon to Configure Mode (Configure Terminal Mode).

The **switch_a(config)#** prompt will show on the screen.

```
switch_a(config)#
```

2. Usage:

Use **set gvrp dynamic-vlan-creation enable bridge** command to enable and **set gvrp dynamic-vlan-creation disable bridge** command to disable dynamic VLAN creation for a specific bridge instance.

3. Command Syntax:

```
set gvrp dynamic-vlan-creation enable bridge GROUP
```

```
set gvrp dynamic-vlan-creation disable bridge GROUP
```

GROUP Bridge-group ID used for bridging.

4. Example:

The following example enables dynamic VLAN creation for bridge GROUP (1):

```
switch_a(config)#set gvrp dynamic-vlan-creation enable bridge 1
switch_a(config)#
```

Per port setting:

GVRP:

1. Command Mode: Configure mode

Logon to Configure Mode (Configure Terminal Mode).

The **switch_a(config)#** prompt will show on the screen.

```
switch_a(config)#
```

2. Usage:

Use **set port gvrp enable** command to enable and **set port gvrp disable** command to disable GVRP on a port or all ports in a bridge.

3. Command Syntax:

set port gvrp enable all/IFNAME

set port gvrp disable all/IFNAME

all All ports added to recently configured bridge.

IFNAME The name of the interface.

4. Example:

The following example enables GVRP on the interface fe1 (port 1):

```
switch_a(config)#set port gvrp enable fe1
switch_a(config)#
```

Per port setting:

GVRP applicant:

1. Command Mode: Configure mode

Logon to Configure Mode (Configure Terminal Mode).

The **switch_a(config)#** prompt will show on the screen.

```
switch_a(config)#
```

2. Usage:

Use this command to set the GVRP applicant state to normal or active.

3. Command Syntax:

set gvrp applicant state active/normal IFNAME

active Active state

normal Normal state

IFNAME Name of the interface.

4. Example:

The following example sets GVRP applicant state to active on the interface fe1 (port 1):

```
switch_a(config)#set gvrp applicant state active fe1
switch_a(config)#
```

Per port setting:

GVRP registration:

1. Command Mode: Configure mode

Logon to Configure Mode (Configure Terminal Mode).

The **switch_a(config)#** prompt will show on the screen.

```
switch_a(config)#
```

2. Usage:

Use this command to set GVRP registration to normal, fixed, and forbidden registration mode for a given port.

3. Command Syntax:

set gvrp registration normal IF_NAME

set gvrp registration fixed IF_NAME

set gvrp registration forbidden IF_NAME

normal Specify dynamic GVRP multicast registration and deregistration on the port.

fixed Specify the multicast groups currently registered on the switch are applied to the port, but any subsequent registrations or deregistrations do not affect the port. Any registered multicast groups on the port are not deregistered based on the GARP timers.

forbidden Specify that all GVRP multicasts are deregistered, and prevent any further GVRP multicast registration on the port.

IF_NAME The name of the interface.

4. Example:

The following example sets GVRP registration to fixed registration mode on the interface fe1 (port 1):

```
switch_a(config)#set gvrp registration fixed fe1
switch_a(config)#
```

IGMP Snooping

IGMP mode:

Querier:

1. Command Mode: Configure mode

Logon to Configure Mode (Configure Terminal Mode).

The **switch_a(config)#** prompt will show on the screen.

```
switch_a(config)#
```

2. Usage:

Use **ip igmp snooping querier** command to enable IGMP querier operation on a subnet (VLAN) when no multicast routing protocol is configured in the subnet (VLAN). When enabled, the IGMP Snooping querier sends out periodic IGMP queries for all interfaces on that VLAN.

Use the **no ip igmp snooping querier** command to disable IGMP querier configuration.

3. Command Syntax:

(no) ip igmp snooping querier

4. Example:

The following example enables IGMP snooping querier:

```
switch_a(config)# ip igmp snooping querier
switch_a(config)#
```

IGMP mode:

Passive:

1. Command Mode: Configure mode

Logon to Configure Mode (Configure Terminal Mode).

The **switch_a(config)#** prompt will show on the screen.

```
switch_a(config)#
```

2. Usage:

Use **ip igmp snooping** command to enable IGMP Snooping. This command is given in the Global Config mode. IGMP Snooping is enabled at the switch level.

Use the **no ip igmp snooping** command to globally disable IGMP Snooping.

3. Command Syntax:

(no) ip igmp snooping enable

4. Example:

The following example enables IGMP snooping on the switch:

```
switch_a(config)# ip igmp snooping enable
switch_a(config)#
```

IGMP version:

1. Command Mode: Interface mode

Logon to Configure Mode (Configure Terminal Mode).

Then logon to Interface mode.

vlan1.1 means vlan 1.

The **switch_a(config-if)#** prompt will show on the screen.

```
switch_a(config)#interface vlan1.1
switch_a(config-if)#
```

2. Usage:

Use **ip igmp version** command to set the current IGMP protocol version on an interface.

To return to the default version, use the **no ip igmp version** command.

3. Command Syntax:

ip igmp version VERSION

no ip igmp version

VERSION IGMP protocol version number.

4. Example:

The following example sets the IGMP protocol version 3 on **vlan1.1**:

```
switch_a(config)#interface vlan1.1
switch_a(config-if)#ip igmp version 3
switch_a(config-if)#
```

Fast-leave:

1. Command Mode: Interface mode

Logon to Configure Mode (Configure Terminal Mode).

Then logon to Interface mode.

vlan1.1 means vlan 1.

The **switch_a(config-if)#** prompt will show on the screen.

```
switch_a(config)#interface vlan1.1
switch_a(config-if)#
```

2. Usage:

Use **ip igmp snooping fast-leave** command to enable IGMP Snooping fast-leave processing. Fast-leave processing is analogous to immediate leave processing; the IGMP group-membership is removed, as soon as an IGMP leave group message is received without sending out a group-specific query.

Use the **no ip igmp snooping fast-leave** command to disable fast-leave processing.

3. Command Syntax:

(no) ip igmp snooping fast-leave

4. Example:

The following example enables IGMP snooping fast-leave on **vlan1.1**:

```
switch_a(config)#interface vlan1.1
switch_a(config-if)#ip igmp snooping fast-leave
switch_a(config-if)#
```

IGMP querier:

Query-interval:

1. Command Mode: Interface mode
Logon to Configure Mode (Configure Terminal Mode).
Then logon to Interface mode.
vlan1.1 means vlan 1.

The **switch_a(config-if)#** prompt will show on the screen.

```
switch_a(config)#interface vlan1.1
switch_a(config-if)#
```

2. Usage:

Use **ip igmp query-interval** command to configure the frequency of sending IGMP host query messages.

To return to the default frequency, use the **no ip igmp query-interval** command.

3. Command Syntax:

ip igmp query-interval INTERVAL

no ip igmp query-interval

INTERVAL <1-18000> Frequency (in seconds) at which IGMP host query messages are sent. Default: 125 seconds.

4. Example:

The following example changes the frequency of sending IGMP host-query messages to 2 minutes on **vlan1.1**:

```
switch_a(config)#interface vlan1.1
switch_a(config-if)#ip igmp query-interval 120
switch_a(config-if)#
```

IGMP querier:

Max-response-time:

1. Command Mode: Interface mode
Logon to Configure Mode (Configure Terminal Mode).
Then logon to Interface mode.
vlan1.1 means vlan 1.

The **switch_a(config-if)#** prompt will show on the screen.

```
switch_a(config)#interface vlan1.1
switch_a(config-if)#
```

2. Usage:

Use **ip igmp query-max-response-time** command to configure the maximum response time advertised in IGMP queries.

To restore to the default value, use the **no ip igmp query-max-response-time** command.

3. Command Syntax:

```
ip igmp query-max-response-time RESPONSETIME
```

```
no ip igmp query-max-response-time
```

RESPONSETIME <1-240> Maximum response time (in seconds) advertised in IGMP queries. Default: 10 seconds.

4. Example:

The following example configures a maximum response time of 8 seconds on **vlan1.1**:

```
switch_a(config)#interface vlan1.1
switch_a(config-if)#ip igmp query-max-response-time 8
switch_a(config-if)#
```

IGMP passive snooping:

Static mc router port:

1. Command Mode: Interface mode

Logon to Configure Mode (Configure Terminal Mode).

Then logon to Interface mode.

vlan1.1 means vlan 1.

The **switch_a(config-if)#** prompt will show on the screen.

```
switch_a(config)#interface vlan1.1
switch_a(config-if)#
```

2. Usage:

Use **ip igmp snooping mrouter interface** command to statically configure the specified VLAN constituent interface as a multicast router interface for IGMP Snooping in that VLAN.

Use the **no ip igmp snooping mrouter interface** command to remove the static configuration of the interface as a multicast router interface.

3. Command Syntax:

```
(no) ip igmp snooping mrouter interface IFNAME
```

IFNAME Specify the name of the interface

4. Example:

The following example shows interface fe1 (port 1) statically configured to be a multicast router interface on **vlan1.1**:

```
switch_a(config)#interface vlan1.1
switch_a(config-if)#ip igmp snooping mrouter interface fe1
switch_a(config-if)#
```

IGMP passive snooping:

Report suppression:

1. Command Mode: Interface mode

Logon to Configure Mode (Configure Terminal Mode).

Then logon to Interface mode.

vlan1.1 means vlan 1.

The **switch_a(config-if)#** prompt will show on the screen.

```
switch_a(config)#interface vlan1.1
switch_a(config-if)#
```

2. Usage:

Use **ip igmp snooping report-suppression** command to enable report suppression for IGMP versions 1 and 2.

Use the **no ip igmp snooping report-suppression** command to disable report suppression.

3. Command Syntax:

(no) ip igmp snooping report-suppression

4. Example:

The following example enables report suppression for IGMPv2 reports on **vlan1.1**:

```
switch_a(config)#interface vlan1.1
switch_a(config-if)#ip igmp version 2
switch_a(config-if)#ip igmp snooping report-suppression
switch_a(config-if)#
```

Passive Mode Forwarding Port:

1. Command Mode: Configure mode

Logon to Configure Mode (Configure Terminal Mode).

The **switch_a(config)#** prompt will show on the screen.

```
switch_a(config)#
```

2. Usage:

Use this command to forward multicast packet to interface before the interface receiving IGMP query in passive mode.

3. Command Syntax:

ip igmp snooping passive-forward LINE | none | all

LINE Interface name list, ex: fe1-fe3, fe5.

none Not forward multicast packet to any interface.

all Forward multicast packet to all interfaces.

4. Example:

The following example forwards multicast packet to interfaces fe1-fe3 and

fe5:

```
switch_a(config)# ip igmp snooping passive-forward fe1-fe3, fe5
switch_a(config)#
```

NTP

NTP Status:

1. Command Mode: Configure mode

Logon to Configure Mode (Configure Terminal Mode).

The **switch_a(config)#** prompt will show on the screen.

```
switch_a(config)#
```

2. Usage:

Use **ntp enable** command to enable NTP for the Switch.

Use **no ntp enable** command to disable NTP for the Switch.

3. Command Syntax:

(no) ntp enable

4. Example:

The following example enables NTP for the Switch:

```
switch_a(config)#ntp enable
switch_a(config)#
```

NTP Server:

1. Command Mode: Configure mode

Logon to Configure Mode (Configure Terminal Mode).

The **switch_a(config)#** prompt will show on the screen.

```
switch_a(config)#
```

2. Usage:

Use this command to specify the IP address or Domain name of NTP server.

3. Command Syntax:

ntp server IP-ADDRESS | DOMAIN-NAME

IP-ADDRESS A.B.C.D specifies the IP address of NTP server.

DOMAIN-NAME Specifies the Domain name of NTP server.

4. Example:

The following example specifies the IP address (**192.168.1.100**) of NTP server:

```
switch_a(config)#ntp server 192.168.1.100
switch_a(config)#
```

Sync Time:

1. Command Mode: Configure mode

Logon to Configure Mode (Configure Terminal Mode).

The **switch_a(config)#** prompt will show on the screen.

```
switch_a(config)#
```

2. Usage:

Use **ntp sync-time** command to synchronize time with NTP server.

3. Command Syntax:

ntp sync-time

4. Example:

The following example synchronizes time with NTP server:

```
switch_a(config)#ntp sync-time
switch_a(config)#
```

Time Zone:

1. Command Mode: Configure mode

Logon to Configure Mode (Configure Terminal Mode).

The **switch_a(config)#** prompt will show on the screen.

```
switch_a(config)#
```

2. Usage:

Use this command to to set time zone.

3. Command Syntax:

clock timezone TIMEZONE

TIMEZONE Specifies the time zone. (Please refer the Appendix B)

4. Example:

The following example sets time zone (Canada/Yukon):

```
switch_a(config)#clock timezone YST9YDT
switch_a(config)#
```

Polling Interval:

1. Command Mode: Configure mode

Logon to Configure Mode (Configure Terminal Mode).

The **switch_a(config)#** prompt will show on the screen.

```
switch_a(config)#
```

2. Usage:

Use this command to specify the polling interval.

3. Command Syntax:

ntp polling-interval MINUTE

MINUTE <1-10080> The polling interval. Enter a value in the range 1 to 10080 minutes.

4. Example:

The following example specifies the polling interval **60** minutes:

```
switch_a(config)#ntp polling interval 60
switch_a(config)#
```

Daylight Saving Mode:

1. Command Mode: Configure mode

Logon to Configure Mode (Configure Terminal Mode).

The **switch_a(config)#** prompt will show on the screen.

```
switch_a(config)#
```

2. Usage:

Use this command to enable daylight saving.

Use **no clock summer-time** command to disable daylight saving.

3. Command Syntax:

clock summer-time TIMEZONE weekday WEEK DAY MONTH HOUR
MINUTE WEEK DAY MONTH HOUR MINUTE OFFSET

TIMEZONE Specifies the daylight saving timezone.

WEEK <1-5> Specifies starting/ending week of daylight savings time.

DAY <0-6> Specifies from Sunday to Saturday.

MONTH <1-12> Specifies from January to December.

HOUR <0-23> Specifies from 0 to 23.

MINUTE <0-59> Specifies from 0 to 59.

OFFSET <1-1440> Specifies from 1 to 1440 minutes.

clock summer-time TIMEZONE date DAY MONTH HOUR MINUTE DAY
MONTH HOUR MINUTE OFFSET

TIMEZONE Specifies the daylight saving timezone.

DAY <1-31> Specifies from 1 to 31.

MONTH <1-12> Specifies from January to December.

HOUR <0-23> Specifies from 0 to 23.

MINUTE <0-59> Specifies from 0 to 59.

OFFSET <1-1440> Specifies from 1 to 1440 minutes.

no clock summer-time

4. Example:

The following example sets clock summer-time TIMEZONE (**onehour**) as daylight saving offset 60 minutes from 4 April AM0:00 to 31 October AM0:00:

```
switch_a(config)#clock summer-time onehour date 4 4 0 0 31 10 0 0 60
switch_a(config)#
```

GMRP

Clear GMRP Statistics:

1. Command Mode: Privileged Exec mode
Logon to Privileged Exec Mode (Enable Mode).

The **switch_a#** prompt will show on the screen.

```
switch_a#
```

2. Usage:

Use this command to clear GMRP statistics for a given VLAN or all the VLANs configured on the Layer-2 switch. This default clearing is for all the configured VLANs.

3. Command Syntax:

clear gmrp statistics [all | vlanid VLANID] bridge BRIDGE_NAME

all Clear GMRP statistics for all the VLANs.

VLANID vlanid <1 to 4094> Clear GMRP statistics for the particular VLAN ID.

BRIDGE_NAME Bridge instance name.

4. Example:

The following example clears the GMRP statistics for VLAN 12 on bridge 1:

```
switch_a#clear gmrp statistics vlan 12 bridge 1  
switch_a#
```

The following example clears the GMRP statistics for all the configured VLANs on bridge 1:

```
switch_a#clear gmrp statistics all bridge 1  
switch_a#
```

Set GMRP:

1. Command Mode: Configure mode
Logon to Configure Mode (Configure Terminal Mode).

The **switch_a(config)#** prompt will show on the screen.

```
switch_a(config)#
```

2. Usage:

Use this command to enable/disable GMRP globally on a particular bridge. This command does not enable/disable GMRP in all ports of the bridge. After enabling GMRP globally, use the **set port gmrp** command to enable GMRP on individual ports of the bridge. GMRP cannot be enabled if IGMP Snooping is enabled, or if GMRP has already been configured for a particular VLAN.

3. Command Syntax:

set gmrp enable | disable bridge BRIDGE_NAME
 enable Enable GMRP on Layer-2 switch.
 disable Disable GMRP on Layer-2 switch
 BRIDGE_NAME The text string to use for the name of the bridge.

4. Example:

The following example enables GMRP on a Layer-2 switch for bridge 1:

```
switch_a(config)#set gmrp enable bridge 1
switch_a(config)#
```

Set Port GMRP:

1. Command Mode: Configure mode

Logon to Configure Mode (Configure Terminal Mode).

The **switch_a(config)#** prompt will show on the screen.

```
switch_a(config)#
```

2. Usage:

Use this command to enable/disable GMRP on a particular port in all VLANs or all ports in a bridge. GMRP on a port cannot be enabled for all VLANs if GMRP has already been configured for a particular VLAN for the port.

3. Command Syntax:

set port gmrp enable | disable all | IF_NAME
 enable Enable GMRP on Layer-2 switch port
 disable Disable GMRP on Layer-2 switch port
 all All ports added to recently configured bridge
 IF_NAME Specify the name of the interface.

4. Example:

The following example enables GMRP on interface fe1 (port 1):

```
switch_a(config)#set port gmrp enable fe1
switch_a(config)#
```

The following example enables GMRP on all ports:

```
switch_a(config)#set port gmrp enable all
switch_a(config)#
```

GMRP Registration:

1. Command Mode: Configure mode

Logon to Configure Mode (Configure Terminal Mode).

The **switch_a(config)#** prompt will show on the screen.

```
switch_a(config)#
```

2. Usage:

Use this command to set GMRP registration type for all ports for a given bridge.

3. Command Syntax:

set gmrp registration normal | fixed | forbidden IF_NAME

normal Specify dynamic GMRP multicast registration and deregistration on the port.

fixed Specify the multicast groups currently registered on the switch are applied to the port, but any subsequent registrations or deregistrations do not affect the port. Any registered multicast groups on the port are not deregistered based on the GARP timers.

forbidden Specify that all GMRP multicasts are deregistered, and prevent any further GMRP multicast registration on the port.

IF_NAME Defines a text string used as the name of the interface; ASCII string from 1 to 16 characters.

4. Example:

The following example sets interface fe1 (port 1) to normal registration:

```
switch_a(config)#set gmrp registration normal fe1
switch_a(config)#
```

GMRP Forward All:

1. Command Mode: Configure mode

Logon to Configure Mode (Configure Terminal Mode).

The **switch_a(config)#** prompt will show on the screen.

```
switch_a(config)#
```

2. Usage:

Use this command to set the GMRP forward all option for an interface.

3. Command Syntax:

set gmrp fwdall enable | disable IF_NAME

IF_NAME Interface name.

4. Example:

The following example enables GMRP forwarding on a Layer-2 switch for interface fe1 (port 1):

```
switch_a(config)#set gmrp fwdall enable fe1
switch_a(config)#
```

Set GMRP Timer:

1. Command Mode: Configure mode

Logon to Configure Mode (Configure Terminal Mode).

The **switch_a(config)#** prompt will show on the screen.

```
switch_a(config)#
```

2. Usage:

Use this command to set the values for the GMRP Join, Leave, and Leaveall timers for a specified bridge. The default is the join timer (200 milliseconds); the leave timer is 600 milliseconds (ms); and the leaveall timer is 10000 milliseconds (ms).

3. Command Syntax:

```
set gmrp timer [join | leave | leaveall] TIMER_VALUE IF_NAME
```

join Type of timer

leave Type of timer

leaveall Type of timer

TIMER_VALUE Timervalue in centiseconds.

IF_NAME Specify the name of the interface.

4. Example:

The following example sets the join timers 100 centiseconds for interface fe1 (port 1):

```
switch_a(config)#set gmrp join timer 100 fe1
switch_a(config)#
```

DHCP Server

DHCP Binding Table:

1. Command Mode: Privileged Exec mode

Logon to Privileged Exec Mode (Enable Mode).

The **switch_a#** prompt will show on the screen.

```
switch_a#
```

2. Usage:

Use **show dhcp-server binding** command to display DHCP Server information.

3. Command Syntax:

```
show dhcp-server binding
```

4. Example:

The following example displays DHCP Server information:

```
switch_a#show dhcp-server binding
```

DHCP Server Status:

1. Command Mode: Interface mode

Logon to Configure Mode (Configure Terminal Mode).

Then logon to Interface mode.

vlan1.1 means vlan 1.

The **switch_a(config-if)#** prompt will show on the screen.

```
switch_a(config)#interface vlan1.1
switch_a(config-if)#
```

2. Usage:

Use **dhcp-server enable** command to start the DHCP Server.

Use **no dhcp-server enable** command to disable DHCP Server.

3. Command Syntax:

(no) dhcp-server enable

4. Example:

The following example starts the DHCP Server:

```
switch_a(config)#interface vlan1.1
switch_a(config-if)#dhcp-server enable
switch_a(config-if)#
```

DHCP Server Range:

1. Command Mode: Configure mode

Logon to Configure Mode (Configure Terminal Mode).

The **switch_a(config)#** prompt will show on the screen.

```
switch_a(config)#
```

2. Usage:

Use this command to set the default IP lease block for the DHCP Server.

3. Command Syntax:

dhcp-server range A.B.C.D A.B.C.D

A.B.C.D The default Start IP for the DHCP Server.

A.B.C.D The default End IP for the DHCP Server.

4. Example:

The following example sets the default IP lease block for the DHCP Server:

```
switch_a(config)#dhcp-server range 192.168.1.100 192.168.1.250
switch_a(config)#
```

DHCP Server Subnet-mask:

1. Command Mode: Configure mode

Logon to Configure Mode (Configure Terminal Mode).

The **switch_a(config)#** prompt will show on the screen.

```
switch_a(config)#
```

2. Usage:

Use this command to set the default subnet mask for the DHCP Server.
Use the no form of this command to remove this setting.

3. Command Syntax:

```
dhcp-server subnet-mask A.B.C.D
```

```
no dhcp-server subnet-mask
```

A.B.C.D The default subnet mask for the DHCP Server.

4. Example:

The following example sets the default subnet mask for the DHCP Server:

```
switch_a(config)#dhcp-server subnet-mask 255.255.255.0  
switch_a(config)#
```

DHCP Server Gateway:

1. Command Mode: Configure mode

Logon to Configure Mode (Configure Terminal Mode).

The **switch_a(config)#** prompt will show on the screen.

```
switch_a(config)#
```

2. Usage:

Use this command to set the default gateway for the DHCP Server.

Use the no form of this command to remove this setting.

3. Command Syntax:

```
dhcp-server gateway A.B.C.D
```

```
no dhcp-server gateway
```

A.B.C.D The default gateway for the DHCP Server.

4. Example:

The following example sets the default gateway for the DHCP Server:

```
switch_a(config)#dhcp-server gateway 192.168.1.254  
switch_a(config)#
```

DHCP Server DNS:

1. Command Mode: Configure mode

Logon to Configure Mode (Configure Terminal Mode).

The **switch_a(config)#** prompt will show on the screen.

```
switch_a(config)#
```

2. Usage:

Use this command to set the default DNS for the DHCP Server.

Use the no form of this command to remove this setting.

3. Command Syntax:

dhcp-server dns 1 | 2 A.B.C.D

no dhcp-server dns 1 | 2

A.B.C.D The default DNS for the DHCP Server.

4. Example:

The following example sets the default DNS for the DHCP Server:

```
switch_a(config)#dhcp-server dns 1 192.168.1.20
switch_a(config)#
```

DHCP Server Lease Time:

1. Command Mode: Configure mode

Logon to Configure Mode (Configure Terminal Mode).

The **switch_a(config)#** prompt will show on the screen.

```
switch_a(config)#
```

2. Usage:

Use this command to set the default lease time for the DHCP Server. Use the value 0 to reset this setting.

3. Command Syntax:

dhcp-server lease-time <0-86400>

<0-86400> The default lease time for the DHCP Server (default: 86400).

4. Example:

The following example sets the default lease time for the DHCP Server:

```
switch_a(config)#dhcp-server lease-time 86400
switch_a(config)#
```

Specifications

| | |
|---|---|
| Applicable Standards | IEEE 802.3 10Base-T IEEE 802.3u 100Base-TX, 100Base-FX IEEE 802.3ab 1000Base-T IEEE 802.3z 1000Base-SX/LX |
| Switching Method | Store-and-Forward |
| Forwarding Rate | 10 / 20Mbps half / full-duplex 100 / 200Mbps half / full-duplex 200Mbps full-duplex 2000Mbps full-duplex |
| Performance | 14,880pps for 10Mbps 148,810pps for 100Mbps 1,488,100pps for 1000Mbps |
| Cable | 10Base-T 2-pair UTP/STP Cat. 3, 4, 5 Up to 100m (328ft) 100Base-TX 2-pair UTP/STP Cat. 5 Up to 100m (328ft) 1000Base-T 4-pair UTP/STP Cat. 5 Up to 100m (328ft) 100Base-FX MMF (50 or 62.5µm), SMF (9 or 10µm) 1000Base-SX/LX MMF (50 or 62.5µm), SMF (9 or 10µm) |
| LED Indicators | Per unit – Power status (Power 1, Power 2, Power 3) Per port – 10/100TX, 100FX: LINK/ACT 1000SX/LX: LINK/ACT |
| Dimensions | 65mm (W) x 125mm (D) x 145mm (H) (2.56" (W) x 4.92" (D) x 5.71" (H)) |
| Net Weight | 1Kg (2.2lbs.) |
| Power Input | DC Jack: 12VDC, External AC/DC required Terminal Block: 12-48VDC |
| Operating Voltage & Max. Current Consumption | 0.92A @ 12VDC, 0.46A @ 24VDC, 0.23A @ 48VDC |
| Power Consumption | 11W Max. |
| Operating Temperature | -10°C to 60°C (14°F to 140°F) Tested for functional operation @ -20°C to 70°C (-4°F to 158°F) |
| Storage Temperature | -40°C to 85°C (-40°F to 185°F) |
| Humidity | 5%-95% non-condensing |
| EMI | FCC Part 15, Class A EN61000-6-4: EN55022, EN61000-3-2, EN61000-3-3 |
| EMS | EN61000-6-2: EN61000-4-2 (ESD Standard) EN61000-4-3 (Radiated RFI Standards) EN61000-4-4 (Burst Standards) EN61000-4-5 (Surge Standards) EN61000-4-6 (Induced RFI Standards) EN61000-4-8 (Magnetic Field Standards) |

| | |
|--------------------------------------|--|
| Environmental Test Compliance | IEC60068-2-6 Fc (Vibration Resistance) IEC60068-2-27 Ea (Shock) IEC60068-2-32 Ed (Free Fall) |
|--------------------------------------|--|

Appendix A

DB9 DCE pin assignment

| Pin no. | Name | RS232 Signal name |
|---------|------|---------------------|
| 1 | DCD | Data Carrier detect |
| 2 | RxD | Received data |
| 3 | TxD | Transmit data |
| 4 | --- | N/C |
| 5 | GND | Signal ground |
| 6 | DSR | Data set Ready |
| 7 | --- | N/C |
| 8 | CTS | Clear to send |
| 9 | --- | N/C |

Appendix B

| Time Zone | Country and City Lists |
|--------------------|--|
| Europe | |
| MEZ-1MESZ | Europe/Vienna, Europe/Berlin, Europe/Zurich |
| MET-1METDST | Africa/Tunis, CET, MET, Europe/Tirane, Europe/Andorra, Europe/Brussels, Europe/Prague, Europe/Copenhagen, Europe/Paris, Europe/Gibraltar, Europe/Budapest, Europe/Rome, Europe/Vaduz, Europe/Luxembourg, Europe/Malta, Europe/Monaco, Europe/Amsterdam, Europe/Oslo, Europe/Warsaw, Europe/Belgrade, Europe/Madrid, Africa/Ceuta, Europe/Stockholm, Europe/Vatican, Europe/San_Marino, Arctic/Longyearbyen, Atlantic/Jan_Mayen, Europe/Ljubljana, Europe/Sarajevo, Europe/Skopje, Europe/Zagreb, Europe/Bratislava, Poland |
| EET-2EETDST | Asia/Nicosia, EET, Europe/Minsk, Europe/Sofia, Europe/Athens, Europe/Vilnius, Europe/Chisinau, Europe/Istanbul, Europe/Kiev, Europe/Uzhgorod, Europe/Zaporozhye, Europe/Nicosia, Asia/Istanbul, Europe/Tiraspol, Turkey |
| GMT0BST | Europe/London, Europe/Dublin, Eire, Europe/Belfast, GB, GB-Eire |
| WET0WETDST | WET, Atlantic/Faeroe, Atlantic/Madeira, Atlantic/Canary |
| PWT0PST | Europe/Lisbon, Portugal |
| MST-3MDT | Europe/Moscow, W-SU |
| EUT-1EUTDST | America/Scoresbysund, Atlantic/Azores |
| EUT-2EUTDST | Asia/Beirut, Europe/Simferopol |
| EUT-3EUTDST | Asia/Tbilisi |
| EUT-4EUTDST | Europe/Samara |
| EUT-6EUTDST | Asia/Almaty, Asia/Qyzylorda |
| EUT-8EUTDST | Asia/Ulaanbaatar |
| Russian Federation | |
| RFT-2RFTDST | Europe/Kaliningrad |
| RFT-3RFTDST | Europe/Moscow |
| RFT-4RFTDST | Asia/Yerevan, Asia/Baku, Asia/Oral, Asia/Ashkhabad |

| | |
|---------------------------------|---|
| RFT-5RFTDST | Asia/Aqtobe, Asia/Aqtau, Asia/Bishkek, Asia/Yekaterinburg |
| RFT-6RFTDST | Asia/Omsk, Asia/Novosibirsk |
| RFT-7RFTDST | Asia/Hovd, Asia/Krasnoyarsk |
| RFT-8RFTDST | Asia/Irkutsk, Asia/Chungking, Asia/Ulan_Bator |
| RFT-9RFTDST | Asia/Choibalsan, Asia/Yakutsk |
| RFT-10RFTDST | Asia/Vladivostok |
| RFT-11RFTDST | Asia/Sakhalin, Asia/Magadan |
| RFT-12RFTDST | Asia/Kamchatka, Asia/Anadyr |
| North America | |
| PST8PDT | America/Los_Angeles, US/Pacific-New, PST8PDT, US/Pacific, SystemV/PST8PDT |
| MST7MDT | America/Denver, America/Boise, America/Cambridge_Bay, America/Shiprock, MST7MDT, Navajo, US/Mountain, SystemV/MST7MDT |
| MST7 | America/Phoenix, MST, US/Arizona, SystemV/MST7 |
| CST6CDT | America/Chicago, America/North_Dakota/Center, America/Menominee, America/Costa_Rica, America/Managua, CST6CDT, US/Central, SystemV/CST6CDT |
| EST5EDT | America/New_York, America/Kentucky/Louisville, America/Kentucky/Monticello, America/Detroit, America/Pangnirtung, America/Louisville, EST5EDT, US/Eastern, US/Michigan, SystemV/EST5EDT |
| AST4ADT | America/Thule, Atlantic/Bermuda, SystemV/AST4ADT |
| EST5 | America/Coral_Harbour, America/Cayman, America/Jamaica, America/Panama, EST, Jamaica, SystemV/EST5 |
| AST10ADT | America/Adak, America/Atka, US/Aleutian |
| YST9YDT | Canada/Yukon |
| NST3:30NDT | America/St_Johns, Canada/Newfoundland |
| NAST3NADT | America/Godthab, America/Miquelon |
| NAST9NADT | Pacific/Pitcairn, America/Juneau, America/Yakutat, America/Anchorage, America/Nome, US/Alaska, SystemV/YST9YDT, SystemV/PST8 |
| South America & Central America | |
| TTST4 | America/Port_of_Spain |
| SAT3 | America/Argentina/Buenos_Aires, |

| | |
|---------------|--|
| | America/Argentina/Cordoba, America/Argentina/Tucuman, America/Argentina/La_Rioja, America/Argentina/San_Juan, America/Argentina/Jujuy, America/Argentina/Catamarca, America/Argentina/Mendoza, America/Argentina/Rio_Gallegos, America/Argentina/Ushuaia, America/Argentina/ComodRivadavia, America/Buenos_Aires, America/Cordoba, America/Jujuy, America/Mendoza |
| EBST3EBDT | America/Fortaleza, America/Recife, America/Araguaina, America/Maceio, America/Bahia, America/Sao_Paulo, America/Cuiaba, America/Montevideo, America/Catamarca, America/Rosario, Brazil/East |
| WBST4WBDT | America/Campo_Grande, America/Boa_Vista, America/Manaus, Atlantic/Stanley, America/Asuncion, Brazil/West |
| ACRE5 | America/Rio_Branco, America/Porto_Acre, Brazil/Acre |
| NORO2 | America/Noronha, Brazil/DeNoronha |
| CST4CDT | Antarctica/Palmer, America/Santiago, Chile/Continental |
| EIST6EIDT | Pacific/Easter, Chile/EasterIsland |
| Asia | |
| MST-8 | Asia/Kuala_Lumpur, Asia/Kuching |
| CST-8 | Asia/Harbin, Asia/Shanghai, Asia/Chongqing, Asia/Urumqi, Asia/Kashgar, Asia/Hong_Kong, Asia/Macau, Asia/Macao, Hongkong, PRC, ROC |
| Oceania | |
| CST-9:30CDT | Australia/Adelaide, Australia/Broken_Hill, Australia/South, Australia/Yancowinna |
| EST-10EDT | Australia/Brisbane, Australia/Lindeman, Australia/Currie, Australia/Melbourne, Australia/Sydney, Australia/ACT, Australia/Canberra, Australia/NSW, Australia/Queensland, Australia/Tasmania, Australia/Victoria |
| LHT-10:30LHDT | Australia/Lord_Howe, Australia/LHI |
| TST-10TDT | Australia/Hobart |
| NZST-12NZDT | Antarctica/McMurdo, Pacific/Auckland, |

| | |
|----------------|--|
| | Antarctica/South_Pole, NZ |
| CIST-12:45CIDT | Pacific/Chatham, NZ-CHAT |
| Africa | |
| SAST-2 | Africa/Maseru, Africa/Johannesburg, Africa/Mbabane |
| EST-2EDT | Africa/Cairo, Egypt |
| UAEST-4 | Asia/Dubai |
| IST-3IDT | Asia/Baghdad |
| JST-2JDT | Asia/Amman |
| SST-2SDT | Asia/Damascus |
| Universal | |
| UCT | Africa/Ouagadougou, Africa/Abidjan, Africa/Banjul, Africa/Accra, Africa/Conakry, Africa/Bissau, Africa/Monrovia, Africa/Bamako, Africa/Nouakchott, Africa/Casablanca, Africa/El_Aaiun, Atlantic/St_Helena, Africa/Sao_Tome, Africa/Dakar, Africa/Freetown, Africa/Lome, America/Danmarkshavn, Atlantic/Reykjavik, Etc/GMT, Etc/UTC, Etc/UCT, GMT, Etc/Universal, Etc/Zulu, Etc/Greenwich, Etc/GMT-0, Etc/GMT+0, Etc/GMT0, Africa/Timbuktu, GMT+0, GMT-0, GMT0, Greenwich, Iceland, UCT, UTC, Universal, Zulu |
| UCT1 | Atlantic/Cape_Verde, Etc/GMT+1 |
| UCT2 | Atlantic/South_Georgia, Etc/GMT+2 |
| UCT3 | Antarctica/Rothera, America/Belem, America/Cayenne, America/Paramaribo, Etc/GMT+3 |
| UCT4 | America/Anguilla, America/Antigua, America/Barbados, America/Dominica, America/Grenada, America/Guadeloupe, America/Martinique, America/Montserrat, America/Puerto_Rico, America/St_Kitts, America/St_Lucia, America/St_Vincent, America/Tortola, America/St_Thomas, America/Aruba, America/La_Paz, America/Porto_Velho, America/Curacao, America/Caracas, America/Guyana, Etc/GMT+4, America/Virgin, SystemV/AST4 |
| UCT5 | America/Guayaquil, America/Eirunepe, America/Lima, Etc/GMT+5 |
| UCT6 | America/Belize, America/El_Salvador, America/Tegucigalpa, Pacific/Galapagos, Etc/GMT+6 |

| | |
|----------|--|
| UCT7 | Etc/GMT+7 |
| UCT8 | Etc/GMT+8 |
| UCT9 | Pacific/Gambier, Etc/GMT+9, SystemV/YST9 |
| UCT10 | Pacific/Rarotonga, Pacific/Tahiti, Pacific/Fakaofu, Pacific/Johnston, Pacific/Honolulu, Etc/GMT+10, HST, US/Hawaii, SystemV/HST10 |
| UCT11 | Pacific/Niue, Pacific/Pago_Pago, Pacific/Apia, Pacific/Midway, Etc/GMT+11, Pacific/Samoa, US/Samoa |
| UCT-1 | Africa/Algiers, Africa/Luanda, Africa/Porto-Novo, Africa/Douala, Africa/Bangui, Africa/Ndjamena, Africa/Kinshasa, Africa/Brazzaville, Africa/Malabo, Africa/Libreville, Africa/Windhoek, Africa/Niamey, Africa/Lagos, Etc/GMT-1 |
| UCT-2 | Africa/Gaborone, Africa/Bujumbura, Africa/Lubumbashi, Africa/Tripoli, Africa/Blantyre, Africa/Maputo, Africa/Kigali, Africa/Lusaka, Africa/Harare, Etc/GMT-2, Libya |
| UCT-3 | Indian/Comoro, Africa/Djibouti, Africa/Asmera, Africa/Addis_Ababa, Africa/Nairobi, Indian/Antananarivo, Indian/Mayotte, Africa/Mogadishu, Africa/Khartoum, Africa/Dar_es_Salaam, Africa/Kampala, Antarctica/Syowa, Asia/Bahrain, Asia/Kuwait, Asia/Qatar, Asia/Riyadh, Asia/Aden, Etc/GMT-3 |
| UCT-4 | Indian/Mauritius, Indian/Reunion, Indian/Mahe, Asia/Muscat, Etc/GMT-4 |
| UCT-5 | Indian/Kerguelen, Indian/Maldives, Asia/Karachi, Asia/Dushanbe, Asia/Ashgabat, Asia/Samarkand, Asia/Tashkent, Etc/GMT-5 |
| UCT-5:45 | Asia/Katmandu |
| UCT-6 | Antarctica/Mawson, Antarctica/Vostok, Asia/Dhaka, Asia/Thimphu, Indian/Chagos, Asia/Colombo, Etc/GMT-6, Asia/Dacca, Asia/Thimbu |
| UCT-6:30 | Asia/Rangoon, Indian/Cocos |
| UCT-7 | Antarctica/Davis, Asia/Phnom_Penh, Asia/Jakarta, Asia/Pontianak, Asia/Vientiane, Asia/Bangkok, Asia/Saigon, Indian/Christmas, Etc/GMT-7 |
| UCT-8 | Antarctica/Casey, Asia/Brunei, Asia/Taipei, |

| | |
|------------------------|--|
| | Asia/Makassar, Asia/Manila, Asia/Singapore, Etc/GMT-8, Asia/Ujung_Pandang, Singapore |
| UCT-9 | Asia/Dili, Asia/Jayapura, Pacific/Palau, Etc/GMT-9 |
| UCT-9:30 | Australia/Darwin, Australia/North |
| UCT-10 | Antarctica/DumontDUrville, Pacific/Guam, Pacific/Saipan, Pacific/Truk, Pacific/Noumea, Pacific/Port_Moresby, Etc/GMT-10, Pacific/Yap |
| UCT-11 | Pacific/Ponape, Pacific/Kosrae, Pacific/Guadalcanal, Etc/GMT-11 |
| UCT-11:30 | Pacific/Norfolk |
| UCT-12 | Pacific/Fiji, Pacific/Tarawa, Pacific/Enderbury, Pacific/Majuro, Pacific/Kwajalein, Pacific/Nauru, Pacific/Tongatapu, Pacific/Funafuti, Pacific/Wake, Pacific/Efate, Pacific/Wallis, Etc/GMT-12, Kwajalein |
| UCT-13 | Etc/GMT-13 |
| JST | Asia/Tokyo, Japan |
| KST | Asia/Seoul, Asia/Pyongyang, ROK |
| UCT-3:30 | Asia/Tehran, Iran |
| UCT-4:30 | Asia/Kabul |
| IST-2IDT | Asia/Jerusalem, Asia/Gaza, Asia/Tel_Aviv, Israel |
| CST6MEX | America/Cancun, America/Merida, America/Monterrey, America/Mexico_City, America/Lima, Mexico/General |
| CST6 | America/Regina, America/Swift_Current, Canada/East-Saskatchewan, Canada/Saskatchewan, SystemV/CST6 |
| EET-2EETDST2 | Europe/Bucharest |
| EET-2EETDST3 | Europe/Tallinn, Europe/Helsinki, Europe/Riga, Europe/Mariehamn |
| EET-2EETDST2W2K | Europe/Istanbul |
| UCT-14 | Pacific/Kiritimati, Etc/GMT-14 |
| UCT9:30 | Pacific/Marquesas |
| UCT12 | Etc/GMT+12 |
| North America (Canada) | |
| PST8PDT_CA | America/Vancouver, America/Dawson_Creek, America/Whitehorse, America/Dawson, Canada/Pacific |
| MST7MDT_CA | America/Edmonton, America/Yellowknife, America/Inuvik, Canada/Mountain |
| CST6CDT_CA | America/Rainy_River, America/Winnipeg, |

| | |
|----------------------------------|---|
| | America/Rankin_Inlet, Canada/Central |
| EST5EDT_CA | America/Montreal, America/Toronto, America/Thunder_Bay, America/Nipigon, America/Iqaluit, Canada/Eastern |
| AST4ADT_CA | America/Goose_Bay, America/Halifax, America/Glace_Bay, Canada/Atlantic |
| North America (Cuba) | |
| EST5EDT_CU | America/Havana, Cuba |
| North America (Haiti) | |
| EST5EDT_HT | America/Nassau, America/Santo_Domingo, America/Port-au-Prince, America/Bogota |
| North America (Mexico) | |
| PST8PDT_MX | America/Tijuana, America/Ensenada, Mexico/BajaNorte |
| MST7MDT_MX | America/Chihuahua, America/Hermosillo, America/Mazatlan, Mexico/BajaSur |
| CST6CDT_MX | America/Guatemala |
| North America (Turks and Caicos) | |
| EST5EDT_TC | America/Grand_Turk |
| Additions Since 10g RTM | |
| EST5EDT_INDIANA | America/Indiana/Indianapolis, America/Indiana/Marengo, America/Indiana/Vevay, America/Fort_Wayne, America/Indianapolis, America/Indiana/Knox, America/Knox_IN, US/Indiana-Starke, US/East-Indiana |
| UCT-8_WA | Australia/Perth, Australia/West |