



EN

User Manual

**1/3" HDcctv Dome, WDR,
Day&Night, 1920x1080, 3-9mm,
3x AF Zoom, Infrared, 12/24V**

HDD-2080Z03IR D

Safety Precaution

- To prevent fire or shock hazard, do not expose the unit to rain or moisture.
- To prevent electric shocks and risk of fire hazards, do NOT use other than specific power source.

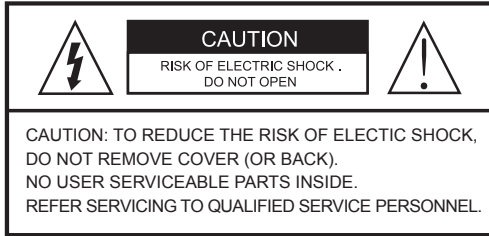

The symbol is intended to alert the user to the presence of uninsulated "dangerous voltage" within the product's enclosure that may be of sufficient magnitude to constitute a risk of electric shock to persons.



The symbol is intended to alert the user to the presence of important operating and maintenance(servicing) instructions in the literature accompanying the unit.

• Warning :

This equipment has been tested and found to comply with the limits for a Class A digital device, pursuant to part 15 of the FCC Rules. These limits are designed to provide reasonable protection against harmful interference when the equipment is operated in a commercial environment. This equipment generates, uses, and can radiate radio frequency energy and, if not installed and used in accordance with the instruction manual, may cause harmful interference to radio communications. Operation of this equipment in a residential area is likely to cause harmful interference in which case the user will be required to correct the interference at his own expense.

• Caution :

Any changes or modifications in construction of this device which are not expressly approved by the party responsible for compliance could void the user's authority to operate the equipment.

Mains power quality should be that of a typical commercial environment. If the user of the model requires continued operation during power mains interruptions, it is recommended that the model be powered from an uninterruptible power supply (UPS) or a battery.

Safety Precaution

NOTICE

- The image used in this instruction manual are processed to help comprehension and may differ from actual video of the camera.
- Avoid installing areas where has shock or vibration which results in the problems.
- Pay attention to safety when laying the connection cable and observe that the cable is not subjected to heavy loads, kinks or damage and no moisture can get in.
- Never open the device such as boards or lens.
The warranty becomes void if repairs are undertaken by unauthorized persons.
- Maintenance and repair have to be carried out only by authorized service centers.
- Use only a mild detergent to clean the housing.
- The camera should never be operated beyond the technical specifications.
This can lead to destruction.
- The camera should never be operated in water.

Contents

p.03~04

Safety Precaution

p.05

Contents

p.06~07

Features

p.07

Composition

p.08

Dimensions

p.09

Part Names

p.10~13

Installation Instructions

p.14~31

Operating Instructions

p.32~33

Specifications

Features

Key Features

- Full HD, 2Mega Pixel, EX-SDI CAMERA, 1920x1080(30p/25p)
- Extended long reach HD Solution
- Real time True WDR (Wide Dynamic Range) / 30fps
- Improved noise figure with the enhanced 3DNR
- Built-in f=3~9mm, F1.2~F2.1 Day&Night zoom lens
(Optical 3x Auto focus zoom / Digital 32x zoom)
- Dual Filter Switcher
- Focusing Status Indicator on Screen
 - ★ (Blue) Focusing in process
 - ☆ (White) Focusing Completed
- Various Zooming Technologies
 - Smart Motion Zoom (Automatic zoom in/out when motion is detected)
 - Pointing Zoom (which enables the programmable zooming at any area)
 - Preset Zoom
- Home Position setting
- Motion Detection, Privacy Mask, Defog, Sens-up(x32), BLC/HLC, H/V/HV Flip, Motion Deblur, Pixel Defect Compensation, Lens Refresh, Lens Initialize
- ID / TITLE / ZOOM RATIO DISPLAY
- Enhanced Sensitivity by DSS technology
- EX-SDI or HD-SDI switchable
- Top performance at low light sensitivity (Sens-up On)
- OSD menu & Video sub-out for easy installation & maintenance
- Circuit protection against faulty connection in power polarity
- Isolated power supply against ground loop problem
- Remote control via RS-485 (Pelco-D/P)
- Quick Firmware update via RS-485
- 2 High power LEDs
- Flush mount (Optional mounting accessories are choosable)
- Hard Coated Polycarbonate Clear bubble dome
- Built-in 3-Axis Gimbal
- Built-in cooling Fan & Heating function
- IP67 / IK10 Protection

Features

General Description

This camera realizes the natural and crisp image as you see the scene in front of you by adopting Auto Focus Full HD(1920x1080p) camera module. Highly detailed pictures can be achieved and color reproducibility deserves attention.

- With ICR mechanism,
 - Enhances its sensitivity about 10x at night time
 - Can accept the infrared light
- With 24VAC/12VDC dual power design,
 - Offers the flexibility of installation
 - Ensures the reliability

Composition

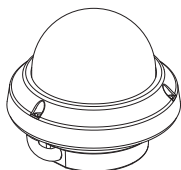

Dome Camera

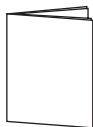

Operating Instruction

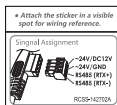

Cable Signal Sticker

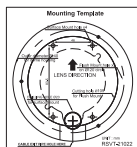

Mounting Template

Plastic Anchor:
6 x 30mm (3pcs)



Mounting Screw:
4 x 30mm (3pcs)



Connector fixing Screw:
2.5 x 5mm (1pc)



Torque Wrench:
3mm (1pc)



Video Sub-out Cable (1pc)

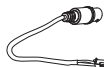

Wiring Connector (1pc)



Dimensions

(unit : mm)

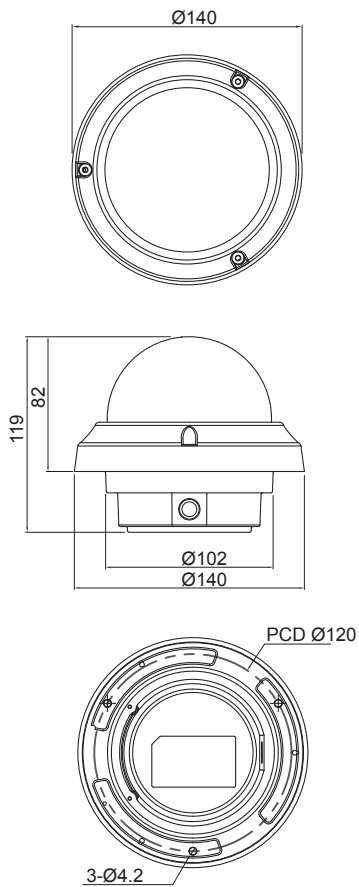

Part Names

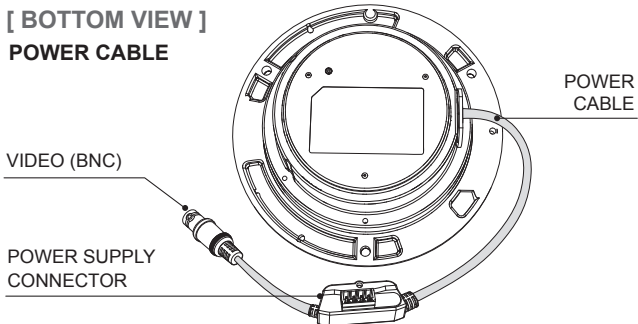
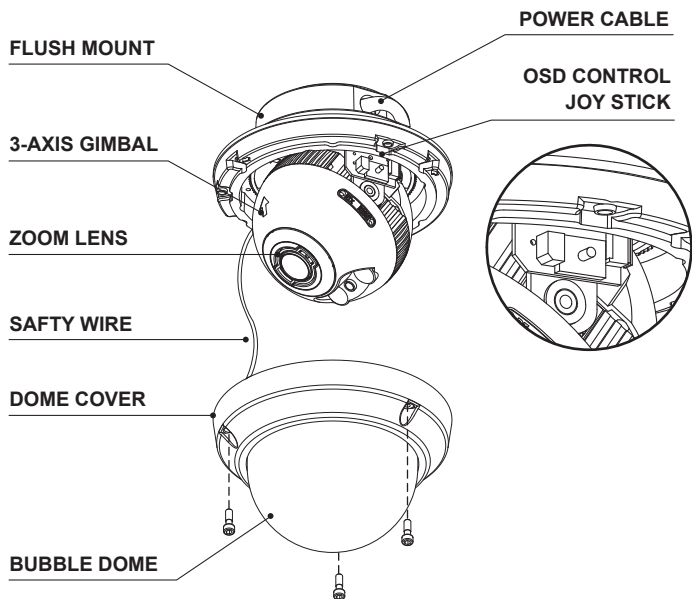

Installation Instructions

1. Locate the mounting template at the installation position and drill the ceiling or wall if needed.
2. Open the dome cover by loosening screws(4x12mm). Use the torque wrench supplied.
 - Place the dome base unit on pre-drilled position and fix it through using mounting screws (4x30mm).
 - Route the Power cable to the connecting place.
3. Set the camera's viewing angle.
4. Put the dome cover to the dome base unit and tighten the assembly screws.

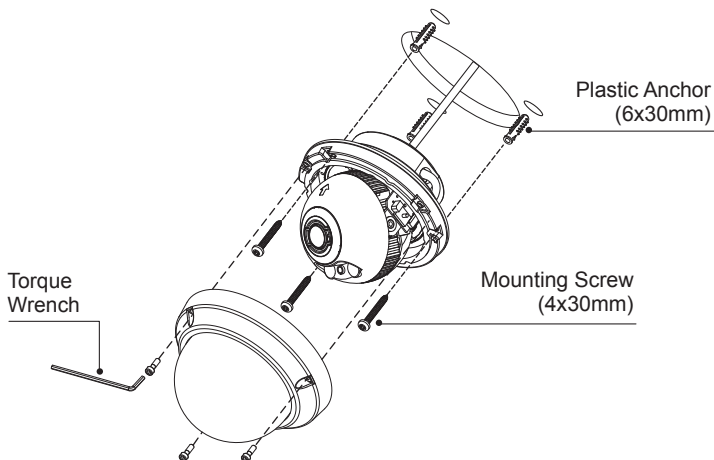

■ Optional Mounting Accessories

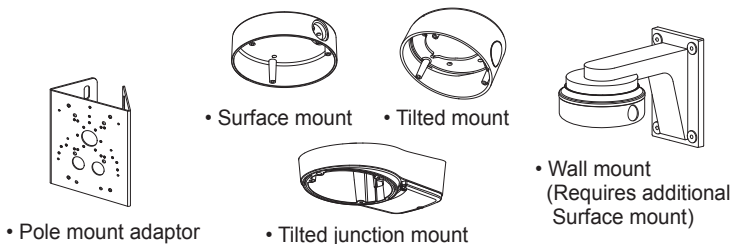

Installation Instructions

■ Option 1.

Installation with Flush mount / Tilted Junction mount

- ① Cable is unfixed on the Dome base.
- ② Connect the power cable to their respective connections.

** Refer to the instruction guide for Tilted Junction mount .*

■ Option 2.

Installation with Surface mount / Tilted mount

- ① Cable is unfixed on the Dome base.
- ② Fix the power supply connector with fixing screw as illustrated.
- ③ Tie up the BNC cable with cable holder.
- ④ Connect the wiring connector to their respective connections.

** Refer to the signal assignment for wiring connection.*

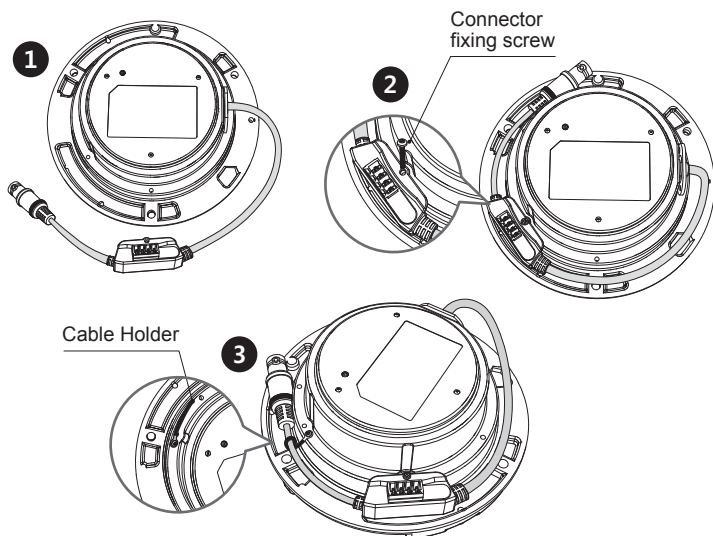

! CAUTION

- In the case of installation with Flush/ Surface/ Tilted mount, IP protection rating is not guaranteed.
- If power, Video connectors are exposed to water or rain, separate protection shield is essential.

Installation Instructions

Limit of pan & tilt

1) Pan limit:

Pan is limited to $\pm 173^\circ$. Do NOT force to rotate the gimbal over the limit to prevent from the internal damage.

2) Tilt limit:

Tilt is limited to 25° min $\sim 90^\circ$ max. with reference to the ceiling when the inclination of camera module is 0° , that is, the image is aligned horizontally.

3) Inclination limit (Horizontal image alignment):

Inclination limited to $\pm 50^\circ$ max.

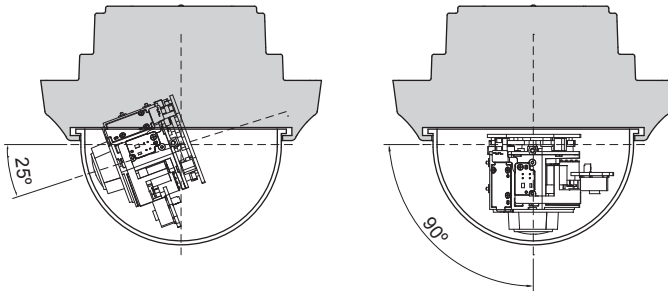

CAUTION

- Extreme care should be taken NOT to scratch the bubble dome surface while the camera installing or adjusting.
- Care should be taken the cable is NOT to be damaged, kinked or exposed in the hazardous area.
- Tighten enough the dome cover fixing screws so that there should be NO gap between Lens hood and clear bubble to avoid the light inflow from IR LEDs.

Installation Instructions

Power Supply Connections

Make sure the power is removed before the installation.

Camera can work with either 24AC or 12VDC, dual voltage power.

Primary and secondary grounds are completely isolated to avoid the possible ground-loop problems

In case that HD-SDI/EX-SDI Inputs are not supported in Monitor, please use HD-SDI/EX-SDI Converter to connect HD-SDI/EX-SDI cable with Monitor

Some computer monitors or TVs may not support 30p/25p.

In this case, HD-SDI/EX-SDI DVR which can convert the frame rate to 60p/50p is highly recommended.

Please check Specification of Monitor before installation.

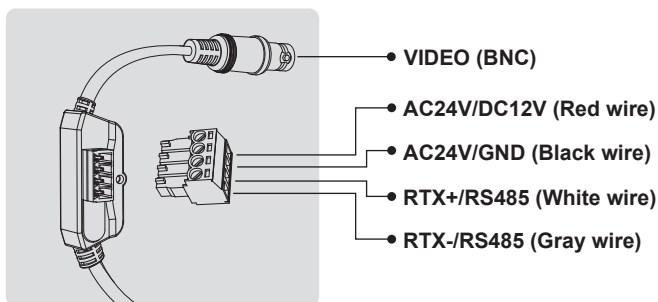

※ Attach the Signal Assignment Sticker in a visible spot for wiring reference.

• Attach the sticker in a visible spot for wiring reference.

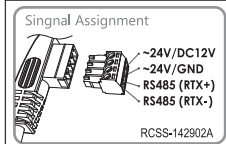

Operating Instructions

Using OSD controller

Setup menu can be accessed and controlled by OSD control joy stick on the side of camera unit.

Five commands are available with the joy stick.

The design of OSD could be different according to the Model.

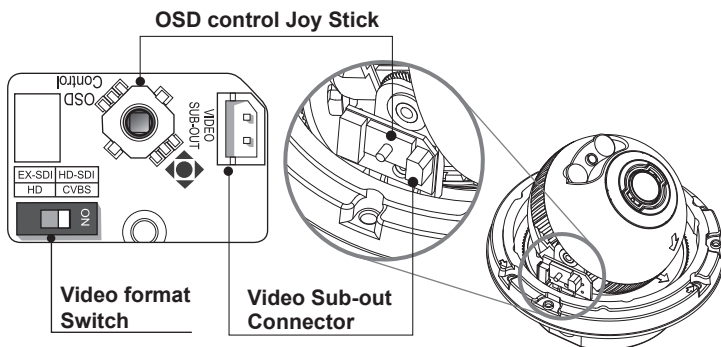

Description of the joystick operation

- 1) SET Key (●) : Access to the menu or enter the setting.
To enter the main menu, press the Set Key down for about 1.5sec
- 2) UP/DOWN Key (▲/▼) : Choose the desired sub-menu and to move the cursor up or down.
- 3) LEFT/RIGHT Key (◀/▶) : Set up the value of the selected menu.
Used to adjust the desired menu selection and to move the cursor left or right.
- 4) 'Ⓜ' denotes the long press down straightly for about 2 seconds



Description of the ZOOM&FOCUS adjustment

- | | |
|-----------------|-------------------|
| 1) ▲ : Zoom In | 3) ◀ : Focus Near |
| 2) ▼ : Zoom Out | 4) ▶ : Focus Far |

Operating Instructions

Set the video format according to system,
EX-SDI or HD-SDI

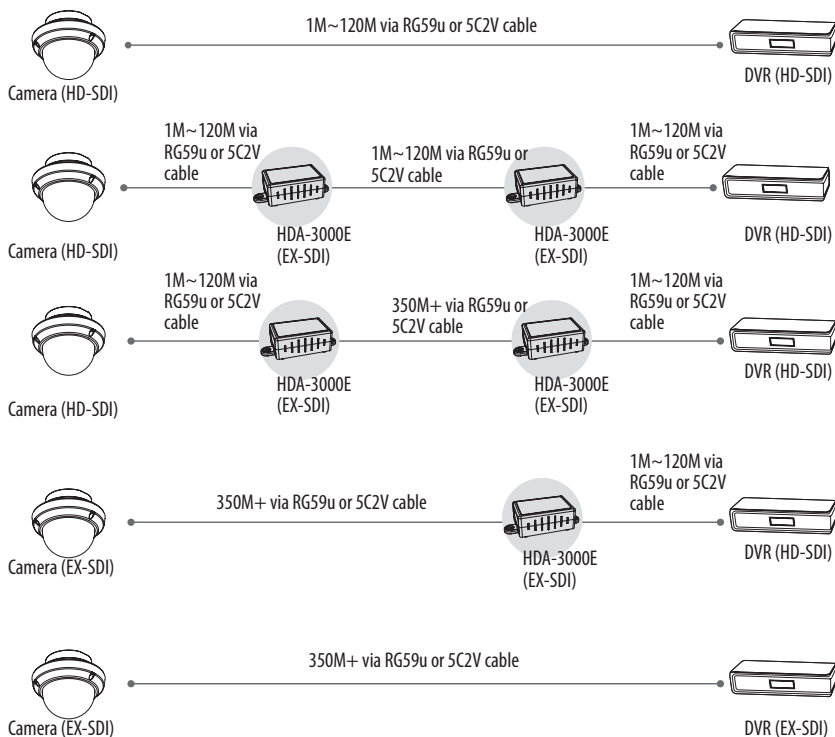

Operating Instructions

OSD menu Startup

Press '●' (OSD menu Joy stick key) down for about 2 seconds to access the setup menu mode.

Lens Initializing is strongly recommended at the first stage of setup menu control.
ZOOM/FOCUS > LENS INIT > Press the joystick '⬇' straight down for about 2 seconds.

MENU V5.xx	
▷ 1. ZOOM/FOCUS	⬇
2. EXPOSURE	⬇
3. SCENE ENHANCE	NORMAL
4. 3D-NR	MID
5. DAY/NIGHT	EXT
6. PICT ADJUST	⬇
7. SPECIAL	⬇
8. SYSTEM	⬇
9. EXIT	SAVE&EXIT ⬇

Direct Control menu



MAIN	DEFAULT	DESCRIPTION
ZOOM/FOCUS	-	Sets FOCUS and ZOOM relative fuctions.
EXPOSURE	-	Sets EXPOSURE MODE, BRIGHTNESS, SENS-UP, AGC and MOTION DEBLUR.
SCENE ENHANCE	NORMAL	SCENE ENHANCE provides the several ways to enhance the video in the various environments with the settings in NORMAL, WDR, D-WDR, BLC and HLC.
3D-NR	MID	Sets 3DNR level. LOW, MID, HIGH
DAY/NIGHT	EXT or AUTO	Sets DAY / NIGHT to EXT, AUTO, COLOR, B/W and COLOR D/N. Setting EXT mode for cameras with IR-LED, AUTO mode for none IR-LED camera types.
PICT ADJUST		Sets WHITE BAL, SHARPNESS, COLOR GAIN, GAMMA
SPECIAL		Sets MIRROR/FLIP, PRIVACY, MOTION, PIXEL DEFECT, TITLE SET, DISPLAY, DEFOG, POINTING ZOOM
SYSTEM		Sets TV SYSTEM, RESOLUTION, COMM.SETUP, LANGUAGE and FACTORY DEFAULT

Operating Instructions

EXIT

SAVE & EXIT – Exits the menu after saving the parameters.
EXIT – Exits the menu without saving the menu.

1. ZOOM/FOCUS

ZOOM / FOCUS	
▷ FOCUS MODE	ZOOM PUSH
D-ZOOM	OFF
HOME POSITION	OFF
LENS REFRESH	OFF
LENS INIT.	ON 
RETURN	RET 

1-1. FOCUS MODE (default: ZOOM PUSH)

: ZOOM PUSH, AUTO and MANUAL modes are available for focusing.

- ZOOM PUSH: Focusing is activated only when zoom in/out is working.
- AUTO: Focusing is always working.
- MANUAL: Focusing can only be adjusted by ▲, ▼ of OSD control joystick or the remote control via RS-485.

1-2. D-ZOOM (default: OFF)

: D-ZOOM(Digital zoom) is available up to 32x. D-ZOOM starts working when the optical zoom reaches its maximum tele-position. Zoom ratio is displayed on the right bottom corner of the monitor if SPECIAL>DISPLAY>ZOOM RATIO is set to ON.

1-3. HOME POSITION (default: OFF)

: Camera can be configured to return to pre-defined Zoom position automatically after certain period since ZOOM IN/OUT control is accomplished.

Home Position is recovered even after camera is re-initializing or Power ON/OFF.

- O-ZOOM RATIO: Sets the Optical ZOOM position as Home Position.
(x1.0~x3.0 / x1.0~x2.4)
- DURATION: When ZOOM IN/OUT control is accomplished, camera returns to pre-defined Zoom position after Duration time.
If SMART MOTION / PRESET ZOOM are running, duration for Home position starts after finishing SMART MOTION / PRESET ZOOM.

Operating Instructions

HOME POSITION	
▷ O-ZOOM RATIO	OZ X2.0
DURATION	5sec
RETURN	RET ↓

1-4. LENS REFRESH (default: OFF)

: LENS REFRESH can be set to 1~10day and performs the scheduled LENS Initialization automatically. Every initialization occurs when the time reaches the scheduled time after setup or power up. When LENS REFRESH initiates LENS Initialization, a notification 'LENS INITIALIZING...' appears on the top left corner on the monitor.

1-5. LENS INIT (default: ON 'P')

: Lens initialization is necessary during the installation or the regular operation to align the position data with the mechanical positions whose lens elements may move and deviate from its calibrated position by the shock or vibration, for example, during the transportation.

LENS INIT starts the lens initialization when pressing the joystick lever straight down for about 2 sec.

LENS INIT checks the positions for zoom and focus at both of the end positions and saves them for the references.

Lens initialization is automatically executed at power up.

CAUTION

- It is strongly necessary to execute LENS INIT in cases below;
 - 1) At the final step for the installation.
 - 2) When focus becomes out of control by the shock or vibration.

2. EXPOSURE

2-1. MODE (default: AUTO)

: Can set EXPOSURE MODE to AUTO, IRIS Priority, SHUT. Priority, MANUAL and Flickerless. SHUT. Priority, MANUAL and Flickerless modes disable SENS-UP and MOTION BLUR functions.

Operating Instructions

EXPOSURE

▷ MODE	AUTO
BRIGHTNESS DAY	: : : : : : 10
BRIGHTNESS NIGHT	: : : : 8
SENS-UP	OFF
AGC	: : : : : 10
MOTION DEBLUR	ON ↓
RETURN	RET

- **AUTO:** Optimizes the video level by controlling the iris and the shutter speed automatically.
- **IRIS Priority:** Selects to fix IRIS in a certain aperture and the video level is controlled by an automatic shutter control. Lower IRIS LEVEL will close more iris and increase the field of depth in the daytime but significantly decrease the low light performance. Too much low IRIS LEVEL will result in the foggy video by the diffusion from the lens iris.
- **SHUT. Priority:** Selects to fix SHUTTER speed in a certain speed and the video level is controlled by an automatic iris control. This mode is useful when the color rolling occurs under the fluorescent lighting. It is not recommendable at outdoor in the daytime.
- **MANUAL:** Iris and Shutter can be set to fix.
- **Flickerless :** Reduces the flicker in video when US(60Hz)/EU(50Hz) mode is used in 50Hz/60Hz fluorescent lighting respectively.

2-2. BRIGHTNESS DAY(default:10): Adjusts the brightness of day time video(0~20).

2-3. BRIGHTNESS NIGHT(default:10): Adjusts the brightness of night video(0~20).

2-4. SENS-UP (default: OFF)

: The brighter video can be obtained by increasing the exposure time in the night with SENS-UP. SENS-UP is the maximum integrations of frame by DSS (Digital Slow Shutter) in the low light.

- **AUTO:** SENS-UP is enabled or disabled automatically by the scene brightness. Higher SENS-UP can get the brighter video but the slower frame rates with motion blur and more white pixels. If set to AUTO, maximum integration limit for SENS-UP can be set to x2, x4, X8, x16, X32 in SENS-UP menu.
- **OFF:** Disables SENS-UP.

2-5. AGC (default: 10)

: AGC amplifies the video gain for brighter video but noise and white pixel accordingly. AGC level less than 10 disables AUTO in DAY/NIGHT.

Operating Instructions

2-6. MOTION DEBLUR (default: ON)

: ON enables MOTION DEBLUR to reduce the motion blur in a certain indoor environment. Noise or color rolling can increase.

3. SCENE ENHANCE

3-1. NORMAL (default)

: Optimized for the normal indoor and outdoor in the good lighting condition.

3-2. WDR

: Improves the visibility for the high bright area and the dark area by the double captures of image with LONG and SHORT exposures. With WDR ON, the frame rate becomes half by the double captures. WDR level can be selected from LOW, MID and HIGH. Care should be taken to select this mode because video may lose its quality in some environments by the over compensation.

※ CVBS video signal: Connecting 2nd video to CVBS port disables WDR function temporarily. It should be considered when installer adjusts the video with installation monitor via CVBS video signal.

3-3. D-WDR

: Improves the visibility by compensating the video gain for the dark area. Noise can increase in the dark area accordingly.

3-4. BLC

: Improves the visibility for the dark object by the bright back light. Outside area of BLC window can over saturate. BLC has a target window for compensation and its size and position can be set by H-POS, V-POS, H-SIZE and V-SIZE.

3-5. HLC

: Cuts out the highlight area with black mask and excludes it from compensation. Lower HLC LEVEL cut out video from the lower level.

4. 3D-NR

3D-NR is a very sophisticated and powerful time-based noise reduction technology by monitoring the noise for the several video frames and defining and eliminating them consecutively at low light. Higher setting reduces noise much more but results in losing the sharpness and the tail effect or the motion blur for the fast moving target at low light.

Operating Instructions

5. DAY / NIGHT

DAY/NIGHT is used to control the setting during day-time and night-time operation.

Select the mode according to the light condition and the camera types.

SMART IR can be set to reduce the saturation by the strong IR illumination in the night in any menu. Setting SMART IR in any menu is identically applied to other menu. Zero(0) turns off SMART IR and High setting avoids the saturation strongly but the corners will be darker accordingly. IR LED Control(AUTO/OFF) is available with IR LED model only. If IR LED is set to OFF, IR LED will be turned OFF but DAY or NIGHT is still determined by the built-in light photo sensor.

5-1. EXT

: DAY or NIGHT is determined by the built-in light photo sensor.

Camera with IR LED must be set to EXT.

5-2. AUTO

: Used when DAY or NIGHT is determined by light level through the lens and DAY from/to NIGHT is switched automatically by the scene brightness.

D↔N THRESHOLD, D↔N DELY and SMART IR can be set in the menu.

When EXPOSURE>AGC is less than 10, DAY/NIGHT AUTO is disabled and forcibly switches to ___(DAY) to avoid the malfunction. EXT, B/W (NIGHT) and COLOR(DAY) is independent on AGC level. When EXTERNAL IR LED is used with NON IR LED model, please set to IR LED MODE ON.

DAY/NIGHT AUTO	
▷ D↔N THRESHOLD	: : : : : : 10
D↔N GAP	: : : : : : 10
D↔N DELAY	5s
SMART IR	: : : : : : 10
RETURN	RET ↵

- D↔N THRESHOLD (0~20):
Sets the threshold level switching from/to DAY(color) or NIGHT(B/W). Setting low level makes camera entered NIGHT at lower light level. High level makes camera exited NIGHT at brighter light level.
- D↔N GAP (0~15):
Sets the gap level switching from/to DAY(color) or NIGHT(B/W).

Operating Instructions

- **D↔N DELAY (0~60s):**
Sets the delay time when the camera switches from/to DAY(color) or NIGHT(B/W).
- **SMART IR :**
SMART IR can be set to reduce the saturation by the strong IR illumination in the night in any menu of EXT, AUTO and B/W(NIGHT). Setting SMART IR in any menu is identically applied to other menu. Zero(0) turns off SMART IR and high level avoids the saturation strongly but the corners will be darker accordingly.

5-3. B/W(NIGHT)

: Forcibly removes IR cut filter and switches to B/W regardless of light level.

5-4. COLOR(DAY)

: Forcibly DAY/NIGHT is disabled and outputs color video.

5-5. COLOR D/N

: Forcibly Color mode, optimized for night condition. It is available to recognize colors of car, people and moving objects even at night. Parameters can be controllable & programmable according to circumstance. Application for bright circumstance at night such as downtown, civic area, street, mall and etc.

Conventional COLOR mode in NIGHT



COLOR D/N mode in NIGHT



6. PICT ADJUST

PICT ADJUST

▷	WHITE BAL	ATW
	SHARPNESS	: : : : : : 10
	COLOR GAIN	: : : : : : 10
	GAMMA DAY	0.50
	SHADING	AUTO
	RETURN	RET ↵

Operating Instructions

6-1. WHITE BAL (default: ATW)

: ATW, ATWext, ONE PUSH and MANUAL are available for the white balance modes.

- ATW: White balance is continuously working along with the color temperature changes in the range of 2,000K~8,500K.
- ATWext: White balance is continuously working along with the color temperature changes in the range of 1,800K~11,000K.
- ONE PUSH: White balance works only during ● is pressed.
- MANUAL: White balance is fixed to the settings by R_GAIN and B-GAIN. This mode can be used only when the color temperature does not vary.

6-2. SHARPNESS (default: 10) : Adjusts the sharpness of video.

6-3. COLOR GAIN (default: 10): Adjusts the color level of video.

6-4. GAMMA DAY (default: 0.5): Adjusts the gamma of day time video.

6-5. SHADING (default: AUTO) : Select ON/OFF or AUTO for compensation of video image.

7. SPECIAL

SPECIAL	
▷ MIRROR/FLIP	OFF
PRIVACY	OFF
MOTION	OFF
PIXEL DEFECT	OFF
TITLE SET	↓
DISPLAY	↓
DEFOG	OFF
POINTING ZOOM	OFF
PRESET ZOOM	OFF
RETURN	RET ↓

7-1. MIRROR/FLIP (default: OFF)

: Reverses the video left and right and/or up and down by MIRROR/FLIP.

- OFF : Normal display without mirroring or flipping
- Hor. : Video is reversed left and right
- Ver. : Video is reversed upside down.
- HV : Video is reversed left and right and upside down. When the video is reversed by Ver. or HV, then the joystick directions are reversed accordingly. This feature is very useful when a camera is installed in upside down.

Operating Instructions

7-2. PRIVACY

- : 10 Privacy zones which can be enabled individually by ZON DISP are available to mask the video.
- ZONE NUM : Set a number to select a privacy zone from 1~10.
- ZONE DISP : ON enables to display relevant privacy zone
- H-POS, V-POS, H-SIZE and V-SIZE : Adjust the size and position of zone.
- COLOR : Select the color used for masking the zone form eight colors.
- TRANSPARENCY : Defines the transparency for the mask zone.

7-3. MOTION (default: OFF)

: MOTION can detect the changes in the motion window and displays the results in blocks and/or a text message.

MOTION	
▷ SENSITIVITY	: : : : : : : : 10
H-POS	10
V-POS	5
H-SIZE	40
V-SIZE	25
BLOCK DISP	OFF
MOTION OSD	OFF
SMART MOTION ZOOM	OFF
STAY ZOOMING	5sec
RETURN	RET ↵

- SENSITIVITY : Adjusts the detection sensitivity for motion.
High value increases the sensitivity to detect the small motion easily. Too low sensitivity will cause the erratic detection by the tree leaves or the light level changes.
- H-POS, V-POS, H-SIZE and V-SIZE -
Adjust the size and position of the detection window.
- BLOCK DISP : ON enables to display the blocks for the detected area.
- MOTION OSD : ON enables to display a text message, MOVING !!!,
- SMART MOTION ZOOM : ON enables to Automatic Zoom IN/OUT when motion is detected and also enables MOTION OSD to ON.
Area to be zoomed in by SMART MOTION ZOOM can be set at SPECIAL> MOTION> SMART MOTION ZOOM>ZOOM TARGET. Adjusting ◀, ▶ (Joystick) for ZOOM TARGET varies the viewing angle to be zoomed when the motion occurs. Set the video left and right and/or up and down by MIRROR/FLIP.
(See page No.28 "SMART MOTION ZOOM")

Operating Instructions

- ※ SMART MOTION ZOOM doesn't work at low light condition and BW.
- STAY ZOOMING : Sets the duration time for zooming by Motion.



NOTICE

: SMART MOTION ZOOM does not work at low sensitivity and B/W mode.



CAUTION

- Set the direction of video by MIRROR/FLIP before SMART MOTION ZOOM setting. Otherwise ZOOM TARGET could be different from your intention.





7-4. PIXEL DEFECT (default: OFF)









: Detects and compensates the white pixels which become defective.

Once CALIBRATE is selected, the pixel calibration is initiated with lens closed and can't cancel.

- THRESHOLD : Defines the level of detection and low value detects more pixels. Be sure to set the value so that the pixels are uniformly blinking over the entire screen. Too low value will get the bad results because too many pixels are detected as the bad pixels and the maximum number of pixels for compensation will be filled by the upper area.
- EXECUTE '  ' : Long pressing will execute the pixel calibration for the detected pixels. Menu will exit automatically after compensation.

7-5. TITLE SET

: Camera title(name) can be set and edited up to 15 alpha numeric and symbolic characters from ASCII codes(ENGLISH only). , , ,  moves the cursor to next input. Choose a character and '  ' selects it. The selected characters are added and displayed on the top left Corner and the cursor moves right automatically for next input.

- SP - Space is inserted when pressed '  '
- BS – Cursor moves back when pressed '  '
- CLR – Clears all the characters on input line when pressed '  '.
- POS – To be able to set the title position by , , ,  and .

7-6. DISPLAY

: Enables or disables to display the OSD.

- ID : ON enables to display the camera ID defined by SYSTEM>COMM. SETUP>CAM ID.
- TITLE : ON enables to display the camera title(name) set by SPECIAL>TITLE SET.

Operating Instructions

- **ZOOM RATIO** : ON enables to display the zoom ratio on the bottom right corner. OZx.x appears during the optical zoom and DZx.x will display by multiplying the optical zoom ratio and the actual digital zoom ratio.
- **FOCUS INDICATE** : * mark on the bottom right corner indicates the focusing status in blue during focusing and white after finishing.

7-7. DEFOG (default: OFF)

- **AUTO** : Enhance the foggy video automatically according to status of scene.
- **MANUAL** : Sets to enhance the foggy video manually regardless of status of scene.
- **LEVEL** : LOW, MID, HIGH
Video quality can be less in normal environments.

7-8. POINTING ZOOM

ON enables to set off-centered location to be the center of zoom H-POINTER, V-POINTER- Able to set the location of zoom center D-Zoom is available to ~ 32x. (See page No.29 "POINTING ZOOM")

CAUTION

- Set the direction of video by MIRROR/FLIP before POINTING ZOOM setting. Otherwise location of zoom center could be different from your intention.

7-9. PRESET ZOOM

Able to zoom in for the preset area by PTZ controller.

PRESET ZOOM	
▷ ZONE NUM	1
ZONE VIEW	ON ↙
H-POS	5
V-POS	5
O-ZOOM RATIO	OX2.0
D-ZOOM RATIO	DX2.0
STAYING ZOOMING	3sec
RETURN	RET ↙
By Remote Controller only.	

- **ZONE NUM** : Set a number to select a preset zoom from 1~ 4.
- **ZONE VIEW** : ON enables a relevant preset zone.
- **H-POS** and **V-POS** : Adjust the size and position of preset zone.

Operating Instructions

- O-ZOOM RATIO: Set the Optical Zoom Ratio from OX 1.1~OX3.0
- D-ZOOM RATIO: Set the Digital Zoom Ratio from DX 1.1~DX5.0
- STAYING ZOOMING : Sets the duration time for preset zoom area.

8. SYSTEM

SYSTEM	
D	TV SYSTEM EU(PAL)
	RESOLUTION 1080P
	COMM. SETUP ↓
	LANGUAGE ENG ↵
	FACTORY DEFAULT NO
	RETUTN RET ↓

8-1. TV SYSTEM (default: US or EU)

: Selects HDTV standards for US (60HZ) or EU(50HZ). By this selection, 2nd analog video output switches to NTSC or PAL accordingly.

8-2. RESOLUTION (default: 1080P)

: Three resolutions, 1080P/720P(SCALED)/720P(CROPPED) are available. 1080P outputs 1920x1080 video at the frame rate of 30P/25P. 720P(SCALED) Image is scaled down from 1080P and outputs 1280x720 video without loss of field of view at the frame rate of 30P/25P. 720P(CROPPED) image is cropped at the center area from the image sensor and outputs 1280x720 video at the frame rate at 60P/50P but the image refresh rate is 30P/25P. Cropped image has narrowed field of view

8-3. COMM. SET UP

: COMM. SETUP defines the CAM ID, BAUD RATE and PROTOCOL. Data length, stop bit and parity are fixed to 8bit, 1stop bit and no parity bit.

- CAM ID – Assigns the camera ID from 1~255 for the comm. address.
- BAUD RATE – Selects the baud rate from 2400~115200.
- PROTOCOL – Selects the comm. Protocol from PELCO-D/P or VISCA.

(Refer to 'TIP' for setting RS-485 communication with PTZ Controller)

8-4. LANGUAGE (default: ENG)

: 8 languages are available for ENGLISH, TURKISH, GERMAN, FRENCH, ITALIAN, SPANISH, POLISH and JAPANESE.

When changing LANGUAGE, select the prefer language.

8-5. FACTORY DEFAULT (default: NO)

: RECALL ↵ roads and saves the factory defaults.

Operating Instructions

Detail Function Description

SMART MOTION ZOOM

SMART MOTION ZOOM enlarges the certain area defined by a yellow window to the full sized image when the motion is detected in the black window.

SMART MOTION ZOOM window can be re-sized by adjusting D-ZOOM RATIO and moved by H-POS and V-POS

UNLIKE the conventional zoom which can zoom in/out the center area of image only, by the flexible zoom location and area, SMART MOTION ZOOM differentiates its usefulness from others.

That is, a conventional camera installed on the corner of ceiling can zoom the center of the floor in a room and result in losing the image of door on the side wall. However, SMART MOTION ZOOM can be set to see the door side and zoom in that area without missing the IMPORTANT security point.

SMART MOTION ZOOM	
▷ ZONE VIEW	OFF
H-POS	10
V-POS	10
O-ZOOM RATIO	OX2.0
D-ZOOM RATIO	DX2.0
MOTION CHK CUNT	3
RETURN	RET ↓

- H-POS (10) - Moves MOTION ZOOM area(Yellow window) horizontally
- V-POS (10) - Moves MOTION ZOOM area(Yellow window) vertically
- O-ZOOM RATIO (OX2.0) - Sets the area size to be Optical zoomed when the motion occurs in the black window
- D-ZOOM RATIO (DX2.0) - Sets the area size to be Digital zoomed when the motion occurs in the black window
- MOTION CHK COUNT (3) - SMART MOTION ZOOM is activated after the motions in MOTION CHK COUNT are detected in a certain period.

For example, '1' immediately initiates SMART MOTION ZOOM by the motion detected once. High count number enables SMART MOTION ZOOM with sureness but with delay and less sensitivity.

Operating Instructions

POINTING ZOOM

This camera has a very useful and powerful feature, POINTING ZOOM, which can zoom in/out any area.

UNLIKE the conventional zoom which can zoom in/out the center area of image only, by the flexible zoom location and area, POINTING ZOOM differentiates its usefulness from others. That is, a conventional camera installed on the corner of ceiling can zoom the center of the floor in a room and result in losing the image of door on the side wall.

However, POINTING ZOOM can be set to see the door side and zoom in that area without missing the IMPORTANT security point.

POINTING ZOOM can be activated by the joystick operations of ▲ for zoom in and ▼ for zoom out or via web viewer, while SMART MOTION ZOOM is activated by the result of motion detection in the defined area.

If Zoom ratio becomes out of optical zoom ratio, it automatically turns to Digital Zoom.

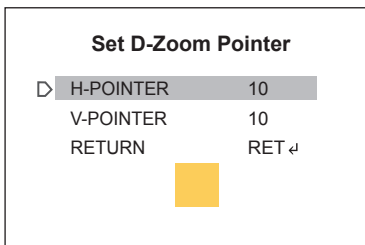





- H-POINTER (10):
Sets the horizontal location of area to be zoomed by POINTING ZOOM.
- V-POINTER (10):
Sets the vertical location of area to be zoomed by POINTING ZOOM.

Operating Instructions

* EXAMPLE OF SMART MOTION & POINTING ZOOM

 <p>Just center of picture can be zoomed in.</p>	 <p>We never miss off-centered area.</p>
 <p>Hey!! what's going on???</p>	 <p>We're always with you.</p>

[At the ATM nearby ENTERANCE]

 <p>Just center of picture can be zoomed in.</p>	 <p>Beyond zoom targeting limitation</p>
 <p>Do you really want to check the floor?</p>	 <p>Only available with high-end Technology.</p>

[At the LOBBY]

Specifications

ITEM	HDD-2080Z03IR D
Imaging Sensor	Panasonic 1/3" Progressive Scan CMOS Sensor
Effective Pixels	1,944(H) x 1,092(V)
Min.Illumination	0.0008 Lux @ (AGC MAX, DSS x2)
Video Resolution	1920x1080(30p/25p)
TV System	EU(PAL)
Sync. System	Internal
Format	16:9 Video format for most popular commercial HDTV monitors
Selectable Video Output	EX-SDI: 270Mbps Visually lossless compression thru 75Ω BNC conn. HD-SDI: 1.485 Gbps, (SMPTE 292M) thru 75Ω BNC conn.
Video Sub-out	NTSC/PAL standard, 1Vp-p @75Ω composite
HD Trans. Distance	EX-SDI: 350m+ (RG59, 5C2V) HD-SDI: 80~140m(RG59, 5C2V), 230m(Belden 1694A)
S/N Ratio	More than 50dB (AGC OFF)
Lens	f=3~9mm F1.2~F2.1, D/N zoom lens (Optical 3x, Digital 32x)
LEDs	Built-in 2pcs x 850nm High power IR-LEDs
Day & Night	TDN by dual filter switcher, EXT, AUTO, B/W, COLOR, COLOR D/N
Focus	Auto / Zoom Push / Manual
Min. Focus Distance	0.5m~
White Balance	ATW / ATWext / One Push / Manual
WDR	True WDR by dual scan images in two frames at 30fps
Special Features	SMART MOTION ZOOM, POINTING ZOOM, PRESET ZOOM
Functions	NORMAL, WDR, D-WDR, 3DNR, SMART IR, Motion Detection, BLC/HLC, Privacy Mask, D-Zoom, Sens-up(x32), Defog, DSS, Pixel Defect Compensation, Title Set, Motion Deblur, Lens Refresh, Lens Initialize, Home Position
Remote Control	RS-485(Pelco-D/P)
Languages	English, German, French, Italian, Spanish, Polish, Japanese, Turkish
Installation Temp.	-20°C ~ +50°C (Humidity : 20%RH ~ 80%RH)
Operating Temp.	-30°C ~ +50°C (Humidity : 20%RH ~ 80%RH)

Specifications

External Dimension	140mm(W) x119mm(H), Ø100-bubble / About 1kg
Mechanical Feature	IP67 / IK10, Aluminum Cast, Cooling Fan & Heating function, Flush mount, 3-Axis gimbal, Anti-Scratch Hard coated clear Bubble
Power Source	AC24V~8VA/DC12V=500mA, 6W Circuit protection against faulty connection in power polarity. Isolated power supply against ground loop problem.

(*) Design and specifications are subject to change for product improvements without prior notice.



eneo® is a registered trademark of
Videor E. Hartig GmbH
Exclusive distribution through special-
ised trade channels only.

Videor E. Hartig GmbH
Carl-Zeiss-Straße 8
63322 Rödermark/Germany
Tel. +49 (0) 6074 / 888-0
Fax +49 (0) 6074 / 888-100
www.videor.com
www.eneo-security.com

Technical changes reserved

© Copyright by Videor E. Hartig GmbH
Version 03/2015