

FOR A GOOD **REASON** **GRUNDIG**

en

Owner's Manual

IP Cameras

GCI-K2795P

2 MP Full HD Outdoor Motorized Dome IP-Camera 30x Zoom
ICR WDR

GCI-K2795P.146.1.17.07.2014
© ASP AG



| | | | |
|---|----|---|----|
| Content: | | 17. View Information | 58 |
| 1. Introduction | 1 | 18. Factory Default | 61 |
| 2. Important Safety Instructions | 2 | 19. Software Version | 62 |
| 3. Package Contents | 2 | 20. Software Upgrade | 63 |
| 4. Installation | 3 | 21. Maintenance | 64 |
| 1. Preparation for Dome Camera Setup | 3 | 10. Streaming Settings | 65 |
| 2. Switch & Connector Definition | 4 | 1. Video Format | 65 |
| 3. System Requirements | 4 | 2. Video Compression | 67 |
| 4. Cable Connection | 4 | 3. Video OCX Protocol | 68 |
| 5. Alarm Connection | 5 | 4. Video Frame Rate | 69 |
| 6. Audio Connection | 5 | 5. Audio (Audio and Bit Rate Settings) | 70 |
| 5. Accessing the Camera | 6 | 11. PTZ Settings | 71 |
| 6. Video Resolution Setup | 10 | 1. Preset | 71 |
| 7. Browser-based Viewer Introduction | 13 | 2. Cruise | 72 |
| 8. Home Page | 14 | 3. Auto Pan | 73 |
| 9. System Related Settings | 18 | 4. Sequence | 74 |
| 1. Host Name & System Time Setting | 18 | 5. Home | 75 |
| 2. Security | 19 | 6. Tilt Range | 76 |
| 3. Network | 28 | 7. Privacy Mask | 77 |
| 4. DDNS | 34 | 8. Camera - Exposure | 78 |
| 5. Mail | 35 | 9. Camera - WB | 79 |
| 6. FTP | 36 | 10. Camera - Misc 1 | 80 |
| 7. HTTP | 37 | 11. Camera - Misc 2 | 81 |
| 8. Application (Alarm Settings) | 37 | 12. Camera - Default | 82 |
| 9. Motion Detection | 43 | 12. Logout | 83 |
| 10. Network Failure Detection | 47 | 13. CMS Software Introduction | 83 |
| 11. Periodical Event | 48 | 14. Internet Security Settings | 84 |
| 12. Autotracking | 49 | 15. GRUNDIG Viewer Download Procedure | 87 |
| 13. Storage Management (on Camera) | 52 | 16. Install UPnP Components | 89 |
| 14. Recording (on Camera) | 55 | 17. Deleting the Existing GRUNDIG Viewer | 91 |
| 15. Schedule | 55 | | |
| 16. File Location (on PC) | 57 | | |

1. Introduction

The Full HD Motordome IP Camera GCI-K2795P transmit digital Full HD video and audio data using a network connection. The live video can be monitored and recorded on a windows-based computer via the network.

The Motordome Camera supports a real-time Main Profile H.264 Full HD resolution. Simultaneous dual streams, H.264/H.264 and H.264/MJPEG, are available for various network applications via speeding or limited bandwidth. Better image quality and high resolution are delivered by the progressive scan. This eliminates the “combing” effect due to scene change and produces a more stabilised image.

With this IP solution, multiple authorised users can view the immediate image from any location through the network even when using a standard web-browser. This enables users to access the camera without being at a specific location.

2. Important Safety Instructions

Be sure to use only the standard adapter that is specified in the specification sheet. Using any other adapter could cause fire, electrical shock, or damage to the product. Incorrectly connecting the power supply may cause explosion, fire, electric shock, or damage to the product. Do not connect multiple products to one single adapter. Exceeding the capacity may cause abnormal heat generation or fire.

Do not place conductive objects (e.g. screwdrivers, coins or any metal items) or containers filled with water on top of the product. Doing so may cause personal injury due to fire, electric shock, or falling objects.

If any unusual smells or smoke comes out of the unit, stop using the product. In this case, immediately disconnect the power source and contact the service center. Continued use in such a condition may cause fire or electric shock.

If this product fails to operate normally, contact the nearest service center. Never disassemble or modify this product in any way. (GRUNDIG is not liable for problems caused by unauthorised modifications or attempted repair.)

To prevent fire or electric shock, do not expose the inside of this device to rain or moisture.

If the PTZ system loses its power supply during freezing temperatures and the power supply returns afterwards, the Motordome Camera will first heat up internally to +3° C and then the initialisation will start. In this way, it can be prevented that the sliding contacts and the motors get damaged through a cold start.

3. Package Contents

These parts are included:

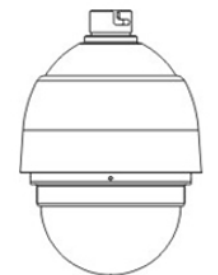

Camera with
Outdoor Mount Kit



M3 Standard Screw (x1)
M3 Security Screw (x1)
M5 Standard Screw (x1)
M5 Security Screw (x1)



Waterproof
Rubber



Lubricant

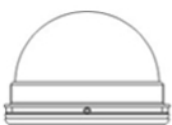

Optical Cover



Security Torx

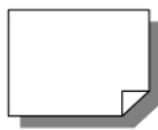

Quick Guide



CD
(Manuals and Software)

4. Installation

Do not install the product in a location subject to high temperature (over 50°C), low temperature (below -10°C), or high humidity. Doing so may cause fire or electric shock. Keep out of direct sunlight and heat radiation sources. This may cause fire. Avoid aiming the camera directly towards extremely bright objects such as the sun, as this may damage the image sensor.

Do not install the unit in humid, dusty or sooty locations. Doing so may cause fire or electric shock. Install it in a place with good ventilation.

When installing the unit, fasten it securely and firmly. A falling unit may cause personal injury.

If you want to relocate the already installed product, be sure to turn the power off and then move or reinstall it.

4.1. Preparation for Dome Camera Setup

Please note that there will be a PE covering and PE cloth sheets on the dome cover. Furthermore, there will be a protective covering on the camera and PE cloth sheets on the camera body and a lens cap on the lens for shipping protection. Follow the steps below to remove those protective materials.

Step 1: Unpack the dome package and take out the dome body.

Step 2: Rotate and remove the protective cover and the PE cloth sheets from the camera body and take off the lens cap.

Step 3: Remove the PE covering and the cloth sheets from the dome cover.

Step 4: Attach the dome cover to the dome body.

4.2. Switch & Connector Definition

There are various switches and connectors located on the Dome Camera's back plate as shown in the pictures below. Please refer to the diagrams and the tables for use of each switch/connector.

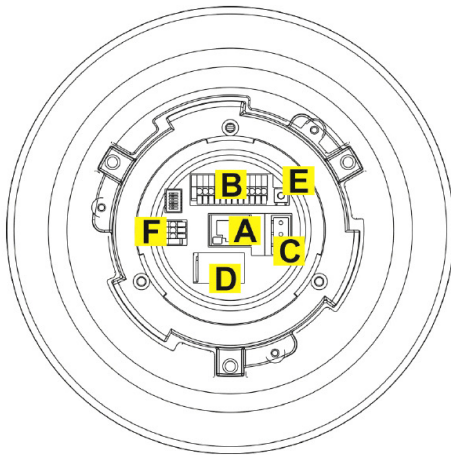

| | |
|---|----------------------|
| A | RJ45 Connector |
| B | ALARM I/O |
| C | Power |
| D | Micro SD Card Slot |
| E | Factory Reset Button |
| F | Audio I/O |

NOTE: DO NOT change the Motordome Camera's Communication Switch factory default settings.

4.3. System Requirements

To perform the IP Camera via web browser, please ensure your PC is in good network connection, and meets the system requirements as described below.

Personal Computer :

- 1.) Intel Pentium M, 2.16 GHz or Intel Core 2 Duo, 2.0 GHz
- 2.) 2 GB RAM or more

Operating System :

Windows XP / Windows VISTA / Windows 7

Web Browser :

Microsoft Internet Explorer 6.0 or later

Firefox

Chrome

Safari

Network Card :

10Base-T (10 Mbps) or 100Base-TX (100 Mbps) operation

Viewer :

ActiveX control plug-in for Microsoft IE

4.4. Cable Connection

For operation, the Motordome IP Camera requires a power cable and a cable with a RJ-45 connector as described below.

Please refer to the table below to set up the power connection of the camera.

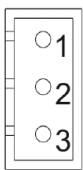

| Pin | Definition |
|-----|------------|
| 1 | AC 24_1 |
| 2 | FG |
| 3 | AC 24_2 |

Ethernet Cable Connection:

Use of Category 5 Ethernet cable is recommended for network connection; to have best transmission quality, cable length shall not exceed 100 meters. Connect one end of the Ethernet cable to the RJ45 connector of the IP Camera, and the other end of the cable to the network switch or PC.

NOTE: In some cases, you may need use an Ethernet crossover cable when connecting the IP Camera directly to the PC.

Check the status of the link indicator and the activity indicator LEDs. If the LEDs are unlit, please check the LAN connection.

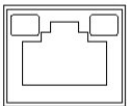

Green Link Light indicates good network connection.

Orange Activity Light flashes for network activity indication.

4.5. Alarm Connection

The Motordome Camera supports 4 digital alarm inputs and 2 digital alarm outputs. Please make sure the alarm connections are properly wired before you start to configure the alarm related settings on the "Application" menu page. Please refer to the pin definition table below for alarm system wiring.

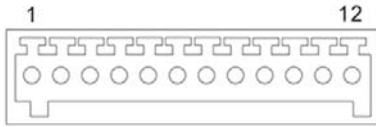

| Pin | Definition |
|-----|-----------------|
| 1 | ALARM_OUT_NC_1 |
| 2 | ALARM_OUT_NO_1 |
| 3 | ALARM_OUT_COM_1 |
| 4 | GND |
| 5 | ALARM_OUT_NC_2 |
| 6 | ALARM_OUT_NO_2 |

| Pin | Definition |
|-----|-----------------|
| 7 | ALARM_OUT_COM_2 |
| 8 | GND |
| 9 | ALARM_IN_1 |
| 10 | ALARM_IN_2 |
| 11 | ALARM_IN_3 |
| 12 | ALARM_IN_4 |

NOTE: This pin definition table indicates the status of the alarm I/O after the camera is powered up.

4.6. Audio Connection

Please refer to the table below to set up the audio connection according to the Audio pin definition.

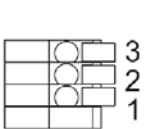

| Pin | Definition |
|-----|------------|
| 1 | LINE_OUT |
| 2 | GND |
| 3 | LINE_IN |

5. Accessing the Camera

For initial access to the IP Camera, users can search the camera through the installer program: GRUNDIG Finder.exe, which can be found on the supplied CD.

GRUNDIG Finder Software Setup :

Step 1: Double-click on the program GRUNDIG Finder.exe (see the desktop icon below). Its window will appear as shown below. Then click on the "Find Device" button.

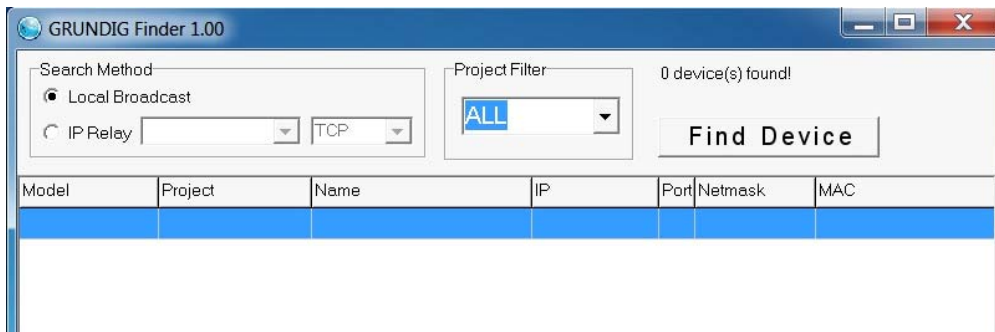

Step 2: The security alert window will pop up. Click "Unblock" to continue.



Device Search :

Step 3: Click "Find Device" again, afterwards all IP devices found will be listed on the page, as shown in the picture below. The IP Camera's default IP address is: 192.168.1.1.

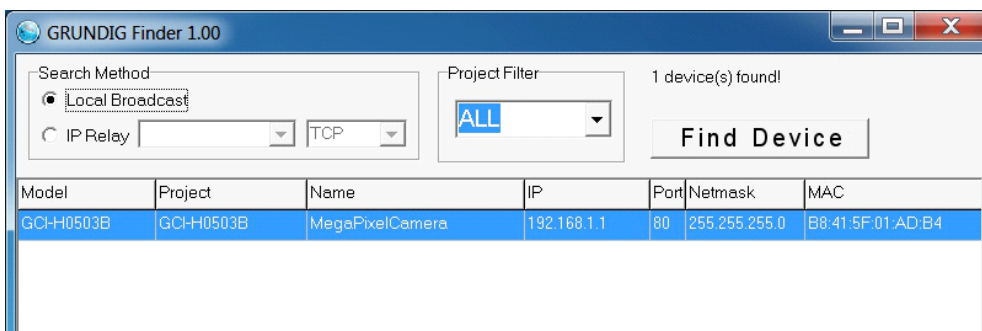

Step 4: Double-click or right-click and select "Browse" to access the camera directly via the web browser.

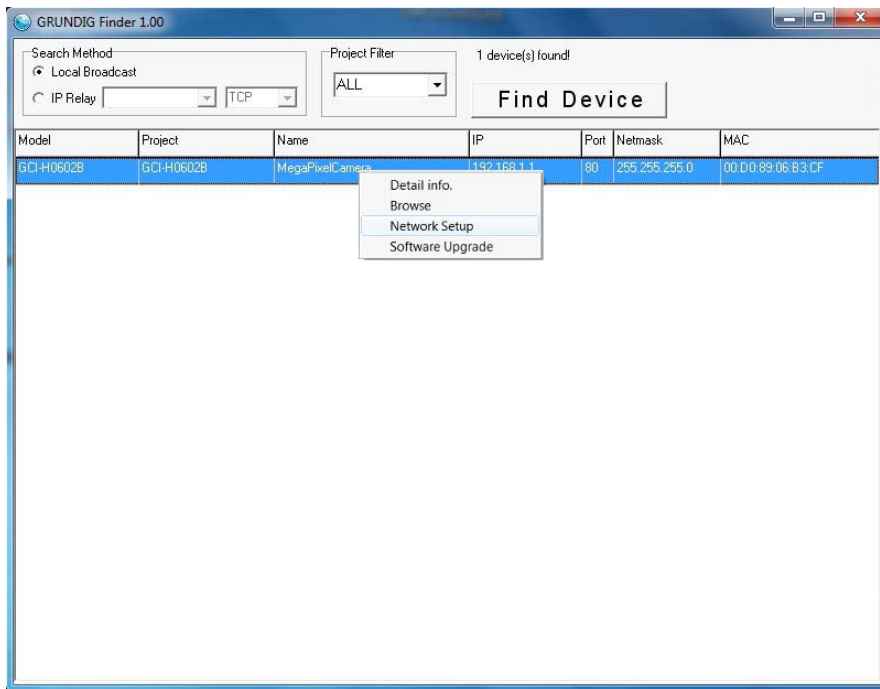

Step 5: Then the dialogue box for entering the default user name and password (as shown below) will appear for login to the IP Dome Camera.



The default login ID and password for the Administrator are:

Login ID: admin
Password: 1234

NOTE: ID and password are case sensitive.

It is strongly advised to alter the administrator's password due to security concerns. Please refer to section 9.2. Security for further details.

Additionally, users can change the IP Camera's network property, either to DHCP or Static IP, directly in the device finding list. Please refer to the following section for changing the IP Camera's network property.

Example of changing the network property of the IP Camera :

Users can directly change an IP Camera's network property, e.g. from static IP to DHCP, in the finding device list. The procedure to change the IP Camera's network property is explained below:

Step 1: In the finding device list, click on the IP Camera of which you would like to change the network property. Right-click on the selected item, and select "Network Setup". Meanwhile, record the IP Camera's MAC address for future identification.

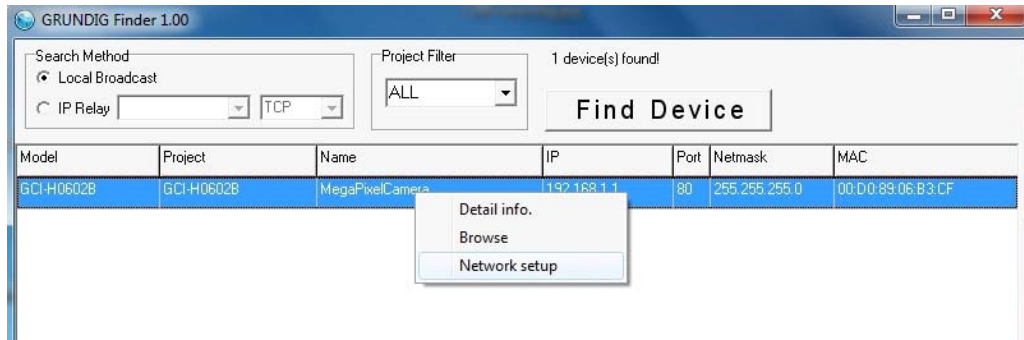

Step 2: The "Network Setup" page will come out. Select "DHCP," and click on the "Apply" button at the bottom of the page.

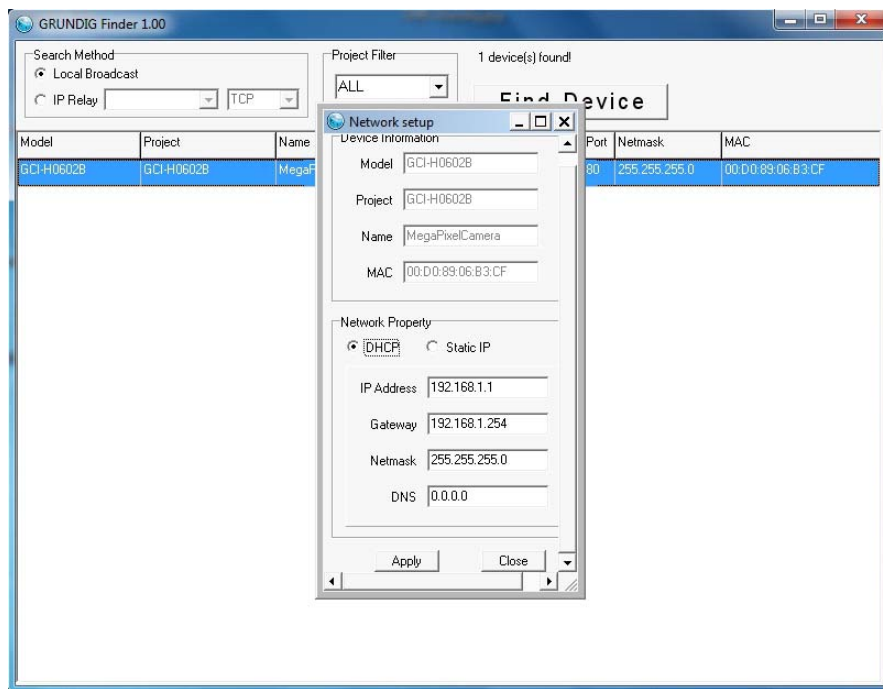

Step 3: Click on "OK" in the Note of setting the change. Wait for one minute to search again for the IP Camera.

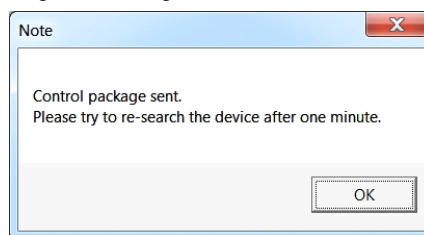

Step 4: Click on the "Find Device" button to search all the devices. Then select the IP Camera with the correct MAC address. After double-clicking on the IP Camera, the login window will appear.

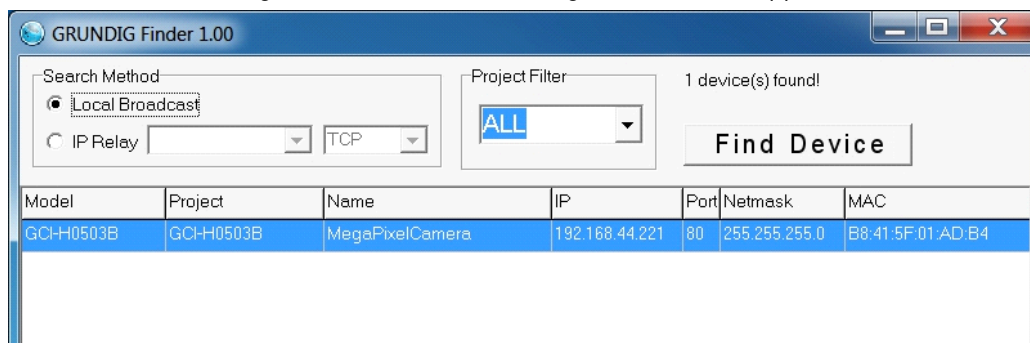

Step 5: Enter User name and Password to access the IP Camera.

Installing the GRUNDIG Viewer Software Online :

For initial access to the IP Camera, a client program, GRUNDIG Viewer, will be automatically installed to your PC when connecting to the IP Camera.

If the Web browser does not allow the GRUNDIG Viewer installation, please check the Internet security settings or ActiveX controls and plug-ins settings (see 14. Internet Security Settings) to continue the process.

The Information Bar (just below the URL bar) may come out and ask for permission to install the ActiveX Control for displaying video in browser (see the picture below). Right-click on the Information Bar and select "Install ActiveX Control..." to allow the installation.

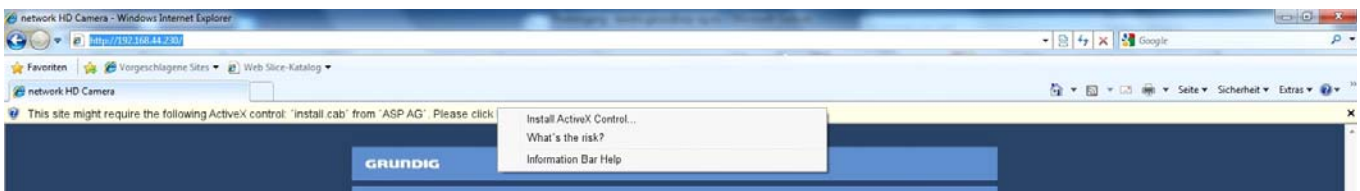

Then the security warning window will pop up. Click "Install" to carry on with the software installation.

Click on "Finish" to close the GRUNDIG Viewer window when download is finished. For detailed software download procedure, please refer to chapter 15. GRUNDIG Viewer Download Procedure.

NOTE: If the Live Video Pane on the Home Page cannot be shown to the users who have installed the GRUNDIG Viewer on the PC previously, please refer to the procedure in chapter 17. Delete the Existing GRUNDIG Viewer.

Once logged in to the IP Camera, users will see the Home page as shown below:

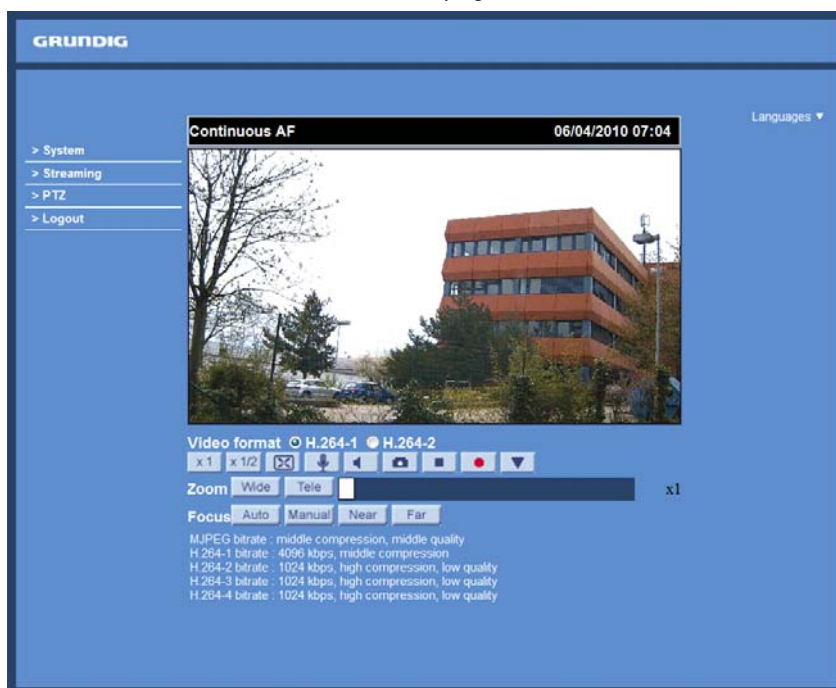

Administrator/User Privileges :

"Administrator" represents the person who can configure the IP Camera and who authorises users to have access to the camera; "User" refers to someone who has access to the camera with limited authority, i.e. to enter the Home and Camera setting pages.

Image and Focus Adjustment :

The image appears on the Home page when successfully accessing to the IP Camera. Adjust zoom and focus as necessary to produce a clear image.

6. Video Resolution Setup

The users can set up the Video Resolution on the Video Format page of the user-friendly browser-based configuration interface. The page "Video Format" can be found in the IP camera menu under the path: Streaming > Video Format.

Under the Video Resolution section in the menu page "Video Format", please select your preferred resolution setting.

| H.264 + MJPEG | |
|---------------------|---------------------|
| H.264 | MJPEG |
| 1920 x 1080 (25fps) | 720 x 576 (25fps) |
| | 640 x 480 (25fps) |
| | 352 x 288 (25fps) |
| 1920 x 1080 (13fps) | 1920 x 1080 (13fps) |
| | 1280 x 1024 (25fps) |
| | 1280 x 720 (25fps) |
| | 1024 x 768 (25fps) |
| | 800 x 600 (25fps) |
| 1280 x 1024 (25fps) | 1280 x 1024 (13fps) |
| | 1280 x 720 (25fps) |
| | 1024 x 768 (25fps) |
| | 800 x 600 (25fps) |
| | 720 x 576 (25fps) |
| | 640 x 480 (25fps) |
| | 352 x 288 (25fps) |
| 1280 x 720 (25fps) | 1280 x 720 (25fps) |
| | 1024 x 768 (25fps) |
| | 800 x 600 (25fps) |
| | 720 x 576 (25fps) |
| | 640 x 480 (25fps) |
| | 352 x 288 (25fps) |
| 1024 x 768 (25fps) | 1024 x 768 (25fps) |
| | 800 x 600 (25fps) |
| | 720 x 576 (25fps) |
| | 640 x 480 (25fps) |
| | 352 x 288 (25fps) |
| 800 x 600 (25fps) | 800 x 600 (25fps) |
| | 720 x 576 (25fps) |
| | 640 x 480 (25fps) |
| | 352 x 288 (25fps) |
| 720 x 576 (25fps) | 720 x 576 (25fps) |
| | 640 x 480 (25fps) |
| | 352 x 288 (25fps) |
| 640 x 480 (25fps) | 640 x 480 (25fps) |
| | 352 x 288 (25fps) |
| 352 x 288 (25fps) | 352 x 288 (25fps) |

| H.264 + H.264 | |
|---------------------|---------------------|
| H.264-1 | H.264-2 |
| 1920 x 1080 (25fps) | 720 x 576 (25fps)* |
| | 640 x 480 (25fps) |
| | 352 x 288 (25fps) |
| 1920 x 1080 (13fps) | 1920 x 1080 (13fps) |
| | 1280 x 1024 (25fps) |
| | 1280 x 720 (25fps) |
| | 1024 x 768 (25fps) |
| | 800 x 600 (25fps) |
| 1280 x 1024 (25fps) | 1280 x 1024 (13fps) |
| | 1280 x 720 (25fps) |
| | 1024 x 768 (25fps) |
| | 800 x 600 (25fps) |
| | 720 x 576 (25fps) |
| | 640 x 480 (25fps) |
| | 352 x 288 (25fps) |
| 1280 x 720 (25fps) | 1280 x 720 (25fps) |
| | 1024 x 768 (25fps) |
| | 800 x 600 (25fps) |
| | 720 x 576 (25fps) |
| | 640 x 480 (25fps) |
| | 352 x 288 (25fps) |
| 1024 x 768 (25fps) | 1024 x 768 (25fps) |
| | 800 x 600 (25fps) |
| | 720 x 576 (25fps) |
| | 640 x 480 (25fps) |
| | 352 x 288 (25fps) |
| 800 x 600 (25fps) | 800 x 600 (25fps) |
| | 720 x 576 (25fps) |
| | 640 x 480 (25fps) |
| | 352 x 288 (25fps) |
| 720 x 576 (25fps) | 720 x 576 (25fps) |
| | 640 x 480 (25fps) |
| | 352 x 288 (25fps) |
| 640 x 480 (25fps) | 640 x 480 (25fps) |
| | 352 x 288 (25fps) |
| 352 x 288 (25fps) | 352 x 288 (25fps) |

| MJPEG Only |
|---------------------------------|
| MJPEG |
| 1920 x 1080 (25fps) |
| 1280 x 1024 (25fps) |
| 1280 x 720 (25fps) |
| 1024 x 768 (25fps) |
| 800 x 600 (25fps) |
| 720 x 576 (25fps) |
| 640 x 480 (25fps) |
| H.264 Only |
| H.264 |
| 1920 x 1080 (25fps) Low Latency |
| 1920 x 1080 (25fps) |
| 1280 x 1024 (25fps) |
| 1280 x 720 (25fps) |
| 1024 x 768 (25fps) |
| 800 x 600 (25fps) |
| 720 x 576 (25fps) |
| 640 x 480 (25fps) |
| 352 x 288 (25fps) |

(*) Default

Click on "Save" to confirm the setting.

7. Browser-based Viewer Introduction

The picture below shows the Home page of the IP Camera's viewer window.

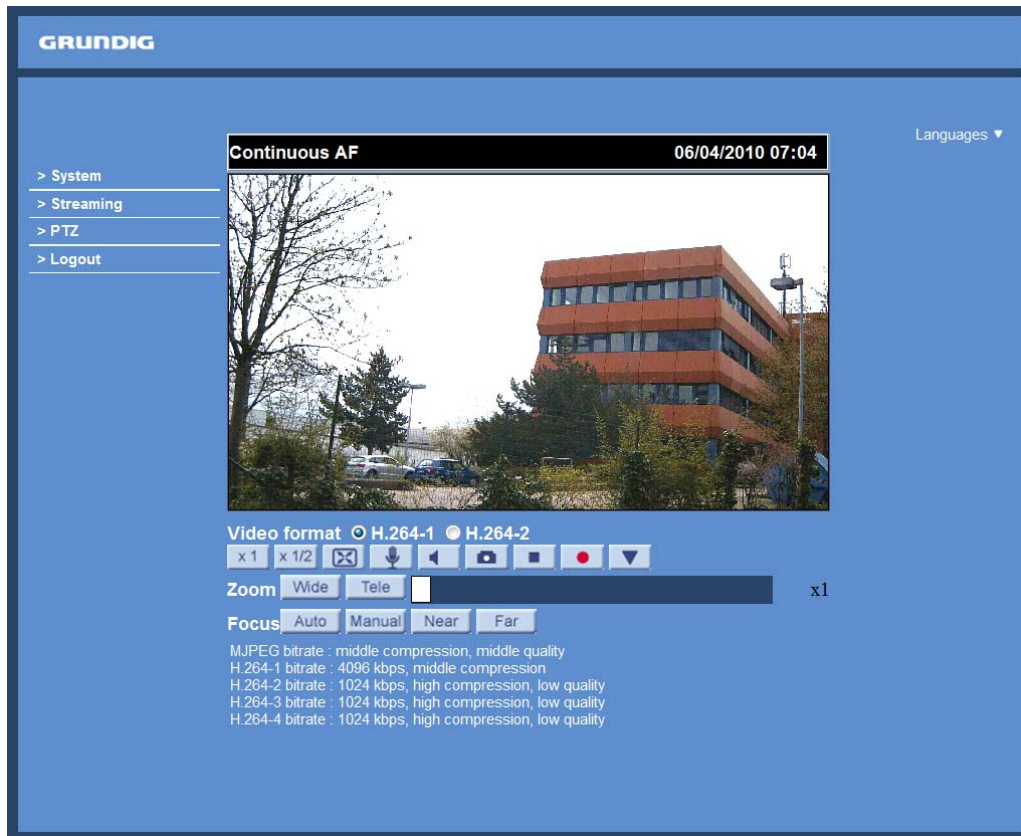

There are four tabs on the left (System, Streaming, PTZ and Logout) and one tab on the right (Languages).

System setting :

The administrator can set host name, system time, admin password, network related settings, etc. Further details will be interpreted in chapter 9. System Related Settings.

Streaming setting :

The Administrator can configure a specific video resolution, video compression mode, video protocol, audio transmission mode, etc. in this page. Further details will be interpreted in chapter 10. Streaming Settings.

PTZ setting :

Users can adjust various camera parameters including Presets, Cruises, Privacy Masks, Exposure, White Balance, Brightness, Sharpness, Contrast, Digital Zoom, etc.

Logout :

Click on the tab to re-login into the Motordome Camera with another username and password.

8. Home Page

In the Home page, there are several function buttons that are specified below.

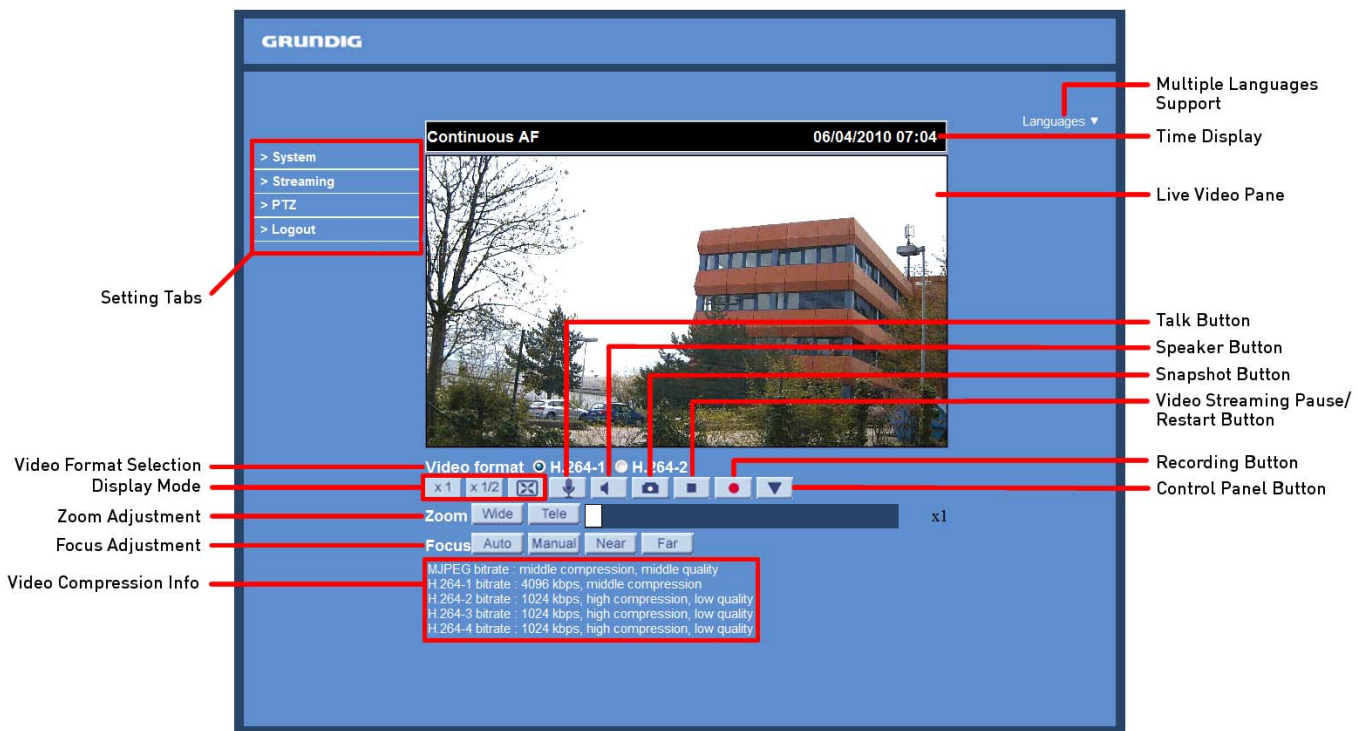

NOTE: Please note that the function buttons can vary depending on the camera model.

Display Mode (Screen Size Adjustment) :

The display size of the image can be adjusted to x1/2 and full screen.

Talk Button (on/off) :

Talk function allows the local site to talk to the remote site. Click on this button to switch it on/off. Please refer to section 9.2. Security: User >> Add user >> Talk/Listen for further details. This function is only open to the "User" who has been granted this privilege by the Administrator.

Please note that additional equipment will be necessary.

Speaker Button (on/off) :

Click on the Speaker button to mute/activate the audio.

Snapshot button :

After pressing this button, the JPEG snapshots will automatically be saved in the appointed place. The default place of saving snapshots is: C:\. For changing the storage location, please refer to section 9.16. 'File Location (on PC)' for further details.

NOTE: Users with the Windows 7 operating system on their PC need to follow the following procedure to be able to use the Snapshot function. First you need to log on to your computer as an Administrator. Then please go to Windows Start menu, click with the right mouse button on your Internet Browser and select in the appearing pop-up window "Run as Administrator". Afterwards you can log in to your camera as usual (as an administrator or user).

Video Streaming Pause/Restart Button (pause/restart) :

If you click on the stop button to disable video streaming, the live video will be displayed as black. Click on the restart button to show the live video again.

Recording button (on/off) :

When you click on this button, the recordings from the Live View will be saved to the location specified in the "File Location" page. The default storage location for the recording is: C:/ . See section 9.16. 'File Location (on PC)' for further details.

NOTE: Users with Windows 7 operating system on their PC who want to use the Recording function, need to follow the procedure in the NOTE below the "Snapshot button" section in this chapter.

Control Panel Button :

Click on the <Control Panel> button to open and close the Control Panel in the homepage.

Pan/Tilt Control :

Users can implement pan/tilt control by first moving the cursor to the live video pane; then left-click, hold the click and drag the pointer in any direction.

NOTE:

The following functions are not available for the Browsers Firefox, Chrome, Safari and Opera: Full Screen Mode, Digital Zoom in Live View, Audio talk/listen, Snapshot, Playback and Recording.

Optical/Digital Zoom Control :

In Normal View display mode, users can implement zoom in/out by clicking in the zoom setting bar and adjusting the zoom manually or by clicking on the "Wide" / "Tele" buttons. In Full Screen mode, users can rotate the mouse wheel to zoom in/out on the image. Digital zoom is only available when this function is activated and set in the "Camera-Misc1" page under the "PTZ" tab; see section 11.10. Camera—Miscellaneous Setups 1 for details. When the camera reaches the limit of its optical range, it will automatically switch to digital zoom.

Zoom Adjustment :

Click on the buttons "Wide" / "Tele" to control zoom in/out or move the cursor onto the zoom adjustment bar and click on the desired position to change the room ratio.

Focus Adjustment :

- Auto Focus (Continuous AF):

Click on the "Auto" button to enable AF mode. In this mode, the camera will keep in focus automatically and continuously regardless of zoom changes or any other view changes. The Focus status will also be displayed above the live video pane as shown below.

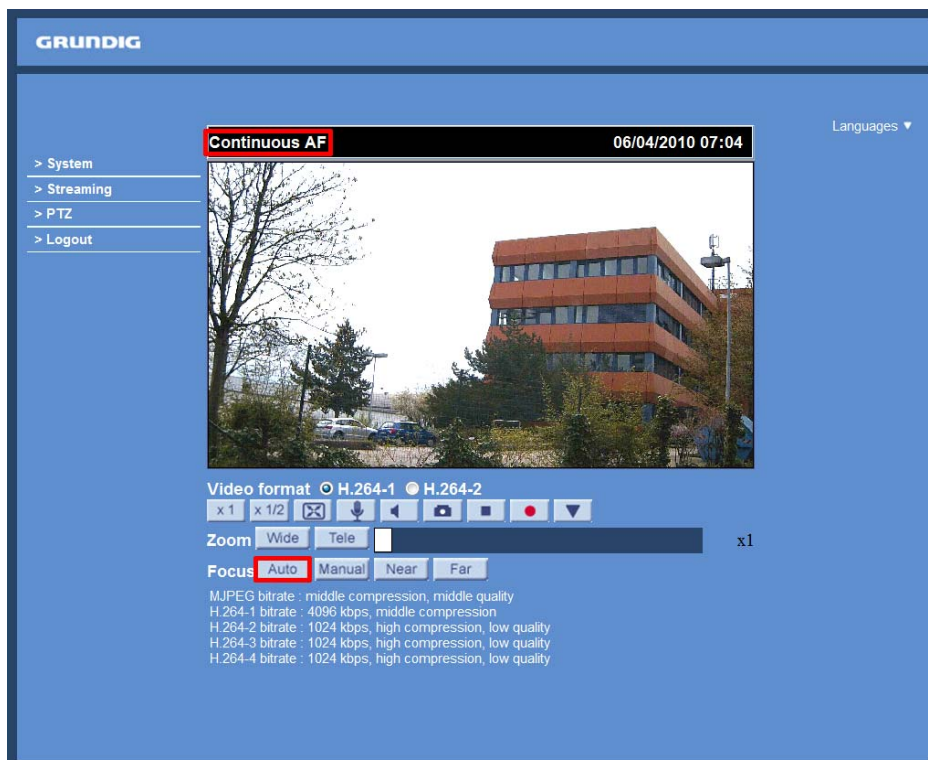

- Manual Focus:

After clicking on the “Manual” button, users can adjust the focus manually via the “Near” and “Far” buttons. The status will also be displayed above the screen as shown below.

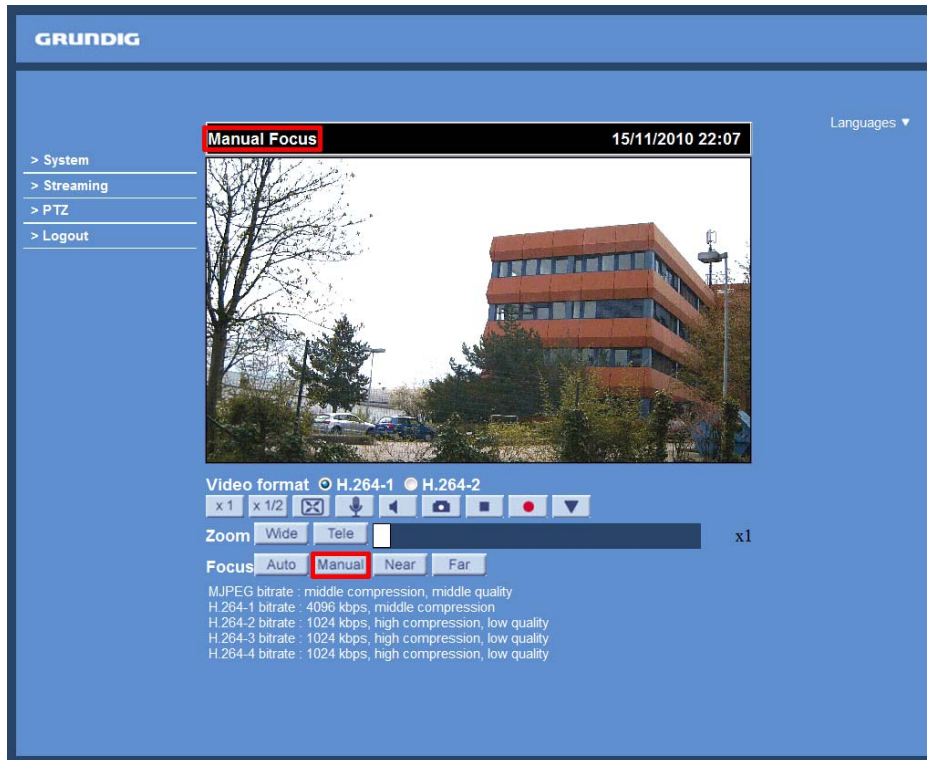

Multiple Languages Support :

Multiple languages are supported for the viewer window interface.

Furthermore, after clicking on the <Control Panel> Button, the Control Panel will be shown as in the figure below.

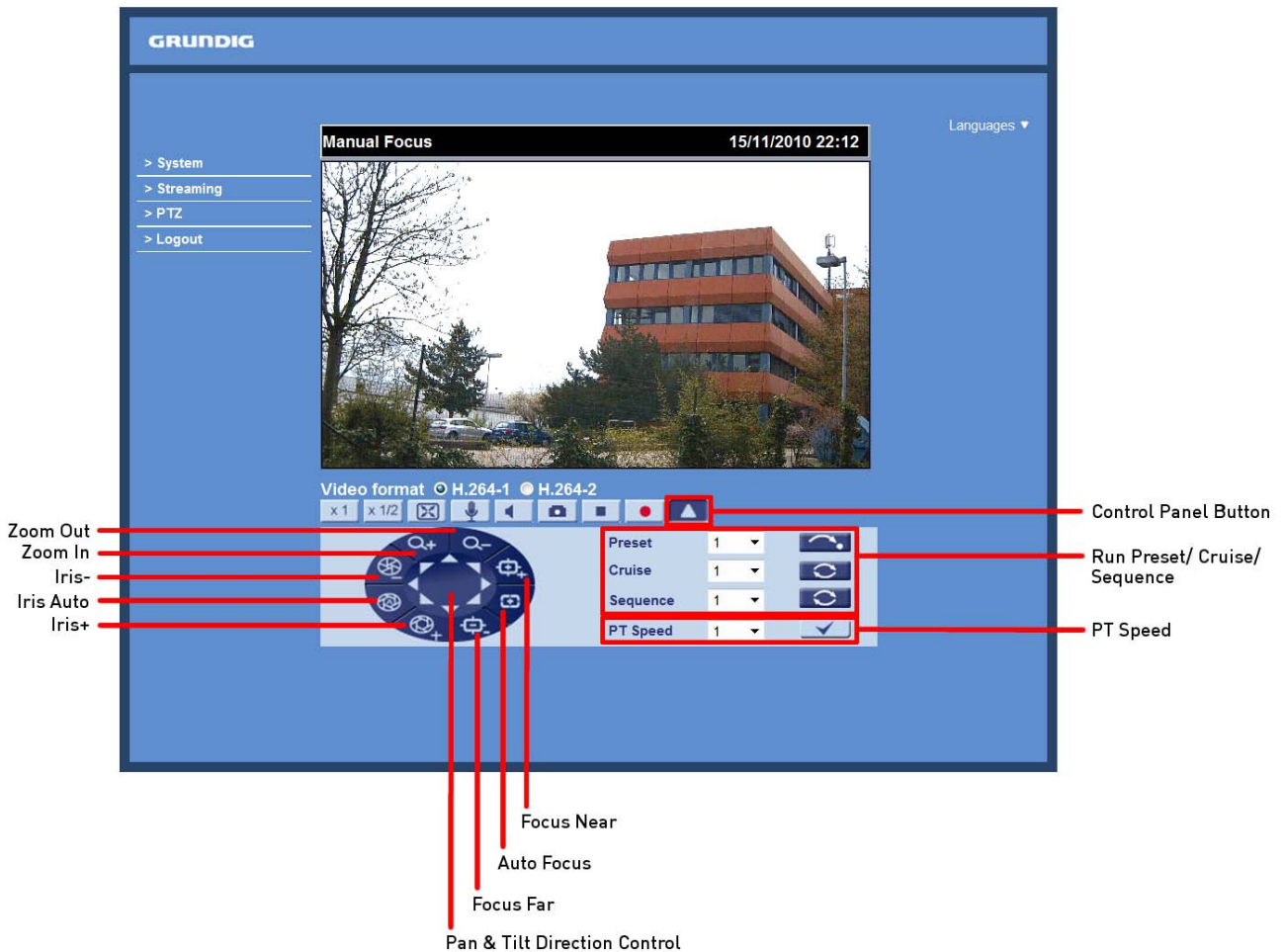

Control Panel :

- Pan & Tilt Direction Control:

The <Pan and Tilt Direction Control> on the Control Panel allows users to control the Camera with browser viewers other than IE.

- Iris Control (Auto Iris/ Iris+/ Iris-):

Click on the buttons (Auto Iris/ Iris+/ Iris-) to adjust the Iris parameters.

- Zoom (Zoom In/ Zoom Out):

Click on the buttons to zoom in or zoom out.

- Focus (Auto Focus/ Focus Near/ Focus Far):

Click on these buttons to adjust the focus near, far or automatically.

- Run Preset/ Cruise/ Sequence:

After setting up the Preset/ Cruise/ Sequence lines in the PTZ Settings, select a Preset/ Cruise/ Sequence line and start it by clicking on the according <Run> button.

- PT Speed (1~10):

Set a number between 1 and 10 as the PT Speed. With this speed the camera will move when a user pans or tilts the Camera via the Pan & Tilt Direction Control Panel. 1 is the slowest, 10 is the fastest.

9. System Related Settings

The picture below shows all categories under the “System” tab. Each category in the left column will be explained in the following sections.

NOTE: The “System” configuration page is only accessible by the Administrator.

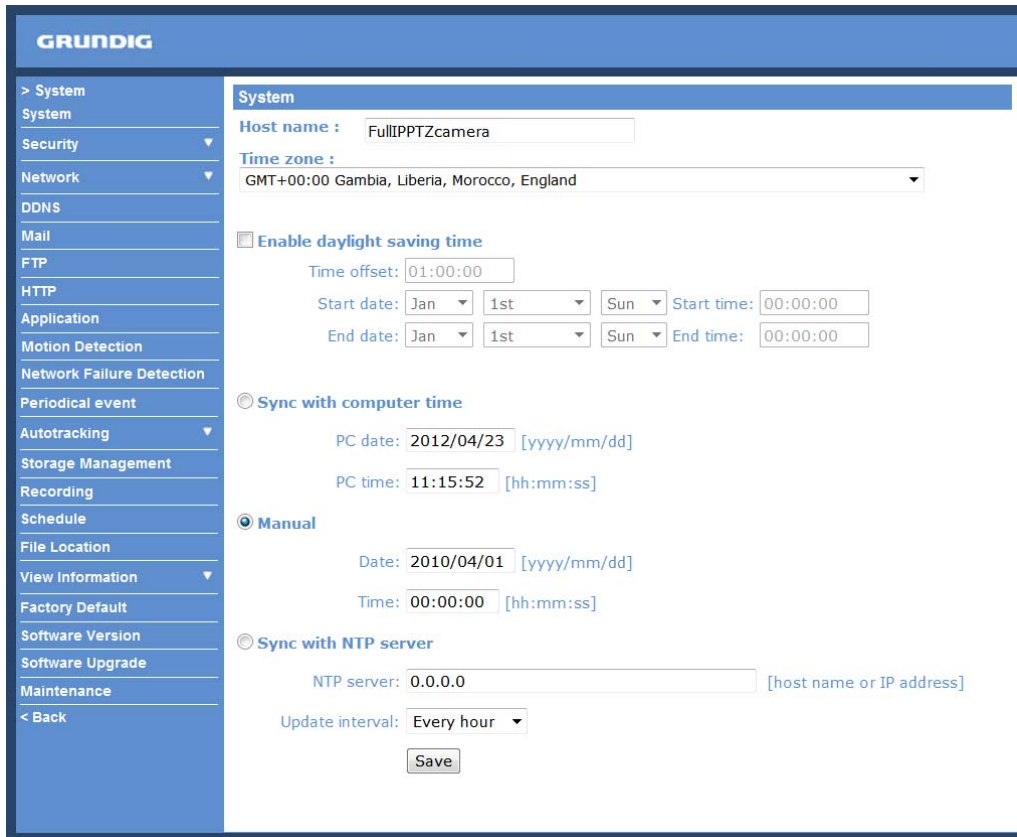

The screenshot displays the Grundig System configuration interface. On the left is a navigation menu with categories: > System, System, Security, Network, DDNS, Mail, FTP, HTTP, Application, Motion Detection, Network Failure Detection, Periodical event, Autotracking, Storage Management, Recording, Schedule, File Location, View Information, Factory Default, Software Version, Software Upgrade, Maintenance, and < Back. The main content area is titled 'System' and includes the following settings:

- Host name:** FullIPPTZcamera
- Time zone:** GMT+00:00 Gambia, Liberia, Morocco, England
- Enable daylight saving time:** (unchecked). Time offset: 01:00:00. Start date: Jan 1st Sun, Start time: 00:00:00. End date: Jan 1st Sun, End time: 00:00:00.
- Sync with computer time:** (selected). PC date: 2012/04/23 [yyyy/mm/dd]. PC time: 11:15:52 [hh:mm:ss].
- Manual:** (selected). Date: 2010/04/01 [yyyy/mm/dd]. Time: 00:00:00 [hh:mm:ss].
- Sync with NTP server:** (unchecked). NTP server: 0.0.0.0 [host name or IP address]. Update interval: Every hour. A Save button is located at the bottom.

9.1. Host Name & System Time Setting

Click on the first category <System> in the left column; the page is shown below.

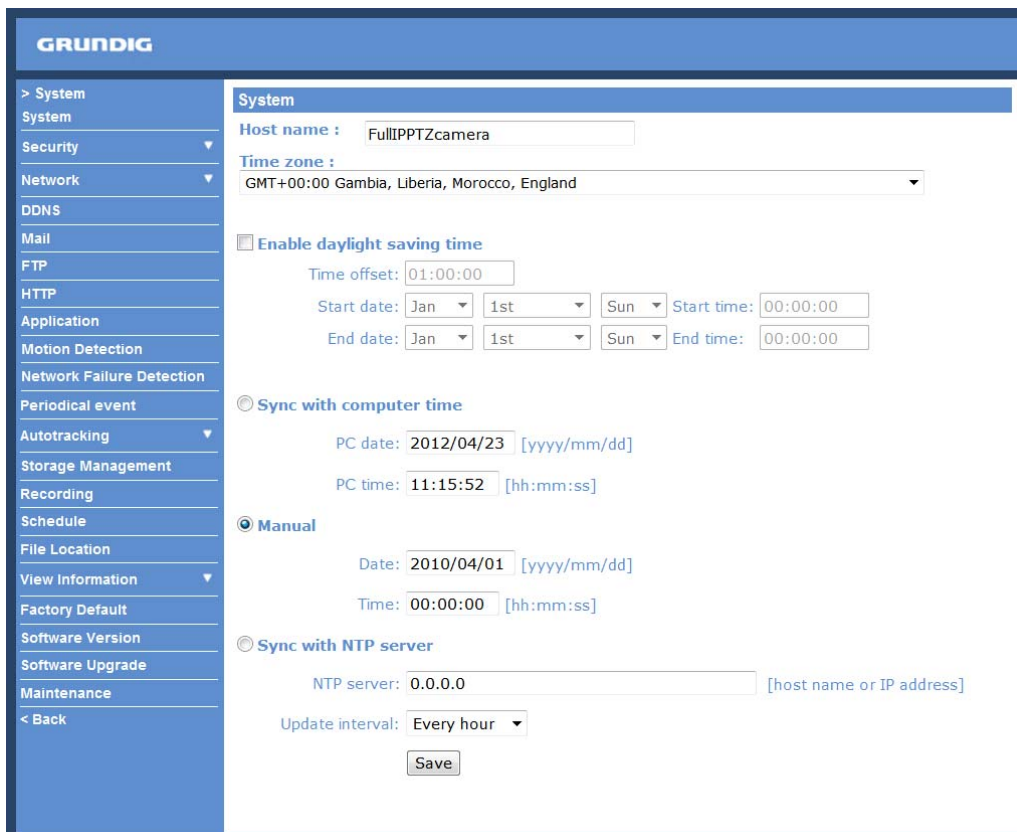

This screenshot is identical to the one above, showing the Grundig System configuration page with the same navigation menu and settings: Host name (FullIPPTZcamera), Time zone (GMT+00:00 Gambia, Liberia, Morocco, England), Daylight saving time (disabled), Sync with computer time (selected), Manual (selected), and Sync with NTP server (disabled).

Host Name :

The name is for camera identification (max. 30 characters). If the alarm function (see section 9.8. 'Application (Alarm Settings)') is enabled and is set to send an alarm message by Mail/FTP, the host name entered here will be displayed in the alarm message.

Time Zone :

Select the time zone you are in from the drop-down menu.

Enable Daylight Saving Time :

To enable DST, please check the item and then specify the time offset and DST duration. The format for time offset is [hh:mm:ss]; for instance, if the amount of time offset is one hour, please enter "01:00:00" into the field.

Sync with Computer Time :

After selecting this item, the video date and time display will be synchronised with the PC.

Manual :

The Administrator can set the date, time and day manually. Entry format should be identical with the format shown next to the enter fields.

Sync with NTP server :

Network Time Protocol (NTP) is an alternative way to synchronise your camera's clock with a NTP server. Please specify the server you wish to synchronise the camera with in the enter field. Then select an update interval from the drop-down menu. For further information about NTP, please see the web site: www.ntp.org.

NOTE: Click on < Save > to confirm the new setting.

9.2. Security

When you click on the category <Security>, there will be a drop-down menu with several tabs including <User>, <HTTPS>, <IP Filter>, and <IEEE 802.1X>.

<User> :

When you click on the <User> tab under the category <Security>, the <User> page will be shown as in the picture below.

The screenshot shows the Grundig web interface for the Security section, specifically the User management page. The left sidebar contains a navigation menu with categories like System, Security, Network, and Application. The main content area is titled 'Security' and has a sub-tab 'User'. It features three main sections: 'Admin password' with fields for 'Admin password' and 'Confirm password' and a 'Save' button; 'Add user' with fields for 'User name' and 'User password', and checkboxes for 'I/O access', 'Camera control', 'Talk', and 'Listen', along with an 'Add' button; and 'Manage user' with a 'User name' dropdown menu (currently showing '-- no user --') and 'Delete' and 'Edit' buttons.

NOTE: The following characters are valid: A-Z, a-z, 0-9, !#\$%&'-.@^_~.

Admin Password :

Change the administrator's password by putting in the new password in the "Admin password" and "Confirm password" text boxes. The input characters/numbers will be displayed as dots for security purposes. After clicking <Save>, the web browser will ask the Administrator for the new password for access. The maximum length of the password is 14 digits.

Add User :

Type in the new user name and password and click <Add> to add the new user. The user name can have up to 16 characters, the password up to 14 characters. The new user will be displayed in the user name list. A maximum of 20 user accounts can be set. To each user the privileges "Camera control", "Talk" and "Listen" can be assigned.

- I/O access:

This item supports fundamental functions that enable users to view the video when accessing the camera.

- Camera control:

This item allows the specified User to change the camera's parameters on the Camera Setting page.

- Talk/Listen:

Talk and Listen functions allow the appointed user on the local site (PC site) to communicate, for instance, with the administrator on the remote site.

Manage User :

To delete a user, pull down the user list, and select the user name you wish to delete. Then click <Delete> to remove it.

To edit a user, pull down the user list and select a user name. Click <Edit> to edit the user's password and privileges.

NOTE: It is required to enter the User password and to select the functions that will be open to the user. When finished, click <Save> to modify the account authority.

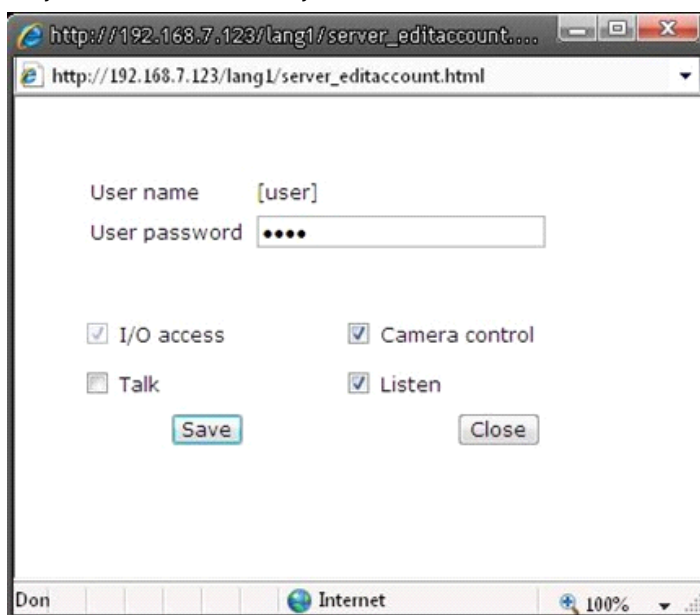

<HTTPS> :

<HTTPS> allows secure connections between the IP Camera and the web browser using the <Secure Socket Layer (SSL)> or the <Transport Layer Security (TLS)>, which prevent others from snooping on your camera settings or Username/Password. It is required to install a self-signed certificate or a CA-signed certificate for implementation of <HTTPS>.

After clicking on the <HTTPS> tab, the HTTPS setting page will be shown as in the figure below.

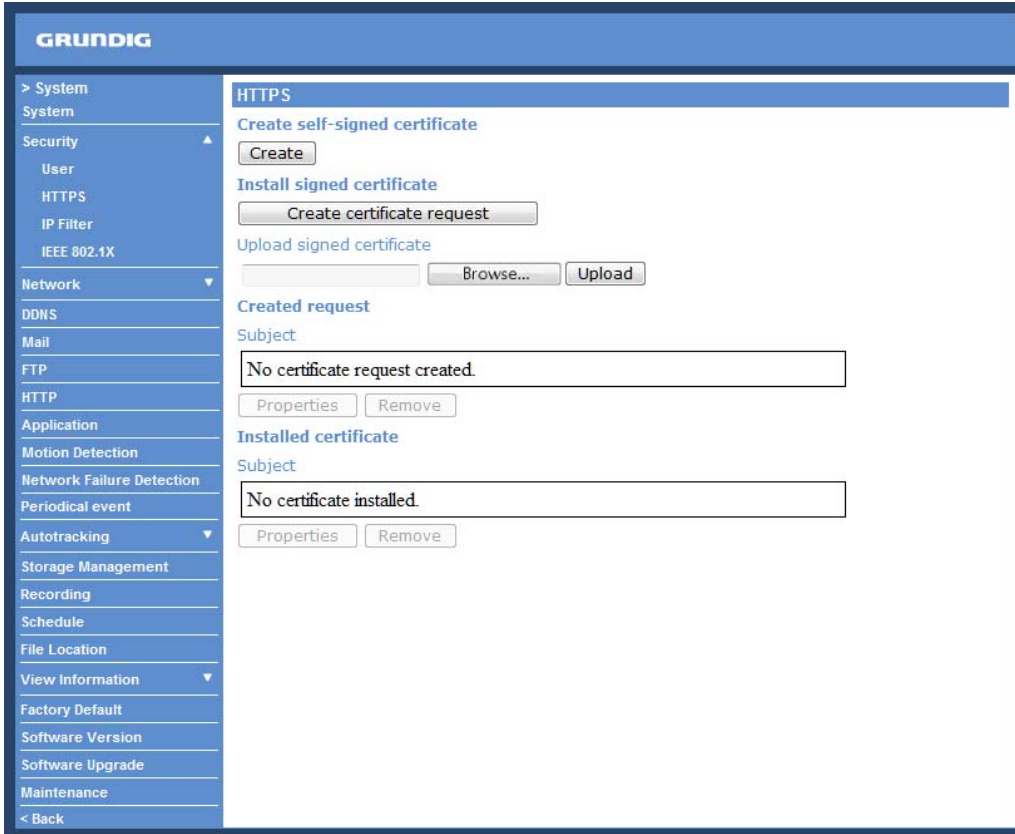

To use HTTPS on the IP Camera, a HTTPS certificate must be installed. The HTTPS certificate can be obtained by either creating and sending a certificate request to a Certificate Authority (CA) or creating a self-signed HTTPS certificate, as described below.

Create self-signed certificate :

Before a CA-issued certificate is obtained, users can create and install a self-signed certificate first.

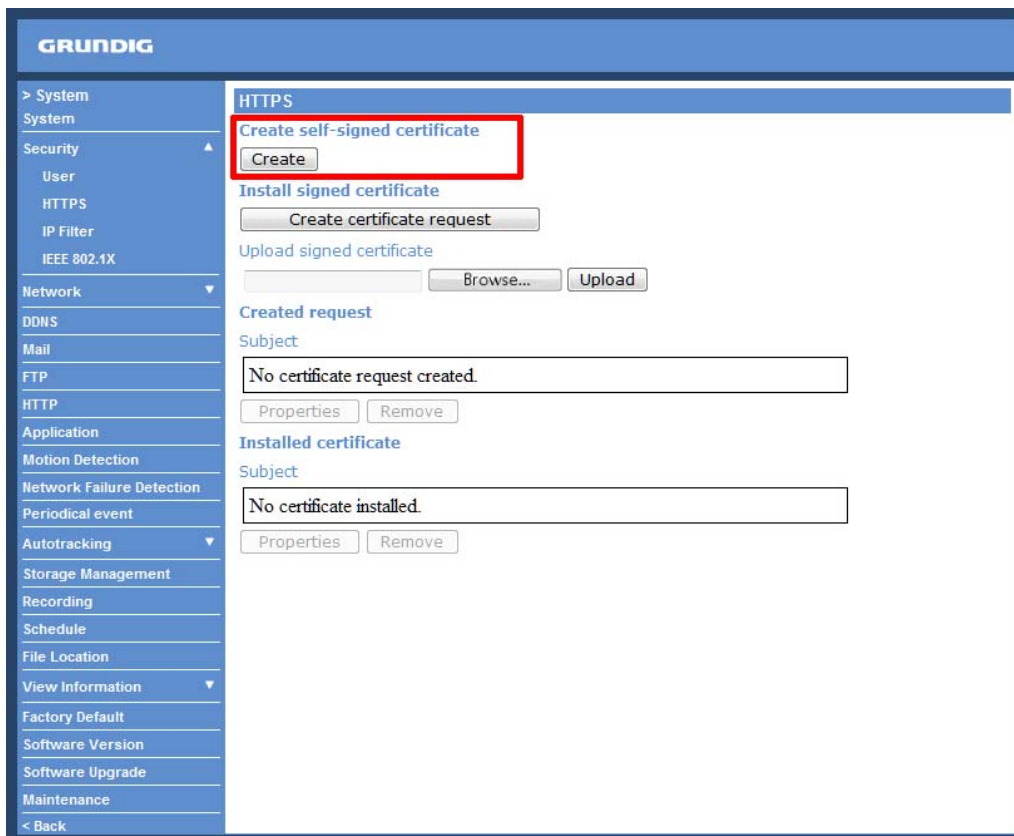

Click on the <Create> button under “Create self-signed certificate” and provide the requested information to install a self-signed certificate for the IP Camera. Please refer to the last part of this section: “Provide the Certificate Information” for more details.

NOTE: The self-signed certificate does not provide the same high level of security as when using a CA-issued certificate.

Install signed certificate :

Click on the "Create Certificate Request" button to create and submit a certificate request in order to obtain a signed certificate from the CA (Certificate Authority).

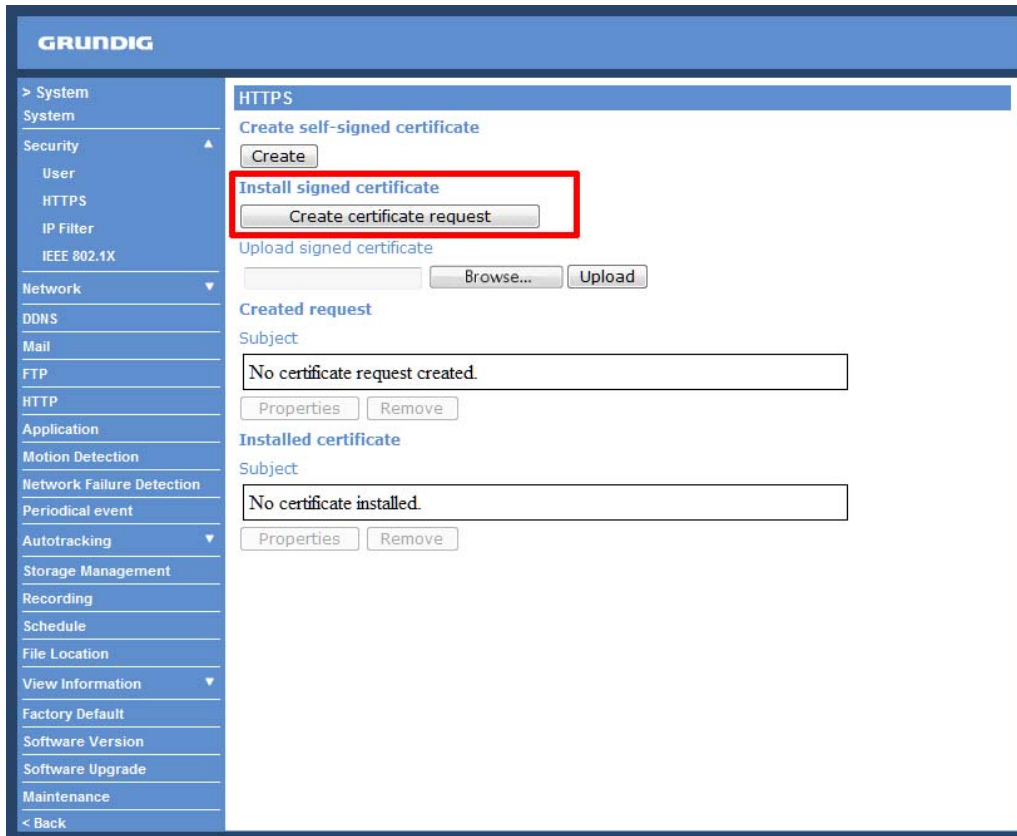

Provide the requested information in the Create Dialog. Please refer to the section "Provide the Certificate Information" for more details.

When the request is complete, the subject of the Created Request will be shown in the field. Click "Properties" below the Subject field, copy the PEM-formatted request and send it to your selected CA.

When the signed certificate is returned, install it by uploading the signed certificate.

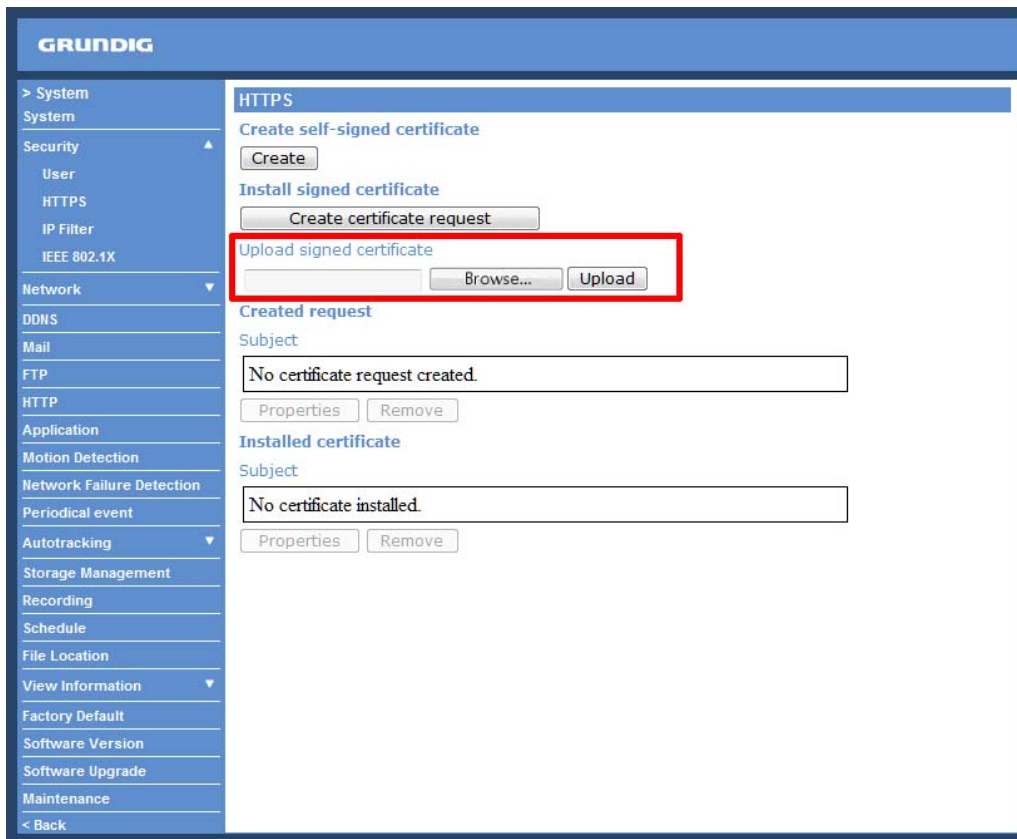

Provide the Certificate Information :

To create a Self-signed HTTPS Certificate or a Certificate Request to CA, please enter the information as requested:

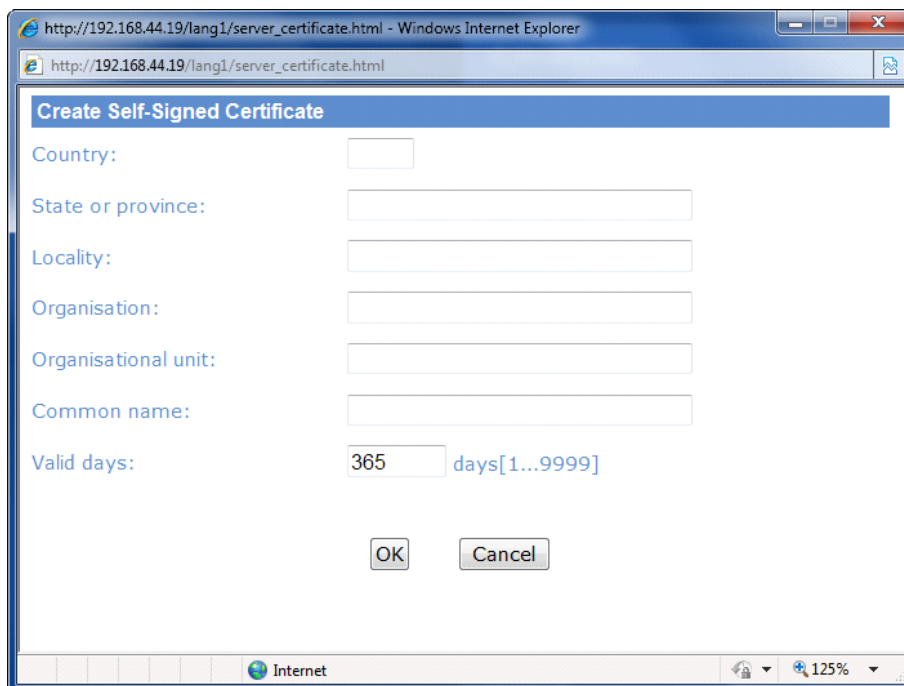

The image shows a screenshot of a web browser window titled "http://192.168.44.19/lang1/server_createrequest.html - Windows Internet Explorer". The browser's address bar displays "http://192.168.44.19/lang1/server_createrequest.html". The main content area features a form titled "Create Certificate Request" with a blue header. The form contains six text input fields, each with a label to its left: "Country:", "State or province:", "Locality:", "Organisation:", "Organisational unit:", and "Common name:". Below the input fields are two buttons: "OK" and "Cancel". The browser's status bar at the bottom shows "Internet" and a zoom level of "125%".

- Country:

Enter a 2-letter combination code to indicate the country the certificate will be used in. For instance, type in "GB" to indicate Great Britain.

- State or province:

Enter the local administrative region.

- Locality:

Enter other geographical information.

- Organisation:

Enter the name of the organisation to which the entity identified in "Common Name" belongs.

- Organisation Unit:

Enter the name of the organisational unit to which the entity identified in "Common Name" belongs.

- Common Name:

Indicate the name of the person or other entity that the certificate identifies (often used to identify the website).

- Valid days (Self-signed Certificate Only):

Enter the period in days (1~9999) to indicate the valid period of the certificate.

Click "OK" to save the Certificate Information after completing.

<IP Filter> :

When using the IP filter, access to the IP Camera can be restricted by denying/allowing specific IP addresses.

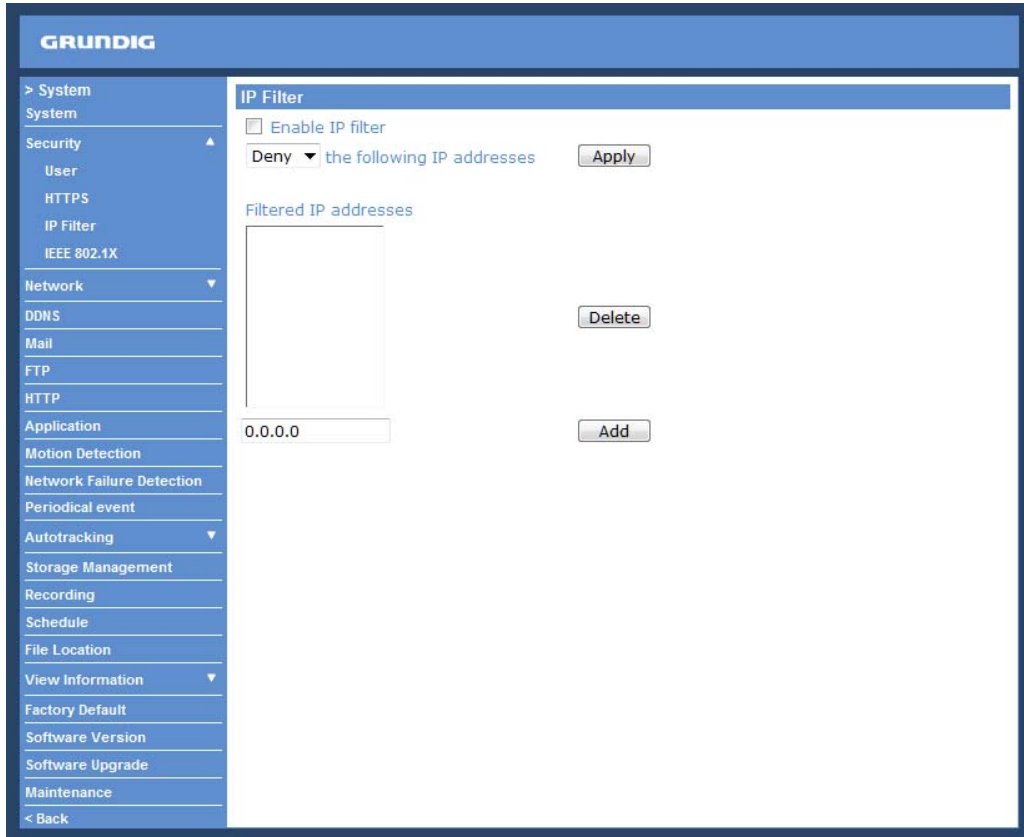

General :

- Enable IP Filter:

Check the box to enable the IP Filter function. Once enabled, access to the IP Camera will be allowed/denied for the listed IP addresses (IPv4).

Select "Allow" or "Deny" from the drop-down list and click the <Apply> button to determine the IP Filter behaviour.

- Add/Delete IP Address:

Input the IP address and click the <Add> button to add a new filtered address.

The Filtered IP Addresses list box shows the currently configured IP addresses. Up to 256 IP address entries may be specified.

To remove an IP address from the list, please select the IP and then click the <Delete> button.

<IEEE 802.1X> :

The IP Camera can access a network protected by 802.1X/EAPOL (Extensible Authentication Protocol over LAN). To do this, users need to contact the network administrator to receive certificates, user IDs and passwords.

The screenshot shows the Grundig web interface for configuring IEEE 802.1X/EAP-TLS. The left sidebar contains a navigation menu with categories like System, Security, Network, and Application. The main content area is titled 'IEEE 802.1X/EAP-TLS' and includes sections for 'CA certificate', 'Client certificate', 'Private key', and 'Settings'. Each section has a 'Browse...' button and an 'Upload' button. The 'Settings' section includes an 'Identity' field with the value 'admin', a 'Private key password' field with masked characters, and a checkbox for 'Enable IEEE 802.1X'. A 'Save' button is located at the bottom right of the settings area.

CA Certificate :

The CA certificate is created by the Certification Authority for the purpose of validating itself. Upload the certificate for checking the server's identity.

Client Certificate/Private Key :

Upload the Client Certificate and Private Key for authenticating the IP Camera itself.

Settings :

- Identity:

Enter the user identity associated with the certificate. Up to 16 characters can be used.

- Private Key Password:

Enter the password (maximum 16 characters) for your user identification.

Enable IEEE 802.1X :

Check the box to enable IEEE 802.1X.

Click "Save" to save the IEEE 802.1X/ EAP—TLS setting.

9.3. Network

When you click on the category <Network>, there will be a drop-down menu with several tabs including <Basic>, <QoS>, <SNMP>, and <UPnP>.

The screenshot shows the Grundig Network configuration interface. On the left is a navigation menu with categories like System, Security, Network, DDNS, Mail, FTP, HTTP, Application, Motion Detection, Network Failure Detection, Periodical event, Autotracking, Storage Management, Recording, Schedule, File Location, View Information, Factory Default, Software Version, Software Upgrade, Maintenance, and < Back. The main content area is titled 'Network' and contains three sections: 'General', 'Advanced', and 'IPv6 address configuration'. In the 'General' section, 'Use fixed IP address' is selected, and fields for IP address (192.168.1.1), Subnet mask (255.255.255.0), Default gateway (0.0.0.0), Primary DNS (0.0.0.0), and Secondary DNS (0.0.0.0) are visible. There are also fields for PPPoE User name and Password. The 'Advanced' section includes fields for Web server port (80), RTSP port (554), MJPEG over HTTP port (8008), and HTTPS port (443). The 'IPv6 address configuration' section has a checkbox for 'Enable IPv6' and an 'Address' field. Each section has a 'Save' button.

<Basic> :

Users can choose to connect to the IP Camera through a fixed or dynamic (DHCP) IP address. The IP Camera also provides PPPoE (Point-to-Point Protocol over Ethernet) support for users who connect to the network via PPPoE.

This is an identical copy of the screenshot above, showing the Grundig Network configuration page with the same settings and layout.

Get IP address automatically (DHCP):

The camera's default setting is "Use fixed IP address". Please refer to the previous section 6. Accessing the Camera for login with the default IP address.

If "Get IP address automatically" is selected, after the IP Camera restarts, users can search the IP address through the installer program "GRUNDIG Finder.exe", that is on the supplied CD.

NOTE: The DHCP function can only be used if you have a DHCP server in the used network.

NOTE: Please make a record of the IP Camera's MAC address, which can be found on the label of the camera, for identification in the future.

Use a fixed IP address :

To set up a static IP address, select "Use fixed IP address" and move the cursor to the IP address blank (as indicated below) and insert the new IP address, e.g. 192.168.44.230; then go to Default Gateway (explained later) and type in the appropriate setting, e.g. 192.168.44.1. Click on "Save" to confirm the new setting.

The screenshot shows the Grundig web interface for network configuration. The left sidebar contains a menu with options like System, Security, Network, Basic, QoS, SNMP, UPnP, DDNS, Mail, FTP, HTTP, Application, Motion Detection, Network Failure Detection, Periodical event, Autotracking, Storage Management, Recording, Schedule, File Location, View Information, Factory Default, Software Version, Software Upgrade, and Maintenance. The main content area is titled "Network" and has a "General" section. Under "General", there are two radio buttons: "Get IP address automatically" (unselected) and "Use fixed IP address" (selected). Below these are input fields for "IP address" (192.168.44.230), "Subnet mask" (255.255.255.0), "Default gateway" (192.168.44.1), "Primary DNS" (0.0.0.0), and "Secondary DNS" (0.0.0.0). There is also a "Use PPPoE" section with "User name" and "Password" fields, and a "Save" button. Below that is an "Advanced" section with "Web server port" (80), "RTSP port" (554), "MJPEG over HTTP port" (8008), and "HTTPS port" (443), with a "Save" button. At the bottom is an "IPv6 address configuration" section with an "Enable IPv6" checkbox and an "Address" field with a "Save" button.

When using a static IP address to login to the IP Camera, users can access it either through the "GRUNDIG Finder" software (see 6. Accessing the Camera) or input the IP address in the URL bar and click on "Enter".

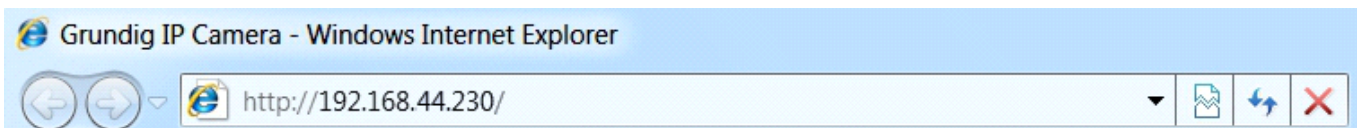

- IP address:

This is necessary for network identification.

- Subnet mask:

It is used to determine if the destination is in the same subnet. The default value is "255.255.255.0".

- Default gateway:

This is the gateway used to forward frames to destinations in different subnets. An invalid gateway setting will fail in the transmission to destinations in different subnets.

- Primary DNS:

Primary DNS is the primary domain name server that translates hostnames into IP addresses.

- Secondary DNS:

Secondary DNS is a secondary domain name server that backs up the primary DNS.

Use PPPoE :

The PPPoE users need to enter the PPPoE Username and Password into the fields, and need to click on the "Save" button to complete the setting.

Advanced :

- Web Server port:

The default web server port is 80. Once the port is changed, all users must be informed about the change for the connection to be successful. For instance, when the Administrator changes the HTTP port of the IP Camera which has the IP address "192.168.0.100" from 80 to 8080, the users must type in in the web browser "http://192.168.0.100:8080" instead of "http://192.168.0.100".

- RTSP port:

The default setting of the RTSP Port is 554; the setting range is from 1024 to 65535.

- MJPEG over HTTP port:

The default setting of the MJPEG over HTTP Port is 8008; the setting range is from 1024 to 65535.

- HTTPS port:

The default setting of the HTTPS Port is 443; the setting range is from 1024 to 65535.

NOTE: Be aware to assign a different port number for each separate service mentioned above.

IPv6 Address Configuration :

With IPv6 support, users can use the corresponding IPv6 address for browsing. Enable IPv6 by checking the box and click "Save" to complete the setting.

<QoS> (Quality of Service) :

QoS allows providing differentiated service levels for different types of traffic packets which guarantees delivery of priority services especially when network congestion occurs. Adapting the Differentiated Services (DiffServ) model, traffic flows are classified and marked with DSCP (DiffServ Codepoint) values, and thus receive the corresponding forwarding treatment from DiffServ capable routers.

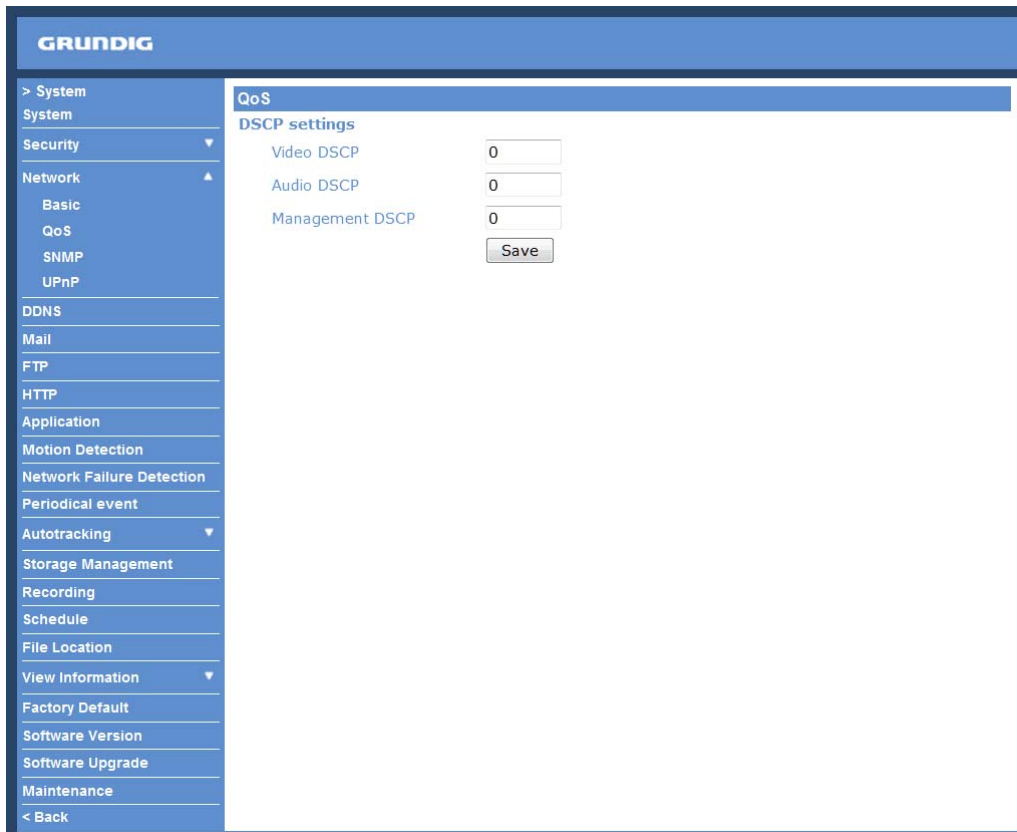

DSCP Settings :

The DSCP value range is from 0 to 63. The default DSCP value is 0, which means that DSCP is disabled.

The IP Camera uses the following QoS Classes: Video, Audio and Management.

- Video DSCP:

This class consists of applications such as MJPEG over HTTP, RTP/RTSP and RTSP/HTTP.

- Audio DSCP:

This setting is only available for the IP Cameras which support audio.

- Management DSCP:

This class consists of the HTTP traffic: Web browsing.

Click the "Save" button to complete the setting.

NOTE: To enable this function, please make sure the switches/routers in the network support QoS.

<SNMP> (Simple Network Management Protocol) :

With Simple Network Management Protocol (SNMP) support, the IP Camera can be monitored and managed remotely by the network management system.

The screenshot shows the Grundig web interface for configuring SNMP. The left sidebar contains a navigation menu with the following items: > System, System, Security, Network (Basic, QoS, SNMP, UPnP), DDNS, Mail, FTP, HTTP, Application, Motion Detection, Network Failure Detection, Periodical event, Autotracking, Storage Management, Recording, Schedule, File Location, View Information, Factory Default, Software Version, Software Upgrade, Maintenance, and < Back. The main content area is titled 'SNMP Settings' and includes the following sections:

- SNMP v1/v2**:
 - Enable SNMP v1
 - Enable SNMP v2
 - Read community: public
 - Write community: private
- Traps for SNMP v1/v2**:
 - Enable traps
 - Trap address: [text box]
 - Trap community: public
- Trap options**:
 - Warm start

A 'Save' button is located at the bottom of the settings area.

SNMP v1/v2 :

- Enable SNMP:

Select the version of SNMP to use by checking the corresponding box.

- Read Community:

Specify the community name which has read-only access to all supported SNMP objects. The default value is "public".

- Write Community:

Specify the community name which has read/write access to all supported SNMP objects (except read-only objects). The default value is "private".

Traps for SNMP v1/v2 :

Traps are used by the IP Camera to send messages to a management system about important events or status changes.

- Enable Traps:

Check the box to activate trap reporting.

- Trap address:

Enter the IP address of the management server.

- Trap community:

Enter the community to use when sending a trap message to the management system.

Trap option :

- Warm start:

A Warm start SNMP trap signifies that the SNMP device, i.e. the IP Camera, performs a software reload.

Click the "Save" button to complete the setting.

<UPnP> :

The screenshot displays the Grundig web interface for configuring UPnP settings. On the left is a blue sidebar menu with the following items: > System, System, Security (with a dropdown arrow), Network (with an up arrow), Basic, QoS, SNMP, UPnP, DDNS, Mail, FTP, HTTP, Application, Motion Detection, Network Failure Detection, Periodical event, Autotracking (with a dropdown arrow), Storage Management, Recording, Schedule, File Location, View Information (with a dropdown arrow), Factory Default, Software Version, Software Upgrade, Maintenance, and < Back. The main content area is titled 'UPnP' and contains the 'UPnP Setting' section. It features two checkboxes: 'Enable UPnP' which is checked, and 'Enable UPnP port forwarding' which is unchecked. Below these is a text input field labeled 'Friendly name' containing the value 'GCI-K0779P'. A 'Save' button is positioned at the bottom of the settings area.

UPnP Setting :

- Enable UPnP:

When UPnP is enabled, whenever the IP Camera is presented to LAN, the icon of the connected IP Cameras will appear in My Network Places to allow for direct access as shown below.

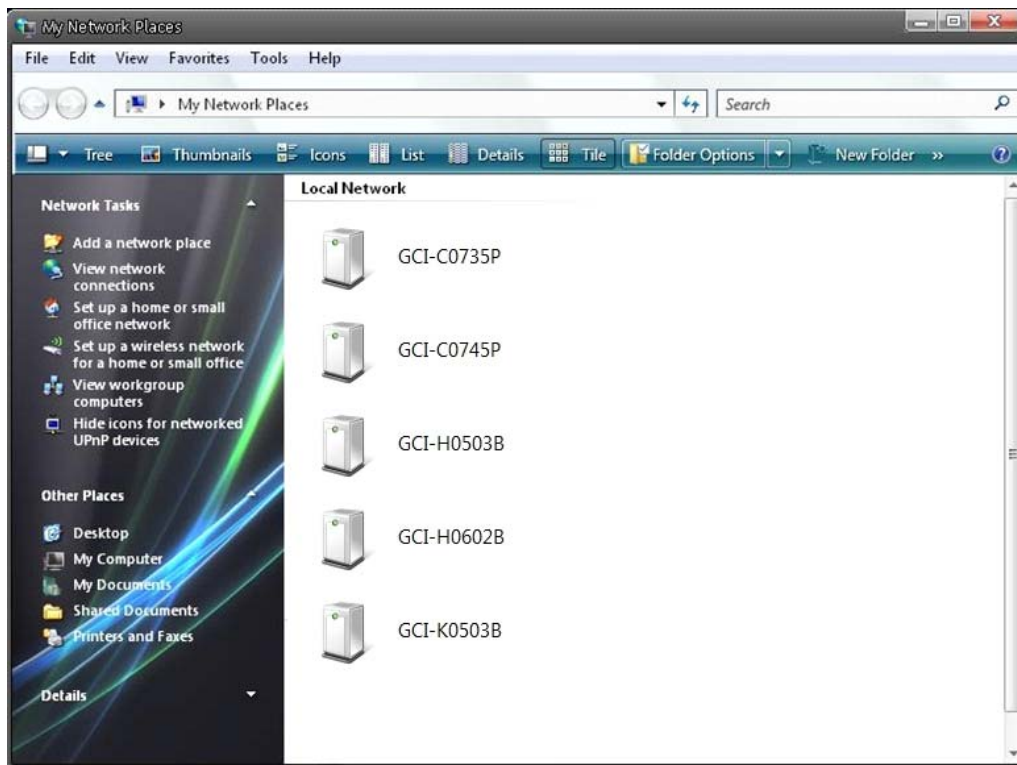

NOTE: To enable this function, please make sure the UPnP component is installed on your computer. Please refer to chapter 16. Install UPnP Components for UPnP component installation procedure.

- Enable UPnP port forwarding:

When UPnP port forwarding is enabled, the IP Camera is allowed to open the web server port on the router automatically.

NOTE: To enable this function, please make sure that your router supports UPnP and is activated.

- Friendly name:

Set the name of the IP Camera for identification.

9.4. DDNS

The Dynamic Domain Name System (DDNS) allows a host name to be constantly synchronised with a dynamic IP address. In other words, it allows those using a dynamic IP address to be associated to a static domain name so that others can connect to it through this name.

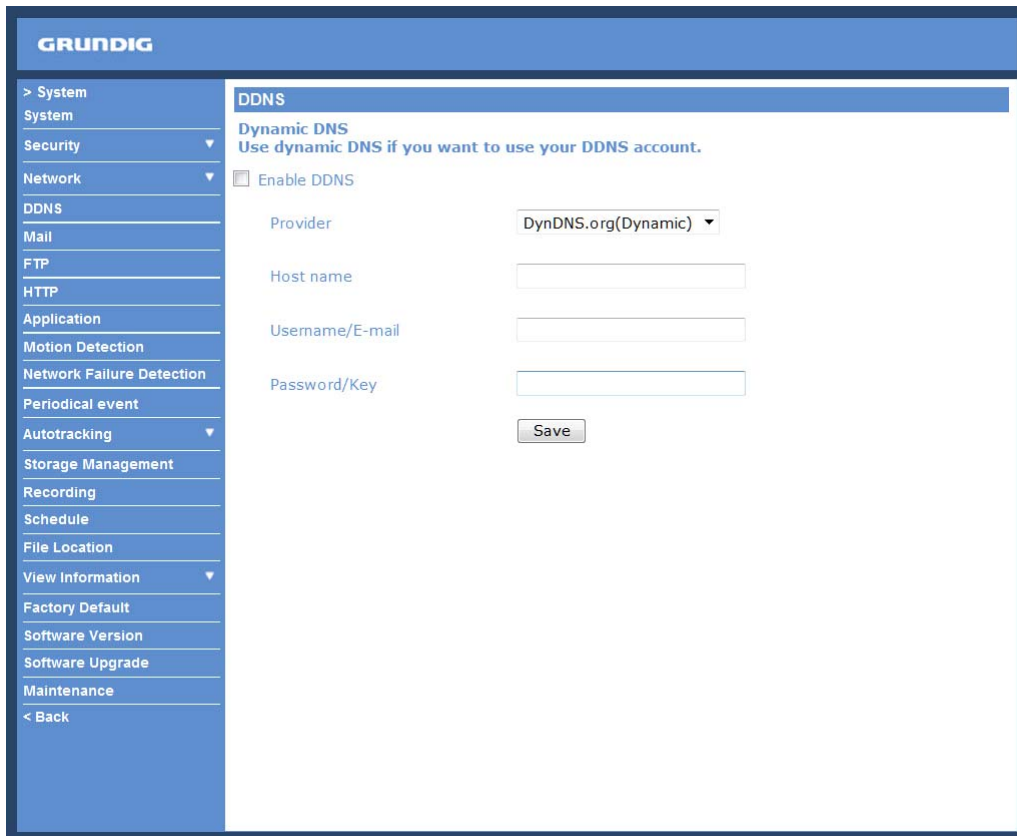

The screenshot shows the Grundig DDNS configuration interface. The left sidebar contains a menu with the following items: > System, System, Security, Network, DDNS, Mail, FTP, HTTP, Application, Motion Detection, Network Failure Detection, Periodical event, Autotracking, Storage Management, Recording, Schedule, File Location, View Information, Factory Default, Software Version, Software Upgrade, Maintenance, and < Back. The main content area is titled 'DDNS' and contains the following elements:

- Dynamic DNS**
Use dynamic DNS if you want to use your DDNS account.
- Enable DDNS
- Provider: DynDNS.org(Dynamic) (dropdown menu)
- Host name: [text input field]
- Username/E-mail: [text input field]
- Password/Key: [text input field]
- Save (button)

Enable DDNS :

Check the item to enable DDNS.

Provider :

Select one DDNS host from the provider list.

Host name :

Enter the registered domain name in the field.

Username/E-mail :

Enter the user name or e-mail required by the DDNS provider for authentication.

Password/Key :

Enter the password or key required by the DDNS provider for authentication.

9.5. Mail

The Administrator can set up the sending of an e-mail via Simple Mail Transfer Protocol (SMTP) when an event is triggered. SMTP is a protocol for sending e-mail messages from server to server. SMTP is a relatively simple, text-based protocol, where one or more recipients of a message are specified and to whom the message text is transferred.

The configuration page is shown below:

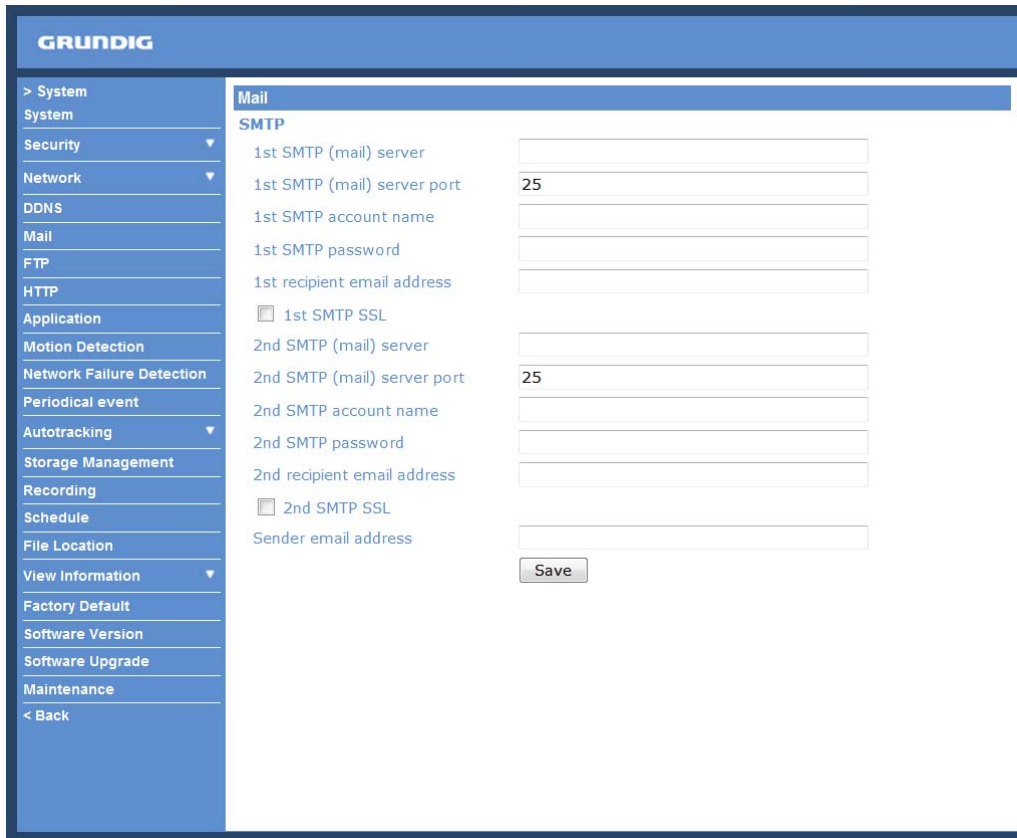

The screenshot shows the Grundig web interface for configuring mail settings. On the left is a navigation menu with categories like System, Security, Network, DDNS, Mail, FTP, HTTP, Application, Motion Detection, Network Failure Detection, Periodical event, Autotracking, Storage Management, Recording, Schedule, File Location, View Information, Factory Default, Software Version, Software Upgrade, and Maintenance. The main content area is titled 'Mail' and contains an 'SMTP' section. It lists two SMTP servers. The first server has fields for '1st SMTP (mail) server', '1st SMTP (mail) server port' (set to 25), '1st SMTP account name', '1st SMTP password', and '1st recipient email address'. There is a checkbox for '1st SMTP SSL'. The second server has fields for '2nd SMTP (mail) server', '2nd SMTP (mail) server port' (set to 25), '2nd SMTP account name', '2nd SMTP password', and '2nd recipient email address'. There is a checkbox for '2nd SMTP SSL'. At the bottom of the form is a 'Sender email address' field and a 'Save' button.

Two sets of SMTP can be configured. Each set includes the SMTP Server, Server Port, Account Name, Password and E-mail Address settings. Check the box "SMTP SSL" to send emails via encrypted transmission. Concerning the SMTP server, contact your network service provider for more specific information.

Click the "Save" button to save the changes.

9.6. FTP

The Administrator can set the sending of alarm messages to a specific File Transfer Protocol (FTP) site when an event is detected. Users can assign an alarm message to up to two FTP sites. The FTP setting page is shown below. Enter the FTP details, which include server, server port, user name, password and remote folder, into the fields. Check the box "passive mode" to be connected to the FTP server by passively receiving the FTP server's IP address through a dynamic port. Alternatively, uncheck the box to directly connect with the FTP server via active mode.

Click "Save" when the setting is finished.

The screenshot shows the Grundig FTP configuration interface. The left sidebar contains a navigation menu with the following items: > System, System, Security, Network, DDNS, Mail, FTP, HTTP, Application, Motion Detection, Network Failure Detection, Periodical event, Autotracking, Storage Management, Recording, Schedule, File Location, View Information, Factory Default, Software Version, Software Upgrade, Maintenance, and < Back. The main content area is titled 'FTP' and contains the following fields and options:

- 1st FTP server: [Text input field]
- 1st FTP server port: [Text input field with value '21']
- 1st FTP user name: [Text input field]
- 1st FTP password: [Text input field]
- 1st FTP remote folder: [Text input field]
- 1st FTP passive mode
- 2nd FTP server: [Text input field]
- 2nd FTP server port: [Text input field with value '21']
- 2nd FTP user name: [Text input field]
- 2nd FTP password: [Text input field]
- 2nd FTP remote folder: [Text input field]
- 2nd FTP passive mode
- [Save button]

9.7. HTTP

A HTTP Notification server can listen for notification messages from IP Cameras by triggered events. The HTTP setting page is shown below. Enter the HTTP details, which include the server name (for instance, http://192.168.1.1/admin.php), user name, and password into the fields. <Alarm> triggered and <Motion Detection> notifications can then be sent to the specified <HTTP> server.

Click "Save" when the setting is finished.

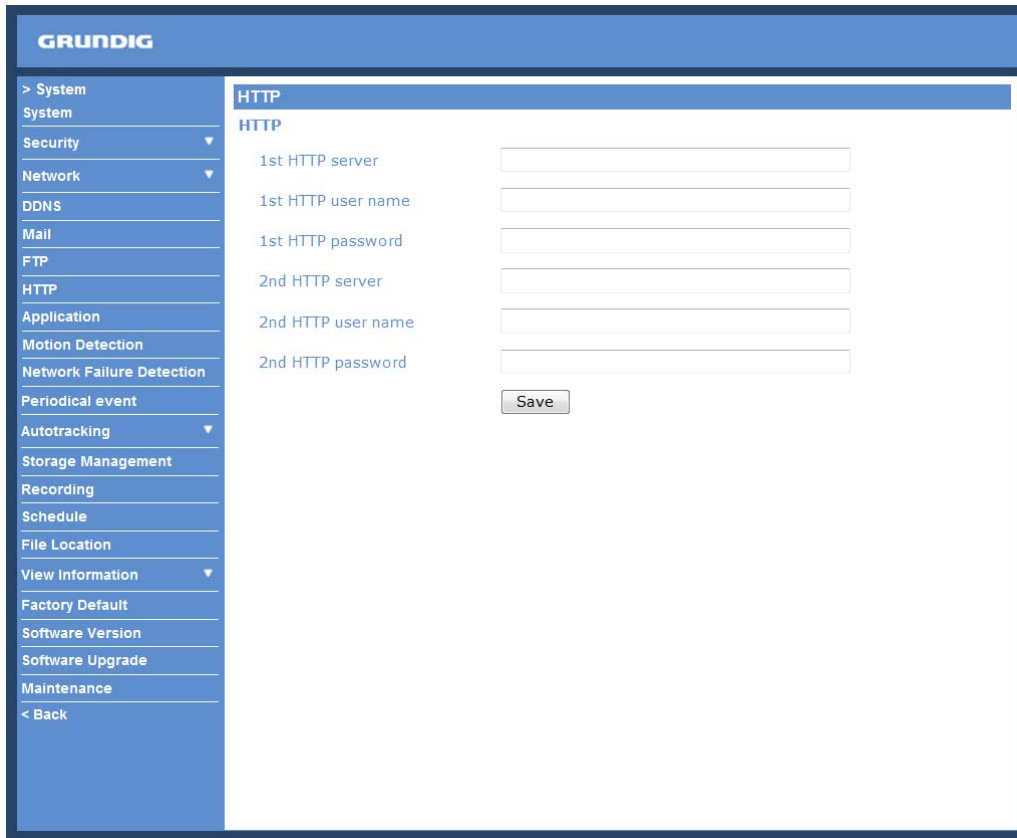

Please also refer to: 9.8. Application (Alarm Settings): Send HTTP notification / 9.9. Motion Detection for HTTP Notification settings.

9.8. Application (Alarm Settings)

The Camera is equipped with four alarm inputs and two relay outputs for cooperating with an alarm system to catch the images of an event. Please refer to 4.5. Alarm Connection for Alarm Pin Definition to connect the alarm devices.

Alarm Pin Selection :

Select an alarm pin which is to be configured from the "Alarm Pin Selection" field. Then click on the button "Edit" below the field to carry on with alarm programming.

Alarm Status Settings :

The specific alarm pin's property can be programmed in this section as shown below.

The screenshot shows the Grundig web interface for Alarm Status Settings. The left sidebar contains a navigation menu with the following items: > System, System, Security, Network, DDNS, Mail, FTP, HTTP, Application, Motion Detection, Network Failure Detection, Periodical event, Autotracking, Storage Management, Recording, Schedule, File Location, View Information, Factory Default, Software Version, Software Upgrade, Maintenance, and < Back. The main content area is titled 'Application' and contains the following sections:

- Alarm pin selection:** A table with columns 'Alarm', 'Switch', and 'Type'.

| Alarm | Switch | Type |
|-------|--------|--------------|
| 1. | On | Normal close |
| 2. | Off | Normal open |
| 3. | Off | Normal open |
| 4. | Off | Normal open |

An 'Edit' button is located below the table.
- Alarm pin1 status:** A section with the title 'Alarm setting'. It includes:
 - 'Alarm switch' set to 'On'.
 - 'Alarm type' set to 'Normal close'.
 - Triggered action:** A list of actions with checkboxes:
 - Enable alarm output 1
 - Enable alarm output 2
 - Send message by FTP
 - Send message by E-Mail
 - Upload image by FTP
 - Upload image by E-Mail
 - PTZ Function
 - Send HTTP notification
 - Record stream to sd card
- File name:** A text input field containing 'image.jpg'. Below it are radio button options:
 - Add date/time suffix
 - Add sequence number suffix (no maximum value)
 - Add sequence number suffix up to [0] and then start over
 - Overwrite
- A 'Save' button.

Alarm Switch :

The Administrator can enable or disable the alarm function.

Alarm Type :

Select an alarm type, "Normal close" or "Normal open", that corresponds with the alarm application.

Alarm Output :

Define the alarm output signal as "high" or "low" for the normal alarm output status according to the current alarm application.

Triggered Action (Multi-option) :

The Administrator can specify alarm actions that will take place when the alarm is triggered. All options are listed as follows:

- Enable Alarm Output 1/2:

Check this item and select the predefined type of alarm output to enable alarm relay output when motion is detected.

- Send Message by FTP:

The Administrator can choose to send an alarm message by FTP when an alarm is detected.

- Send Message by E-Mail:

The Administrator can choose to send an alarm message by E-Mail when an alarm is triggered.

- Upload Image by FTP:

After selecting this item, the Administrator can assign a FTP site and configure various parameters as shown in the picture below. When a motion is detected, event images will be uploaded to the appointed FTP site.

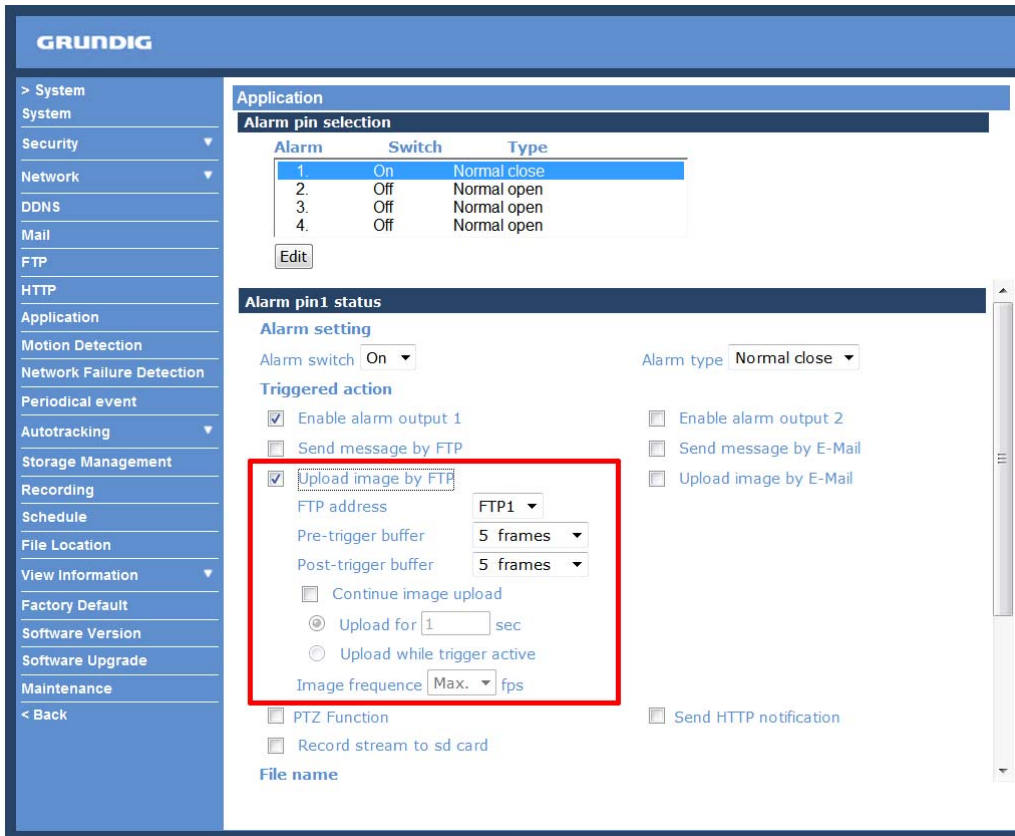

The <Pre-trigger buffer> recording function allows users to check what happened to trigger the alarm. The pre-trigger buffer time range is from 1 to 20 frames.

On the other hand, the <Post-trigger buffer> is for uploading a certain amount of images after the alarm input is triggered. The post-trigger buffer time range is from 1 to 20 frames.

Check the box <Continue image upload> to upload the triggered images during a certain time or keep uploading until the trigger is off.

- Select <Upload for __sec> and enter the duration in the blank. The images of the duration will be uploaded by E-Mail when the alarm input is triggered. The setting range is from 1 to 9999 seconds.

- Select <Upload while trigger is active> to keep the images being uploaded via E-Mail while the trigger is active, i.e. until the alarm is stopped.

Set the Image frequency as the upload frame rate. The setting range is from 1 frame to 15 frames.

- Upload Image by E-Mail:

After selecting this item, the Administrator can assign an e-mail address and configure various parameters as shown in the figure below. When the alarm is triggered, event images will be sent to the appointed e-mail address.

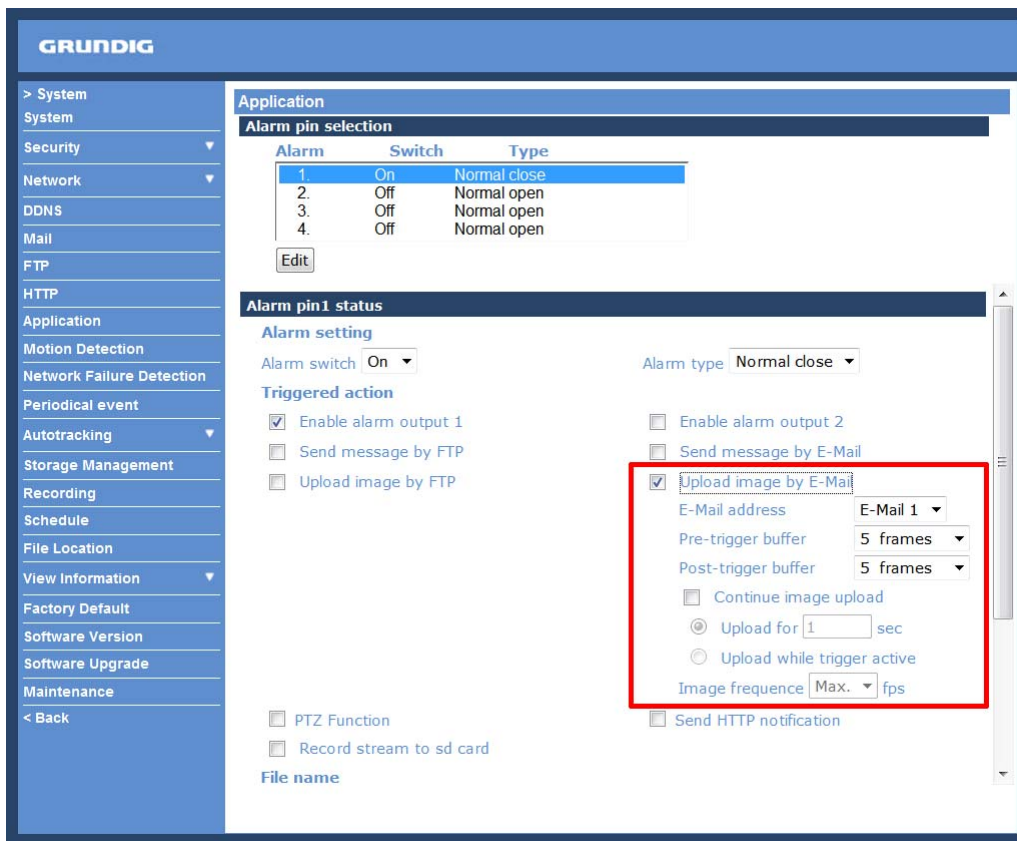

The <Pre-trigger buffer> recording function allows users to check what happened to trigger the alarm. The pre-trigger buffer time range is from 1 to 20 frames.

On the other hand, the <Post-trigger buffer> is for uploading a certain amount of images after the alarm input is triggered. The post-trigger buffer time range is from 1 to 20 frames.

Check the box <Continue image upload> to upload the triggered images during a certain time or keep uploading until the trigger is off.

- Select <Upload for __sec> and enter the duration in the blank. The images of the duration will be uploaded to the FTP when the alarm input is triggered. The setting range is from 1 to 9999 seconds.

- Select <Upload while trigger is active> to keep the images being uploaded to the FTP while the trigger is active, i.e. until the alarm is stopped.

Set the Image frequency as the upload frame rate. The setting range is from 1 frame to 15 frames.

NOTE: Make sure SMTP or FTP configuration has been completed. See section 9.5. Mail and 9.6. FTP for further details.

- PTZ Function:

Assign a camera function: Preset, Sequence, Auto Pan or Cruise, and specify a Preset Point/Sequence Line/Auto Pan Path/Cruise Line for the camera to perform at an alarm occurrence.

NOTE: Please refer to the sections through 11.1. Preset Programming to 11.4. Sequence Line Programming for details of Preset Point / Sequence Line / Auto Pan Path / Cruise Line setups.

If the selected function is “Preset”, it is required to enter its dwell time (1 ~ 256 sec.) in the corresponding field as shown below. When the alarm is triggered, the camera will go to the selected Preset Point and stay there for a user-defined period of time. As for other function modes, the camera will keep executing the specified function; to stop the performance, simply change the camera’s status.

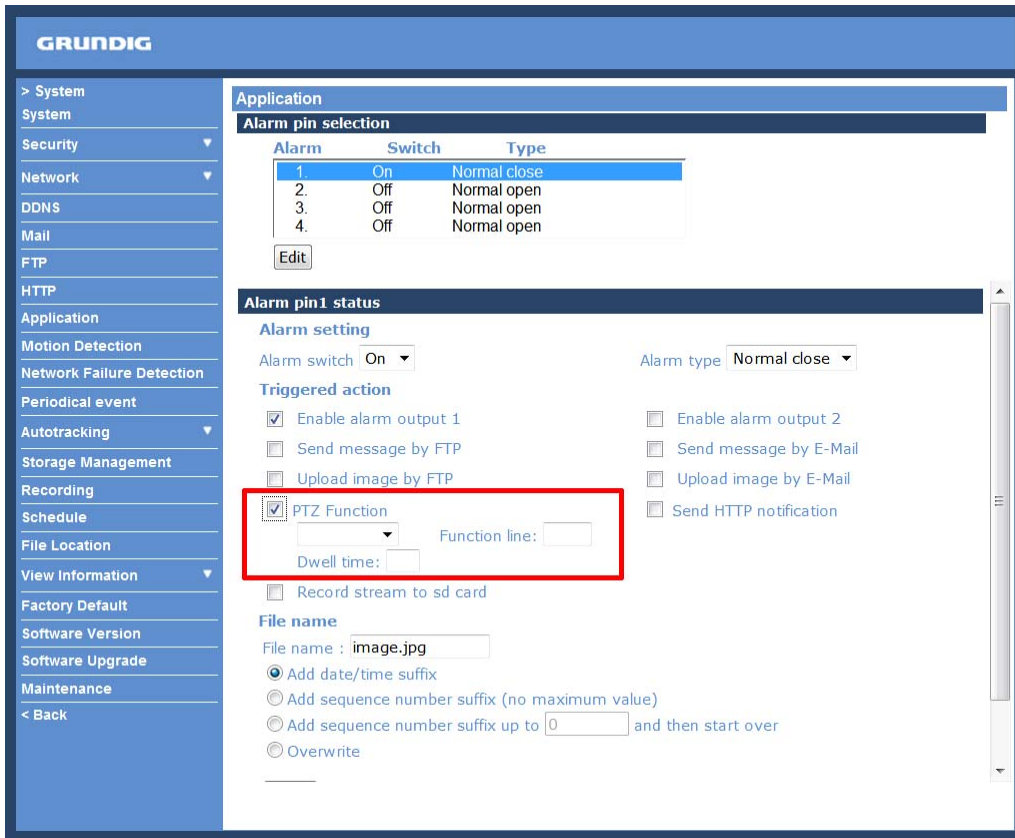

NOTE: The dwell time is only adjustable when selecting Preset as the alarm action. When the dwell time is up, the Motordome Camera will go back to its trigger position and recheck alarm pin status.

- Send HTTP notification:

Check this item, select the destination HTTP address, and specify the parameters for event notifications when <Motion Detection> is triggered. When an alarm is triggered, the notification can be sent to the specified HTTP server.

For instance, if the custom parameter is set as "action=1&group=2", and the HTTP server's name is "http://192.168.1.200/admin.php", the notification will be sent to the HTTP server as "http://192.168.1.200/admin.php? Action=1&group=2" when an alarm is triggered.

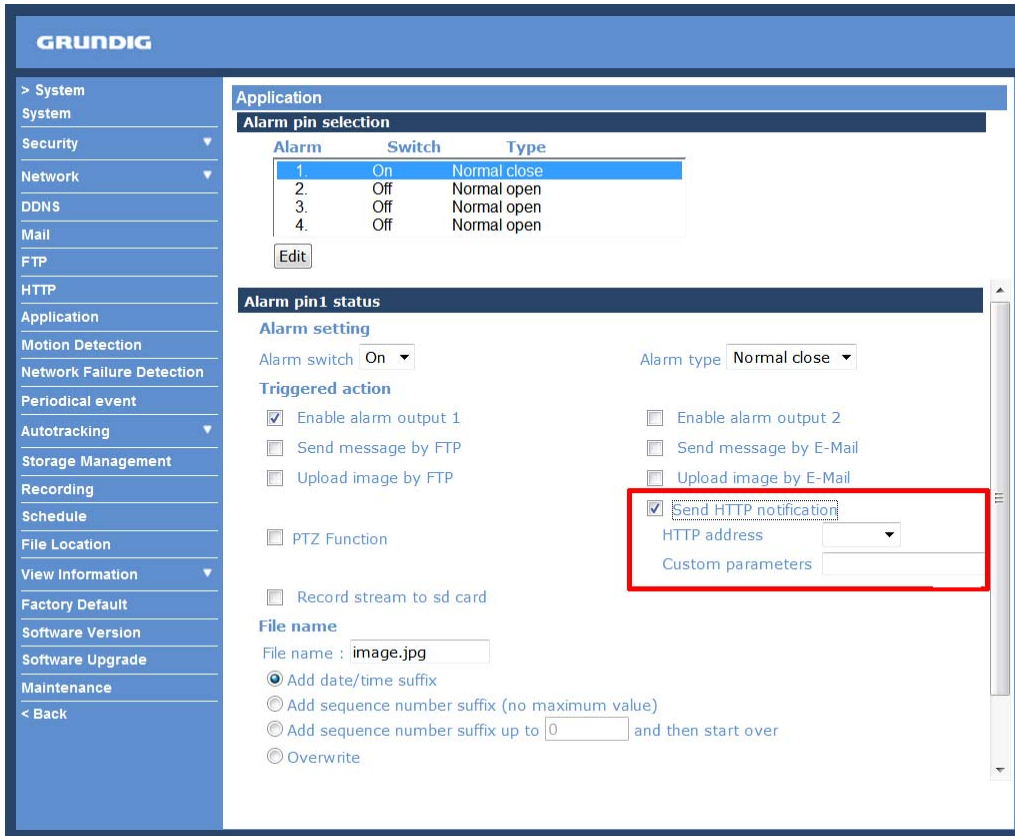

- Record Stream to SD Card:

When you check this item, the alarm-triggered recording will be stored on your Micro SD/SDHC card when tampering is detected.

The pre-trigger buffer recording function allows users to check what happened to trigger the alarm. The pre-trigger buffer time range is from 1 to 3 seconds.

Select <Upload for __ sec> to set the recording duration after the alarm is triggered. The setting range is from 1 to 99999 seconds.

Select <Upload while trigger is active> to record the triggered video until the trigger is turned off.

NOTE: Please make sure that the local recording (with Micro SD/SDHC card) is activated so that this function can be implemented. See section 9.14. Recording (on Camera) for further details.

File Name :

Enter a file name into the blank box, e.g. image.jpg. The uploaded image's file name format can be set in this section. Please select the one that meets your requirements.

- Add date/time suffix:

File name: imageYMMDD_HHNNSS_XX.jpg

Y: Year, M: Month, D: Day

H: Hour, N: Minute, S: Second

X: Sequence Number

- Add sequence number suffix (no maximum value):

File name: imageXXXXXX.jpg

X: Sequence Number

- Add sequence number suffix up to _ and then start over:

File Name: imageXX.jpg

X: Sequence Number

The file name suffix will end at the number being set. For example, if the setting is "10", the file name will start from 00, end at 10, and then start all over again.

- Overwrite:

The original image in the FTP site will be overwritten with a static filename by the new uploaded file.

Save :

After completing all the settings mentioned above, please click on the Save button to save all the settings in this page.

9.9. Motion Detection

The Motion Detection function allows detecting suspicious motion and triggers alarms when motion volume in the detected area reaches/exceeds the determined sensitivity threshold value.

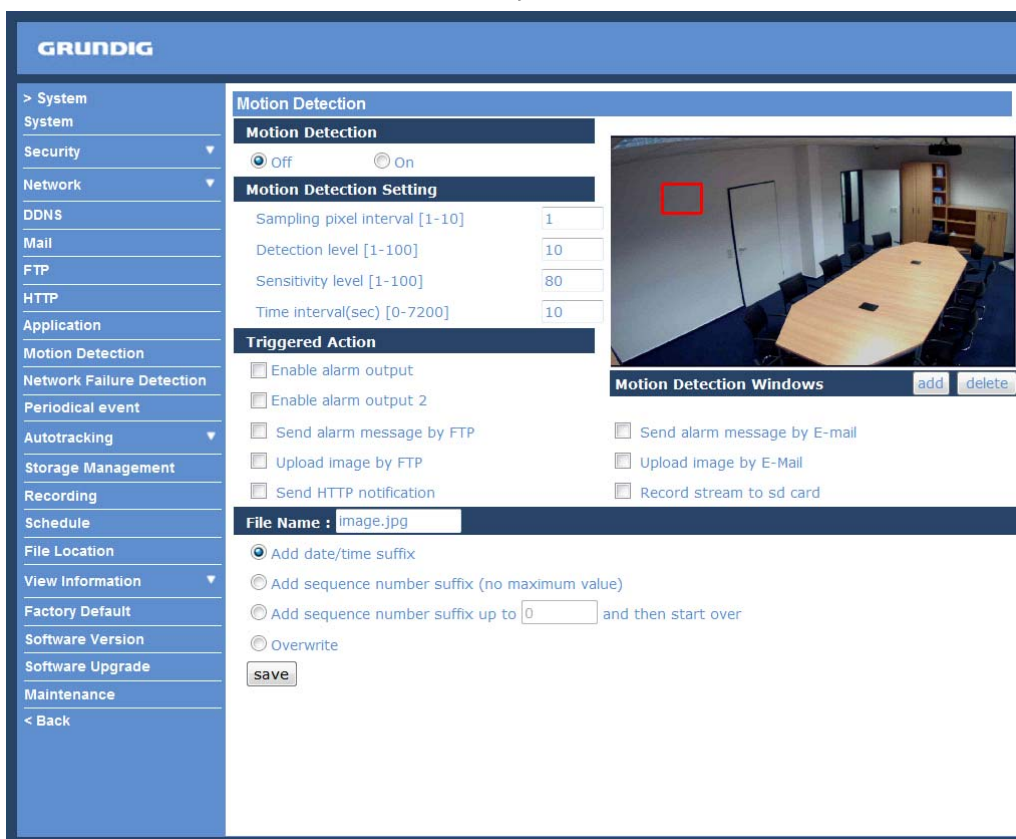

In the Motion Detection setting page a frame (Motion Detection Window) is displayed in the Live View Pane. The Motion Detection Window is for defining the motion detection area. To change the size of the Motion Detection Window, move the mouse cursor to the edge of the frame and draw it outward/inward. When you move the mouse cursor to the center of the frame and hold the click, you can shift the frame to the intended location.

Up to 10 Motion Detection Windows can be set. click on the "Add" button under the Live View Pane to add a Motion Detection Window. To delete a Motion Detection Window, move the mouse cursor to the selected Window, and click on the "Delete" button.

If the Motion Detection function is activated, a pop-up window (Motion) with motion indication will be shown.

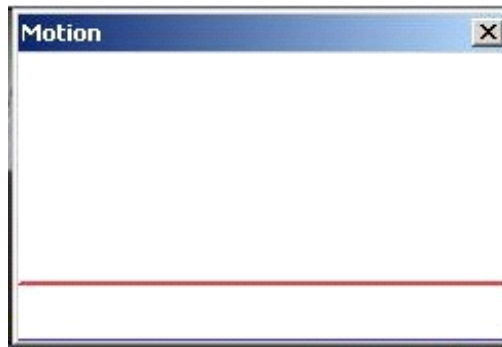

When a motion is detected, the signals will be displayed in the Motion window as shown below:

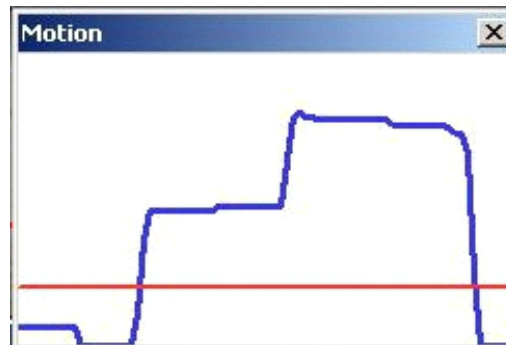

The detailed settings of Motion Detection are described as follows:

Motion Detection :

You will be able to turn the Motion Detection on/off in the System section "Motion Detection". The default setting is: Off.

Motion Detection Setting :

Users can adjust various parameters of Motion Detection in this section.

- Sampling pixel interval [1-10]:

The default value is 10, which means the system will take one sampling pixel for every 10 pixel.

- Detection level [1-100]:

The default level is 10. This item is to set the detection level for each sampling pixel; the smaller the value, the more sensitive the detection is.

Select <Upload while trigger is active> to record the triggered video until the trigger is turned off.

- Sensitivity level [1-100]:

The default level is 80, which means if 20% or more sampling pixels are detected as changing, the system will detect motion. The bigger the value, the more sensitive the detection is. Meanwhile, when the value is bigger, the red horizontal line in the motion indication window will be accordingly lower.

- Time interval (sec) [0-7200]:

The default interval is 10. This value is the interval between each detected motion.

Triggered Action (Multi-option) :

The Administrator can specify alarm actions that will take place when motion is detected. All options are listed as follows:

- Enable Alarm Output 1/2:

Check this item and select the predefined type of alarm output to enable alarm relay output when motion is detected.

- Send Message by FTP:

The Administrator can choose to send an alarm message by FTP when a motion is detected.

- Send Message by E-Mail:

The Administrator can choose to send an alarm message by E-Mail when a motion is detected.

- Upload Image by FTP:

After selecting this item, the Administrator can assign a FTP site and configure various parameters as shown in the figure below. When the alarm is triggered, event images will be uploaded to the appointed FTP site.

Upload image by FTP

FTP address: FTP1

Pre-trigger buffer: 5 frames

Post-trigger buffer: 5 frames

Continue image upload

Upload for 1 sec

Upload while trigger is active

Image frequency: Max. fps

The <Pre-trigger buffer> recording function allows users to check what happened to trigger the alarm. The pre-trigger buffer time range is from 1 to 20 frames.

On the other hand, the <Post-trigger buffer> is for uploading a certain amount of images after the alarm input is triggered. The post-trigger buffer time range is from 1 to 20 frames.

Check the box <Continue image upload> to upload the triggered images during a certain time or keep uploading until the trigger is off.

- Select <Upload for __sec> and enter the duration in the blank. The images of the duration will be uploaded via E-Mail when the alarm input is triggered. The setting range is from 1 to 9999 seconds.

- Select <Upload while trigger is active> to keep the images being uploaded via E-Mail while the trigger is active, i.e. until the alarm is stopped.

Set the Image frequency as the upload frame rate. The setting range is from 1 frame to 15 frames.

- Upload Image by E-Mail:

After selecting this item, the Administrator can assign an e-mail address and configure various parameters as shown in the picture below. When a motion is detected, event images will be sent to the appointed e-mail address.

Upload image by E-Mail

E-Mail address: E-Mail 1

Pre-trigger buffer: 5 frames

Post-trigger buffer: 5 frames

Continue image upload

Upload for 1 sec

Upload while trigger is active

Image frequency: Max. fps

The <Pre-trigger buffer> recording function allows users to check what happened to trigger the alarm. The pre-trigger buffer time range is from 1 to 20 frames.

On the other hand, the <Post-trigger buffer> is for uploading a certain amount of images after the alarm input is triggered. The post-trigger buffer time range is from 1 to 20 frames.

Check the box <Continue image upload> to upload the triggered images during a certain time or keep uploading until the trigger is off.

- Select <Upload for __sec> and enter the duration in the blank. The images of the duration will be uploaded to the FTP when the alarm input is triggered. The setting range is from 1 to 9999 seconds.

- Select <Upload while trigger is active> to keep the images being uploaded to the FTP while the trigger is active, i.e. until the alarm is stopped.

Set the Image frequency as the upload frame rate. The setting range is from 1 frame to 15 frames.

NOTE: Make sure SMTP or FTP configuration has been completed. See section 9.5. Mail and 9.6. FTP for further details.

- Send HTTP notification:

Check this item, select the destination HTTP address, and specify the parameters for event notifications when an <Alarm> is triggered. As soon as an alarm is triggered, the notification will be sent to the specified HTTP server.

For instance, if the custom parameter is set as "action=1&group=2", and the HTTP server's name is "http://192.168.1.200/admin.php", the notification will be sent to the HTTP server as "http://192.168.1.200/admin.php? Action=1&group=2" when an alarm is triggered.

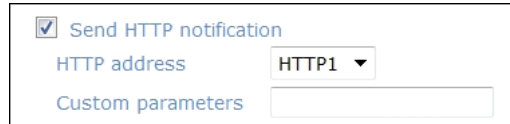

- Record Stream to SD Card:

When you select this item, the Motion Detection recording will be stored on your Micro SD/SDHC card when motion is detected.

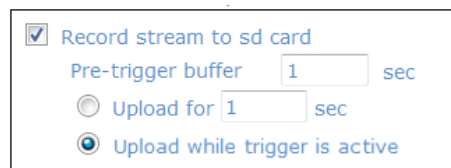

The pre-trigger buffer recording function allows users to check what happened to trigger the alarm. The pre-trigger buffer time range is from 1 to 3 seconds.

Select <Upload for __ sec> to set the recording duration after the alarm is triggered. The setting range is from 1 to 99999 seconds.

NOTE: Please make sure the local recording (with Micro SD/ SDHC card) is activated so that this function can be implemented. See section 9.14. 'Recording (on Camera)' for further details.

File Name :

The uploaded image's filename format can be set in this section. Please select the one that meets your requirements (please see the section "File Name" in 9.8. 'Application (Alarm Settings)').

Save :

Click on the "Save" button to save all the Motion Detection alarm settings mentioned above.

9.10. Network Failure Detection

The Network Failure Detection function allows the IP Camera to ping another IP device (e.g. NVR, VSS, Video Server, etc.) within the network periodically and generates some actions in case of network failure occurrence, for instance, when a Video Server is somehow disconnected.

Being capable of implementing local recording (through Micro SD card) when a network failure happens, the IP Camera can be a backup recording device for the surveillance system.

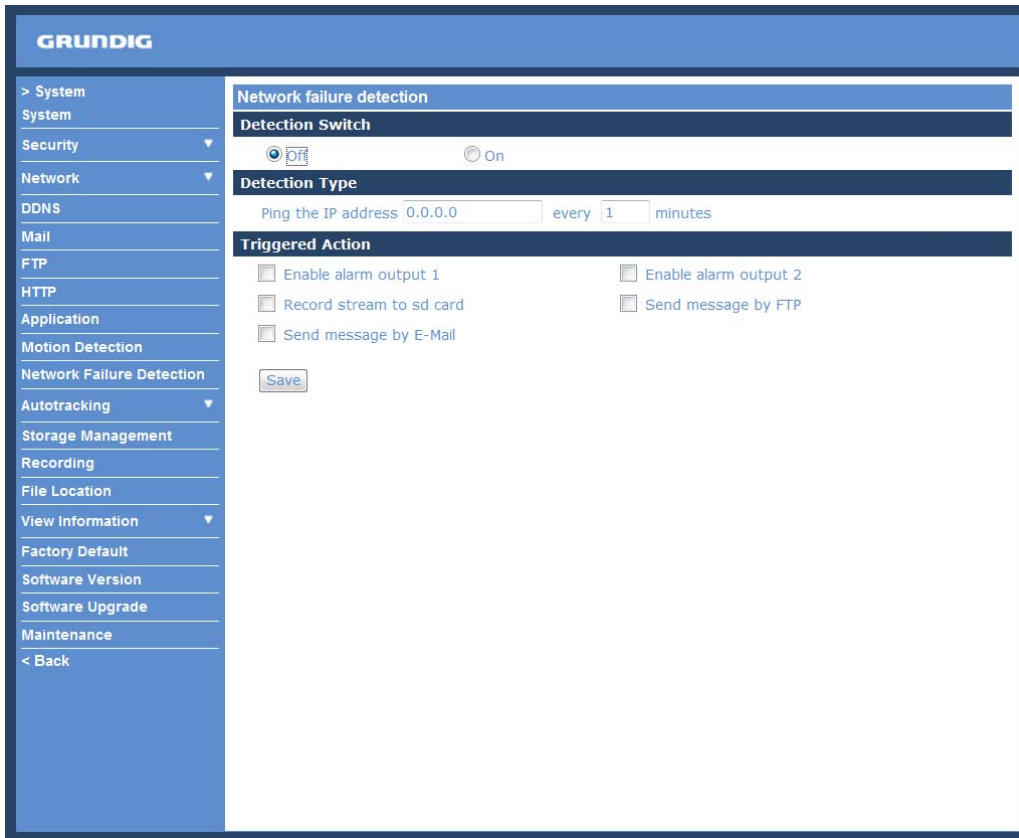

Detection Switch :

Here you can turn the Network Failure Detection on and off.

Detection Type :

Here you can set an IP address that should be pinged in order to detect network failure. Please also set the interval (in minutes) for this ping.

Triggered Action (Multi-option) :

The Administrator can specify alarm actions that will take place when Network Failure is detected. All options are listed as follows:

- Enable Alarm Output 1/2:

Check this item and select the predefined type of alarm output to enable alarm relay output when Network Failure is detected.

- Record Stream to SD Card:

When you check this item, the alarm-triggered recording will be stored on your Micro SD/SDHC card when network failure is detected.

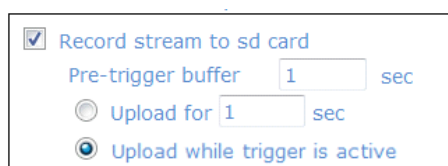

The pre-trigger buffer recording function allows users to check what happened to trigger the alarm. The pre-trigger buffer time range is from 1 to 3 seconds.

Select <Upload for ___ sec> to set the recording duration after the alarm is triggered. The setting range is from 1 to 99999 seconds.

Select <Upload while trigger is active> to record the triggered video until the trigger is turned off.

NOTE: Please make sure the local recording (with Micro SD/ SDHC card) is activated so that this function can be implemented. See section 9.14. 'Recording (on Camera)' for further details.

- Send Message by FTP:

The Administrator can select whether to send an alarm message by FTP when Network Failure is detected.

- Send Message by E-Mail:

The Administrator can choose to send an alarm message by E-Mail when Network Failure is detected.

Save :

After completing all the settings mentioned above, please click on the Save button to save all the settings in this page.

9.11. Periodical Event

The device will send the designated frame numbers to the SD card in a specified time frame/duration.

Enable this function by setting this mode to <On>.

Set the Time Interval by choosing from 60s to 3600s.

Triggered Action:

- Enable the SD card recording by ticking the box next to "Upload image to sd card".
- Pre-trigger buffer: The device will send designated frame numbers before the event (1~20 frames).
- Post-trigger buffer: The device will send designated frame numbers after the event (1~20 frames).

The screenshot displays the Grundig web interface for configuring the 'Periodical event' feature. On the left is a blue sidebar menu with the following items: > System, System, Security (with a dropdown arrow), Network (with a dropdown arrow), DDNS, Mail, FTP, HTTP, Application, Motion Detection, Network Failure Detection, Periodical event (highlighted), Autotracking (with a dropdown arrow), Storage Management, Recording, Schedule, File Location, View Information (with a dropdown arrow), Factory Default, Software Version, Software Upgrade, Maintenance, and < Back. The main content area has a blue header with the 'GRUNDIG' logo. Below the header, the 'Periodical event' configuration is shown. It includes a 'Periodical event' section with radio buttons for 'Off' (selected) and 'On'. Below that is the 'Time interval' section with a 'Minimum interval' input field set to '60' and the unit 'sec'. The 'Triggered Action' section contains a checkbox for 'Upload image to sd card' which is unchecked, and two dropdown menus for 'Pre-trigger buffer' and 'Post-trigger buffer', both set to '5 frames'. A 'Save' button is located at the bottom of the configuration area.

9.12. Autotracking

The Autotracking function is only for the models GCI-K0779P and GCI-K1779P. This function will only become available after authentication is done. For more information about authenticating the function, please see the Insert Key section below.

The Autotracking function will automatically detect a moving object in the preset area and follow it according to the defined settings. Please find the function setting in the following path: System > Autotracking.

By clicking on the category <Autotracking>, the <Autotracking> and <Insert Key> tabs will be shown in the drop-down menu. Enter the setting menu by clicking on the <Autotracking> tab.

<Autotracking> :

The default setting of the Autotracking function is <Off>. Select <On> to enable this function.

NOTE: The setting items will be available after <On> is selected.

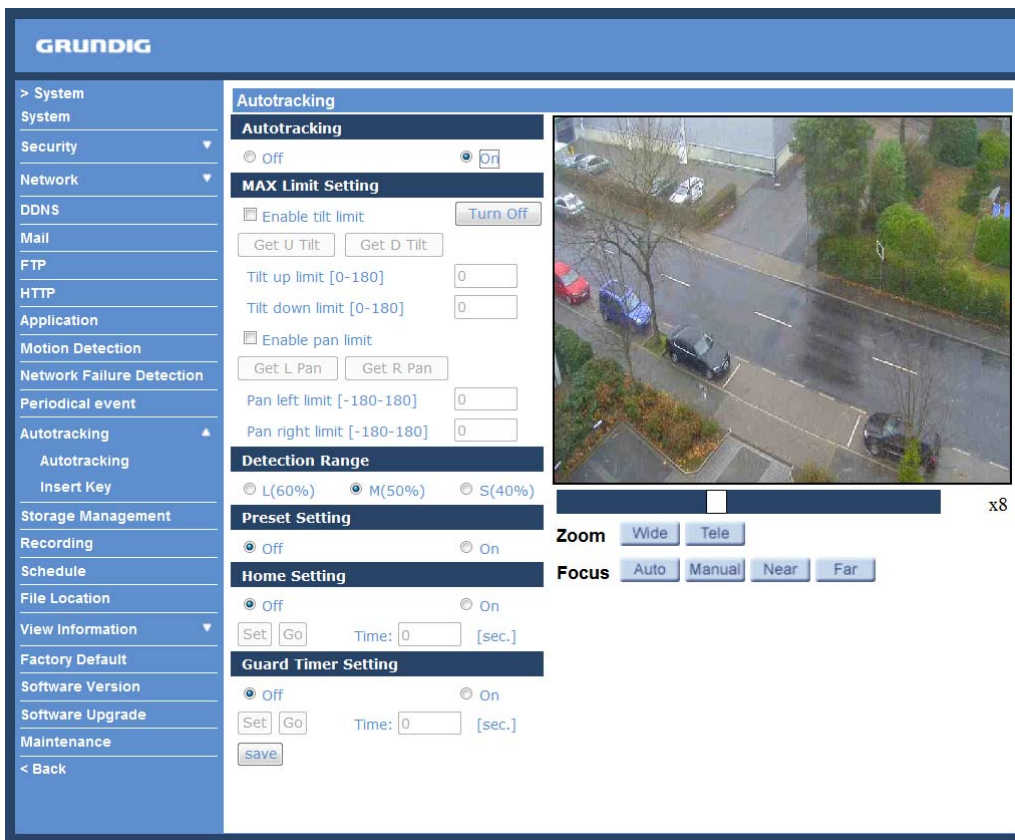

MAX Limit Setting :

This setting menu allows the users to define a tracking area for the detection and tracking of movement of the camera.

- Turn Off:

To avoid the setting process being disturbed by the camera's tracking movement, please click on the <Turn Off> button to switch off the tracking function.

NOTE: The Autotracking function needs to be reactivated to take effect after saving all the necessary settings. Please follow the steps below.

- Select <Off> under <Autotracking> at the top.
- Click on the <Save> button for confirmation.
- Select <On> under <Autotracking> at the top.
- Click on the <Save> button to confirm the settings.

- Enable tilt limit:

Tick the box to enable the tilt limit setting.

- Get U Tilt / D Tilt:

Please click and drag the PTZ pointer in the view window to the desired up or down tilt position. Then click on the <Get U Tilt> / <Get D Tilt> button to get the boundary values.

- Enable pan limit:

Tick the box to enable the pan limit setting.

- Get L Pan / R Pan:

Please click and drag the PTZ pointer in the view window to the desired left or right pan position. Then click on the <Get L Pan> / <Get R Pan> button to get the boundary values.

Detection Range :

Detection range can be set to detect motions around the centre of the view window. Please choose a value to define the detection area (in percentage) around the centre point. The available options are <L(60%)>, <M(50%)> and <S(40%)>.

Preset Setting :

In this setting menu, the Autotracking function and its related functions can be activated for the first 10 preset points of each sequence line.

NOTE: When <Preset Setting> is activated, the <Home Setting> and the <Guard Timer Setting> will be unavailable.

- Off / On:

The default setting of the Preset Setting is <Off>. Select <On> to enable the function.

- Sequence line:

Select a desired sequence line from the drop-down menu to set its Autotracking function.

- Preset:

Select a desired preset point from the drop-down menu to set its Autotracking function.

Please use the <Autotracking> drop-down menu underneath to turn on / off the tracking function for each chosen preset point.

- Ratio:

Zoom ratio can be set for the camera to automatically zoom in / out when it is tracking a moving object. Please type in the ratio number in the blank space.

- Guard Time:

Guard time is for defining the maximum tracking time of the camera for each chosen preset point. Please enter the time in seconds (range from 0~999) in the blank space. Click on the <Set> button on the right to finish setting up a preset point.

NOTE: Repeat the steps from <Sequence line> to <Guard Time> for setting other preset points.

Home Setting :

This function allows users to set the main monitoring area as the home position for the camera. In addition, maximum time can also be set for defining the time for the camera to keep watching a stopped tracking object. The camera will return to the home position according to the defined time setting.

NOTE: <Preset Setting> must be <Off> in order to configure the <Home Setting> function.

- Off / On:

The default setting of Home Setting is <Off>. Select <On> to enable the function.

- Home Position:

To set the home position, please click and drag the PTZ pointer in the view window to the desired position. Click on <Set> to confirm the position.

- Time:

Please type in the time that the camera should keep watching a stopped tracking object. The camera will return to the home position after the defined time period.

- Go:

Click on <Go> to move the camera to the home position.

Guard Timer Setting :

This function allows users to set the main monitoring area as the guard position, and set the duration of time for the camera to track an object.

NOTE: <Preset Setting> must be <Off> in order to configure the <Guard Timer Setting> function.

- Off / On:

The default setting of the Guard Timer Setting is <Off>. Select <On> to enable the function.

- Guard Position:

To set the guard position, please click and drag the PTZ pointer in the view window to the desired position. Click on <Set> to confirm the position.

- Time:

Please type in the duration of time that the camera should track a moving object.

- Go:

Click on <Go> to move the camera to the guard position.

Save :

Click on <Save> to confirm the settings.

<Insert Key> :

If the Autotracking function is already available, users do not need to type in any product key in this page. However, if it is not, please contact the system installers or the sales representatives for the product key. Authentication can be done by typing in the product key in the blank space provided in the Insert Key page and by clicking on <OK> to enable the function.

It also possible to obtain a testing license for 30 days. Please contact your system installers or the sales representatives for further information.

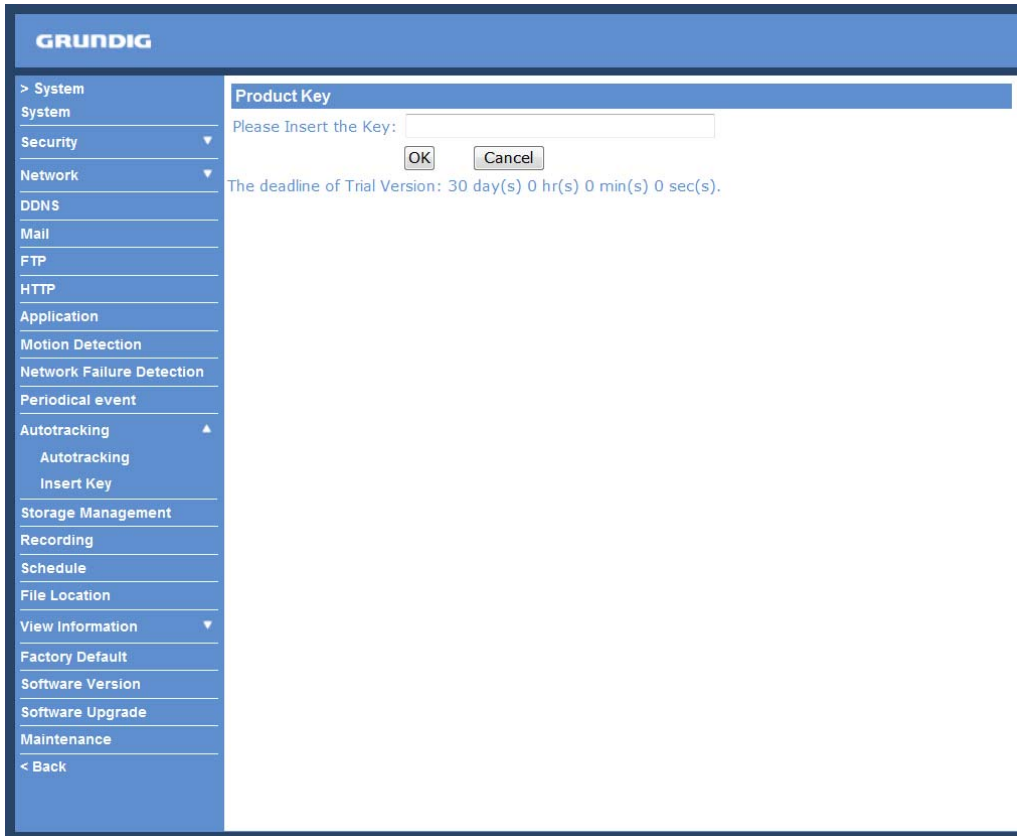

9.13. Storage Management (on Camera)

Users can store local recordings on a Micro SD/SDHC card of up to 32 GB. This page shows the capacity information of the Micro SD card and a recording list with all the recording files saved on the memory card. Users can also format the SD card and implement automatic recording cleanup through the setting page.

To implement Micro SD card recording, please go to the "Recording" page (see 9.14. 'Recording (on Camera)') for activation.

NOTE: Please format the Micro SD/SDHC card when using it for the first time. Formatting will also be required when a memory card has already been used on one device and was later transferred to another device with a different software platform.

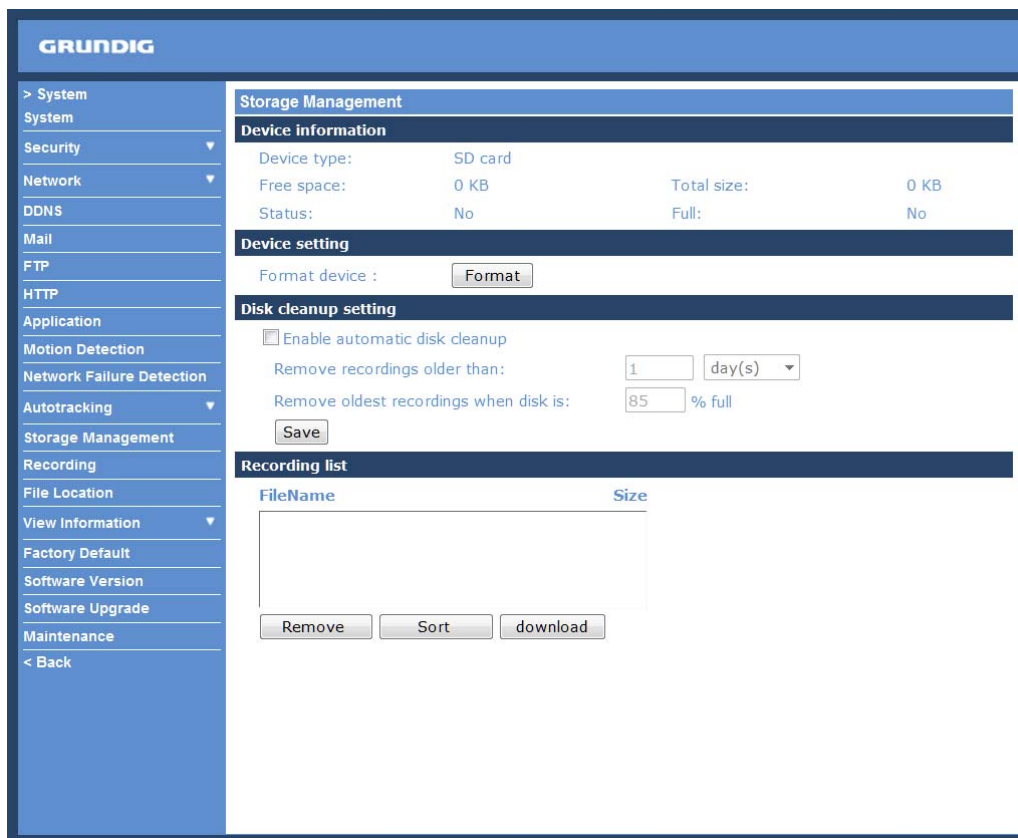

Device Information :

When users insert the Micro SD/SDHC card, the card information such as the memory capacity and status will be shown in the Device Information section. The memory card is successfully installed if its status is shown in the "Device information" section in the Storage Management page.

Device Setting :

Click on the "Format" button to format the memory card.

Disk Cleanup Setting :

Users can enable an automatic recordings cleanup by checking this item and specifying the time and storage limits.

Recording List :

Each video file on the Micro SD/SDHC card will be listed in the Recording list as shown below. The maximum file size is 60 MB (60 MB per file).

If the recording modus is set to "Always" and at the same time the event recording (when a motion detection or an alarm takes place) is also turned on, in this case, when an event occurs, the event will be recorded first, afterwards the camera will return to normal recording mode.

When the recording mode is set to "Always" (consecutive recording) in the submenu "Recording" and the Micro SD/SDHC card recording is also allowed to be enabled when triggered by events, once the events occur, the system will immediately implement the recorded events to the memory card. After event recording, the device will return to regular recording mode.

| Recording list | |
|-----------------------|---------|
| FileName | Size |
| M_20110325_175641.avi | 1114 K |
| M_20110325_175800.avi | 14855 K |
| M_20110325_175824.avi | 9901 K |
| M_20110325_180018.avi | 16938 K |
| M_20110325_180047.avi | 16904 K |

Remove Sort Download

- Remove:

To remove a file, select the file first, and then click on the "Remove" button.

- Sort:

When you click on the "Sort" button, the files in the Recording list will be listed in name and date order.

NOTE: The capital letters (A, M or R) appearing in the very beginning of a name denote the sort of the recording: A stands for Alarm, M stands for Motion and R stands for regular recording.

- Download:

To open/download a video clip, select the file first, and then click on the "Download" button underneath the Recording list field. The selected file window will pop up as shown below. Click on the AVI file to directly play the video in the player or download it to a specified location.

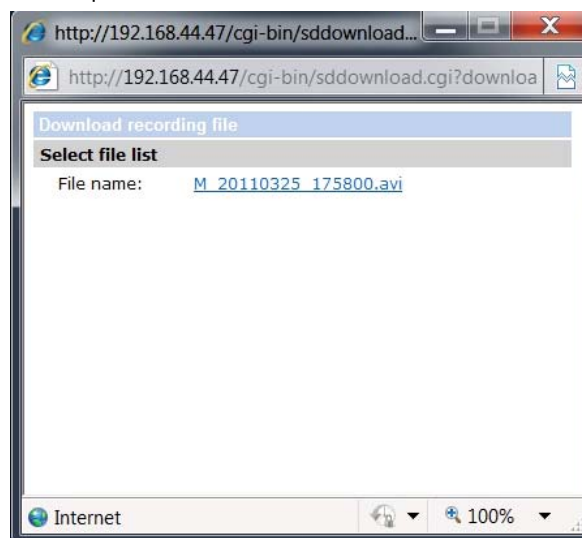

9.14. Recording (on Camera)

In the Recording setting page, the Micro SD Card recording schedule supports up to ten sets of time frames. Users can specify the recording schedule to fit their present surveillance requirements.

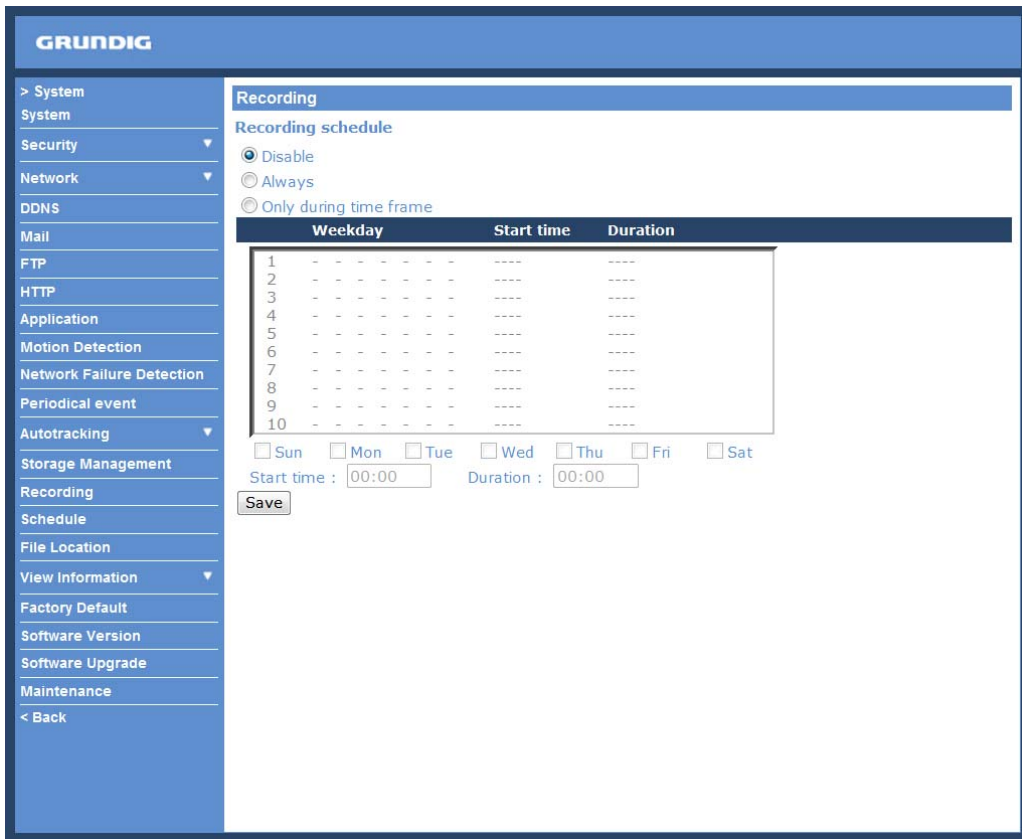

Activating Micro SD/SDHC Card Recording :

Two types of schedule mode are offered: "Always" and "Only during time frame". You can set up the time frame according to your requirements or you can choose "Always" to allow the Micro SD/SDHC Card Recording to be activated all the time. Or select a set of schedules from the time frame blank, check specific weekdays and set up the start time (hour:minute) and time period (hour:minute) to activate the Micro SD/SDHC Card Recording in certain time frames. The setting range for the time period hour is from 0 to 168.

Please click on the "Save" button to confirm the schedule mode.

Terminating Micro SD/SDHC Card Recording :

Select "Disable" to terminate the recording function.

9.15. Schedule

This function allows the users to setup schedules for features including: <Alarm Switch>, <Motion Detection> and <Network Failure Detection>. The function supports up to 10 sets of time frames in the time frame list.

Setting a schedule:

To set a schedule, please select a time frame from the time frame list first. Then check the boxes at the bottom of the time frame to choose the specific weekdays. At last, type in the start time (hour:minute) and the duration time (hour:minute) for activation of the schedule triggered features. The setting range for the duration time is from 00:00 to 168:59.

Click <Delete> to delete a chosen time frame.

Please click on <Save> to save the setup.

NOTE: Users MUST select <By schedule> under each feature setting page to enable the schedule function.

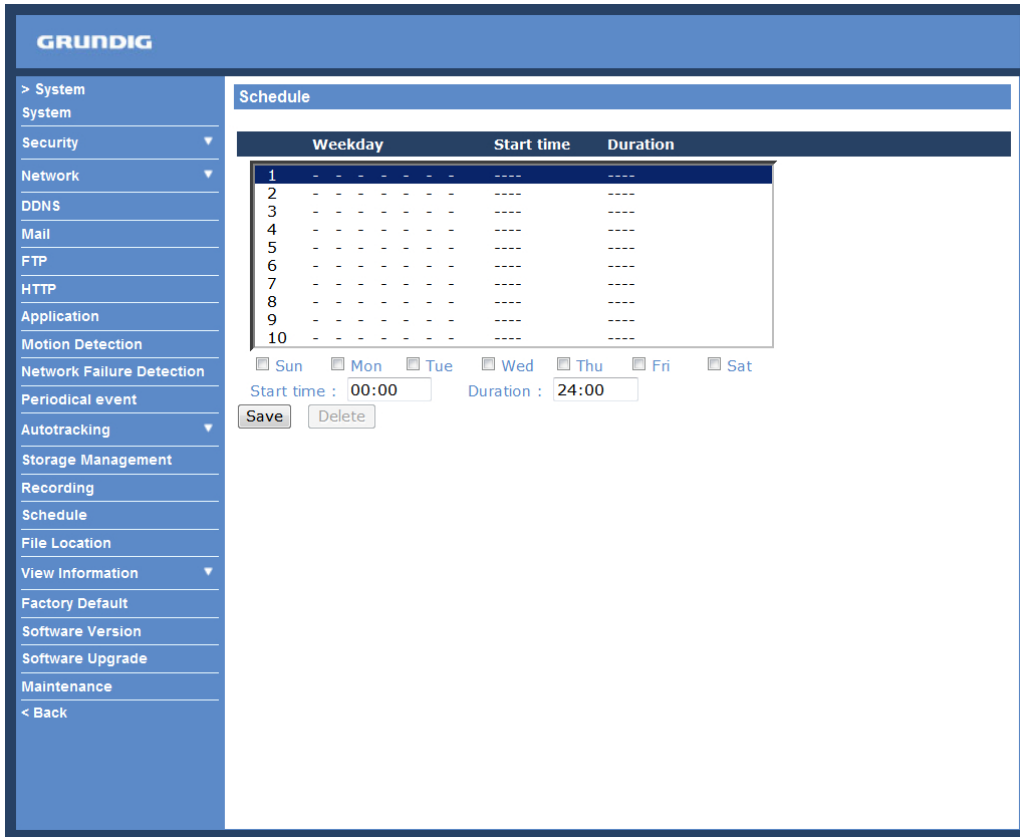

9.16. File Location (on PC)

Users can specify a storage location for the snapshots and the live video recording. The default setting is: C:\. Once the setting is confirmed, click on "Save," and all the snapshots and recordings will be saved in the designated location.

NOTE: Please make sure the selected file path contains valid characters such as letters and numbers.

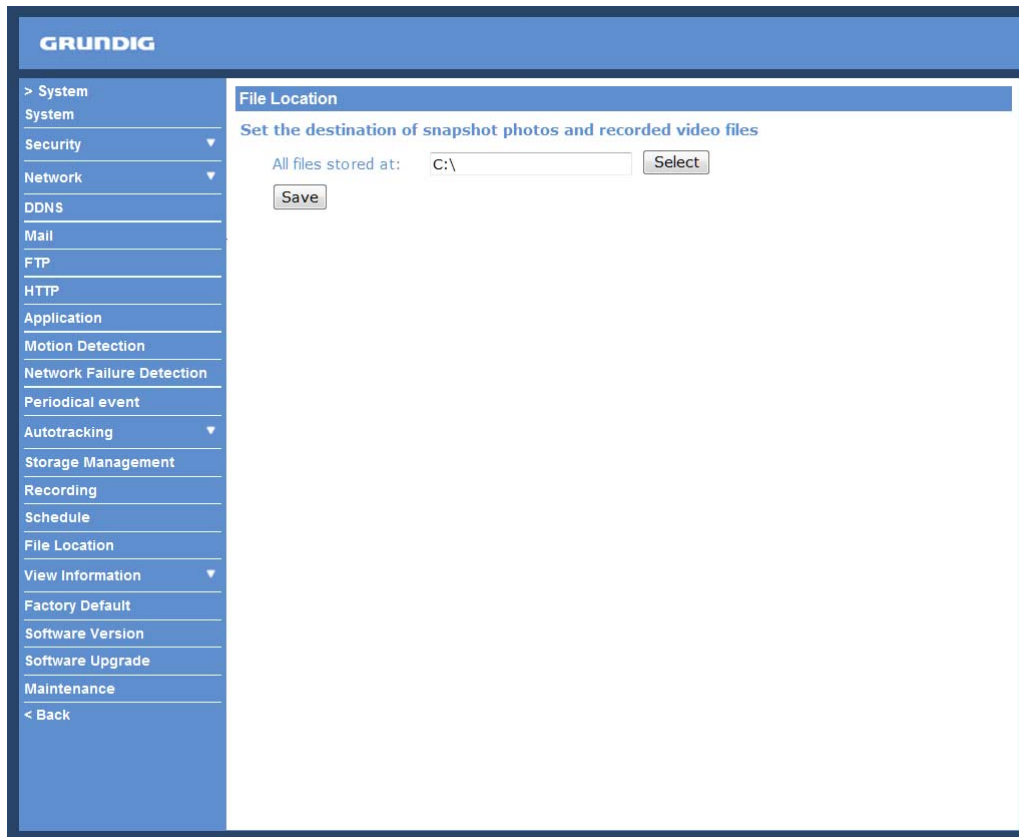

NOTE: Users with the Windows 7 operating system on their PC need to follow the following procedure to be able to use the Snapshot function. First you need to log on to your computer as an Administrator. Then please go to Windows Start menu, click with the right mouse button on your Internet Browser and select in the appearing pop-up window "Run as Administrator". Afterwards you can log in to your camera as usual (as an administrator or user).

9.17. View Information

<Log File>:

Click on the link to view the system log file. The content of this file provides useful information about configuration and connections after system boot-up.

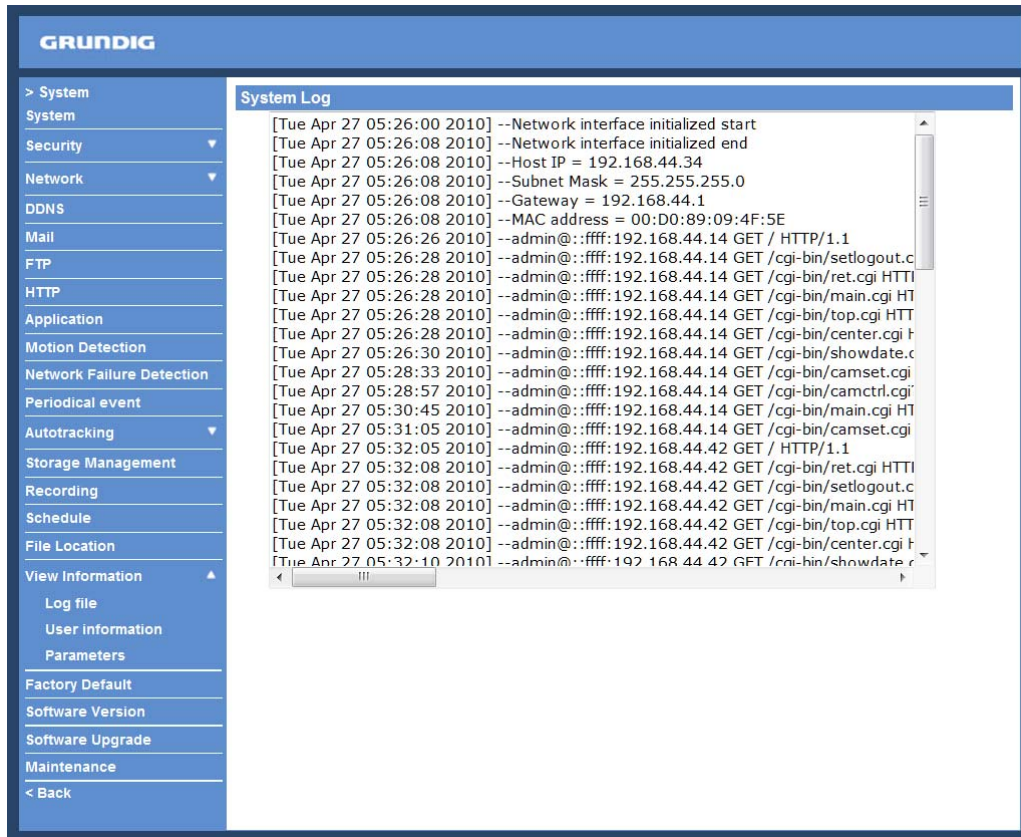

The screenshot displays the GRUNDIG web interface. On the left is a navigation menu with the following items: > System, System, Security, Network, DDNS, Mail, FTP, HTTP, Application, Motion Detection, Network Failure Detection, Periodical event, Autotracking, Storage Management, Recording, Schedule, File Location, View Information (expanded to show Log file, User information, Parameters), Factory Default, Software Version, Software Upgrade, Maintenance, and < Back. The main content area is titled 'System Log' and contains a scrollable list of log entries. The entries are timestamped and include details about network initialization and subsequent HTTP requests from an administrator.

```
[Tue Apr 27 05:26:00 2010] --Network interface initialized start
[Tue Apr 27 05:26:08 2010] --Network interface initialized end
[Tue Apr 27 05:26:08 2010] --Host IP = 192.168.44.34
[Tue Apr 27 05:26:08 2010] --Subnet Mask = 255.255.255.0
[Tue Apr 27 05:26:08 2010] --Gateway = 192.168.44.1
[Tue Apr 27 05:26:08 2010] --MAC address = 00:D0:89:09:4F:5E
[Tue Apr 27 05:26:26 2010] --admin@:ffff:192.168.44.14 GET / HTTP/1.1
[Tue Apr 27 05:26:28 2010] --admin@:ffff:192.168.44.14 GET /cgi-bin/setlogout.c
[Tue Apr 27 05:26:28 2010] --admin@:ffff:192.168.44.14 GET /cgi-bin/ret.cgi HTTP
[Tue Apr 27 05:26:28 2010] --admin@:ffff:192.168.44.14 GET /cgi-bin/main.cgi HT
[Tue Apr 27 05:26:28 2010] --admin@:ffff:192.168.44.14 GET /cgi-bin/top.cgi HTT
[Tue Apr 27 05:26:28 2010] --admin@:ffff:192.168.44.14 GET /cgi-bin/center.cgi t
[Tue Apr 27 05:26:30 2010] --admin@:ffff:192.168.44.14 GET /cgi-bin/showdate.c
[Tue Apr 27 05:28:33 2010] --admin@:ffff:192.168.44.14 GET /cgi-bin/camset.cgi
[Tue Apr 27 05:28:57 2010] --admin@:ffff:192.168.44.14 GET /cgi-bin/camctrl.cgi
[Tue Apr 27 05:30:45 2010] --admin@:ffff:192.168.44.14 GET /cgi-bin/main.cgi HT
[Tue Apr 27 05:31:05 2010] --admin@:ffff:192.168.44.14 GET /cgi-bin/camset.cgi
[Tue Apr 27 05:32:05 2010] --admin@:ffff:192.168.44.42 GET / HTTP/1.1
[Tue Apr 27 05:32:08 2010] --admin@:ffff:192.168.44.42 GET /cgi-bin/ret.cgi HTTP
[Tue Apr 27 05:32:08 2010] --admin@:ffff:192.168.44.42 GET /cgi-bin/setlogout.c
[Tue Apr 27 05:32:08 2010] --admin@:ffff:192.168.44.42 GET /cgi-bin/main.cgi HT
[Tue Apr 27 05:32:08 2010] --admin@:ffff:192.168.44.42 GET /cgi-bin/top.cgi HTT
[Tue Apr 27 05:32:08 2010] --admin@:ffff:192.168.44.42 GET /cgi-bin/center.cgi t
[Tue Apr 27 05:32:10 2010] --admin@:ffff:192.168.44.42 GET /cgi-bin/showdate.c
```

<User Information>:

The Administrator can view each user's login information and their privileges (see section 9.2. Security).

View User Login Information :

All the users in the network will be listed in the "User Information" zone, as shown below. The picture below shows: User: 4321

This indicates that one user's login username is: User, and the password is: 4321

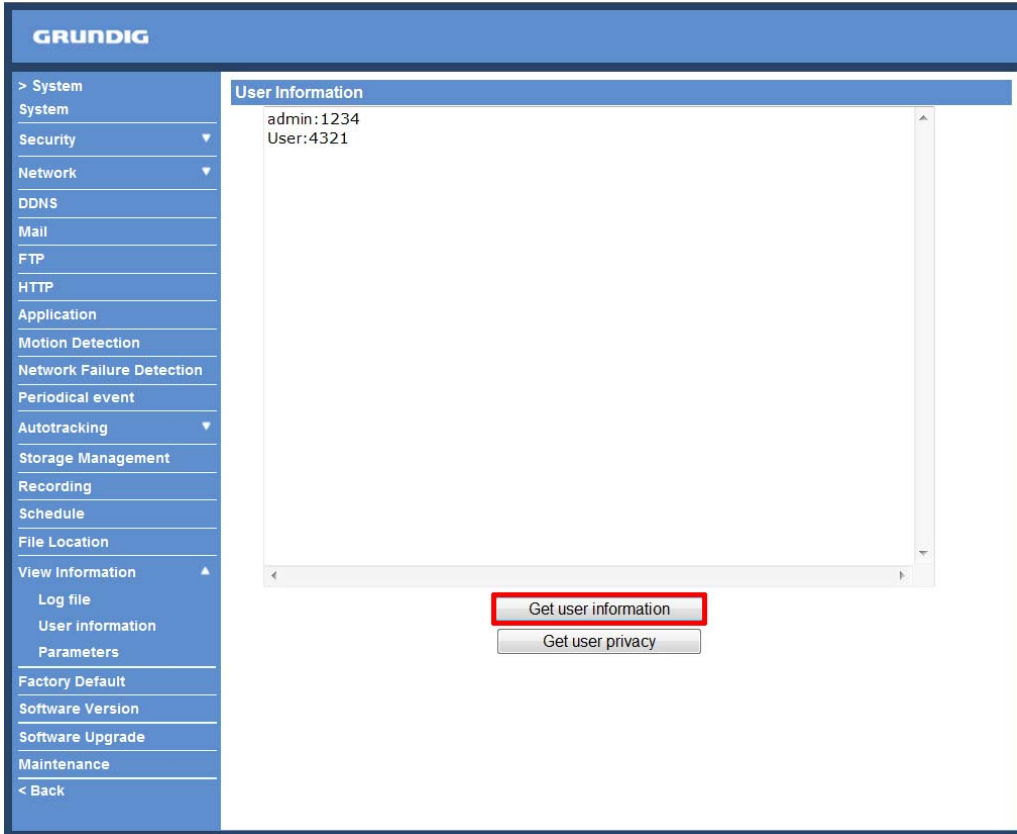

View User Privilege :

If you click on "Get user privacy" at the bottom of the page, the Administrator will be able to view each user's privileges.

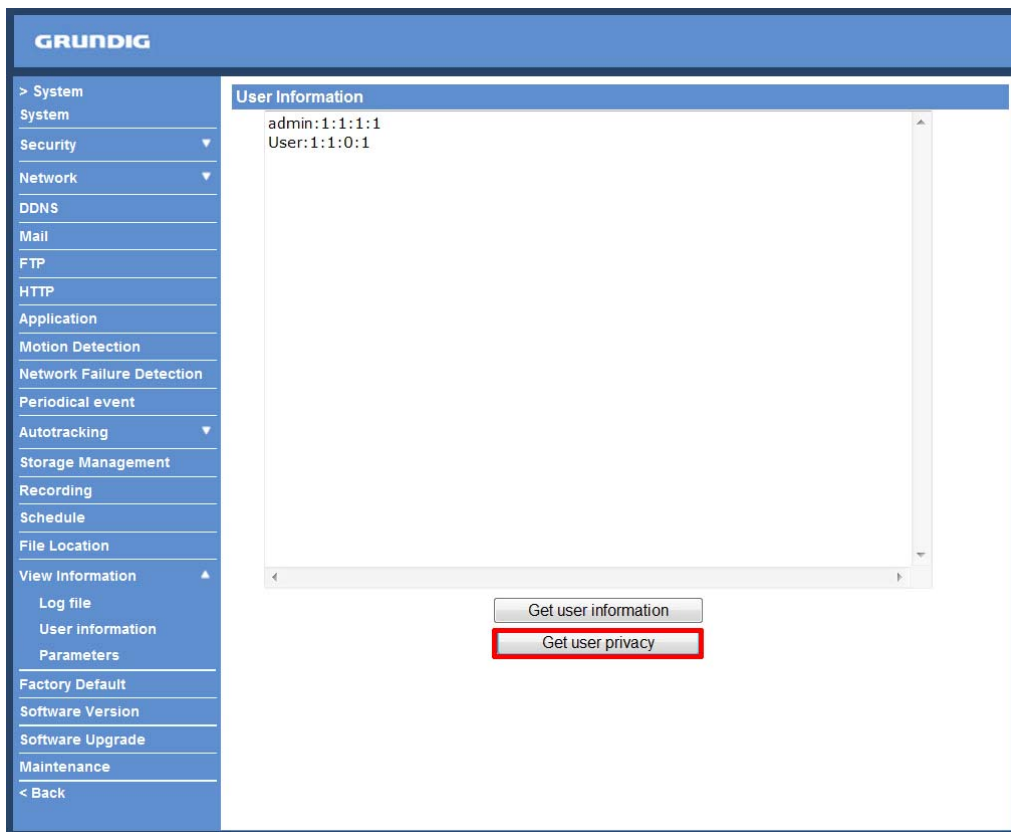

As the picture above shows: User: 1:1:0:1

1:1:0:1 = I/O access : Camera control : Talk : Listen (see 9.2. Security)

This denotes that the user has been granted the privileges of I/O access, Camera control and Listen.



<Parameters>:

Click on this item to view the entire system's parameter setting.

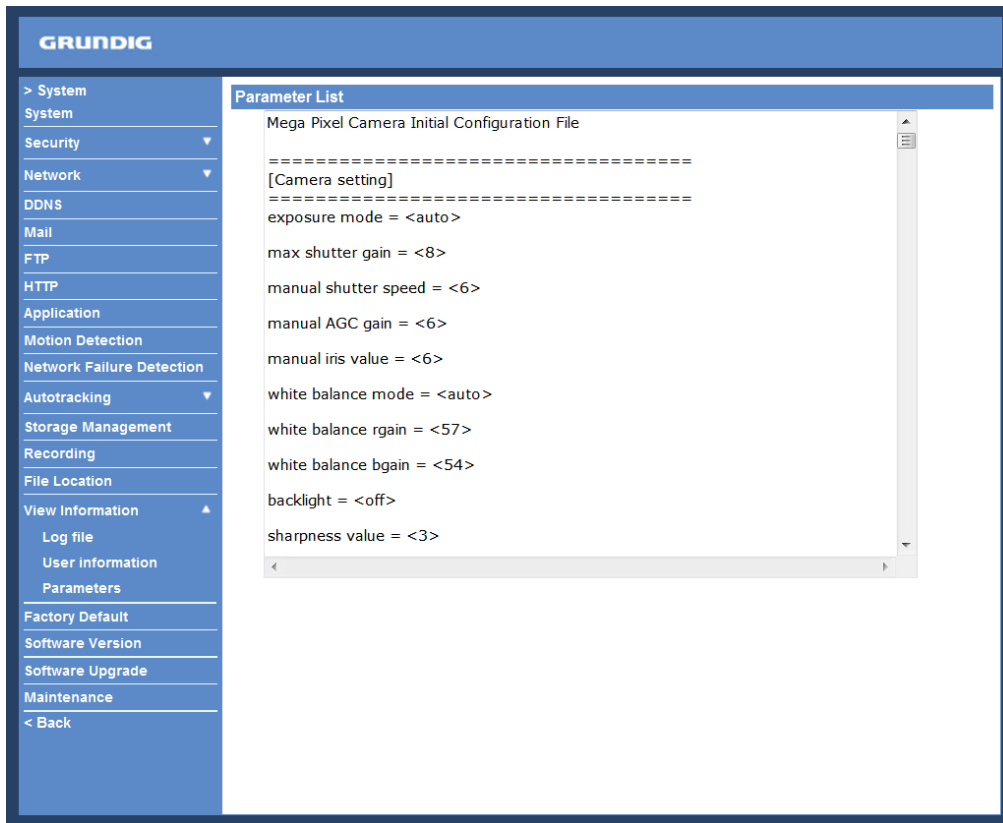

9.18. Factory Default

The factory default setting page is shown below. Follow the instructions to reset the IP Camera to factory default setting if needed.

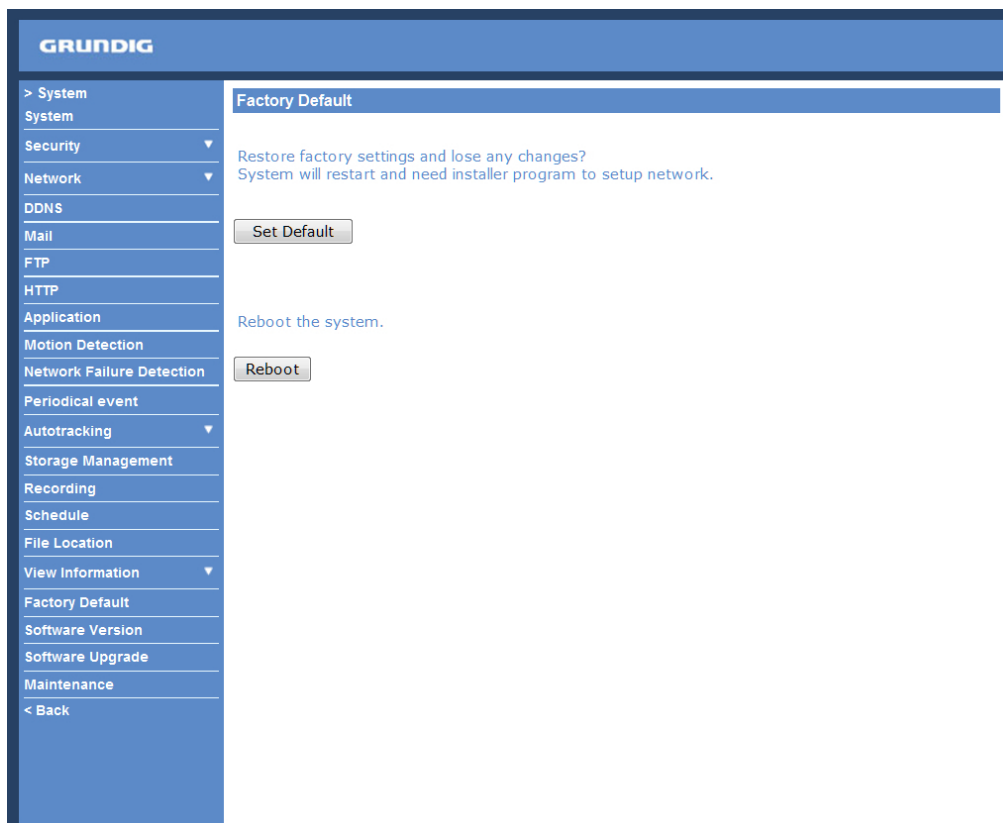

Full Restore :

Click on the “Full Restore” button to recall the factory default settings. After 30 seconds the system will restart.

Partial Restore :

Click on the “Partial Restore” button to recall the factory default settings, except for the network settings.

NOTE: The IP address will also be restored to default (192.168.1.1).

Reboot :

When you click on the “Reboot” button, the system will restart without changing the current settings.

9.19. Software Version

The current software version is displayed in the software version page, which is shown in the picture below.

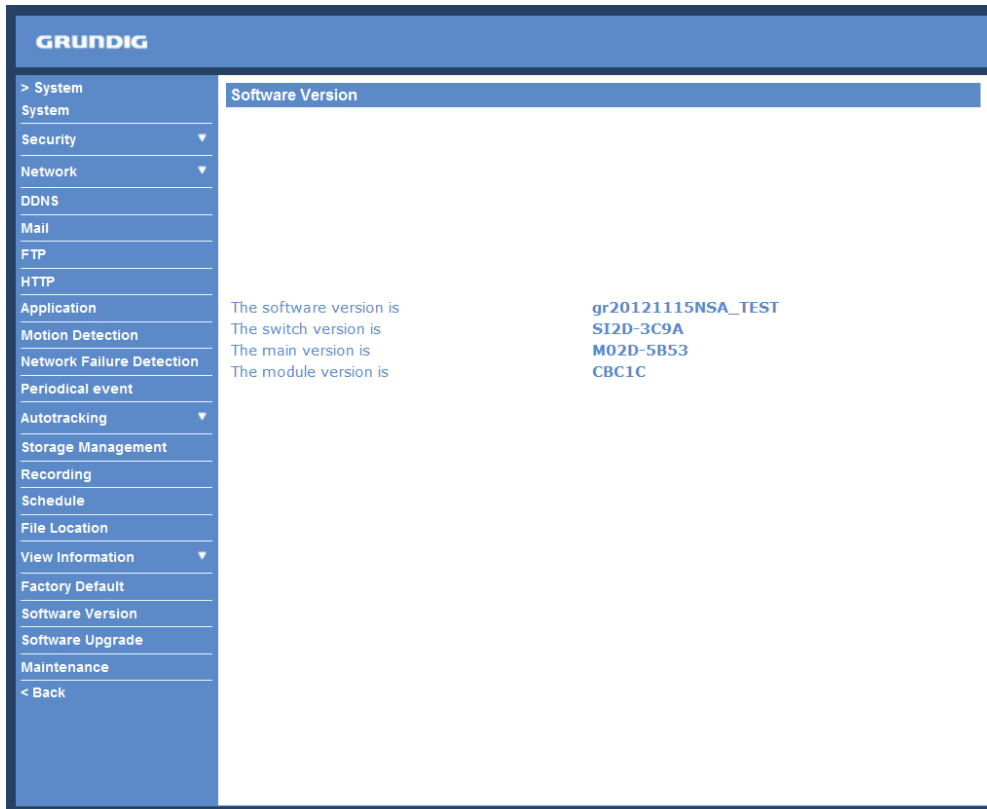

9.20. Software Upgrade

Software upgrade can be carried out on the “Software Upgrade” page, as shown below.

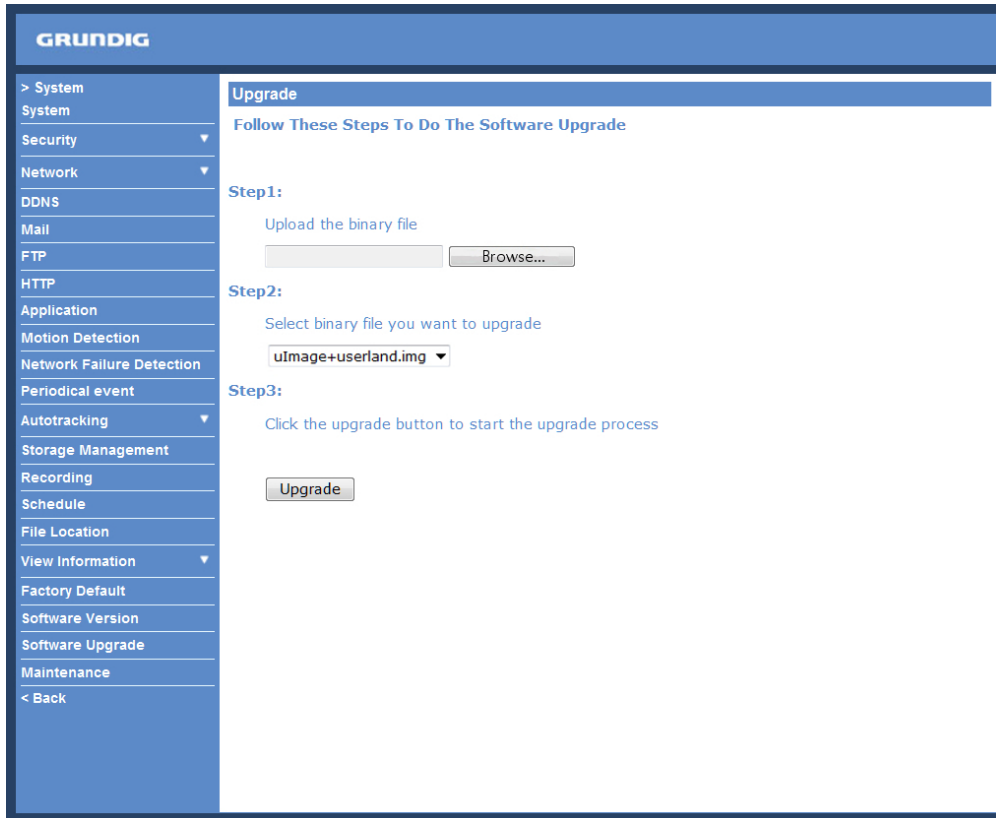

NOTE: Make sure the upgrade software file is available before carrying out the software upgrade.

The procedure of a software upgrade is as follows:

Step 1: Click on “Browse” and select the following binary file to be uploaded: ulmage+userland.

NOTE: Do not change the upgrade file name, or the system will fail to find the file.

Step 2: Pull down the upgrade binary file list and select the file you want to upgrade; in this case, select “ulmage+userland”.

Step 3: Click on “Upgrade”. The system will first check whether the upgrade file exists or not, and then begin to upload the upgrade file. Subsequently, the upgrade status bar will be displayed on the page. When 100% is reached, the upgrade process is finished.

After the upgrade process is finished, the Viewer will return to the Home page.

Step 4: Close the video browser.

Step 5: Go to “Start” on your Windows desktop, activate “Control Panel”, and then double-click on “Add or Remove Programs”. In the “Currently installed programs” list, select “GRUNDIG Viewer” and click on the button “Remove” to uninstall the existing GRUNDIG Viewer.

Step 6: Open a new web browser, re-login the IP Camera, and then allow the automatic download of the GRUNDIG Viewer.

9.21. Maintenance

Users can export configuration files to a specified location and retrieve data by uploading an existing configuration file to the IP Camera. This is especially convenient if you want to have the same configuration for multiple cameras.

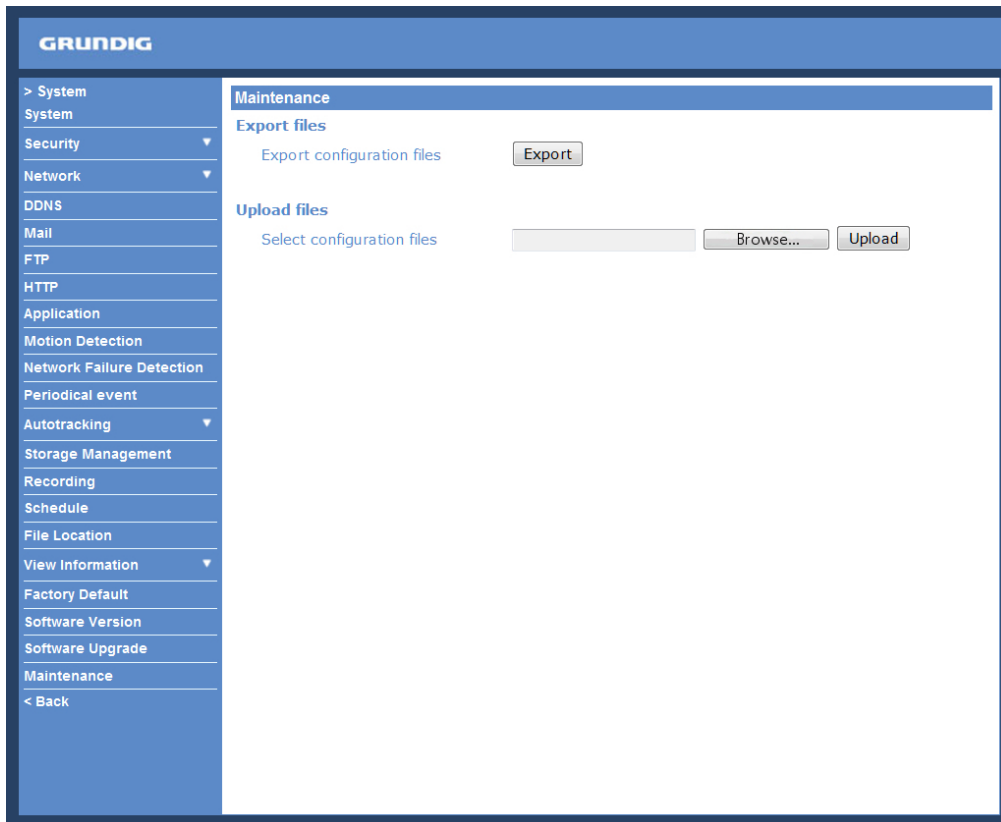

Export:

Users can save the system settings by exporting the configuration file (.bin) to a specified location for future use. When you click on the “Export” button, the File Download window will pop up as shown below. Click “Save” and specify a desired location for saving the configuration file.



Upload:

To copy an existing configuration file to the IP Camera, please first click on “Browse” to select the configuration file, and then click on the “Upload” button for uploading.

NOTE: The cameras need to have the same software version to upload the configuration file.

10. Streaming Settings

10.1. Video Format

Video Resolution :

Under the Video Resolution section, the available video resolution formats include MJPEG and H.264. Please refer to Chapter 6. Video Resolution Setup for combination details.

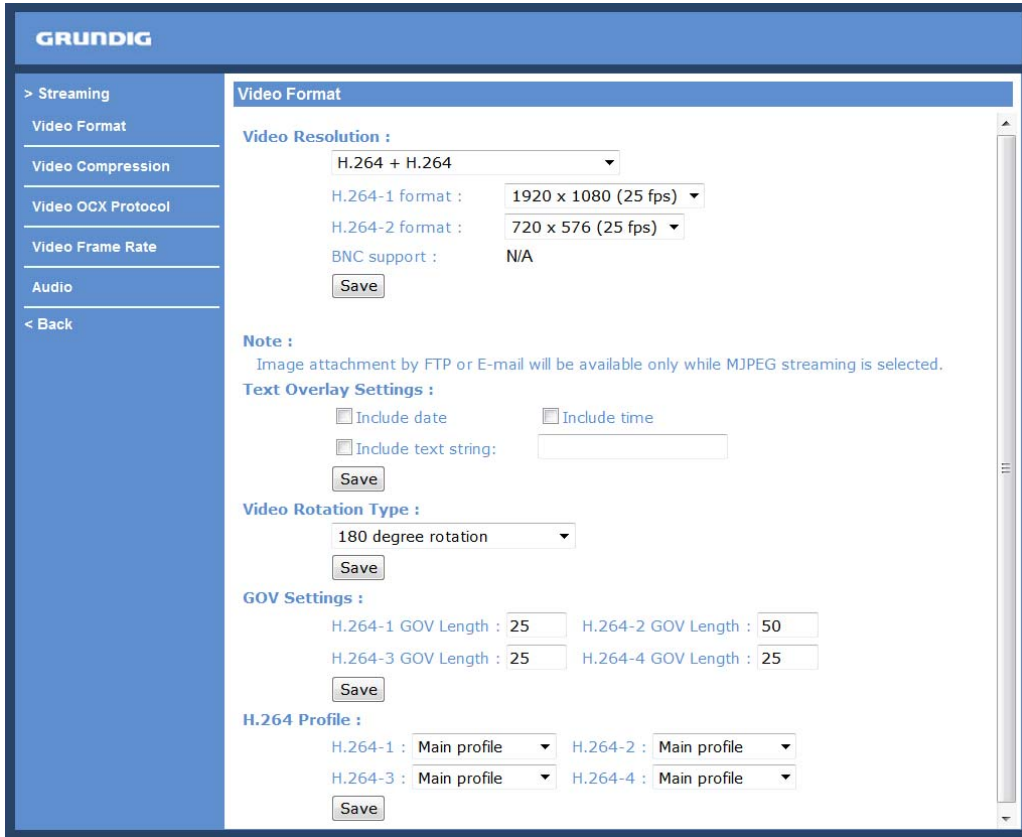

Click on “Save” to confirm the setting.

Text Overlay Settings :

Users can select these items to display data (date/time/text) on the live video pane. The maximum length of the string is 18 alphanumeric characters.

Click “Save” to confirm the Text Overlay setting.

Video Rotation Type :

Users can change the video display type if necessary. The selectable video rotation types include Normal video, Flip video, Mirror video, 90 degree counter-/clockwise and 180 degree rotation. Differences between these types are illustrated below.

Suppose the displayed image of IP Camera is shown as the figure below.



To rotate the image, users can select “Flip video”, for instance. Then the displayed image will be reversed as shown below.



The following are descriptions of different video rotation types.

- Flip video:

If you select <Flip video>, the image will be rotated horizontally.

- Mirror video:

If you select <Mirror video>, the image will be rotated vertically.

- 90 degree counter-/clockwise:

Selecting <90 degree counter-/clockwise> will inverse the image 90° counter-/clockwise. The image will only be shown with the right proportions in "Fullscreen View". Click on the Fullscreen Button (third button from the left) on the main page to enlarge the image and double-click to go back to "Normal View".

- 180 degree rotation:

Selecting the <180 degree rotation> will inverse the image 180° counter-/clockwise.

Click “Save” to confirm the setting.

GOV Settings :

Users can set the GOV length to determine the frame structure (I-frames and P-frames) in a video stream for saving bandwidth. Longer GOV means decreasing the frequency of I-frames. The setting range for the GOV length is from 2 to 64. The default setting of GOV is 60 which means there is one I-frame every 60 seconds. The default value for H.264-1/ H.264-2/ H.264-3/ H.264-4 is 60/ 60/ 30/ 30.

Click “Save” to confirm the GOV setting.

This camera provides three H.264 streaming formats to meet the requirements from viewing devices, the surveillance system, and the network condition of the application and installation environment. Users can set each H.264 Profile to <Baseline Profile>, <Main Profile> or <High Profile> according to the compression needs. With the same bit rate, the higher the compression ratio, the better the image quality is. The default setting is <Main Profile>.

H.264 Baseline profile: Standard Efficiency Encoding Format

H.264 Main profile: Good Efficiency Encoding Format

H.264 High profile: High Efficiency Encoding Format

10.2. Video Compression

Users can specify the values for MJPEG/H.264 compression mode in the video compression page (see the picture below), depending on the application.

MJPEG compression setting (MJPEG Q (Quality) factor):

A higher value implies higher bit rates and a higher visual quality. The default setting is 35; the setting range is from 1 to 70.

Click "Save" to confirm the setting.

H.264-1 / H.264-2 / H.264-3 / H.264-4 bit rate:

The default setting of H.264-1 is 4096 kbps and of H.264-2/H.264-3/H.264-4 is 1024 kbps. The setting range for H.264-1 is from 64 to 8192 kbps and for H.264-2/H.264-3/H.264-4 it is from 64 to 2048 kbps.

Click "Save" to confirm the setting.

The screenshot shows the Grundig Video Compression settings page. The left sidebar contains navigation options: Streaming, Video Format, Video Compression (selected), Video OCX Protocol, Video Frame Rate, Audio, and Back. The main content area is titled 'Video Compression' and includes the following sections:

- MJPEG Compression setting :** MJPEG Q factor : 35 [Save]
- H.264-1 Compression setting :** H264-1 bit rate : 4096 kbit/s [Save]
- H.264-2 Compression setting :** H264-2 bit rate : 1024 kbit/s [Save]
- H.264-3 Compression setting :** H264-3 bit rate : 1024 kbit/s [Save]
- H.264-4 Compression setting :** H264-4 bit rate : 1024 kbit/s [Save]
- Compression information setting :** Display compression information in the home page [Save]
- CBR mode setting :** enable H.264-1 CBR mode, enable H.264-2 CBR mode, enable H.264-3 CBR mode, enable H.264-4 CBR mode [Save]

Compression information setting :

Users can also decide whether to display compression information on the Home page.

Click "Save" to confirm the setting.

CBR mode setting :

The CBR (Constant Bit Rate) mode can become the preferred bit rate mode if the available bandwidth is limited. It is important to take into account the image quality when you choose to use CBR mode.

Click on "Save" to confirm the setting.

10.3. Video OCX Protocol

In the Video OCX protocol setting page, users can select RTP over UDP, RTP over TCP, RTSP over HTTP or MJPEG over HTTP, for streaming media over the network. In the case of multicast networking, users can select the Multicast mode. The Video OCX Protocol page is as follows:

Video OCX protocol setting options include:

- RTP over UDP / RTP over RTSP (TCP) / RTSP over HTTP / MJPEG over HTTP
(Select a mode according to your data delivery requirements.)

- Multicast Mode:

Enter all required data, including multicast IP address, H.264 video port, MJPEG video port, audio port and TTL into each blank.

Click on “Save” to confirm the setting.

10.4. Video Frame Rate

Video frame skipping is for saving bandwidth if necessary. The setting page is shown below.

The screenshot shows the Grundig web interface for video frame rate settings. On the left is a blue sidebar with a menu: > Streaming, Video Format, Video Compression, Video OCX Protocol, Video Frame Rate (highlighted), Audio, and < Back. The main content area has a blue header 'Video Frame Rate'. Below it are five settings sections, each with a text label, a numeric input field, and a 'Save' button. The settings are: MJPEG Frame Rate Setting (25), H264-1 Frame Rate Setting (8), H264-2 Frame Rate Setting (25), H264-3 Frame Rate Setting (25), and H264-4 Frame Rate Setting (25).

MJPEG / H.264-1 / H.264-2 / H.264-3 / H.264-4 Frame Rate:

The default setting of MJPEG/H.264-1/H.264-2/H.264-3/H.264-4 Frame Rate is 25 fps. The setting range is from 1 to 25.

Click on <Save> to confirm the setting.

NOTE: A lower frame rate will decrease video smoothness.

10.5. Audio (Audio and Bit Rate Settings)

The audio setting page is shown below. In the Audio page, the Administrator can select one transmission mode and the audio bit rate.

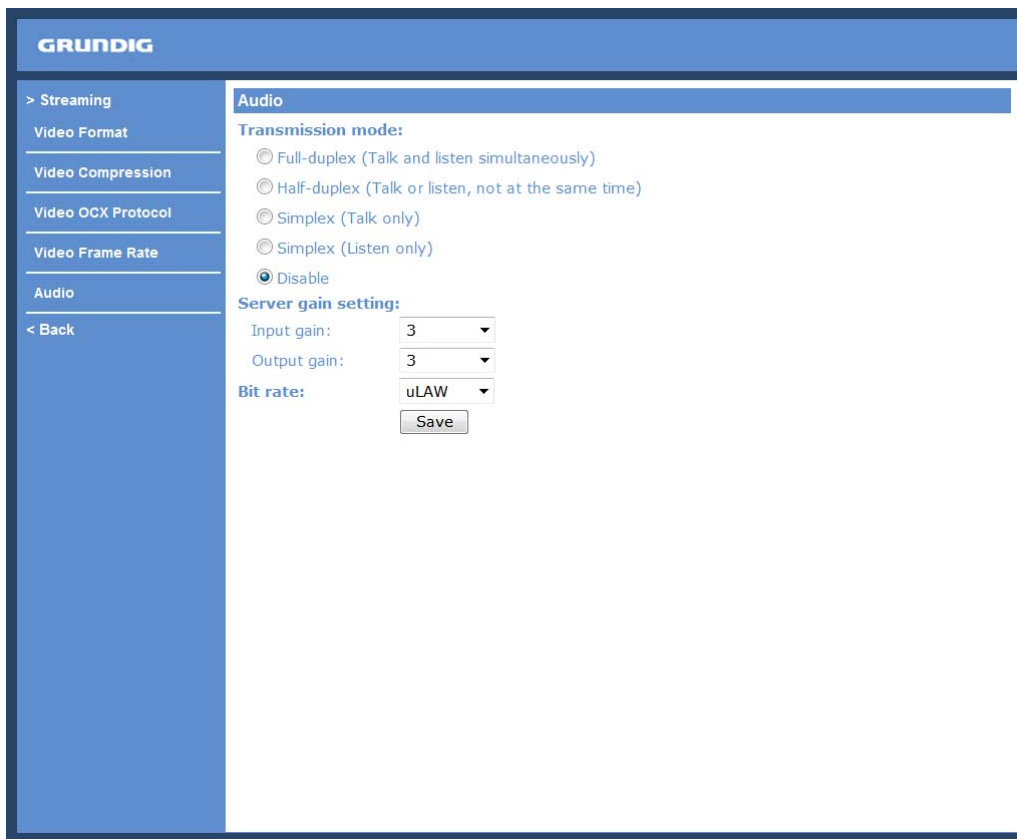

Transmission Mode :

- Full-duplex (Talk and Listen simultaneously):

In the Full-duplex mode, the local and remote sites can communicate with each other simultaneously, i.e. both sites can speak and be heard at the same time.

- Half-duplex (Talk or Listen, not at the same time):

In the Half-duplex mode, the local/remote site can only talk or listen to the other site at a time.

- Simplex (Talk only):

In the Talk only Simplex mode, the local/remote site can only talk to the other site.

- Simplex (Listen only):

In the Listen only Simplex mode, the local/remote site can only listen to the other site.

- Disable:

Select this item to turn the audio transmission function off.

Server Gain Setting :

Set the audio input/output gain levels for sound amplification. The audio gain values are adjustable from 1 to 6. The sound will be turned off if the audio gain is set to "Mute".

Bit Rate :

The selectable audio transmission bit rates include 16 Kbps (G.726), 24 Kbps (G.726), 32 Kbps (G.726), 40 Kbps (G.726), uLAW (G.711) and ALAW (G.711). Both uLAW and ALAW signify 64 Kbps but in different compression formats. A higher bit rate signifies a higher audio quality and requires a bigger bandwidth.

Click on "Save" to confirm the setting.

11. PTZ Settings

Under the “PTZ” category, users are allowed to program Preset Point(s), Cruise Line(s), Auto Pan Path(s) and Sequence Line(s) via PTZ controls. Additionally, various camera settings including Auto Exposure (AE), White Balance (WB), Back Light Compensation (BLC), Sharpness, Exposure Compensation, Digital Zoom, etc. can also be set here.

11.1. Preset

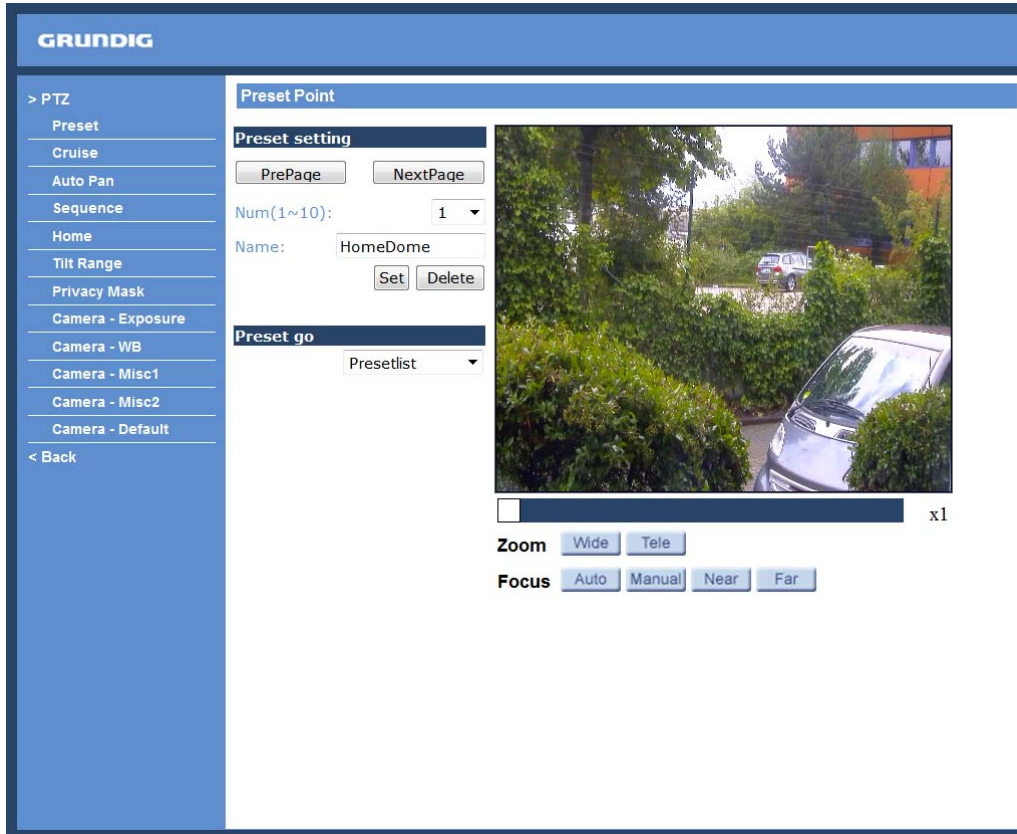

In total, 256 Preset Points can be programmed for the Motordome Camera. Please refer to the instructions below to set a Preset Point.

Preset Setting :

To set up a Preset Point, please first move the cursor to the live view pane. Then left-click and drag the red pointer with the PTZ controls to a desired position. Subsequently, assign a number for the current position from the drop-down Number List and enter its descriptive name. Press the button “Set” to save the setting.

Preset Go :

To have the camera move to a specified Preset position, please select the Preset Point from the drop-down Preset List. Then the camera shall readily move to the target position.

11.2. Cruise

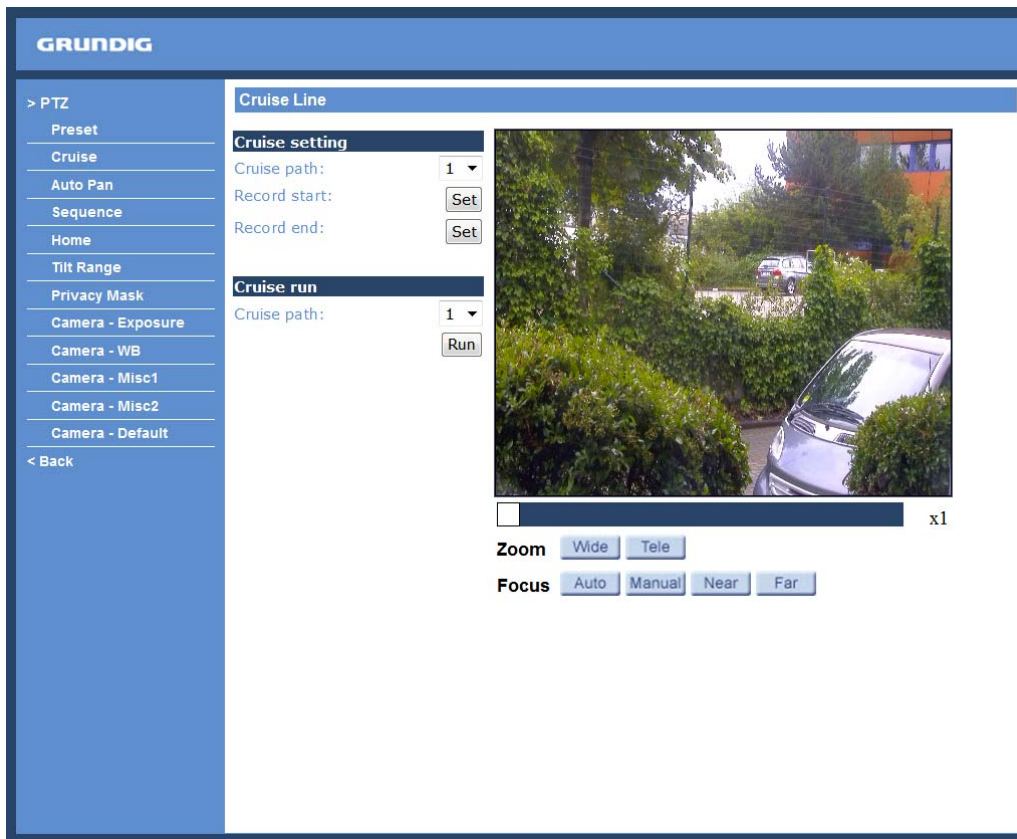

The Motordome Camera supports up to eight Cruise Paths. Please follow the instructions below for the setup of a Cruise Path.

Cruise Setting :

To set up a Cruise Path, please first select a path number from the drop-down list. Then move the cursor to the live view pane, and move the camera to a desired view (via PTZ controls) as the start point of a Cruise Path. Press the "Set" button next to the menu item "Record Start" and start programming the Cruise Path via PTZ controls. When finishing programming, press the "Set" button next to the menu item "Record End" to quit. Then this Cruise Path will be automatically recorded.

Cruise Run :

Select the specified Cruise Path from the drop-down list, press the "Run" button, and then the camera will start touring around as set.

To view the camera touring around in full screen mode, please move the cursor onto the live view pane, right-click and click on "full screen" to select the full screen view. Then users can view the camera navigation in full screen.

To move back to normal view, please right-click again on the image and click on "Normal View". The camera will move back to Normal View.

To stop a running Cruise Path, simply move the cursor to the live view pane, right-click, hold the click and drag the camera in any direction.

11.3. Auto Pan

The Motordome Camera supports four Auto Pan Paths. Please refer to the instructions below to set an Auto Pan Path.

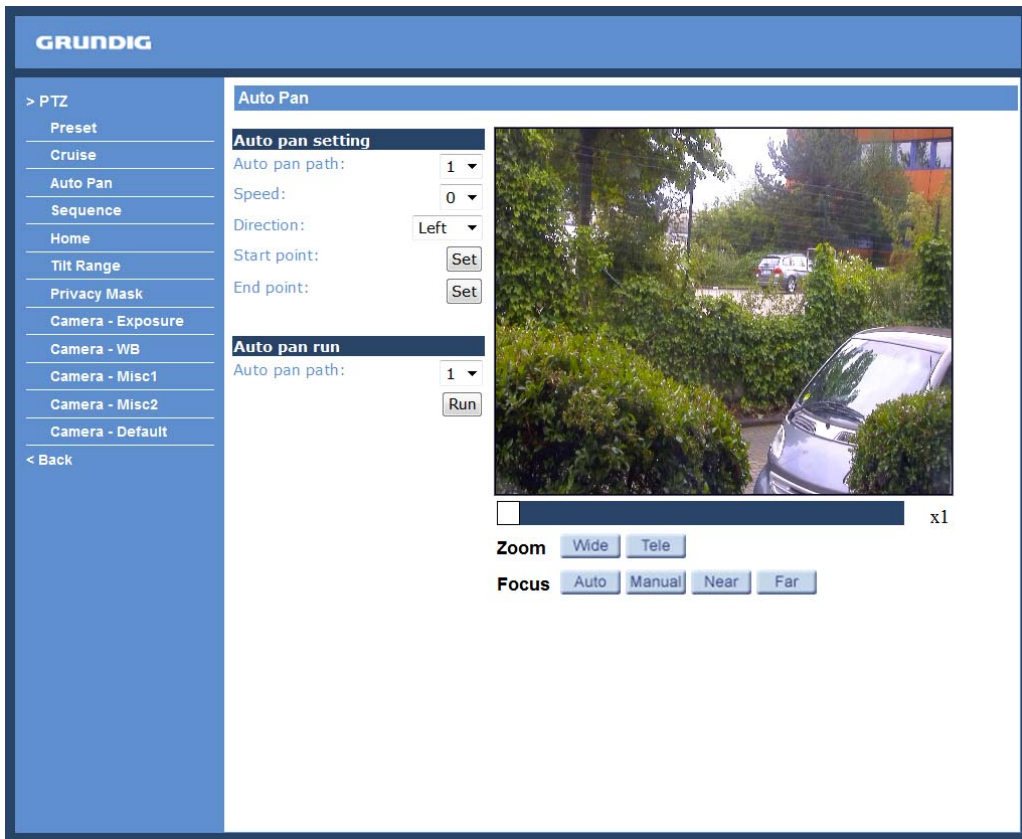

Auto Pan Setting :

To set up an Auto Pan Path, please select first a path number from the drop-down list. Then move the cursor to the live view pane, and move the camera to a desired view as the Start Point of an Auto Pan Path. When you click on the “Set” button next to the menu item “Start Point”, the current view will be automatically saved as the start point of the Auto Pan Path.

NOTE: The room ratio of an Auto Pan’s Start Point will persist throughout the whole path.

Enter the speed ratio into the Speed field. The speed ratio ranges from 0 (low) to 3 (fast). Then choose from the Direction drop-down list whether the Auto Pan Path should run in right or left direction.

Move the camera to another desired position as the end point of the Auto Pan Path. Click on the “Set” button next to the menu item “End Point” for saving the setting.

Auto Pan Run :

Select the specified Auto Pan Path from the drop-down list, press the “Run” button, and then the camera will start moving horizontally as recorded.

To view the camera panning in full screen mode, please move the cursor onto the live view pane, right-click and click on “full screen” to select the full screen view. Then users can view the camera navigation in full screen. To move back to normal view, please right-click again on the image and click on “Normal View”. The camera will move back to Normal View.

To stop running an Auto Pan Path, simply move the cursor to the live view pane, right-click, hold the click and drag the camera in any direction.

11.4. Sequence

The Motordome Camera supports in total eight Sequence Lines. Each Sequence Line consists of up to 64 Preset Points. Please refer to the instructions below to program a Sequence Line.

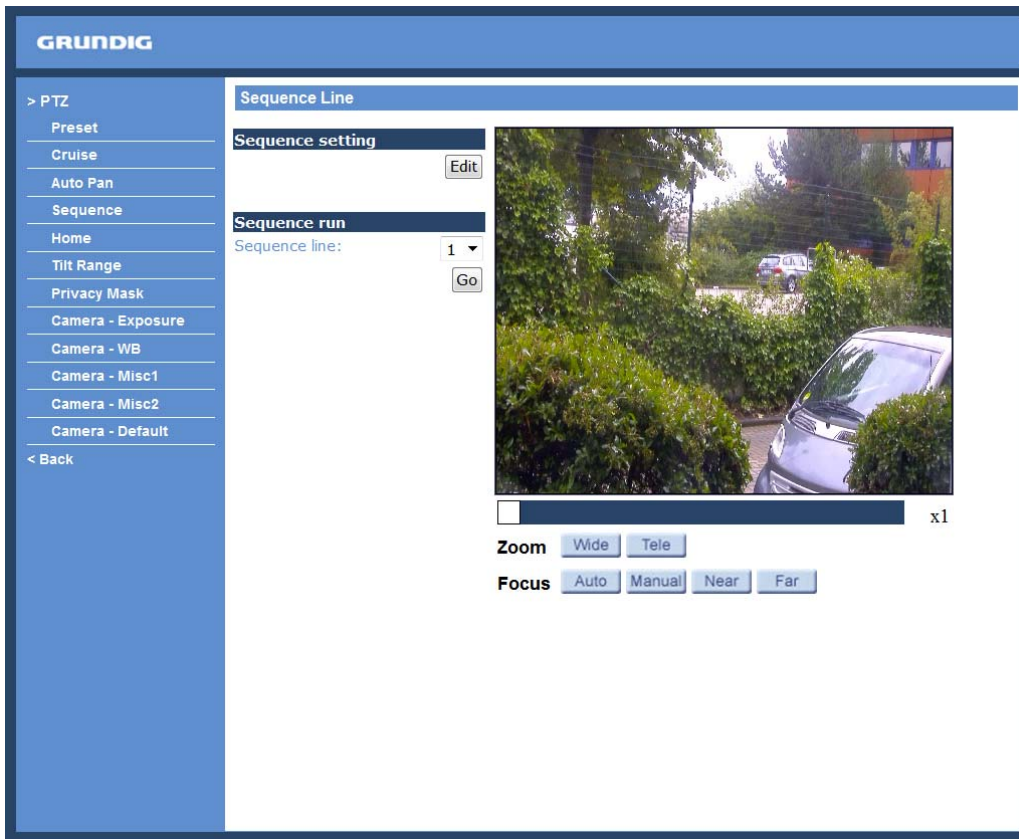

NOTE: Before setting this function, users must pre-define at least two Preset Points.

Sequence Setting :

Please press the "Edit" button in the "Sequence Setting" section to enter the Sequence setting as shown in the following picture.

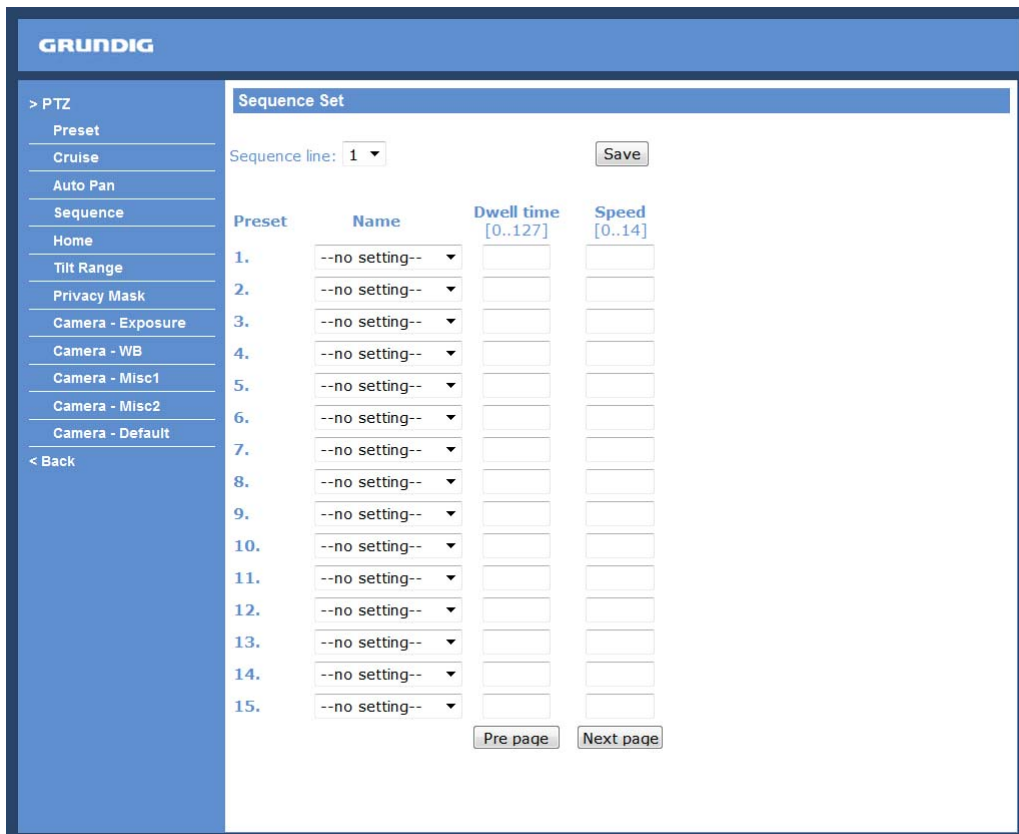

- Sequence Line:

Please select the number of Sequence Lines to be set from the drop-down list on the top of the Sequence setting menu.

- Sequential Preset Points Setting:

Please set up each Preset Point of the programmed Sequence Line in order, by assigning a Preset Point from the "Name" list to one of the specified Preset numbers and by entering both Dwell Time (0~225) and Speed (0~14) into the corresponding fields.

After finishing the sequential Preset Points setting, please click on the button "Save" in the top of the Sequence setting menu.

Sequence Run :

Select the specified Sequence Line from the drop-down list, click on the "Go" button, and then the camera will start moving forward to each scene sequentially as programmed.

To view the camera executing a Sequence Line in full screen mode, please move the cursor onto the live view pane, right-click and click on "full screen" to select the full screen view. Then users can view the camera navigation in full screen.

To move back to normal view, please right-click again on the image and click on "Normal View". The camera will move back to Normal View.

To stop running the Sequence Line, simply move the cursor to the live view pane, right-click, hold the click and drag the camera in any direction.

11.5. Home

Users are able to set an operation mode to ensure constant monitoring. If the Dome Camera idles for a period of time, the selected function will be activated automatically - this is the HOME function. The HOME function allows constant and accurate monitoring to avoid that the Dome Camera stops or misses events.

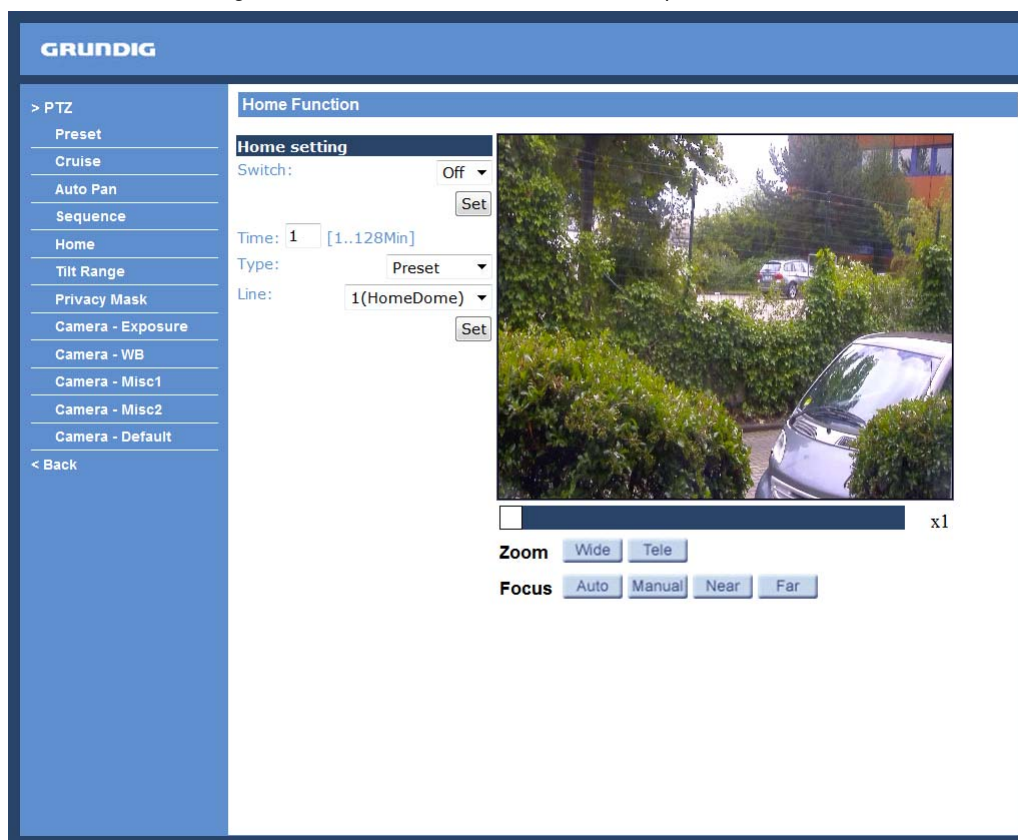

Home Setting :

- Switch:

Select "On" or "Off" to activate or disable the Home function. Then click on the "Set" button to save the setting.

- Time:

The time here represents the duration of camera idle time previous to running a Preset Point/Cruise Line/Auto Pan Path/Sequence Line. When the Home function is activated, the Dome Camera will start to count down when it idles, and then execute the predefined action as time expires. The time period ranges from 1 to 128 minutes; please specify it in the field.

- Type/Line:

Please select a Home action type (Preset Point/Cruise Line/Auto Pan Path/Sequence Line) from the drop-down list "Type" and select the number of the Preset Point/Cruise Line/Auto Pan Path/Sequence Line from the drop-down list "Line". Click on the button "Set" to save the Home settings.

11.6. Tilt Range

The Motordome Camera's tilt angle is adjustable from minimum -10° to maximum 100° . Please enter the desired min. and max. tilt angle into the corresponding fields. Click on the "Set" button to save the tilt angle settings.

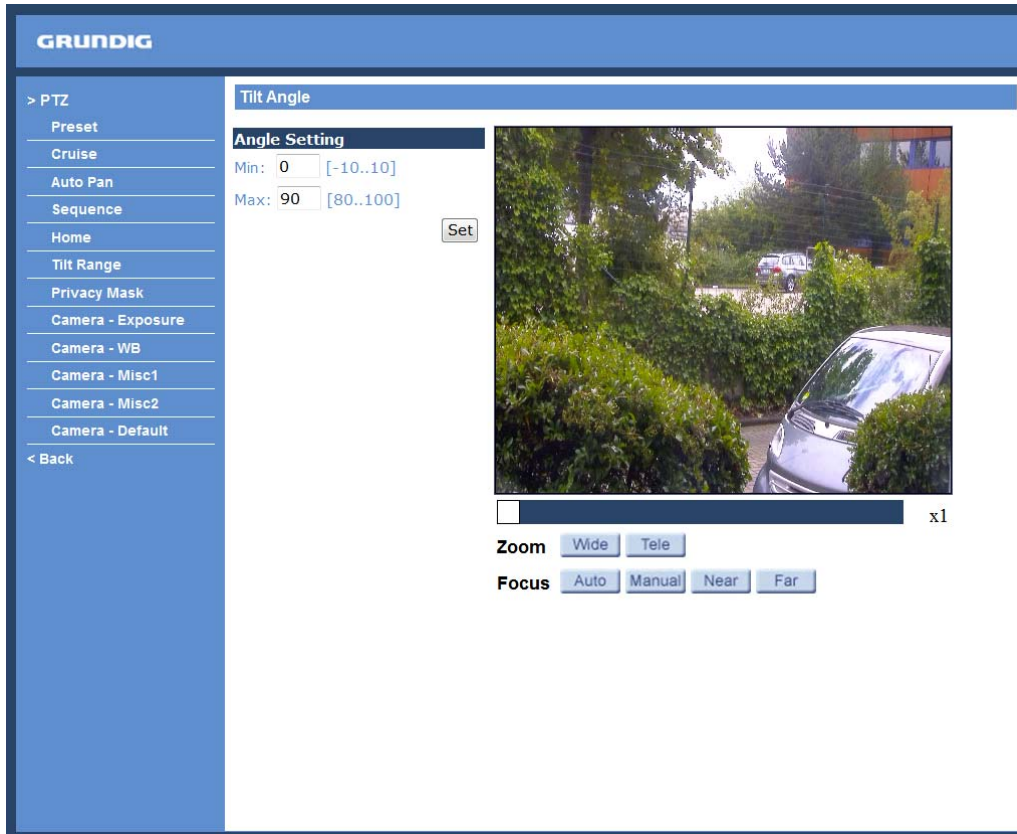

11.7. Privacy Mask

The Privacy Mask function aims to avoid any intrusive monitoring. When setting a mask, it is suggested to set it at least twice bigger (height and width) than the masked object. The Dome Camera will assume that the center of the selected view is the starting point. Therefore, please keep the target object/region positioned in the center of the scene. Please refer to the following descriptions for setting up a privacy mask.

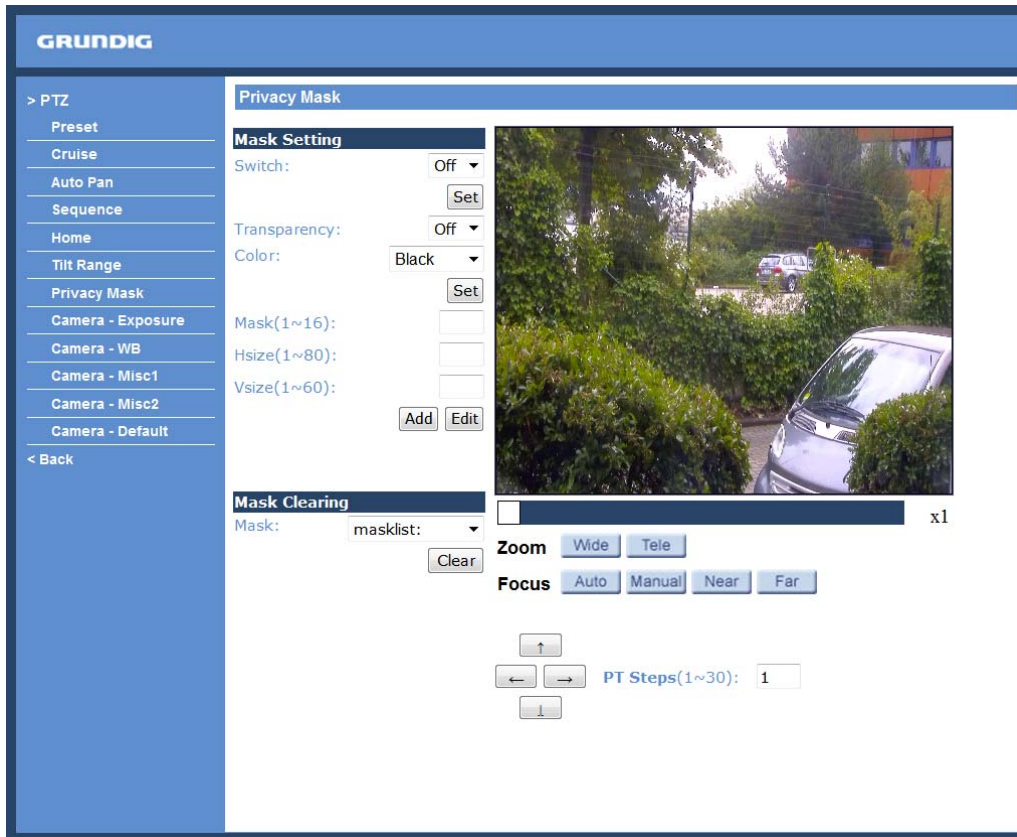

NOTE: The Image Flip function (see section 11.10. Camera — Miscellaneous Setups 1) and the Image Inverse function (see section 11.11. Camera — Miscellaneous Setups 2) will be disabled automatically when the Privacy Mask function is enabled.

Mask Setting :

- Switch:

The Privacy Mask function can be activated or disabled. Click on the button “Set” to save the setting.

- Transparency:

The Privacy Mask can be set as transparent if necessary.

- Colour:

Select a desired colour from the “Colour” drop-down list for the specified Privacy Mask.

Click on the button “Set” to save the Privacy Mask’s colour properties.

- Mask:

Specify the number of the programmed Privacy Mask in the corresponding field. The number of Privacy Masks varies with the camera models.

- HSize/VSize:

The size of a Privacy Mask can be customised through specifying its horizontal and vertical size. The value of the “Horizontal Size” ranges from 1 ~ 80, while the “Vertical Size” value ranges from 1 ~ 60.

After finishing the setup of a Privacy Mask, please click on the “Add” button to save the programmed Privacy Mask.

Mask Clearing :

In this section, users can delete an existing Privacy Mask. Please select the Privacy Mask to be removed from the drop-down list, and click on the button "Clear". Then the selected Privacy Mask will readily disappear.

11.8. Camera - Exposure

In the Exposure setting page, users can select either the "Full Auto" mode or adjust the parameter of the Shutter Priority/Iris Priority mode for optimised video output according to the operating environment. The Maximal Gain can be either turned off or set from 3 to 57 dB.

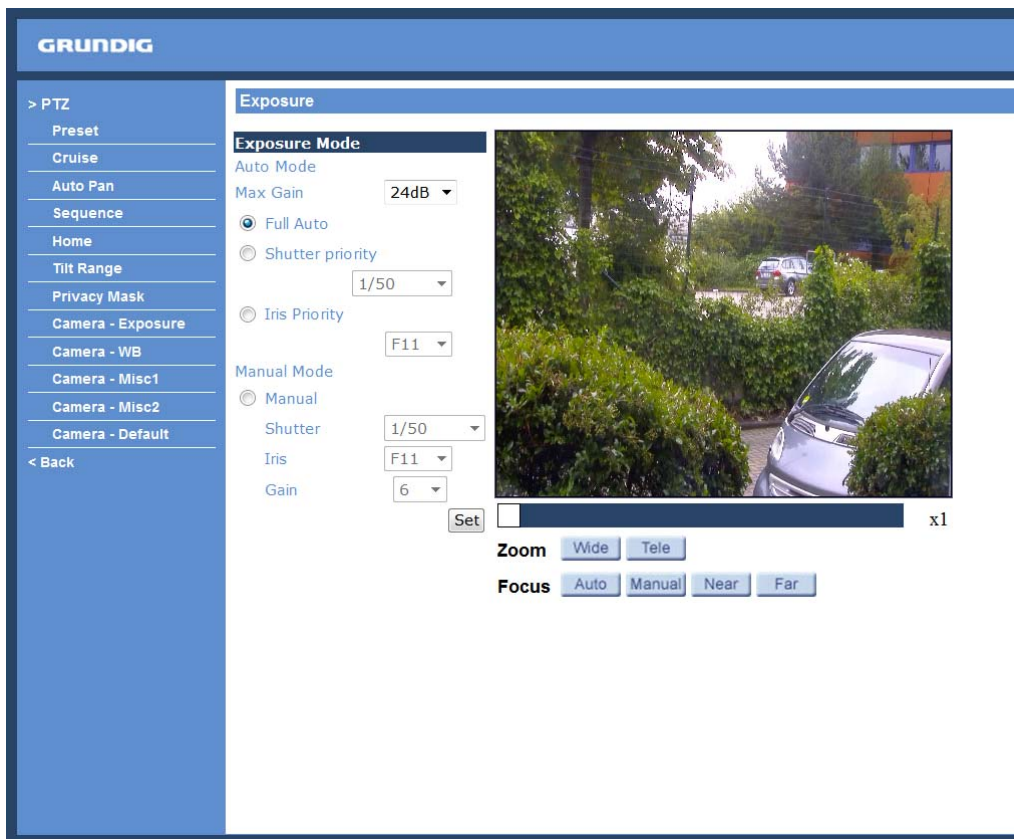

Shutter Priority :

In this mode, it is the shutter speed that takes the main control of exposure. The range of the shutter speed is from 1/10000 ~ 1/50.

Iris Priority :

In this mode, it is the iris that has the premier priority in controlling the exposure. The value of the iris is adjustable from F1.6 to F28.

Manual :

In this mode, the shutter speed is adjusted manually. Please only use this setting when the light conditions are consistent. The shutter speed is adjustable from 1 to 1/10000. The Iris can be adjusted from F1.6 to F28 and the Gain can be set from 1 to 15.

11.9. Camera - WB

To display natural colours, the camera needs to know the reference colour temperature of the light source. Based on this reference colour temperature the camera will calculate the correct values for all colours. The camera can perform a measurement by itself or the user can set up the reference colour temperature manually. The scale unit of the colour temperature is Kelvin [K]. The following list shows the colour temperature of some light sources for reference.

The users can select one of the White Balance Control modes according to the operating environment.

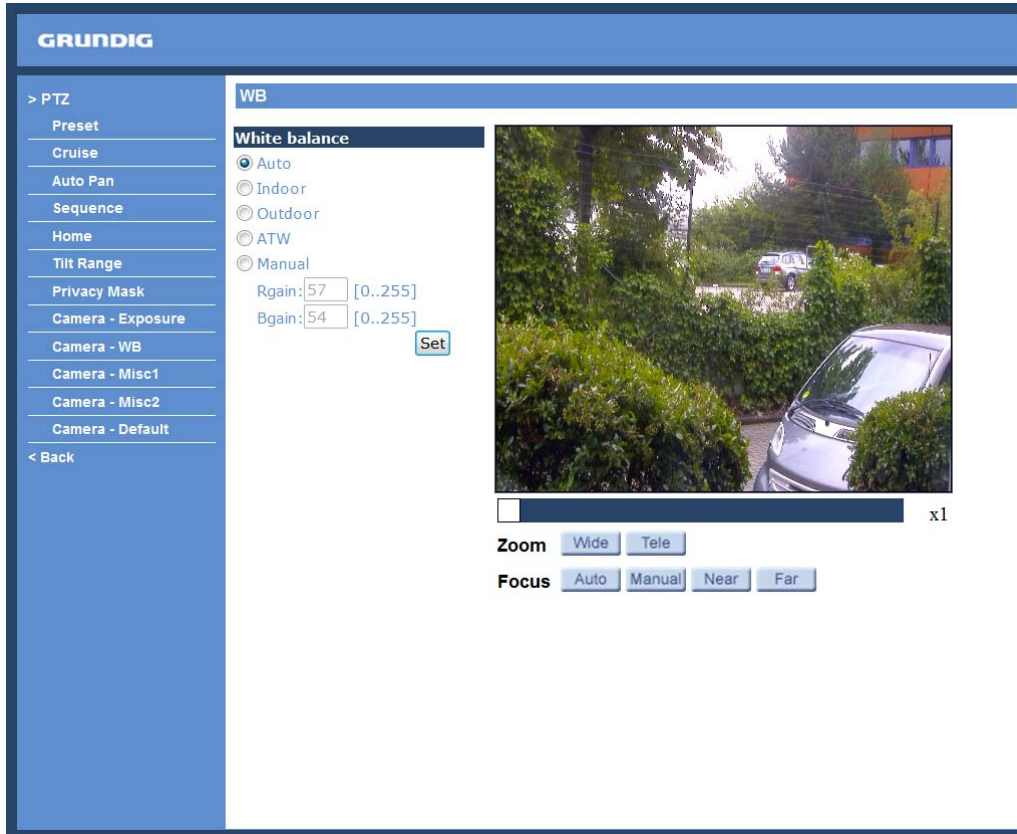

Light Sources :

Cloudy Sky (Colour Temperature: 6,000 to 8,000 K)

Noon Sun and Clear Sky (Colour Temperature: 6,500 K)

Household Lighting (Colour Temperature: 2,500 to 3,000 K)

75-watt Bulb (Colour Temperature: 2,820 K)

Candle Flame (Colour Temperature: 1,200 to 1,500 K)

Auto Mode :

In this mode, the white balance works within its colour temperature range and calculates the best-fit white balance.

Indoor/Outdoor Mode :

Select Indoor or Outdoor.

ATW Mode (Auto Tracing White Balance) :

The Dome Camera adjusts the White Balance continuously in a range from 2000 K to 10000 K.

Manual Mode :

In this mode, the users can change the White Balance value manually via specifying R-Gain and B-Gain. The range of R/B-Gain is from 0 to 255.

11.10. Camera - Misc 1

In Camera—Misc (Miscellaneous Setups) 1, users can set various camera parameters including Backlight Compensation (BLC), Sharpness, Exposure Compensation (ExpComp), Image Flip, Digital Zoom and the ICR function. Each setting is specified as follows:

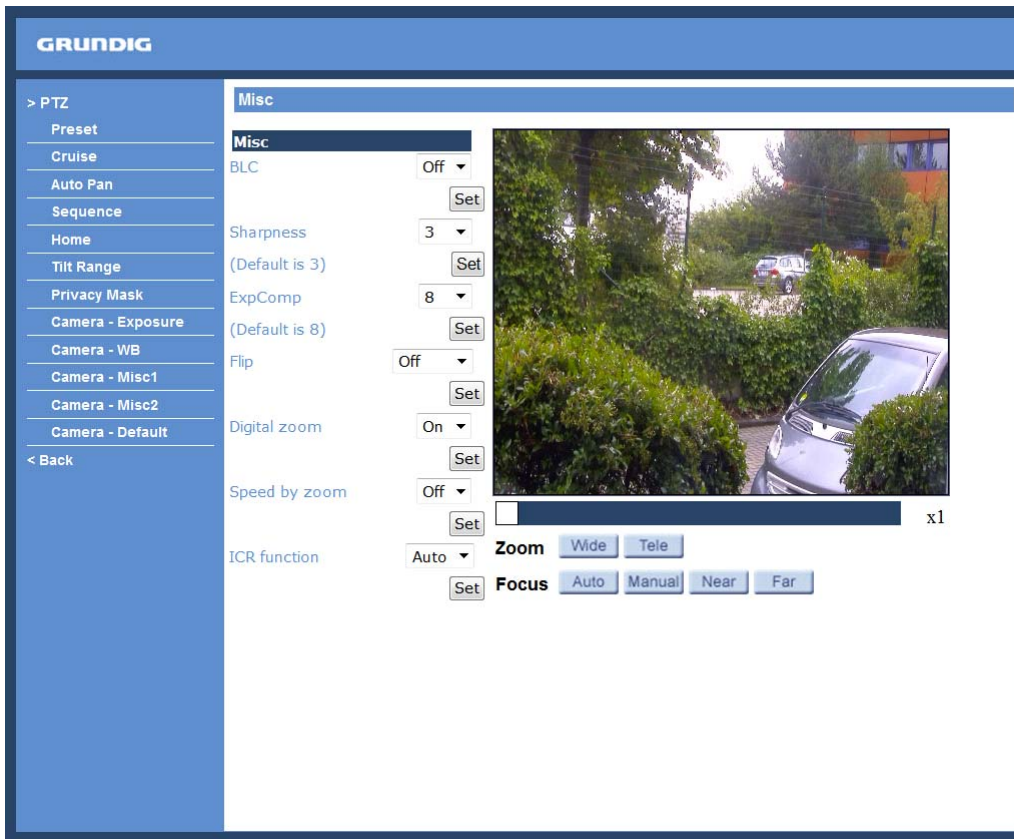

BLC :

Users can choose to activate or disable the BLC function. Click on the button “Set” to save the setting.

Sharpness :

Increasing the sharpness level can make the image look sharper; it especially enhances the object’s edges. The Sharpness value is adjustable from 1 to 15. Click on the button <Set> to confirm the setting.

ExpComp :

Users can define the value of Exposure Compensation. The value ranges from 1 to 15.

Flip :

Users can track an object continuously when it passes through under the Dome Camera with setting Flip to Mechanical (M.E.) mode or Digital Flip (Image) mode.

NOTE: The Flip setting can only be controlled manually. If a Preset Position or a point for another function (e.g. Sequence) is set in a position that can only be reached through the FLIP motion: when the Flip function is turned off, the position cannot be reached anymore.

NOTE: To make the Dome Camera tilt between a specific range, such as -10° to +100° or -10° ~ +190°, please go to the Tilt Range setting page to set the tilt angle range. Otherwise, the Dome Camera will tilt 90° as default setting.

- M.E. Mode:

M.E. is a standard mechanical operation. As the Dome Camera tilts to the maximum angle, it will pan 180°, and then continue tilting to keep tracking an object.

- Image Mode:

IMAGE represents digital IMAGE FLIP, which enables users to keep tracking objects seamlessly. In this mode, almost no delay occurs, compared to M.E. mode.

NOTE: The Privacy Mask function will be automatically disabled when the Image Flip function is enabled.

Speed by Zoom :

Enable this function to adjust the pan/tilt speed automatically by an internal algorithm when zooming. A larger zoom ratio leads to a lower rotation speed. Click on the <Set> button to save the setting.

ICR Function :

When you detach the IR cut filter from the image sensor and turn off the colour burst function, you will get a black-and-white picture. The light does not have to go through the filter any more, therefore more light enters the image sensor and a clearer picture, while the same light conditions persist, will be displayed. As a result, the sensor's sensitivity to light will be enhanced. Without the IR cut filter the image sensor can now also process IR-"light".

- Auto:

In Auto mode, the internal circuit will automatically decide to remove the IR cut filter according to the image brightness level (if necessary).

- On:

Select this item to remove the IR cut filter.

- Off:

Select this item to disable the IR function.

11.11. Camera - Misc 2

In Camera — Misc (Miscellaneous Setups) 2, users can set up various functions such as Auto Calibration, Wide Dynamic Range (WDR) and 2D Noise Reduction.

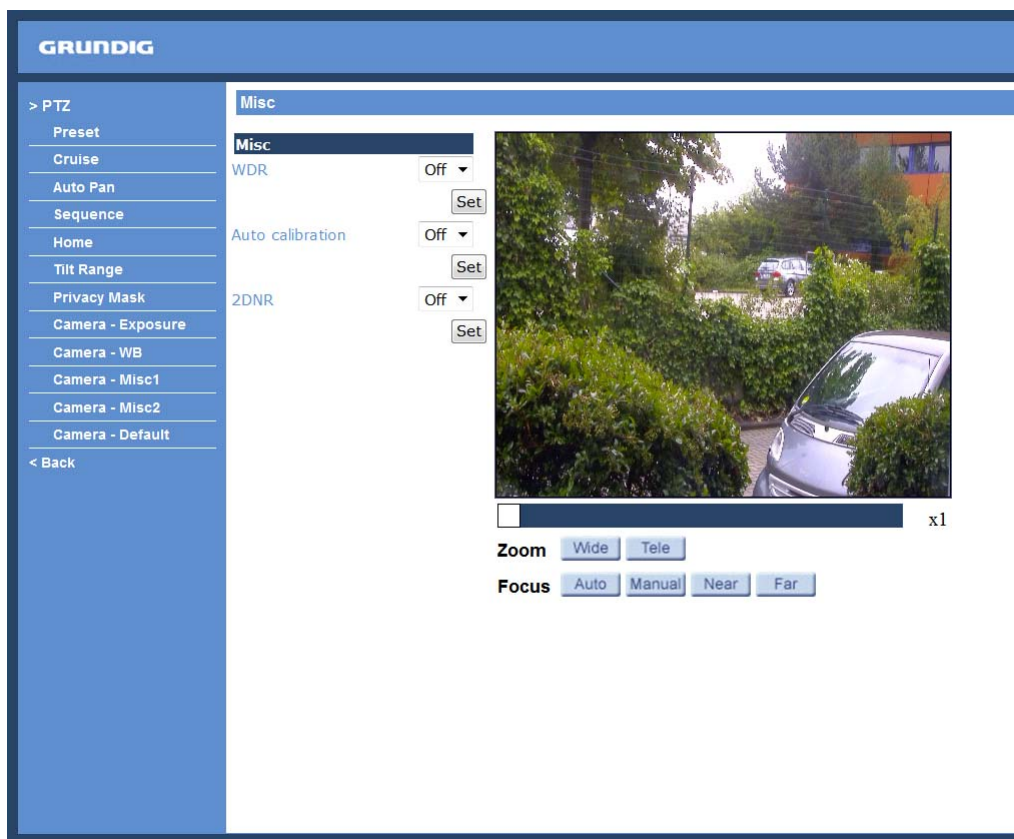

WDR :

The WDR function is especially effective in an environment with extreme contrast. Click on the "Set" button when the setting is finished.

Auto calibration :

With the Auto calibration function, the Motordome Camera calibrates automatically when the deviation of dome pivot is detected. Click on the "Set" button when the setting is finished.

2DNR :

With the 2D Noise Reduction function, the processor analyses pixel by pixel and frame by frame to eliminate environmental noise signals so that the highest image quality can be produced, even in low light conditions. Press the "Set" button when the setting is finished.

TV System :

Select the video format that matches the present TV system. Click on "Set" to confirm the new setting.

11.12. Camera - Default

In the Camera Default page, users can set the camera back to factory default simply by pressing the "Set Default" button.

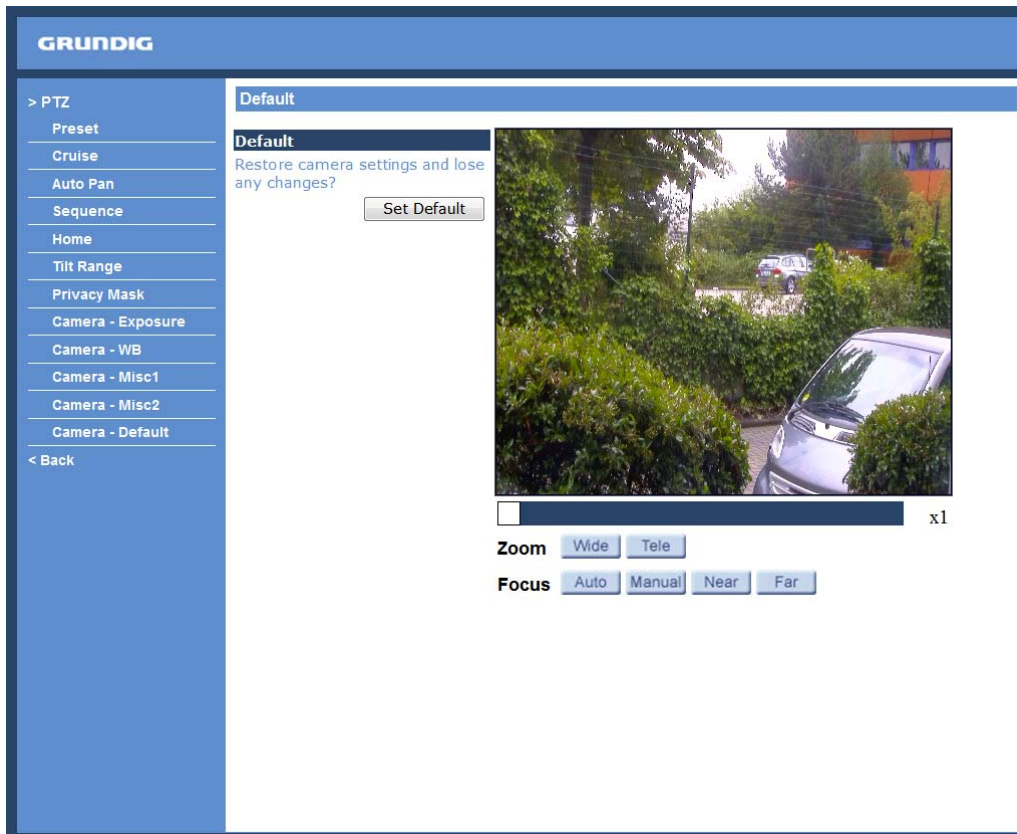

12. Logout

When you press the “Logout” tab at the top of the page, the login window will pop up. This permits login with another user name.

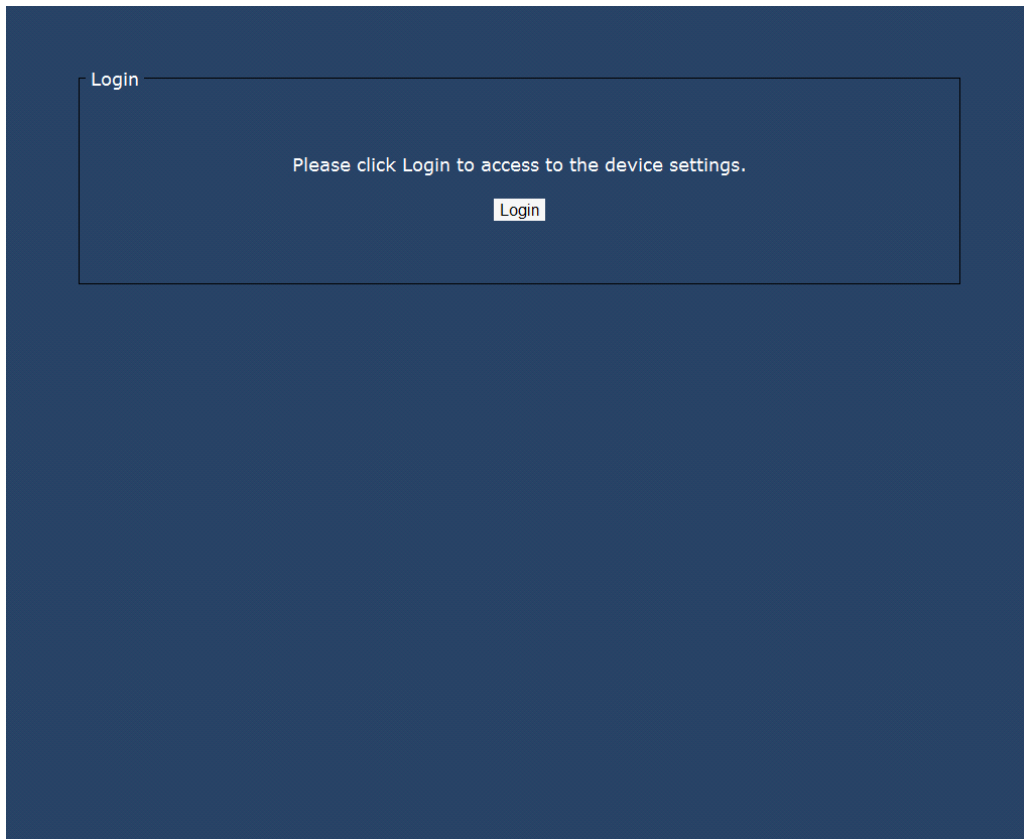

13. CMS Software Introduction

The Central Management System (CMS) software bundles IP cameras and analogue cameras that are connected to the network via the Video Server into one system. Offering powerful functionalities via intuitive interface, it is a centralised monitoring solution for your video surveillance equipments.

The GRUNDIG CMS Software gives the user access to monitor multiple IP Cameras and Video Servers, and allows the user to monitor simultaneously 16 sites per group (up to 10 groups) within several clicks.

For further information on the CMS software, please refer to the supplied CD.



14. Internet Security Settings

If the ActiveX control installation is blocked, please either set the Internet security level to default or change ActiveX controls and plug-in settings.

Internet Security Level : Default

Step 1: Start the Internet Explorer.

Step 2: Select <Tools> from the main menu of the browser. Then click on <Internet Options>.

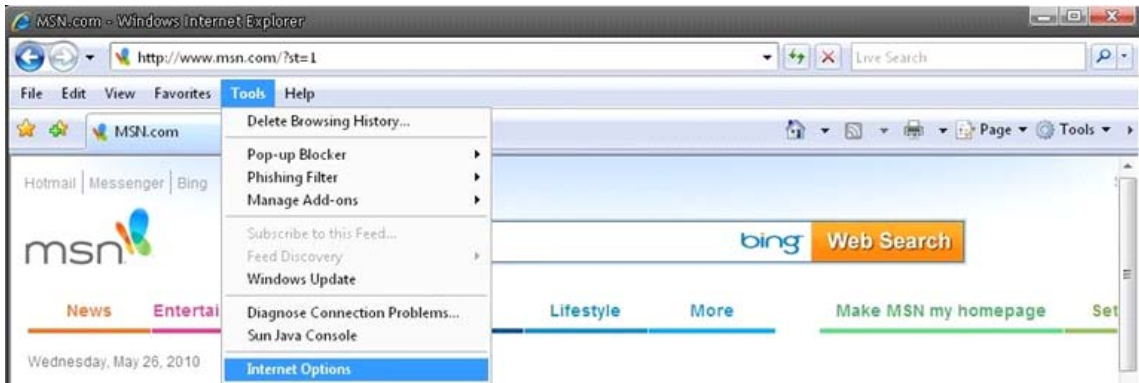

Step 3: Click on the <Security> tab, and select <Internet>.

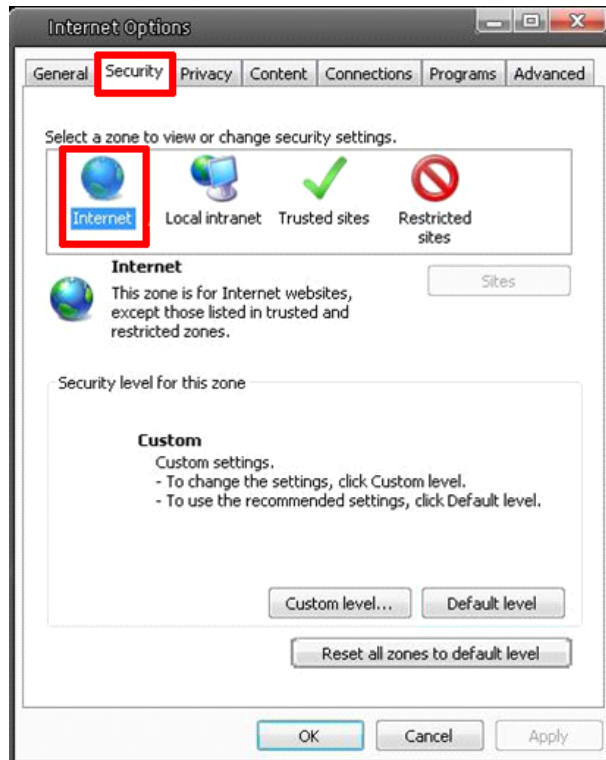

Step 4: Down the page, click on “Default level...” and then click “OK” to confirm the setting. Close the browser window, and open a new one later when accessing the IP Camera.

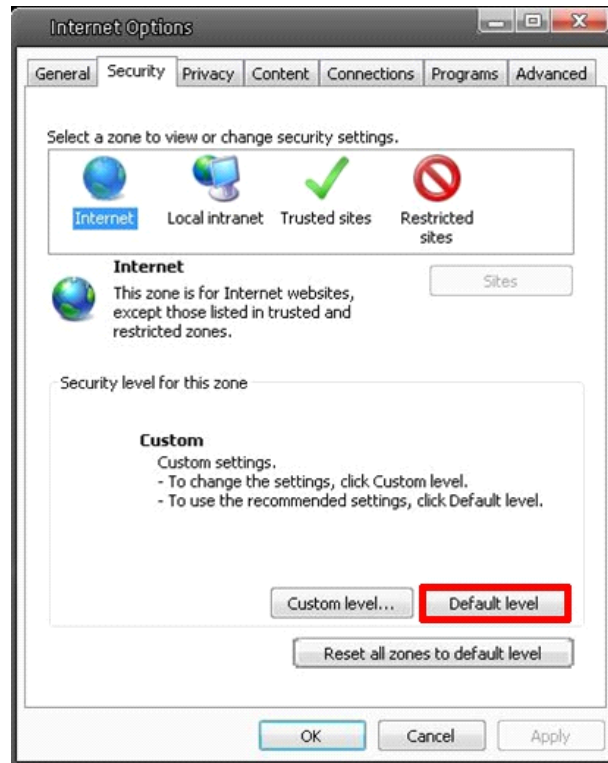

ActiveX Controls and Plug-in Settings :

Step 1~3: Please refer to the previous section above.

Step 4: Down the page, click on “Custom level...” (see the picture below) to change ActiveX controls and plug-in settings.

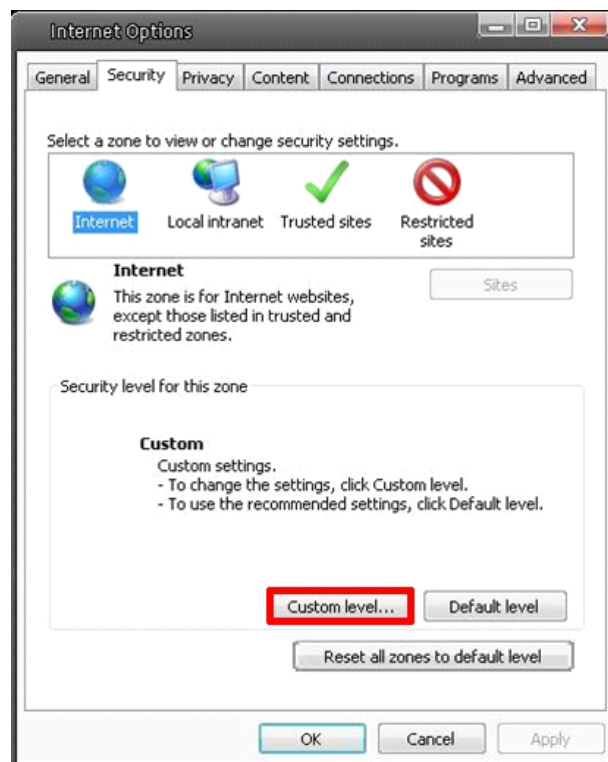

The Security Settings screen is displayed as shown below:

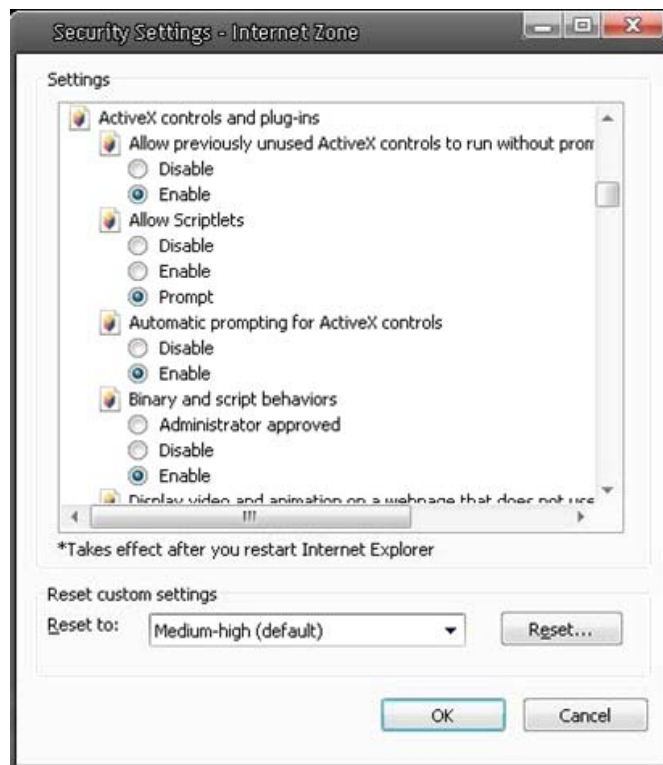

Step 5: Under "ActiveX controls and plug-ins", set ALL items (as listed below) to <Enable> or <Prompt>. Please note that the items may vary depending on the Internet Explorer version you are using.

ActiveX controls and plug-in settings:

1. Allow previously unused ActiveX controls to run without prompt
2. Allow Scriptlets
3. Automatic prompting for ActiveX controls
4. Binary and script behaviors
5. Display video and animation on a webpage that does not use external media player
6. Download signed ActiveX controls
7. Download unsigned ActiveX controls
8. Initialize and script ActiveX controls not marked as safe for scripting
9. Run ActiveX controls and plug-ins
10. Script ActiveX controls marked as safe for scripting

Step 6: Click on <OK> to accept the settings and to close the Security screen.

Step 7: Click on <OK> to close the Internet Options screen.

Step 8: Close the browser window, and open a new one later for accessing the IP Camera.

15. GRUNDIG Viewer Download Procedure

The procedure of the GRUNDIG Viewer software download is specified as follows:

Step 1: In the GRUNDIG Viewer installation page, click “Next” to start the installation.



Step 2: Setup starts. Please wait for a while until the loading bar runs out.

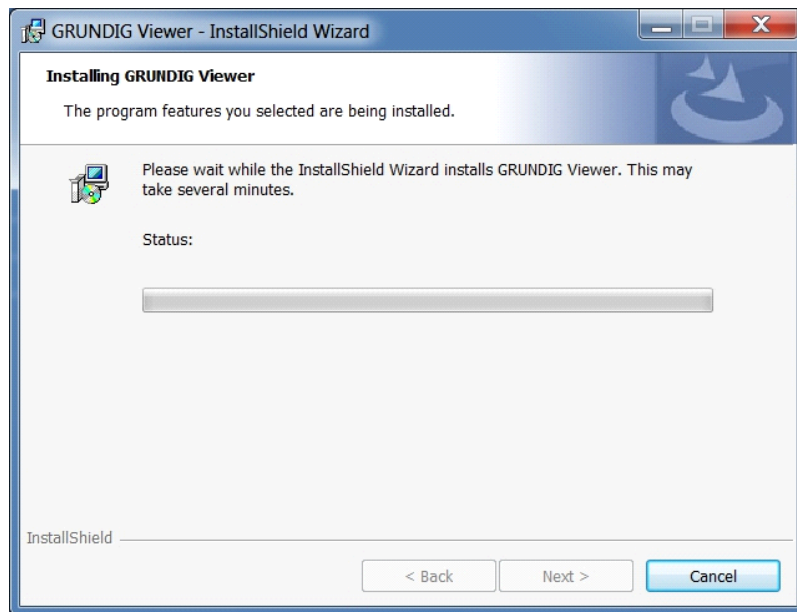

Step 3: Click on "Finish" to close the GRUNDIG Viewer installation page.

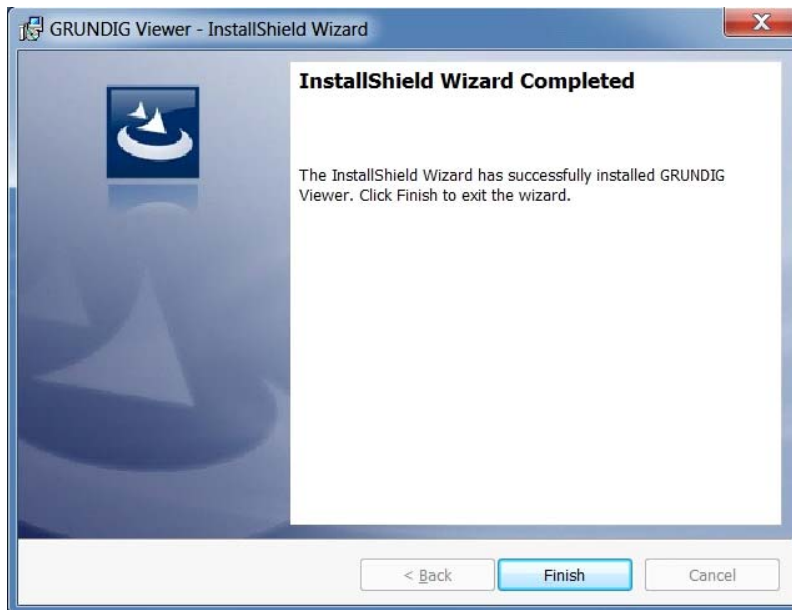

Then, the IP Camera's Home page will be displayed as follows:

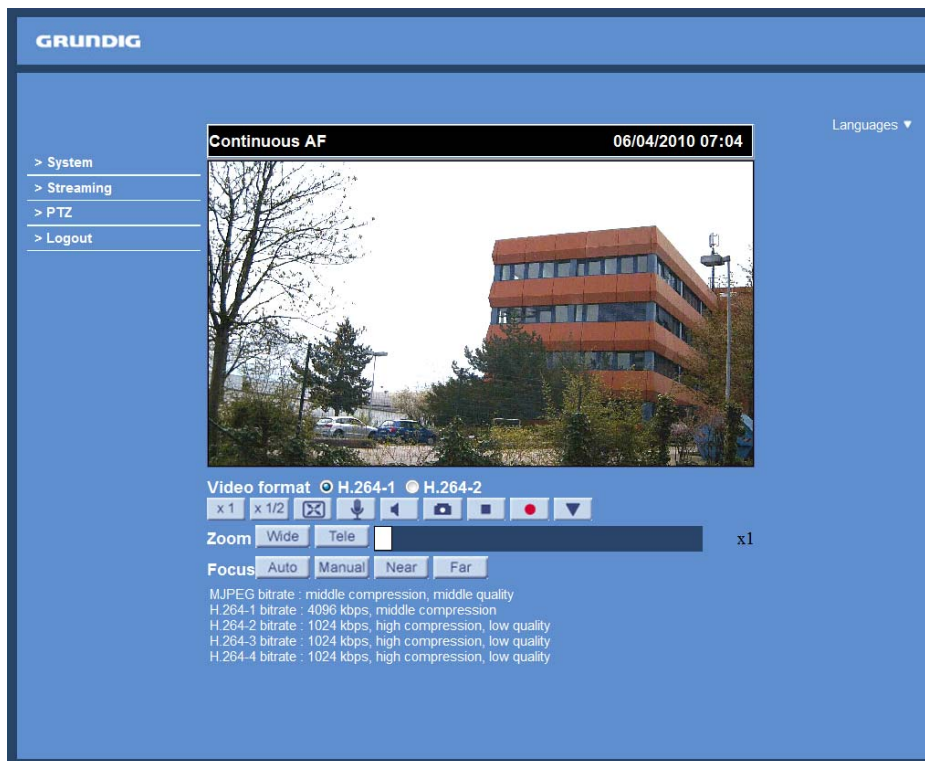

NOTE: Please note that the function buttons may vary depending on the camera model.

16. Install UPnP Components

Please follow the instructions below to install UPnP components. (The procedure is for Windows XP, for other systems please refer to the corresponding manuals.)

Step 1: Go to "Start", click on "Control Panel", and then double-click on "Add or Remove Programs".

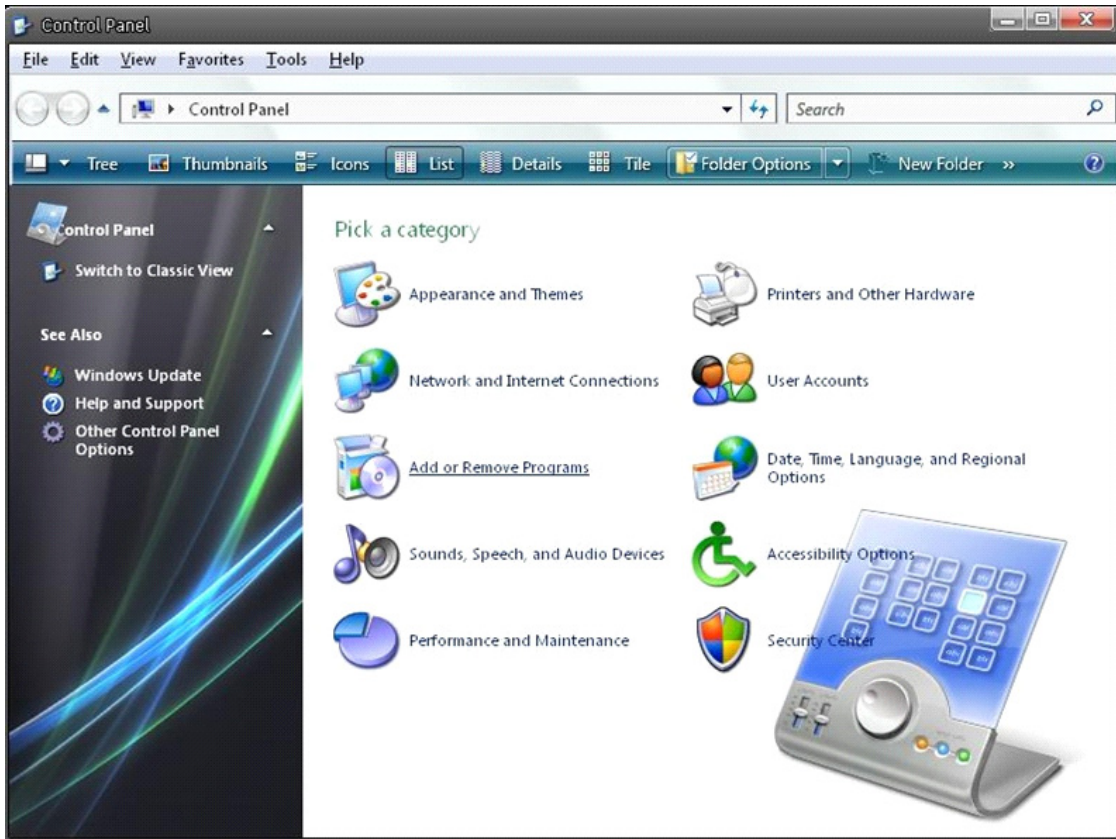

Step 2: Click on "Add/Remove Windows Components" in the Add or Remove Programs page.

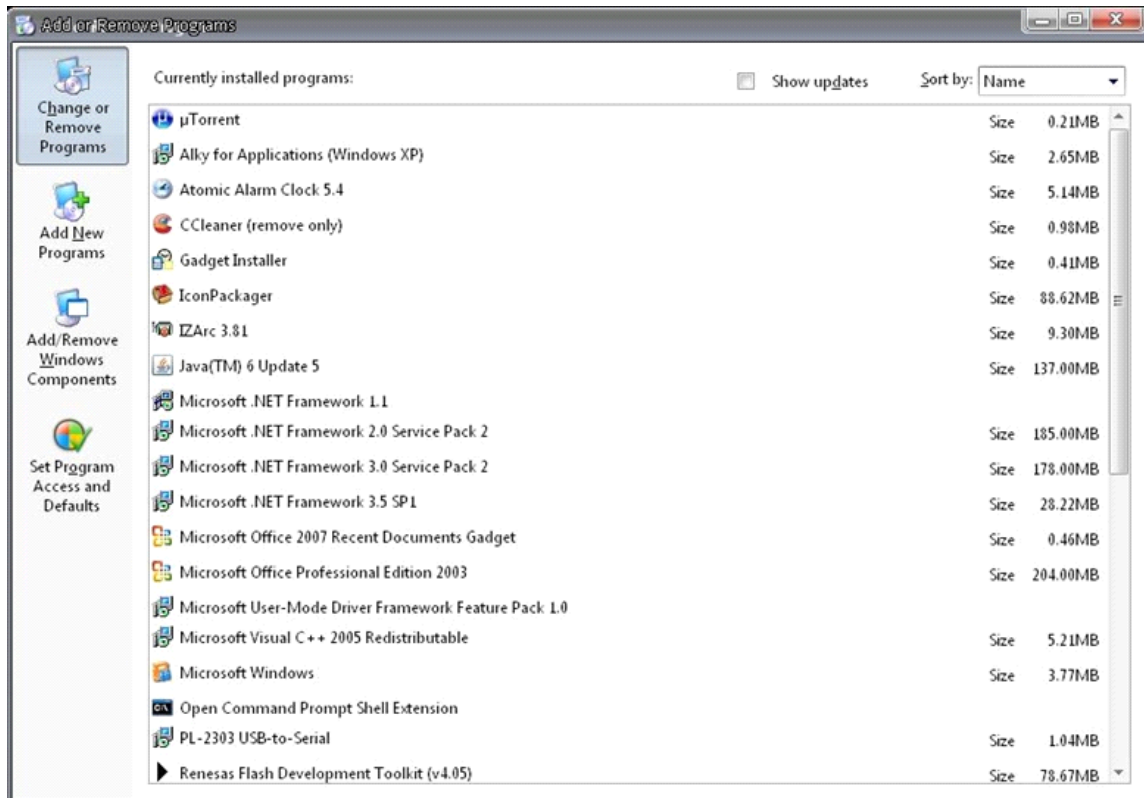

Step 3: Select "Networking Services" from the Components list in the Windows Components Wizard window, and then click on "Details".

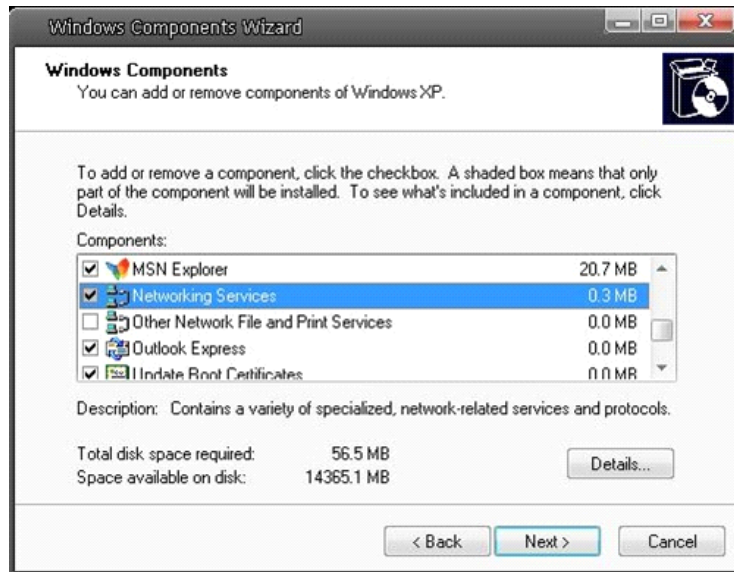

Step 4: Select "UPnP User Interface" in the Networking Services' subcomponents list and then click on "OK".

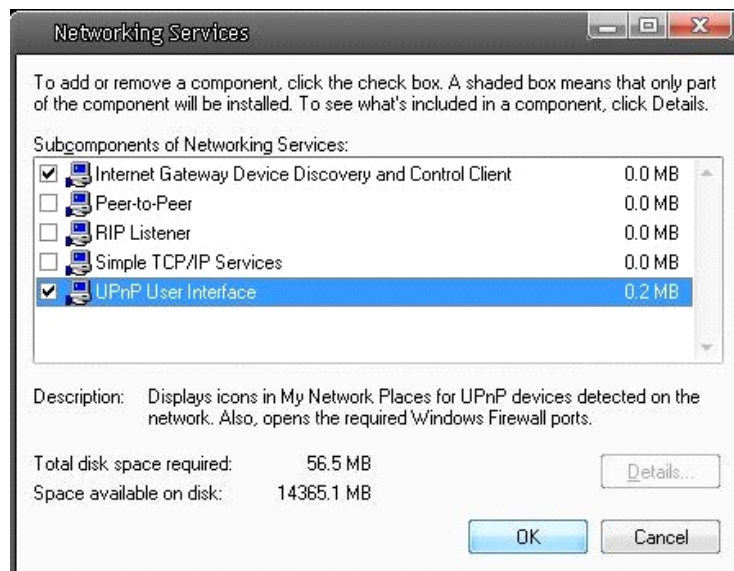

Step 5: Click on "Next" in the Windows Components Wizard page.

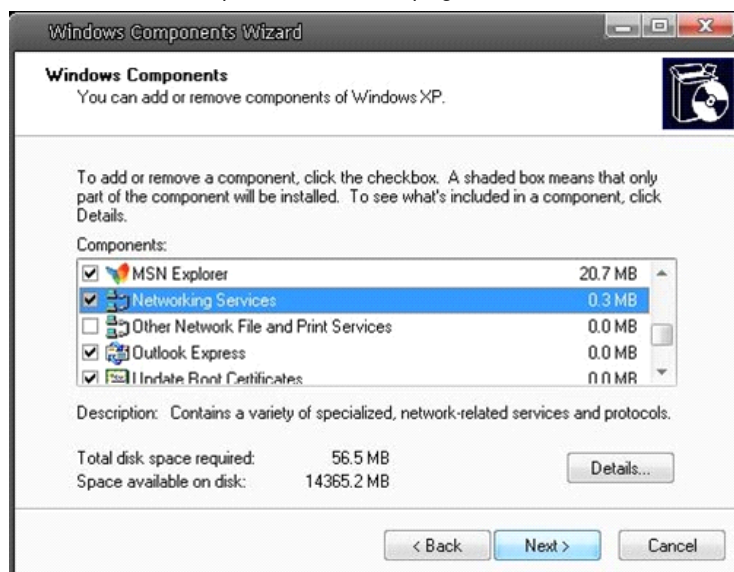

Step 6: Click on "Finish" to complete the installation.



17. Deleting the Existing GRUNDIG Viewer

Users who have installed the GRUNDIG Viewer for 1.3 Megapixel Series IP Cameras on the PC need to delete the existing GRUNDIG Viewer first from the PC before accessing this IP Camera.

Deleting the GRUNDIG Viewer :

Click on "Control Panel", and then click on "Add or Remove Programs". In the "Currently installed programs" list, select "GRUNDIG Viewer" and click the button "Remove" to uninstall the existing GRUNDIG Viewer as shown in the figure below.

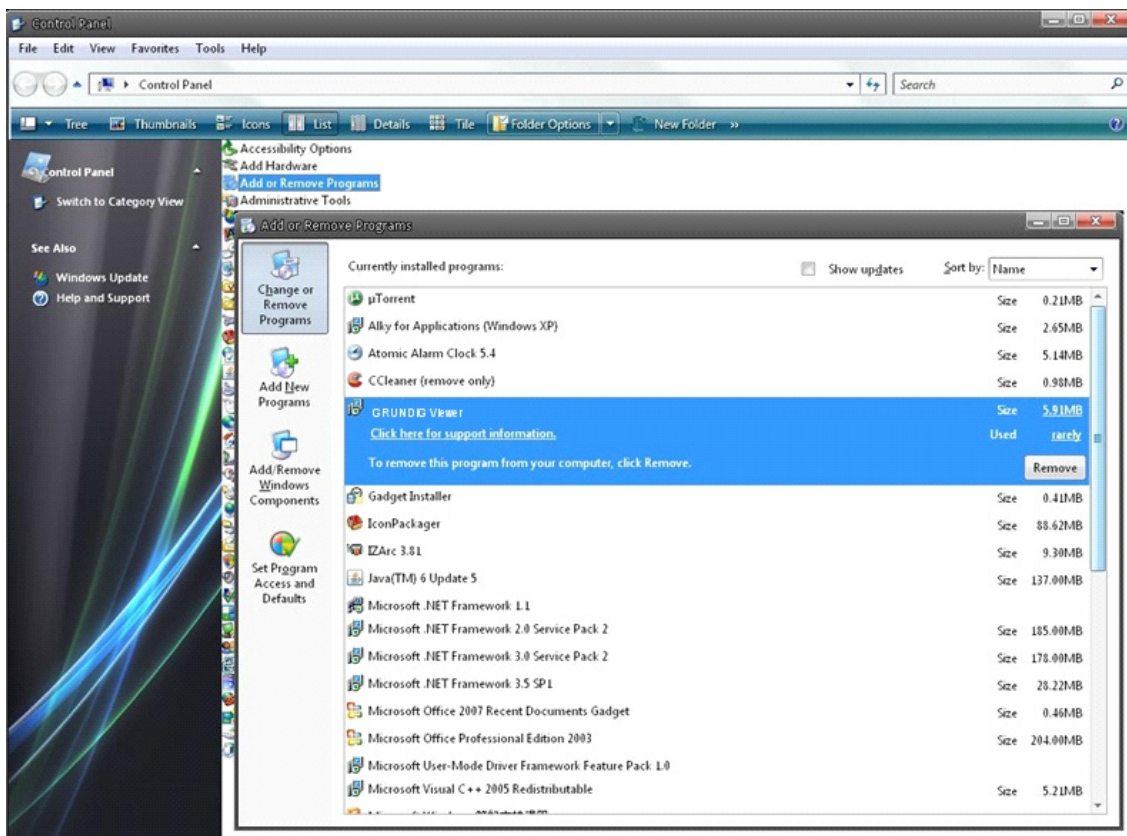

Deleting Temporary Internet Files :

To improve the browser performance, it is suggested to clean up all the files in the Temporary Internet Files. The procedure is as follows (for other web browsers please read the corresponding manuals):

STEP 1: Click on the "Tools" tab and select the option "Internet Options".

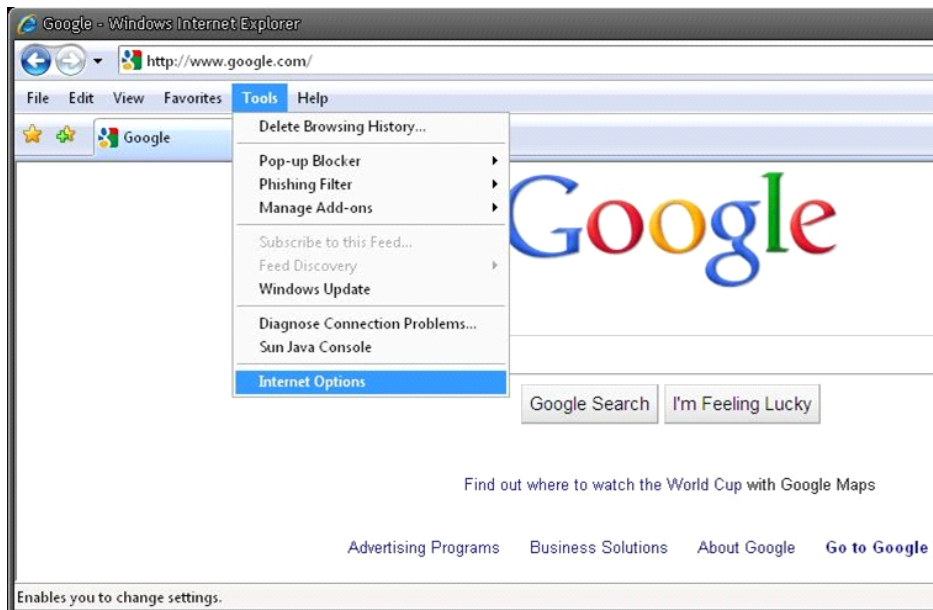

STEP 2: Click on "Delete" in the first pop-up window. Then tap "Delete Files" in the "Temporary Internet files" section in the next pop-up window.

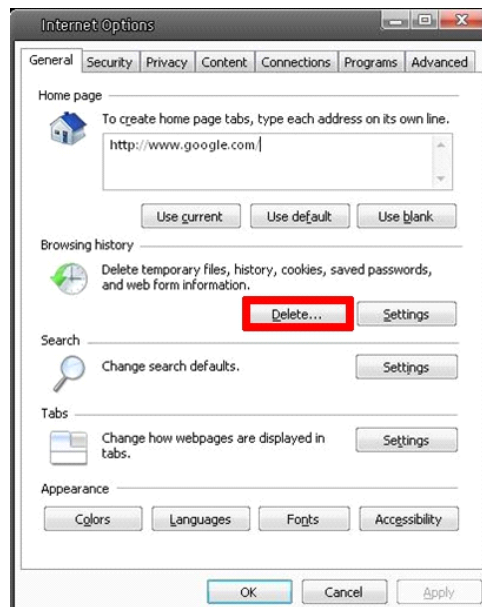

Specifications GCI-K2795P

| | |
|-----------------------------------|--|
| Image Sensor | 1/2.8" CMOS |
| Pixels - Total | 1920(H) x 1080(V) |
| Sensitivity Colour | 0.05 Lux@F1.6 (IRE50) |
| Sensitivity B&W | 0.095 lux @ F1.6 (IRE50) |
| Col/B&W | On/Off/Auto, IR-cut filter removable (ICR) |
| Focal Length | 4.3 ~ 129 mm |
| Viewing Angle | 65.5°(Tele)/3.18°(Wide) |
| Zoom Ratio | x 30 |
| Digital Zoom | 12x |
| Lens Drive Type | DC auto iris, manual iris |
| Iris F-Number | F= 1.6 ~ 360 |
| Focus Adjustment | Auto, Manual |
| Shutter Speed | 1 ~ 1/10,000 sec |
| Pan Speed | Manual: 0.5°/s ~ 90°/s, Preset: 400°/s (max.) |
| Tilt Speed | Manual: 0.5°/s ~ 90°/s, Preset: 400°/s (max.) |
| Range Panning | 360° endless |
| Range Tilting | -10° ~ 190° |
| Number of Preset | 256 |
| Preset Accuracy | 0.225° |
| Number of Pattern | 8 |
| Number of Auto PAN | 4 |
| Number of Cruise | 8 |
| Home position | Preset/Sequence/Auto Pan/Cruise |
| Auto Flip | Image/Mechanic/Off |
| AGC | Auto, Manual |
| WDR | >=96dB |
| White Balance | Auto, Manual, Indoor, Outdoor, ATW |
| Number of Privacy Zones | 16 |
| Motion Detection | On/ Off/ Sensitivity/ 10 Area setting/ by schedule |
| Digital Image Stabilization (DIS) | Off/On |
| Digital Noise Reduction (DNR) | 2DNR/3DNR (Off/On) |
| Alarm Event | Alarm Input, Motion Detection or Schedule: Image transfer or alarm message by FTP, Image transfer or alarm message by E-mail, recording on SD-card and enable alarm output |
| Alarm Inputs | 4 |
| Alarm Outputs | 2 |
| SD memory | supports up to 32 GB capacity of micro SD/SDHC memory |
| Input/Output sockets | Power (Terminal 3-Pin), RJ-45, Micro SD Card Slot, Alarm Terminal (12-Pin Alarm IN/5-Pin, Alarm OUT/7-Pin), Audio IN/OUT (3-Pin Terminal) |
| Network Interface | 1x RJ-45 10/100Mbps |
| Web Browser | MS Internet Explorer 6.0 (or higher), Firefox, Google Chrome, Safari |
| Access protection | By log-in and Password, IP filter, IEEE802.1x |
| Number of Clients | Up to 20 user, 1 x Admin |
| Video Compression | H.264 (MPEG-4Part 10/AVC), MJPEG |
| Video Streaming | Quad stream: 4xH.264 or 3xH.264+MJPEG Triple: 3xH.264 or 2xH.264+MJPEG Dual: 2xH.264 or H.264+MJPEG Single: H.264 or MJPEG |
| Video Resolution | max.:1920x1080(25 fps)+720x576(25fps), 2x1920x1080(13fps), 1280x1024(25fps)+1280x1024(13fps) |
| Network Protocol | IPv4/v6, TCP/IP, UDP, RTP, RTSP, HTTP, HTTPS, DHCP, PPPoE, UPnP, SMTP, ICMP, IGMP, SNMP, IEEE802.1x, QoS, ONVIF, ARP |

| | |
|-----------------------|--|
| Audio Compression | G.711/G.726 ADPCM/AAC |
| Audio Communication | Bi-directional |
| Firmware Upgrade | Firmware upgrade by Web Browser |
| Configuration | Over Web Browser, Upload & Download configuration file |
| Operating Temperature | -40°C ~ +50°C |
| Protection Rating | IP66 / IK10 |
| Regulation | CE, FCC, RoHS Compliant, IP66 |
| Supply Voltage | 24VAC/PoE(IEEE 802.3at 60W) |
| Power Consumption | 50 W |
| Weight | 2.32 kg |
| Dimensions (wxhxd) | Ø192 x 283 mm |

Dimensions

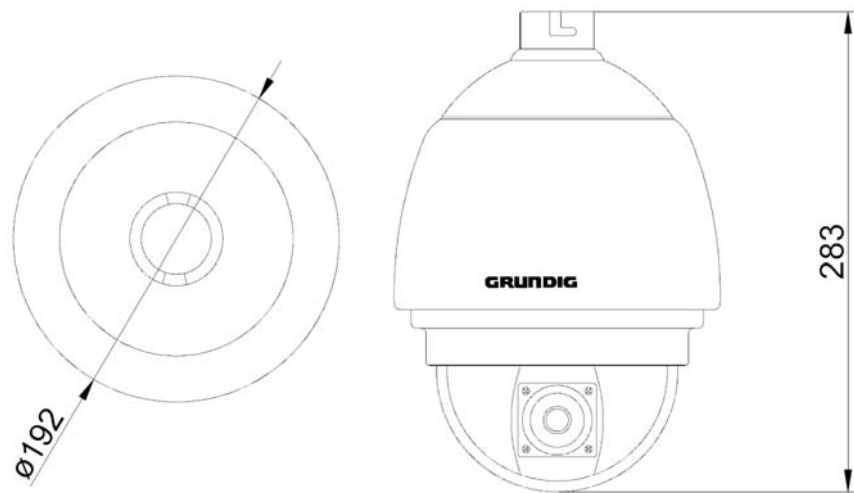

EC Declaration of Conformity



GCI-K2795P 2 MP Full HD Outdoor Motorized Dome IP-Camera 30x Zoom ICR WDR

It is hereby certified that the products meet the standards in the following relevant provisions:

EC EMC Directive 2004/108/EC

Applied harmonised standards and technical specifications:

EN 55022: 2010 (Class A),
EN 61000-3-2: 2006/A1: 2009/A2: 2009, EN 61000-3-3: 2008,
AS/NZS CISPR 22: 2009 (Class A),
EN 50130-4: 1995 / A1: 1998 / A2: 2003,
IEC 61000-4-2: 2008, IEC 61000-4-3: 2010,
IEC 61000-4-4: 2010, IEC 61000-4-5: 2005,
IEC 61000-4-6: 2009, IEC 61000-4-11: 2004,
Mains Supply Voltage Variations

ASP AG

Lüttringhauser Str. 9
42897 Remscheid
Germany

GRUNDIG

Remscheid, 17.07.2014

Ludwig Bergschneider
CEO