



EN

User Manual

**1/2.8" HD-TVI Camera,
Day&Night, 1920x1080, WDR,
2.8-12mm, Infrared, 12/24V**

TVB-2080V2812IR

Safety Precaution

- To prevent fire or shock hazard, do not expose the unit to rain or moisture.
- To prevent electric shocks and risk of fire hazards, do NOT use other than specific power source.

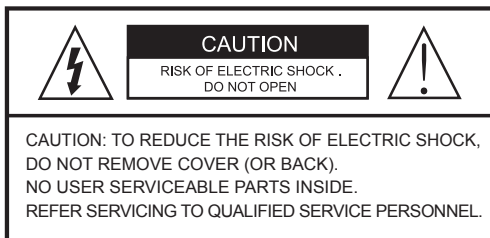

The symbol is intended to alert the user to the presence of uninsulated "dangerous voltage" within the product's enclosure that may be of sufficient magnitude to constitute a risk of electric shock to persons.



The symbol is intended to alert the user to the presence of important operating and maintenance(servicing) instructions in the literature accompanying the unit.

• Warning :

This equipment has been tested and found to comply with the limits for a Class A digital device, pursuant to part 15 of the FCC Rules. These limits are designed to provide reasonable protection against harmful interference when the equipment is operated in a commercial environment. This equipment generates, uses, and can radiate radio frequency energy and, if not installed and used in accordance with the instruction manual, may cause harmful interference to radio communications. Operation of this equipment in a residential area is likely to cause harmful interference in which case the user will be required to correct the interference at his own expense.

• Caution :

Any changes or modifications in construction of this device which are not expressly approved by the party responsible for compliance could void the user's authority to operate the equipment.

Mains power quality should be that of a typical commercial environment. If the user of the model requires continued operation during power mains interruptions, it is recommended that the model be powered from an uninterruptible power supply (UPS) or a battery.

Safety Precaution

NOTICE

- The image used in this instruction manual are processed to help comprehension and may differ from actual video of the camera.
- Avoid installing areas where has shock or vibration which results in the problems.
- Pay attention to safety when laying the connection cable and observe that the cable is not subjected to heavy loads, kinks or damage and no moisture can get in.
- Never open the device such as boards or lens.
The warranty becomes void if repairs are undertaken by unauthorized persons.
- Maintenance and repair have to be carried out only by authorized service centers.
- Use only a mild detergent to clean the housing.
- The camera should never be operated beyond the technical specifications.
This can lead to destruction.
- The camera should never be operated in water.

Contents

p.03~04

Safety Precaution

p.05

Contents

p.06~07

Features

p.07

Composition

p.08

Dimensions

p.09

Part Names

p.10~12

Installation Instructions

p.13~28

Operating Instructions

p.29

Specifications

Features

Key Features

- Full HD, 2Mega Pixel HD-TVI CAMERA, 1920x1080(30p/25p)
- TVI Video Transmission Distance over Coax.; 500M (RG59, 75Ω)
- Automatically removable IR Cut filter by Dual filter switcher
- Built-in f=2.8~12mm F1.4 Mega pixel DC Auto Iris Vari-focal lens
- True WDR(Wide Dynamic Range)
- Improved Noise figure with the enhanced 3D-NR
- Pointing Zoom which enables the flexible zooming at any area.
- Smart Motion Zoom in combining with Pointing Zoom.
(Automatic zoom in/out when motion is detected)
- Preset Zoom
- Motion Detection, Privacy Mask, Defog, Sens-up(x32), D-WDR, H/V/HV Flip, D-Zoom(1.1x~8x), LSC(Lens Shade Compensation), BLC/HLC, Pixel Defect Compensation, Title Set
- Top performance at low light sensitivity (Sens-up On)
- Video output HD-TVI or CVBS switchable
- OSD MENU & Video Sub-out port for easy installation & maintenance
- Circuit protection against faulty connection in power polarity
- Isolated power supply against ground loop problem
- Remote control via RS-485 (Pelco-D/P)
- UTC Control through HD-TVI DVR.
- External Zoom & Focus adjustment
- Built-in 40pcs IR-LEDs
- Dual Window
- One-touch 3-Axis locking bracket, Easy installation pad
- IP67 protection
- AC24/DC12V Dual power

Features

General Description

This camera realizes the natural and crisp image as you see the scene in front of you by Full HD(1920x1080p) camera module.

Highly detailed pictures can be achieved and color reproducibility deserves attention.

- With ICR mechanism,
 - Enhances its sensitivity about 10x at night time
 - Can accept the infrared light
- With Intelligent Focus Indicator and FOCUS ASSIST menu,
 - Offers easy adjustment of Focus
 - Eliminates the mistake of the erratic focus adjustment
- With 24VAC/12VDC dual power design,
 - Offers the flexibility of installation
 - Ensures the reliability

Composition

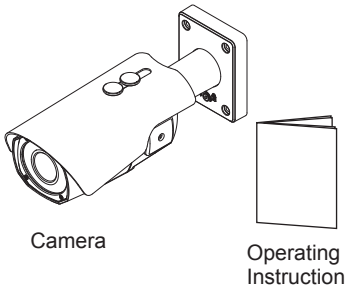

Cable Signal Sticker

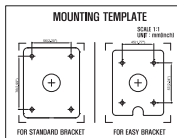

Mounting Template

Plastic Anchor:
6 x 30mm (4pcs)



Mounting Screw:
4 x 30mm (4pcs)



Assembly Screw:
4 x 15mm (4pcs)



Torque Wrench:
3mm (1pc)



Wiring Connector:
(1pc)

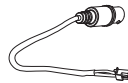

Video Sub-out Cable (1pc)

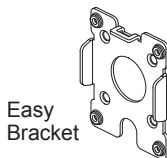

Easy Bracket

Dimensions

(unit : mm)

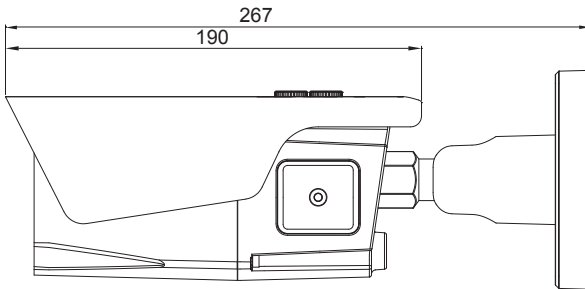
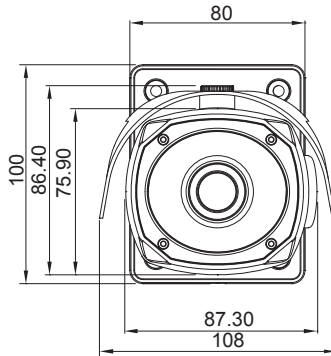

CAUTION

- Extreme care should be taken NOT to scratch the window in front of lens.
- Care should be taken the cable is NOT to be damaged, kinked or exposed in the hazardous area.
- Do not expose the camera directly to a strong light source such as the sun or spot light.

Part Names

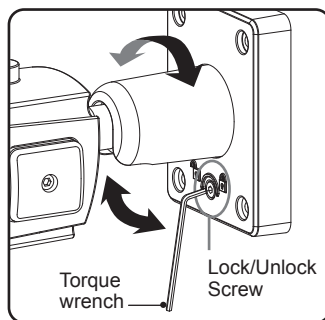
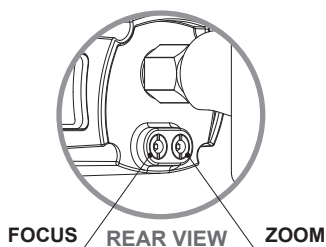
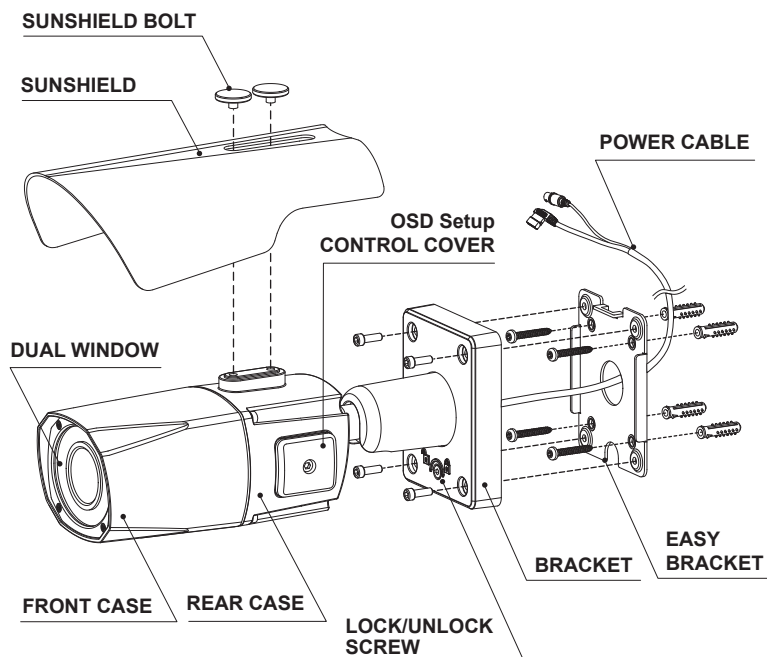

■ Adjustment of viewing angle with a bracket

Installation Instructions

1. Locate the mounting template at the installation position and drill the ceiling or wall if needed. (*The easy bracket can not be installed on the ceiling)
2. Place the easy bracket on pre-drilled position and fix it through using mounting screws (4x30mm). Skip this step when an easy bracket is not installed.
3. Route the Power cable to the connecting place.
Hook up the camera bracket with the easy bracket as illustrated below.
4. Fix the camera bracket through using assembly screws (4x15mm).
5. Set the camera's viewing angle and adjust zoom/focus of lens by using the torque wrench.
6. Put the sunshield to the camera unit and tighten the sunshield-bolts.

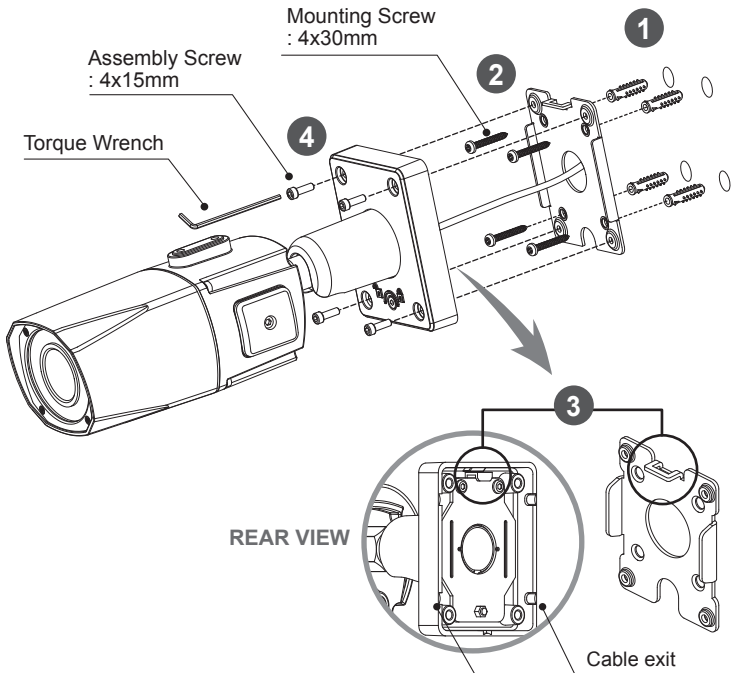

Installation Instructions

Pan & Tilt adjustments

- Unlock the screw on the camera bracket through using the torque wrench supplied
- Set the camera's viewing angle then lock the screw on the bracket.

1) Pan limit:

Pan is limited to +/- 90°.

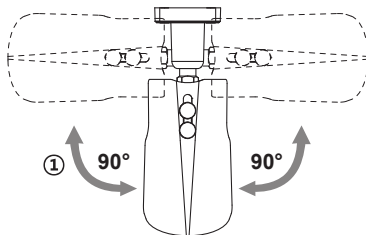

2) Tilt limit:

Tilt is limited to 0°(2°) min ~ 90° max.
for wall(ceiling) installation respectively
with reference to the wall(ceiling) when
the inclination of camera module is 0°,
that is, the image is aligned horizontally.

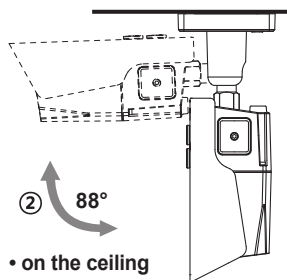
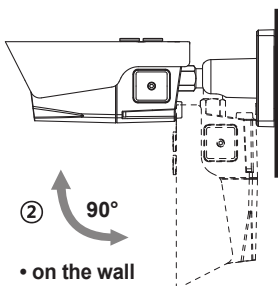

3) Inclination limit

(Horizontal image alignment):
Inclination limited to +/-90° max.

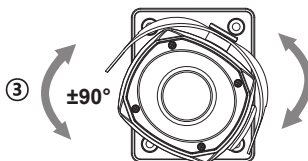

Zoom & Focus adjustments

Use the torque wrench supplied.

- Turn the Focus gear to "N"(Near) or "∞"(Far) until the sharpest focus is made.
- To widen the viewing angle, turn the Zoom to "W"(Wide) and to obtain a closer view, turn it to "T"(Tele)

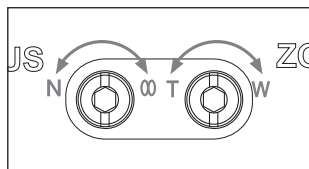

Installation Instructions

Installation and commissioning Instructions

- Make sure the power is removed before the installation.
- Follow the order for applying power.
First, connect the low voltage (AC24V or DC12V), then plug the AC adapter to AC outlets to avoid an improper reset from power jitter and a damage from the surge voltage when no load.

Power Supply Connections

Camera can work with either 24VAC or 12VDC, dual voltage power.
Primary and secondary grounds are completely isolated to avoid the possible ground-loop problems

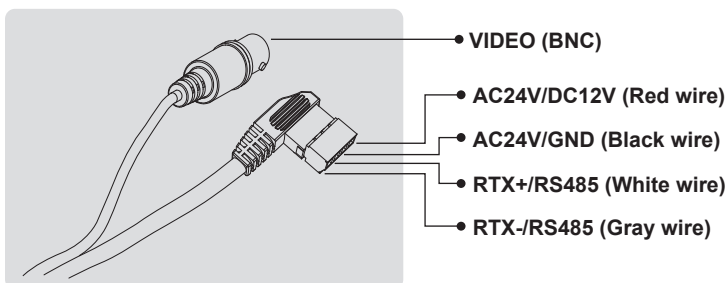

※ Attach the Signal Assignment Sticker in a visible spot for wiring reference.

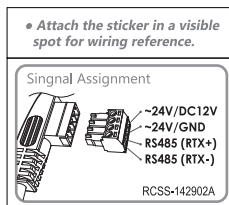

Operating Instructions

Using OSD controller

Setup menu can be accessed and controlled by OSD control joy stick on the side of camera unit. Five commands are available with the joy stick. The design of OSD could be different according to the Model.

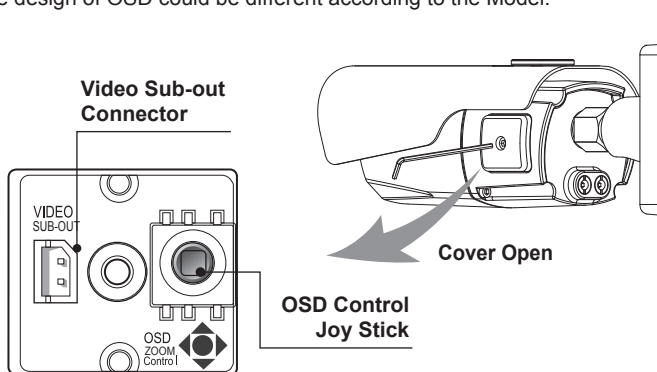

◆ Description of the joystick operation

- 1) SET Key (●) : Access to the menu or enter the setting.
To enter the main menu, press the Set Key down for about 1.5sec
- 2) UP/DOWN Key (▲/▼) : Choose the desired sub-menu and to move the cursor up or down.
- 3) LEFT/RIGHT Key (◀/▶) : Set up the value of the selected menu.
Used to adjust the desired menu selection and to move the cursor left or right.
- 4) '⏏' denotes the long press down straightly for about 2 seconds

◆ Description of the D-ZOOM* adjustment

(*) Works only when OSD menu is inactive.

- 1) ▲ : Zoom In
- 2) ▼ : Zoom Out

◆ Description of Video format switch (HD-TVI ↔ CVBS)

- 1) Default position is TVI.
- 2) Switching the video format : ▲, ▼, ▲, ▼, ● (⏏ long push 1~2 sec.)

Do not power off the camera after switching a video format immediately. It can be cause of crashing a flash memory.

Operating Instructions

OSD menu Startup

Press '●' (OSD menu Joy stick key) down for about 2 seconds to access the setup menu mode.

- RET : Returns to the previous menu.
- EXIT : Exits the menu setting without save.
- SAVE&EXIT : Exits the menu setting with save.

MENU V3.xx	
1. EXPOSURE	↵
2. LENS	DC ↵
3. FOCUS ASSIST	↵
4. SCENE ENHANCE	NORMAL
5. 3D-NR	MID
6. DAY/NIGHT	EXT ↵
7. PICT ADJUST	↵
8. SPECIAL	↵
9. SYSTEM	↵
A. EXIT	SAVE&EXIT ↵

Direct Control menu

MAIN	DEFAULT	DESCRIPTION
EXPOSURE	-	Sets SHUTTER MODE, BRIGHTNESS, SENS-UP and AGC.
LENS	DC	Sets Lens types.
FOCUS ASSIST	-	Sets Focus Adjustments.
SCENE ENHANCE	NORMAL	<p>SCENE ENHANCE provides the several ways to enhance the video in the various environments with the settings in NORMAL, WDR, D-WDR, BLC and HLC.</p> <p>NORMAL – Optimized for the normal indoor and outdoor in the good lighting condition.</p> <p>WDR – Improves the visibility for the high bright area and the dark area by the double captures of image with LONG and SHORT exposures. With WDR ON, the frame rate becomes half by the double captures. WDR level can be selected from LOW, MID and HIGH. Care should be taken to select this mode because video may lose its quality in some environments by the over compensation.</p> <p>※ CVBS video signal: Connecting 2nd video to CVBS port disables WDR function temporary. It should be considered when installer adjusts the video with installation monitor via CVBS video signal.</p>

Operating Instructions

SCENE ENHANCE	NORMAL	<p>D-WDR – Improves the visibility by compensating the video gain for the dark area. Noise can increase in the dark area accordingly.</p> <p>BLC – Improves the visibility for the dark object by the bright back light. Outside area of BLC window can over saturate. BLC has a target window for compensation and its size and position can be set by H-POS, V-POS, H-SIZE and V-SIZE.</p> <p>HLC – Cuts out the highlight area with black mask and excludes it from compensation. Lower HLC LEVEL cut out video from the lower level.</p>
3D-NR	MID	Enables to set OFF, LOW, MID and HIGH.
DAY/NIGHT	<p>EXT for IR LED</p> <p>AUTO for No IR LED</p>	<p>Sets DAY / NIGHT to EXT, AUTO, COLOR and B/W. SMART IR can be set to reduce the saturation by the strong IR illumination in the night in any menu of EXT, AUTO and B/W(NIGHT) Setting SMART IR in any menu is identically applied to other menu. Zero(0) turns off SMART IR and High setting avoids the saturation strongly but the corners will be darker accordingly.</p> <p>IR LED Control(AUTO/OFF) is available with IR LED model only. If IR LED is set to OFF, IR LED will be turned OFF but DAY or NIGHT is still determined by the built-in light photo sensor.</p> <p>EXT – DAY or NIGHT is determined by the built-in light photo sensor. Camera with IR LED must be set to EXT.</p> <p>AUTO – Used when DAY or NIGHT is determined by light level through the lens and DAY from/to NIGHT is switched automatically by the scene brightness.</p> <p>D<->N THRESHOLD, D<->N DELY and SMART IR can be set in the menu. When EXPOSURE>AGC is less than 12, DAY/NIGHT AUTO is disabled and forcibly switches to ___(DAY) to avoid the malfunction. EXT, B/W(NIGHT) and COLOR(DAY) is independent on AGC level. When EXTERNAL IR LED is used with NON IR LED model, please set to IR LED MODE ON.</p> <p>B/W(NIGHT) – Forcibly removes IR cut filter and switches to B/W regardless of light level.</p> <p>COLOR(DAY) – Forcibly DAY/NIGHT is disabled and outputs color video.</p>
PICT ADJUST		Sets WHITE BAL, SHARPNESS, COLOR GAIN, GAMMA, SHADING
SPECIAL		Sets MIRROR/FLIP, PRIVACY, MOTION, PIXEL DEFECT, TITLE SET, DISPLAY, DEFOG, POINTING ZOOM, PRESET ZOOM
SYSTEM		Sets TV SYSTEM, RESOLUTION, COMM.SETUP, UTC CONTROL, LANGUAGE, OUTPUT SELECT and FACTORY DEFAULT
EXIT		<p>SAVE & EXIT – Exits the menu after saving the parameters.</p> <p>EXIT – Exits the menu without saving the menu.</p>

Operating Instructions

1. EXPOSURE

EXPOSURE	
▶ SHUTTER	AUTO
BRIGHTNESS	:.....:..... 10
SENS-UP	OFF
AGC	:.....:..... 12
RETURN	RET ↵

1-1. SHUTTER (default: AUTO)

: Can set SHUTTER MODE to AUTO, MANUAL and Flickerless. MANUAL and Flickerless modes disable SENS-UP functions.

- AUTO: Optimizes the video level by controlling the iris and the shutter speed automatically.
- MANUAL: Iris and Shutter can be set to fix.
- Flickerless : Reduces the flicker in video when US(60Hz)/EU(50Hz) mode is used in 50Hz/60Hz fluorescent lighting respectively.

1-2. BRIGHTNESS (default: 10)

: Adjusts the brightness of video(0~20).

1-3. SENS-UP (default: AUTO)

: The brighter video can be obtained by increasing the exposure time in the night with SENS-UP. SENS-UP is the maximum integrations of frame by DSS (Digital Slow Shutter) in the low light.

- AUTO: SENS-UP is enabled or disabled automatically by the scene brightness. Higher SENS-UP can get the brighter video but the slower frame rates with motion blur and more white pixels. If set to AUTO, maximum integration limit for SENS-UP (Slow Shutter) can be set to x2, x4, X8, x16, X32 in SENS-UP menu.
- OFF: Disables SENS-UP.

1-4. AGC (default: 12)

: AGC(0~20) amplifies the video gain for brighter video but noise and white pixel accordingly.

AGC level less than 10 disables AUTO in DAY/NIGHT.

Operating Instructions

2. LENS

Lens can be selected either DC or MANUAL lens.

Lens MUST be set to DC for the best image when DC iris lens is installed

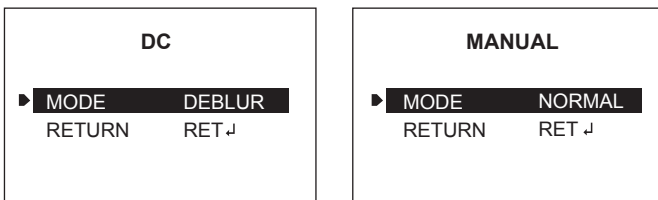

2-1. DC (default: DEBLUR for None LED type)

: Selects lens mode according to installation place. INDOOR or DEBLUR for indoor installation according to environment.

- OUTDOOR: Optimized of outdoor environment.
- INDOOR: Optimized of indoor environment.
- DEBLUR: It enables to reduce the blur in a certain indoor environment. Noise or color rolling can increase.

2-2. MANUAL (default: NORMAL for None LED type)

: Horizontal wave or bar may be seen when MANUAL is selected and the camera is working under florescent or similar lights. Selects NORMAL or DEBLUR.

3. FOCUS ASSIST

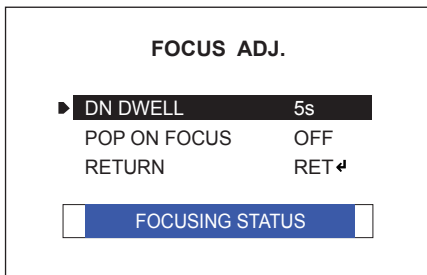

Usually cameras are installed in the day time and they often become OUT OF FOCUS at night time and IN FOCUS again at next day time.

This problem can occur at any cameras regardless of types or manufacturers.

Operating Instructions

FOCUS Adj. menu is the unique and patented feature that prevents from the wrong focus and helps the EXACT NEEDLE focus by simulating DAY & NIGHT conditions.

Set zoom first and adjust focus to get NEEDLE FOCUS while switching at DAY & NIGHT.

- DN DWELL (5s) : ICR switcher switches DAY & NIGHT at the interval of D/N DWELL to help the EXACT NIDDLE focus at DAY and NIGHT mode. Further simulations are performed internally during switching.
- POP ON FOCUS (OFF) : ON zooms in the center of picture at 2X for better focusing.
- FOCUSING STATUS (ON) : Shows how exactly focus is set. When blue bar doesn't show up, try the lens focus to NEAR and FAR. The maximum blue bar indicates the best focusing position.

4. SCENE ENHANCE

: Refer to 'DIRECT CONTROL MENU' table.

MENU V3.xx	
1. EXPOSURE	↵
2. LENS	DC ↵
3. FOCUS ASSIST	↵
▶ 4. SCENE ENHANCE	WDR ↵
5. 3D-NR	MID
6. DAY/NIGHT	EXT ↵
7. PICT ADJUST	↵
8. SPECIAL	↵
9. SYSTEM	↵
A. EXIT	SAVE&EXIT ↵

WDR	
▶ WDR LEVEL	MID
RETURN	RET ↵

- **NORMAL** (default):
Optimized for the normal indoor and outdoor in the normal lighting condition.
- **WDR** : Can be selected from LOW, MID and HIGH
- **D-WDR** : Can be selected from LOW, MID and HIGH
- **BLC** : Can be set the BLC area by H-POS, V-POS, H-SIZE and V-SIZE.
- **HLC** : Can be set the level upto 20

5. 3D-NR (default: MID)

3D-NR is a very sophisticated and powerful time-based noise reduction technology by monitoring the noise for the several video frames and defining and eliminating them consecutively at low light.

Operating Instructions

Higher setting reduces noise much more but results in losing the sharpness and the tail effect or the motion blur for the fast moving target at low light.

6. DAY / NIGHT

: Refer to 'DIRECT CONTROL MENU' table.

Default setting are EXT for IR-LED types and AUTO for None IR LED types.

EXT	
▶ SMART IR	:.....: 0
IR LED CONTROL	AUTO
RETURN	RET ↵



D/N AUTO	
▶ D<->N THRESHOLD	HIGH
D<->N DELAY	10s
SMART IR	:.....: 0
RETURN	RET ↵

7. PICT ADJUST

PICTURE	
▶ WHITE BAL	ATW
SHARPNESS	:.....: 10
COLOR GAIN	:.....: 10
GAMMA	0.50
SHADING	OFF
RETURN	RET ↵

7-1. WHITE BAL (default: ATW)

: ATW, ATWext, ONE PUSH and MANUAL are available for the white balance modes.

- ATW: White balance is continuously working along with the color temperature changes in the range of 2,000K~8,500K.
- ATWext: White balance is continuously working along with the color temperature changes in the range of 1,800K~11,000K.
- ONE PUSH : White balance works only during  is pressed.
- MANUAL: White balance is fixed to the settings by R_GAIN and B-GAIN. This mode can be used only when the color temperature does not vary.

Operating Instructions

7-2. SHARPNESS (default: 10) : Adjusts the sharpness of video(0~20).

7-3. COLOR GAIN (default: 10) : Adjusts the color level of video(0~20).

7-4. GAMMA (default: 0.5) : Adjusts the gamma of video.

7-5. SHADING (default: OFF) :

ON enables to compensate the shade caused by wide lens setting.

8. SPECIAL

SPECIAL	
▶ MIRROR/FLIP	OFF
PRIVACY	↓
MOTION	OFF
PIXEL DEFECT	OFF
TITLE SET	↓
DISPLAY	↓
DEFOG	OFF
POINTING ZOOM	OFF
PRESET ZOOM	OFF
RETURN	RET ↓

8-1. MIRROR/FLIP (default: OFF)

: Reverses the video left and right and/or up and down by MIRROR/FLIP.

- OFF : Normal display without mirroring or flipping
- Hor. : Video is reversed left and right
- Ver. : Video is reversed upside down
- HV : Video is reversed left and right and upside down.

When the video is reversed by Ver. or HV, then the joystick directions are reversed accordingly. This feature is very useful when a camera is installed in upside down.

8-2. PRIVACY

: 10 Privacy zones which can be enabled individually by ZON DISP are available to mask the video.

- PRIVACY ALL: ON enables all Privacy Zones you set.
- ZONE NUM: Set a number to select a privacy zone from 1~10.
- ZONE DISP : ON enables to display relevant privacy zone
- H-POS, V-POS, H-SIZE and V-SIZE : Adjust the size and position of zone
- COLOR : Select the color used for masking the zone form eight colors.
- TRANSPARENCY : Defines the transparency for the mask zone.

Operating Instructions

7-3. MOTION (default: OFF)

: MOTION can detect the changes in the motion window and displays the results in blocks and/or a text message.

- SENSITIVITY : Adjusts the detection sensitivity for motion.

High value increases the sensitivity to detect the small motion easily. Too low sensitivity will cause the erratic detection by the tree leaves or the light level changes.

- H-POS, V-POS, H-SIZE and V-SIZE :

Adjust the size and position of the detection window.

- BLOCK DISP : ON enables to display the blocks for the detected area.

- MOTION OSD : ON enables to display a text message, MOVING !!!,

- SMART MOTION ZOOM : ON enables to Automatic Zoom IN/OUT when motion is detected and also enables MOTION OSD to ON.

Area to be zoomed in by SMART MOTION ZOOM can be set at SPECIAL>

MOTION> SMART MOTION ZOOM. Adjusting ◀, ▶ (Joystick) for ZOOM TARGET varies the viewing angle to be zoomed when the motion

occurs. Set the video left and right and/or up and down by MIRROR/FLIP.

(See page No.26 "SMART MOTION ZOOM")

※ SMART MOTION ZOOM doesn't work at low light condition and BW.

- STAY ZOOMING : Sets the duration time for zooming by Motion.

NOTICE

: SMART MOTION ZOOM does not work at low sensitivity and B/W mode.

CAUTION

: Set the direction of video by MIRROR/FLIP before SMART MOTION ZOOM setting. Otherwise ZOOM TARGET could be different from your intention.

8-4. PIXEL DEFECT (default: OFF)

: Detects and compensates the white pixels which become defective.

Once CALIBRATE is selected, the pixel calibration is initiated with lens closed and can't cancel.

- THRESHOLD : Defines the level of detection and low value detects more pixels. Be sure to set the value so that the pixels are uniformly blinking over the entire screen. Too low value will get the bad results because too many pixels are detected as the bad pixels and the maximum number of pixels for compensation will be filled by the upper area.

Operating Instructions

- EXECUTE '☰' : Long pressing will execute the pixel calibration for the detected pixels. Menu will exit automatically after compensation.

8-5. TITLE SET

: Camera title(name) can be set and edited up to 15 alpha numeric and symbolic characters from ASCII codes(ENGLISH only). ▲, ▼, ◀, ▶ moves the cursor to next input.

Choose a character and ' ' selects it. The selected characters are added and displayed on the top left Corner and the cursor moves right automatically for next input.

- SP - Space is inserted when pressed ' '.
- BS – Cursor moves back when pressed '◀'.
- CLR – Clears all the characters on input line when pressed '●'.
- POS – To be able to set the title position by ▲, ▼, ◀, ▶ and ●.

8-6. DISPLAY

: Enables or disables to display the OSD.

- ID : ON enables to display the camera ID defined by SYSTEM>COMM.SETUP>CAM ID.
- TITLE : ON enables to display the camera title(name) set by SPECIAL>TITLE SET.
- D-ZOOM RATIO : ON enables to display the zoom ratio on the bottom right corner. DZx.x will display by multiplying the actual digital zoom ratio.

8-7. DEFOG (default: OFF)

- AUTO : Enhance the foggy video automatically according to status of scene.
- MANUAL : Sets to enhance the foggy video manually regardless of status of scene.
- LEVEL : LOW, MID, HIGH
Video quality can be less in normal environments.

8-8. POINTING ZOOM

ON enables to set off-centered location to be the center of zoom H-POINTER, V-POINTER- Able to set the location of zoom center D-Zoom is available DZx1.1~x8.0 (See page No.27 "POINTING ZOOM")

8-9. PRESET ZOOM

Able to zoom in for the preset area by PTZ controller.

- ZONE NUM : Set a number to select a preset zoom from 1~ 4.
- ZONE VIEW : ON enables a relevant preset zone.
- H-POS and V-POS : Adjust the size and position of preset zone.

Operating Instructions

- D-ZOOM RATIO: Set the D-Zoom Ratio from DX 1.1~DX5.0
- STAYING ZOOMING : Sets the duration time for preset zoom area.

CAUTION

- Set the direction of video by MIRROR/FLIP before POINTING ZOOM setting. Otherwise location of zoom center could be different from your intention.
- Preset Zoom is available with RS-485 model only.

9. SYSTEM

SYSTEM	
TV SYSTEM	EU(PAL)
RESOLUTION	1080P
COMM. SETUP	↓
UTC CONTROL	AUTO
▶ LANGUAGE	ENG 
OUTPUT SELECT	TVI
FACTORY DEFAULT	NO
RETUTN	RET ↓

9-1. TV SYSTEM (default: US or EU)

- : Selects HDTV standards for US(60HZ) or EU(50HZ). By this selection, 2nd analog video output switches to NTSC or PAL accordingly.

9-2. RESOLUTION (default: 1080P)

- : Three resolutions, 1080P/720P(SCALED)/720P(CROPPED) are available. 1080P outputs 1920x1080 video at the frame rate of 30P/25P.
- 720P(SCALED): Image is scaled down from 1080P and outputs 1280x720 video without loss of field of view at the frame rate of 30P/25P.
- 720P(CROPPED): Image is cropped at the center area from the image sensor and outputs 1280x720 at image refresh rate 30P/25P. Cropped image has narrowed field of view.

9-3. COMM. SETUP

- : COMM. SETUP defines the CAM ID, BAUD RATE and PROTOCOL. Data length, stop bit and parity are fixed to 8bit, 1stop bit and no parity bit.
- CAM ID – Assigns the camera ID from 1~255 for the comm. address.
- BAUD RATE – Selects the baud rate from 2400~115200.
- PROTOCOL – Selects the comm. Protocol from PELCO-D/P or VISCA.

Operating Instructions

9-4. UTC CONTROL (default: AUTO)

: Camera can be adjusted through DVR using Up-the-Coax(UTC) communication with PELCO-C or HIKVISION2 protocols.
Select one of AUTO, PELCO-C, HIKVISION2 or OFF

- AUTO : Camera can detect PELCO-C or HIKVISION2 protocols supported by DVR automatically.
- PELCO-C : Camera can detect PELCO-C protocol only.
- HIKVISION2 – Camera can detect HIKVISION2 protocol only.

[Note]

AUTO supports only to PELCO-C or HIKVISION2 protocols of verified DVRs. If the communication does not work with AUTO well, switch to PELCO-C or HIKVISION2.

9-5. LANGUAGE (default: ENG)

: 8 languages are available for ENGLISH, JAPANESE, GERMAN, FRENCH, ITALIAN, SPANISH, POLISH and TURKISH.

When changing LANGUAGE, select language and press  to load.

9-6. OUTPUT SELECT (default: TVI)

: Selects the video output TVI or CVBS.

[Note]

- Switching the video format : , , , ,  ( long push 1~2 sec.)

Do not power off the camera after switching a video format immediately.

It can be cause of crashing a flash memory.

- If set to CVBS video output, UTC Control setting is switched to OFF

9-7. FACTORY DEFAULT (default: NO)

: RECALL  roads and saves the factory defaults.

A. EXIT













A-1. SAVE&EXIT : Save all the setting and exit the main menu

A-2. EXIT : Exit the main menu without save.

Operating Instructions

TIP

Setting for RS-485 Communication with PTZ Controller (Available with RS-485 model only)

- Enter the MENU :
Press buttons 9+5+PSET (PRESET)  +  + 
- Set the Preset Zoom :
Press buttons 1(or ~4)+PSET (PRESET)  + 
- Move the cursor in the MENU :
Moves UP/DOWN/LEFT/RIGHT Joy stick 
- Select or Choose value in the MENU :
Press button OPEN (IRIS OPEN) 
- D-Zoom IN : Press button TELE 
- D-Zoom OUT : Press button WIDE 
- Exit the Preset Zoom mode :
Press buttons 3+4+PSET (PRESET)  +  + 

Operating Instructions

Detail Function Description

SMART MOTION ZOOM

SMART MOTION ZOOM enlarges the certain area defined by a yellow window to the full sized image when the motion is detected in the black window. SMART MOTION ZOOM window can be re-sized by adjusting D-ZOOM RATIO and moved by H-POINTER and V-POINTER.

UNLIKE the conventional zoom which can zoom in/out the center area of image only, by the flexible zoom location and area, SMART MOTION ZOOM differentiates its usefulness from others.

That is, a conventional camera installed on the corner of ceiling can zoom the center of the floor in a room and result in losing the image of door on the side wall. However, SMART MOTION ZOOM can be set to see the door side and zoom in that area without missing the IMPORTANT security point.

SMART MOTION ZOOM	
H-POINTER	10
V-POINTER	10
D-ZOOM RATIO	MZ2.0
MOTION CHK CUNT	2
RETURN	RET ↓

- H-POINTER (10): Moves MOTION ZOOM area(Yellow window) horizontally.
- V-POINTER (10): Moves MOTION ZOOM area(Yellow window) vertically.
- D-ZOOM RATIO (MZ2.0): Sets the area size to be Digital zoomed when the motion occurs in the black window.
- MOTION CHK COUNT (2) - SMART MOTION ZOOM is activated after the motions in MOTION CHK COUNT are detected in a certain period.
For example, '1' immediately initiates SMART MOTION ZOOM by the motion detected once. High count number enables SMART MOTION ZOOM with suresness but with delay and less sensitivity.

Operating Instructions

POINTING ZOOM

This camera has a very useful and powerful feature, POINTING ZOOM, which can zoom in/out any area.

UNLIKE the conventional zoom which can zoom in/out the center area of image only, by the flexible zoom location and area, POINTING ZOOM differentiates its usefulness from others. That is, a conventional camera installed on the corner of ceiling can zoom the center of the floor in a room and result in losing the image of door on the side wall.

However, POINTING ZOOM can be set to see the door side and zoom in that area without missing the IMPORTANT security point.

POINTING ZOOM can be activated by the joystick operations of ▲ for zoom in and ▼ for zoom out or via web viewer, while SMART MOTION ZOOM is activated by the result of motion detection in the defined area.

If Zoom ratio becomes out of optical zoom ratio, it automatically turns to Digital Zoom.

POINTING ZOOM	
H-POINTER	10
V-POINTER	10
RETURN	RET ↵







- H-POINTER (10): Sets the horizontal location of area to be zoomed by POINTING ZOOM.
- V-POINTER (10) : Sets the vertical location of area to be zoomed by POINTING ZOOM

Operating Instructions

* EXAMPLE OF SMART MOTION & POINTING ZOOM

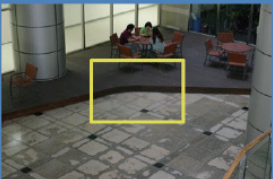
 <p>Just center of picture can be zoomed in.</p>	 <p>We never miss off-centered area.</p>
 <p>Hey!! what's going on???</p>	 <p>We're always with you.</p>

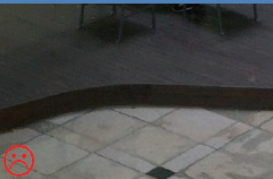
[At the ATM nearby ENTERANCE]

 <p>Just center of picture can be zoomed in.</p>	 <p>Beyond zoom targeting limitation</p>
 <p>Do you really want to check the floor?</p>	 <p>Only available with high-end Technology.</p>

[At the LOBBY]

Specifications

ITEM	TVB-2080V2812IR
Imaging Sensor	1/2.8" Sony Exmor progressive scan CMOS Sensor
Effective Pixels	1920(H) x 1080(V) x 25p
Scan Frequency	25Hz(V), 18.75Khz(H)/ Progressive
Video Format	16:9, 1080p/25
Synchronization	Internal
Video Resolution	1920x1080 (30p/25p)
Min.Illumination	0.0009 Lux @ (LED Off, AGC 12, DSS x2)
S/N Ratio	More than 50dB (AGC Off)
Lens	Built-in f=2.8~12mm F1.4 Mega pixel DC Auto Iris Vari-focal lens
LEDs	Built-in 40pcs x 850nm IR-LED
Exposure	Auto / Manual / Flickerless
DAY / NIGHT	TDN by dual filter switcher, AUTO, COLOR, B/W, EXT
White Balance	ATW / ATWext / One Push / Manual
WDR	True WDR by dual scan images in two frames at 15fps/12.5fps
DNR	3DNR
FLIP	Off, H, V, H/V
Special Features	Intelligent Focusing Indicator on Screen, SMART MOTION ZOOM, POINTING ZOOM, PRESET ZOOM
Functions	NORMAL, WDR, D-WDR, 3DNR, Smart IR, Motion Detection, Privacy Mask, D-Zoom(~8x), Sens-up(x32), Flickerless, BLC/HLC, Defog, Pixel Defect Compensation, Title Set, LSC, Deblur
Remote Control	RS-485(Pelco-D/P), UTC by HD-TVI DVR (Pelco-C, Hikvision)
OSD	English, German, French, Italian, Spanish, Polish, Japanese, Turkish
Video Out	VBS 1Vp-p ± 10%, 75Ω
Installation Temp.	-20°C ~ +50°C (Humidity: 20%RH ~ 80%RH)
Operating Temp.	-30°C ~ +50°C (Humidity: 20%RH ~ 80%RH)
Operating Power	AC24V~10.5VA/DC12V=550mA, 7W Circuit protection against faulty connection in power polarity Isolated power supply against ground loop problem.
Housing	IP67, Aluminum Cast, External Zoom & Focus adjustment, Dual Window, One-touch 3-Axis locking bracket, Easy installation pad
Dimension	108mm(W)x100mm(H)x267mm(L)_with Bracket / About 1.35kg

(*) Design and specifications are subject to change for product improvements without prior notice.



eneo® is a registered trademark of
Videor E. Hartig GmbH
Exclusive distribution through special-
ised trade channels only.

Videor E. Hartig GmbH
Carl-Zeiss-Straße 8
63322 Rödermark/Germany
Tel. +49 (0) 6074 / 888-0
Fax +49 (0) 6074 / 888-100
www.videor.com
www.eneo-security.com

Technical changes reserved

© Copyright by Videor E. Hartig GmbH
Version 10/2015