



PTB-1208F19

Article number: 204426

Thermal Imaging Network Camera, 640x512, 8 Hz, USB, Analogue, 19mm, 32°, 12/24V, PoE

Main features

- Thermal camera with Ethernet and Composite Video out
- 19mm lens
- Exclusive design for indoor and outdoor applications IP67
- Bullet housing for ceiling and wall mounting
- Easy installation, central locking screw
- 3 Years eneo warranty

- Resolution 640x512 Pixel, 8 Hz
- Easy handling, USB and RS-422 remote interface
- Compression standards: H.264/MJPEG
- Covered cabling
- Flexible power supply 12VDC, 24VAC or PoE

Specifications

Series	eneo Candid Medium
System	thermal image
Compression standard	H.264, M-JPEG
Network protocols	HTTP, TCP, UTP, ARP, IPv4, ICMP, RTP, RTSP, PPPoE, SMTP, DHCP, NTP, UPnP, Telnet, FTP
Serial interfaces	RS-422, USB, Ethernet
Remote configuration	web browser, remote software
Image transmission rate max.	8 fps
Alarm inputs	no
Alarm processing	FTP, E-Mail
Privacy zones masking	ON/OFF switchable
Activity detection	yes
Audio support	no

PTB-1208F19

Specifications continued

Menu languages	English
Video outputs	composite (CVBS)
Internal storage	no
Compression standard	H.264, M-JPEG
Stream types	1x H.264, 1x MJPEG simultan
Web browser	MS Internet Explorer vers. 7.0 or higher, Mozilla Firefox (Java), Safari (Java), Google Chrome (Java)
Multicast compliant	yes
Lens type	fixed focal length
Focal length	19 mm
Horizontal angle of view	32 °
Supply voltage	12VDC, 24VAC, PoE
Mounting	wall mount, ceiling mount
Vandalism resistant	no
Housing	outdoor
Housing material	aluminium
Colour (housing)	Pantone 7541
Protection rating	IP67
Integrated wall mount	yes
Hidden cable management	yes
Management Software Support	www.eneo-security.com/en/products/videomanagement.html
SDK	upon request
ONVIF	yes, Profile S
Resolution pixels	640x512
Pixel pitch	17 µm
Spectral area	7,5 - 13,5 µm
Vertical angle of view	26 °
Geometrical Resolution (IFOV)	895 mrad
Thermal sensitivity at 25°C	50 mK
Detection range	640m
Detection range	Man, 1950m, Vehicle
Construction	Bullet housing, Thermal camera
Power consumption	12W
Temperature range (operation)	-35°C ~ +50°C
Weight	1.4 kg
Certificates	CE
Parts supplied	manual, screw set, allen key, mounting plate, Video sub-out cable, USB connection cable

Special features









Built-in pressure valve

More product information

These cameras may not be exported or re-exported outside of Australia, Austria, Belgium, Bulgaria, Canada, Cyprus, Czech Republic, Denmark, Estonia, Finland, France, Germany, Greece, Hungary, Iceland, Ireland, Italy, Japan, Latvia, Lithuania, Luxembourg, Malta, The Netherlands, New Zealand, Norway, Poland, Portugal, Romania, Slovakia, Slovenia, South Africa, South Korea, Spain, Sweden, Switzerland, Turkey, United Kingdom and United States without US Government authorization. These cameras may not be sold, exported, or re-exported to national armed services (army, navy, marine, air force or coast guard), as well as the national guard and national police, government intelligence or reconnaissance organization or any person or entity whose actions or functions or intended to support "military end uses". These commodities, technology or software may not be used in the design, development, production or use of nuclear, chemical or biological weapons or missiles. These commodities may not be sold, transferred or exported to Cuba, Iran, North Korea, Sudan, or Syria.

PTB-1208F19

Available Accessories

Bild	Art. Nr. / Bezeichnung	Beschreibung
	202562 / PNR-5216	Network Video Recorder, 16xIP, 1920x1080, 480fps, 1TB, H.264, MPEG-4, M-JPEG, DVI, D-Sub
	202563 / PNR-5116	Network Video Recorder, 16xIP, 1920x1080, 320fps, 1TB, H.264, MPEG-4, M-JPEG
	202641 / PM-42A	Pole mount adaptor for eneo Candid, Candid S, Candid M Candid L, W3, WB1, AK-5,AK-4
	202888 / AK-4	Camera junction box, for Candid Small ,Candid Medium, Candid Large Series
	203658 / VT-PS12DC-11	Plug-in Power Supply Unit, 100-240VAC/12VDC (1.0A), Regulated, with DC Plug
	204193 / PNR-5104	Network Video Recorder, 4xIP, 1920x1080, 120fps, 1TB, H.264, MPEG-4, M-JPEG
	204192 / PNR-5108	Network Video Recorder, 8xIP, 1920x1080, 200fps, 1TB, H.264, MPEG-4, M-JPEG
	210144 / eneo Scan Device	Management program for eneo IP Cameras

PTB-1208F19

Technical Drawing

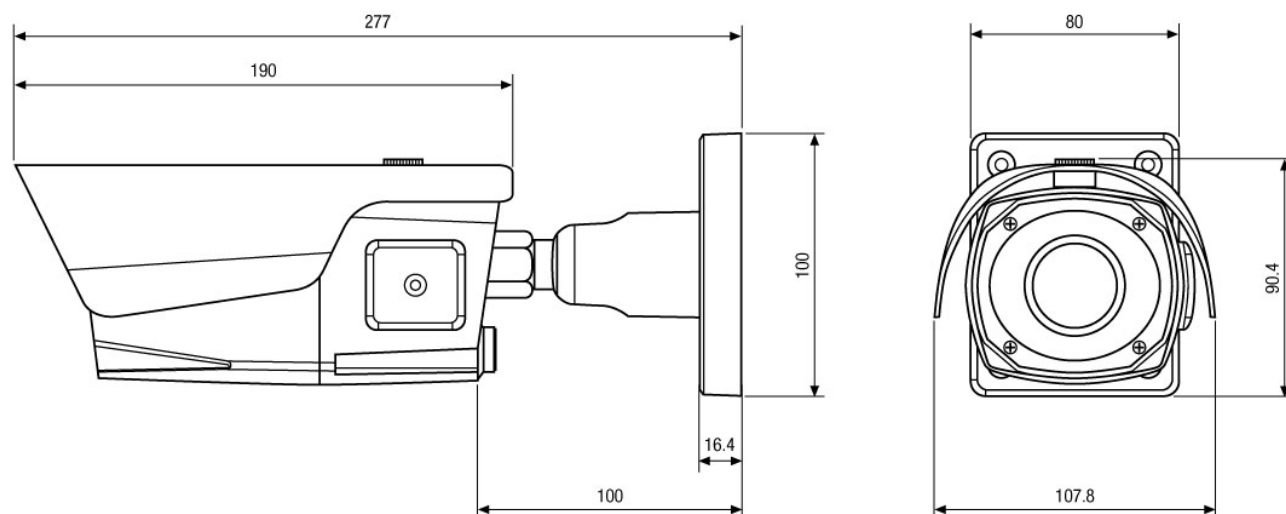

Maße/Dimensions: mm

Your Contact Person



eneo is a registered trademark of
VIDEOR E. Hartig GmbH
Carl-Zeiss-Straße 8
63322 Rödermark
Deutschland
Tel.: +49 6074-888-333
E-Mail: info@eneo-security.com
Web: www.eneo-security.com