

FOR A GOOD **REASON** **GRUNDIG**

en

Owner's Manual

IP Recorders

GRN-G1004P	4 Channel H.264 NVR with PoE switch
GRN-G1116P	16 Channel H.264 NVR with PoE switch
GRN-M1116N	16 Channel H.264 NVR
GRN-M1232N	32 Channel H.264 NVR

GRN-G1116P.171.1.15.10.2015
© ASP AG



Content

1. Introduction.....	6	6. Live View	34
1.1. Available Versions.....	7	6.1. Introduction of the Live View	34
1.2. Key Features of your NVR.....	7	6.2. Operations in Live View Mode.....	35
2. Important Safety Instructions	9	6.2.1. Using the Mouse in Live View	35
3. Package Contents.....	10	6.2.2. Quick Setting Toolbar in Live View Mode.....	36
4. Installation	11	6.3. Adjusting the Live View Settings	38
4.1. Connections and Control Keys.....	11	6.4. Digital Spot	39
4.2. HDD Installation.....	13	7. PTZ Controls.....	39
4.3. Peripheral Connections	15	7.1. Configuring the PTZ Settings	39
5. Getting Started.....	16	7.2. Setting the PTZ Presets, Patrols & Patterns	40
5.1. Operation of the NVR	16	7.2.1. Customising the Presets	40
5.1.1. Remote Control	16	7.2.2. Calling the Presets	41
5.1.2. Troubleshooting the Remote Control.....	18	7.2.3. Customising the Patrols	42
5.1.3. USB Mouse Operation	19	7.2.4. Calling the Patrols	43
5.1.4. Soft Keyboard	20	7.2.5. Customising the Patterns.....	43
5.2. Menu Overview.....	20	7.2.6. Calling the Patterns.....	44
5.3. Starting Up and Shutting Down	20	7.2.7. Customising the Linear Scan Limit...	44
5.4. Setup Wizard for Basic Configuration	22	7.2.8. Calling the Linear Scan	45
5.5. User Login.....	25	7.2.9. One-touch Park.....	45
5.6. User Logout.....	26	7.3. PTZ Control Panel	46
5.7. Menu Operation.....	27	8. Recording Settings.....	47
5.8. Adding and Connecting IP Cameras	27	8.1. Configuring Parameters	47
5.8.1. Add Online IP Cameras	27	8.2. Configuring the Recording Schedule	49
5.8.2. Edit the connected IP Cameras and customised Protocols	30	8.3. Configuring the Motion Detection Recording	52
5.8.3. Edit the IP Cameras Connected to the PoE Built-in Switch	32	8.4. Configuring the Alarm Triggered Recording	53
5.8.4. Checking the PoE Information	33	8.5. Configuring the Manual Recording.....	55
		8.6. Configuring the Holiday Recording.....	55

8.7. Configuring the Redundant Recording (only for GRN-M1116N & GRN-M1232M).....	56	11.6. Triggering or Clearing an Alarm Output Manually	91
8.8. Configuring the HDD Group for Recording	58	12. Network Settings.....	92
8.9. Files Protection.....	59	12.1. Configuring the General Settings	92
9. Playback.....	62	12.2. Configuring the Advanced Settings.....	93
9.1. Playing Back Recording Files.....	62	12.2.1. Configuring the PPPoE Settings	93
9.1.1. Playing Back by Channel.....	62	12.2.2. Configuring the Extranet Access	93
9.1.2. Playing Back by Time	64	12.2.3. Configuring DDNS	93
9.1.3. Playing Back by Event Search.....	65	12.2.4. Configuring the NTP Server.....	95
9.1.4. Playing Back by Tag	67	12.2.5. Configuring SNMP	95
9.1.5. Playing Back by System Logs	69	12.2.6. Configuring the Remote Alarm Host.....	96
9.1.6. Playing Back the External File	71	12.2.7. Configuring Multicast	96
9.2. Auxiliary Functions of Playback.....	71	12.2.8. Configuring RTSP.....	97
9.2.1. Playing Back Frame by Frame.....	71	12.2.9. Configuring the Server and HTTP Ports.....	97
9.2.2. Digital Zoom	73	12.2.10. Configuring Email	98
9.2.3. Reverse the Playback of Multi-channel.....	73	12.2.11. Configuring NAT.....	99
10. Backup	73	12.3. Checking the Network Traffic	103
10.1. Backing up the Recording Files.....	73	12.4. Configuring the Network Detection	103
10.1.1. Backing up by Normal Video Search	73	12.4.1. Testing the Network Delay and Packet Loss.....	103
10.1.2. Backing up by Event Search.....	76	12.4.2. Exporting the Network Packet	104
10.1.3. Backing up Video Clips.....	79	12.4.3. Checking the Network Status	105
10.2. Managing the Backup Devices	80	12.4.4. Checking the Network Statistics ...	105
11. Alarm Settings	83	13. HDD Management.....	106
11.1. Setting the Motion Detection Alarm	83	13.1. Initialising HDDs	106
11.2. Setting the Sensor Alarms.....	85	13.2. Managing the Network HDD.....	108
11.3. Detecting a Video Loss Alarm.....	87	13.3. Managing a HDD Group	109
11.4. Handling an Exceptions Alarm	88	13.3.1. Setting up HDD Groups.....	109
11.5. Setting Alarm Response Actions.....	88	13.3.2. Setting a HDD Property	111

13.4. Configuring the Quota Mode.....	111	15.5.2. Upgrading by FTP	122
13.5. Checking the HDD Status.....	113	15.6. Restoring the Default Settings.....	122
13.6. HDD Detection	114	16. Other Functions.....	123
13.7. Configuring HDD Error Alarms.....	115	16.1. Configuring the RS-232 Serial Port.....	123
14. Camera Settings	116	16.2. Configuring the General Settings	123
14.1. Configuring the OSD Settings	116	16.3. Configuring the DST Settings	124
14.2. Configuring a Privacy Mask	116	16.4. Configuring More Settings for the Device Parameters.....	124
14.3. Configuring Video Parameters	117	16.5. Managing User Accounts.....	124
15. NVR Management	118	16.5.1. Adding a User	125
15.1. Viewing the System Information.....	118	16.5.2. Deleting a User	127
15.2. Searching & Exporting Log Files.....	118	16.5.3. Editing a User.....	128
15.3. Import/Export of Camera Information..	120	17. Glossary.....	129
15.4. Import/Export of Configuration Files.....	121	18. Trouble Shooting	129
15.5. Upgrading the System	121		
15.5.1. Upgrading by a Local Backup Device	121		

1. Introduction

Thank you for purchasing a GRUNDIG network video recorder for IP cameras. This manual is for the recorder models GRN-G1004P, GRN-G1116P, GRN-M1116N and GRN-M1232N.

Before product installation and operation, please become thoroughly familiar with this user manual and other manuals referenced by this manual.

This user manual, the software and the hardware described here are protected by copyright law. With the exception of copying for general use within fair use, copying and reprinting the user manual, either partially or in entirety, or translating it into another language without the consent of ASP AG is strictly prohibited.

This specification may change without prior notice for improvement of product performance.

Product Warranty and Limits of Responsibility:

The manufacturer does not assume any responsibility concerning the sale of this product and does not delegate any right to any third party to take any responsibility on its behalf. No warranty is offered for any attachments or parts not supplied by the manufacturer. The product warranty does not cover cases of accidents, negligence, alteration, misuse or abuse, for example:

- Malfunctions due to negligence by the user
- Deliberate disassembly and replacement by the user
- Connection of a power source other than a properly rated power source
- Malfunctions caused by natural disasters (fire, flood, tidal wave, etc.)
- Replacement of expendable parts (HDD, FAN, etc.)
- Malfunction caused by using an unrecommended HDD
- Malfunction due to HDD failure and not due to a problem in the NVR
- The warranty period for the Fan is one year after purchase.

This product is not for exclusive use of crime prevention but also for assistance in cases of fire. We take no responsibility for damage from any incident.

EU Conformity Statement :

This product and - if applicable - the supplied accessories too are marked with "CE" and comply therefore with the applicable harmonised European standards listed under the Low Voltage Directive 2006/95/EC, the EMC Directive 2004/108/EC, the RoHS Directive 2011/65/EU.

2012/19/EU (WEEE directive): Products marked with this symbol cannot be disposed of as unsorted municipal waste in the European Union. For proper recycling, return this product to your local supplier upon the purchase of equivalent new equipment, or dispose of it at designated collection points.

2006/66/EC (battery directive): This product contains a battery that cannot be disposed of as unsorted municipal waste in the European Union. See the product documentation for specific battery information. The battery is marked with a symbol which may include lettering to indicate cadmium (Cd), lead (Pb), or mercury (Hg). For proper recycling, return the battery to your supplier or to a designated collection point. For more information see: www.recyclethis.info.

Warning:

1. In case of changing the built-in lithium battery, it should be replaced with the same or a kindred one to prevent danger of explosion. Since old batteries could be a factor of environment contamination, be cautious how you treat them.
2. Do not throw the batteries into fire or other heat. Short circuit or disassembly is prohibited.
3. Do not charge the batteries provided with the remote control.

1.1. Available Versions

Model	Channels	SATA Connectors	Incoming Bandwidth	Outgoing Bandwidth	PoE ports
GRN-G1004P	4	1	40 Mbps	80 Mbps	4
GRN-G1116P	16	2	160 Mbps	80 Mbps	8
GRN-M116N	16	4	200 Mbps	160 Mbps	-
GRN-M1232N	32	4	200 Mbps	160 Mbps	-

1.2. Key Features of your NVR

General :

- Connectable to network cameras, network dome and encoders.
- Connectable to third-party network cameras like ACTI, Arecont, AXIS, Bosch, Brickcom, Canon, PANASONIC, Pelco, SAMSUNG, SANYO, SONY, Vivotek and ZAVIO, and cameras that adopt ONVIF or PSIA protocol.
- PAL/NTSC adaptive video inputs.
- Each channel supports dual-stream.
- Up to 16 network cameras can be connected.
- Independent configuration for each channel, including resolution, frame rate, bit rate, image quality, etc.

Local Monitoring :

- Simultaneous HDMI(Trademark) and VGA outputs with up to 1920×1080 resolution.
- Multiple screen display in live view is supported, and the display sequence of channels is adjustable.
- Live view screen can be switched to group view, manual switch and automatic cycle live view are also provided, and the interval of automatic cycle can be adjusted.
- Quick setting menu is provided for live view.
- Motion detection, video tampering, video exception alert and video loss alert functions.
- Privacy masking
- Multiple PTZ protocols supported; PTZ preset, patrol and pattern.
- Zooming in by clicking the mouse and PTZ tracing by dragging the mouse.

HDD Management :

- Supports S.M.A.R.T. and bad sector detection
- 8 network disks (NAS /IP SAN disks) can be connected.
- HDD group management.
- Supports HDD standby function.
- HDD property: redundancy, read-only, read/write (R/W).
- HDD quota management; a different capacity can be assigned to different channels.

Recording and Playback :

- Holiday recording schedule configuration.
- Continuous and event video recording parameters.
- Multiple recording types: manual, continuous, alarm, motion, motion or alarm, motion & alarm
- 8 recording time periods with separated recording types for each day.
- Pre-recording and post-recording for alarm, motion detection for recording, and pre-recording time for schedule and manual recording.
- Searching recording files by events (alarm input/motion detection).
- Tag adding for recording files, searching and playing back by tags.
- Locking and unlocking recording files.
- Local redundant recording.
- Provides a new playback interface with easy and flexible operation.
- Searching and playing back recording files by camera No., recording type, start time, end time, etc.
- Smart search for the selected area in the video.
- Zooming in during playback.
- Reverse playback of multi-channel views.
- Supports pause, play reverse, speed up, speed down, skip forward, and skip backward during playback, and locating by dragging the mouse.
- Up to 16-ch synchronous playback in 4CIF real time.

Backup :

- Exports video data to a USB, SATA or eSATA device. (depending on model).
- Exports video clips during playback.
- Management and maintenance of backup devices.

Alarm and Exception :

- Configurable arming time of alarm input/output.
- Alarm for video loss, motion detection, video tampering, HDD full, HDD error, network disconnected, IP confliction, illegal login, abnormal recording, and PoE power overload (for the models supporting PoE interfaces only), etc.
- Alarm triggers full screen monitoring, audio alarm, notifying surveillance center, sending email and alarm output.
- Automatic restoration when system is abnormal.

Other Local Functions :

- Operable by mouse and remote control.
- Three-level user management; admin user is allowed to create many operating accounts and define their operating permission, which includes the limit to access any channel.
- Operation, alarm, exceptions and log recording and searching.
- Manually triggering and clearing alarms.
- Import and export of device configuration information.

Network Functions :

- 1 self-adaptive 10M/100M/1000M network interface
- 4 independent PoE network interfaces are provided for GRN-G1004P.
- 8 independent PoE network interfaces are provided for GRN-G1116P.
- IPv6 is supported.
- TCP/IP protocol, PPPoE, DHCP, DNS, DDNS, NTP, SADP, SMTP, SNMP, NFS, and iSCSI are supported.
- TCP, UDP and RTP for unicast.
- Auto/Manual port mapping by UPnP(Trademark)
- DDNS support with no-ip.org
- Remote reverse playback via RTSP.
- Support access through the platform via ONVIF.
- Remote search, playback, download, locking and unlocking of the recording files, and breakpoint resume is supported for downloading files.
- Remote parameters setup, remote import/export of device parameters.
- Remote viewing of the device status, system logs and alarm status.
- Remote keyboard operation.
- Remote locking and unlocking of control panel and mouse.
- Remote HDD formatting and program upgrading.
- Remote system restart and shutdown.
- RS-232, RS-485 transparent channel transmission.
- Alarm and exception information can be sent to the remote host
- Remotely starting/stopping the recording.
- Remotely starting/stopping the alarm output.
- Remote PTZ control.
- Remote JPEG capture.
- Two-way audio and voice broadcasting.
- Embedded WEB server.

Development Scalability :

- SDK for Windows and Linux system.
- Source code of application software for demo.

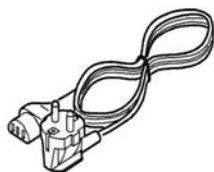
2. Important Safety Instructions

1. Do not place heavy objects on the top of the product.
2. This Product is for indoor use. It is not weatherproof. Please use the product considering its environmental specifications (Temperature & Humidity). To clean the product, gently wipe the outside with a clean dry cloth.
3. This Product uses AC power of 110V ~ 240V. Be cautious not to cause electric damages to the product.
4. Be careful not to drop the product. Physical shocks may harm the product including the internal HDD. In addition, be sure the product is secured after installation.
5. This Product is made of metal. Therefore you can hurt human beings if you throw it to them or hit it on them. When installing the product, be cautious to locate it in safe places where children cannot reach it.
6. If the product does not operate properly, please contact the closest GRUNDIG distributor for after sales service. Tampering or disassembling the product will cause expiration of the warranty.
7. Security surveillance laws may differ for each country. Therefore, please contact the local region first to avoid any surveillance law violations.
8. Experience and technical skills are needed for the installation of this product as an improper installation may cause fire, electric shocks, or defects. Any installation job should be performed by the vendor you purchased this product from.

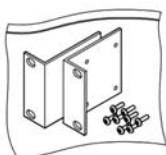
The content of this manual can differ according to firmware or software upgrading. The standard and appearance of the products may be changed for the improvement of quality without prior notice.

3. Package Contents

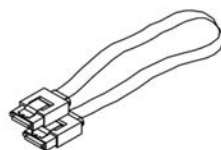
These parts are included:



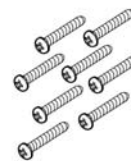
AC Cord



Bracket



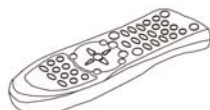
SATA HDD Cable



Screws for HDD



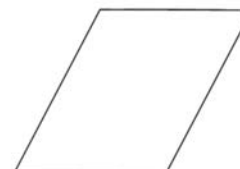
USB Mouse



Remote Control



Setup CD

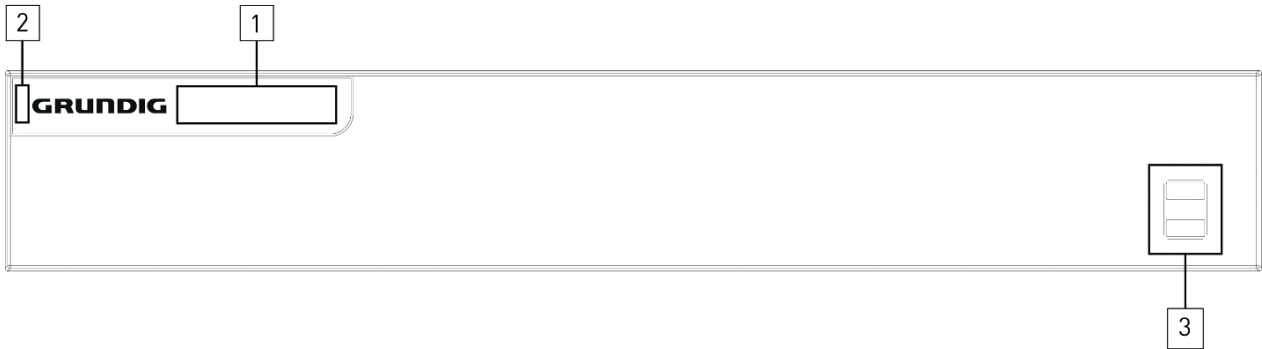


Quick Guide

4. Installation

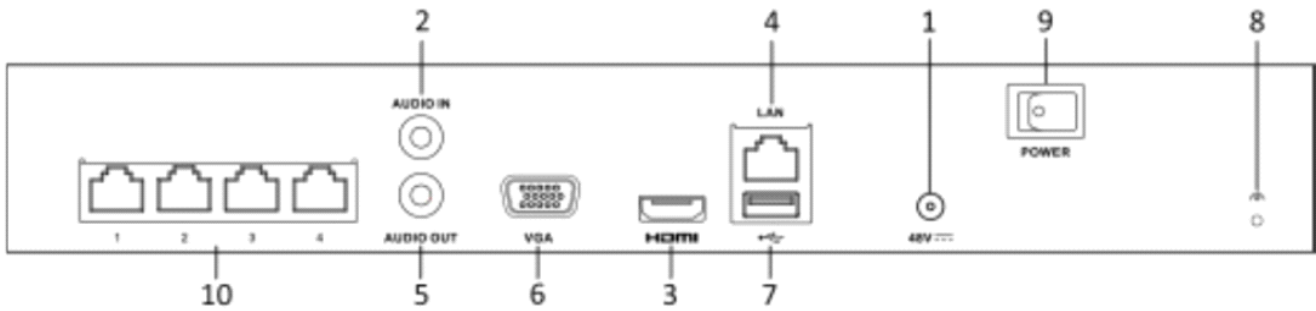
4.1. Connections and Control Keys

Front View:

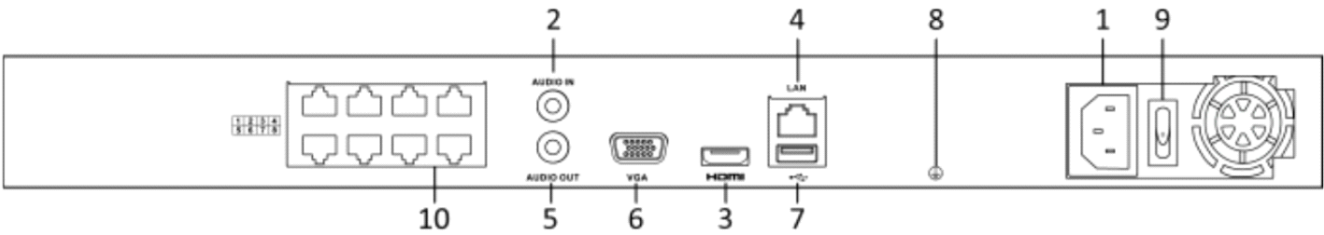


No.	Name	Function Description	
1	Status Indicators	ALARM	Turns red when a sensor alarm is detected.
		READY	Ready indicator is normally blue, indicating that the device is functioning properly.
		STATUS	Turns blue when device is controlled by an IR remote control.
			Turns red when controlled by a keyboard and purple when IR remote control and keyboard is used at the same time.
HDD	Blinks red when data is being read from or written to HDD.		
2	IR Receiver	Receiver for IR remote control	
3	USB Interfaces	Universal Serial Bus (USB) ports for additional devices such as USB mouse and USB Hard Disk Drive (HDD).	

Rear View of the recorder model GRN-G1004P:

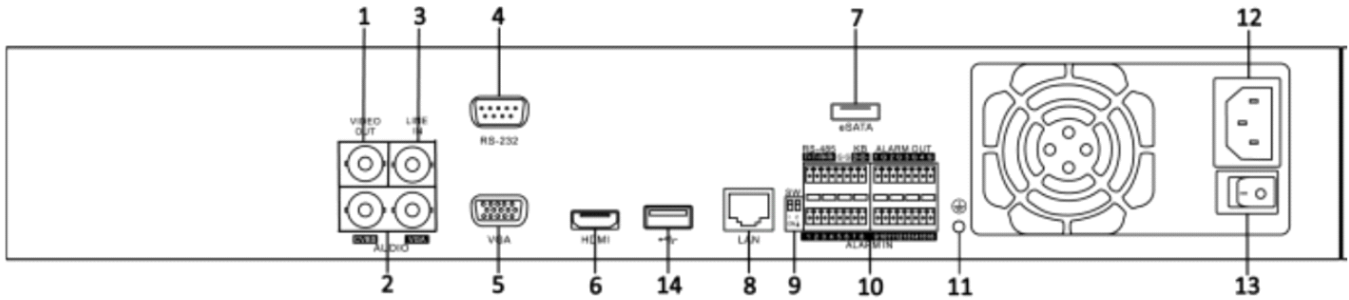


Rear View of the recorder model GRN-G1116P:



No.	Name	Function Description
1	Power	Connect the external power supply here
2	Audio In	Connect a Microphone to this connector
3	HDMI interface	Connect an HDMI monitor to this interface
4	LAN Network Interface	Connect the NVR to the local network
5	Audio Out	Connect a speaker to this connector
6	VGA	Connect an VGA monitor to this interface
7	USB Interfaces	Universal Serial Bus (USB) ports for additional devices such as USB mouse and USB storage for exporting video
8	Ground	Connect the NVR to ground to secure it against high voltage damages
9	Power Switch	Power on/off switch
10	PoE Network interfaces	Connect IP cameras directly to the NVR. * Each PoE port supports the AF ad AT standard.

Rear View of the recorder model GRN-M1116N & GRN-M1232N:



No.	Name	Function Description
1	Video Out	Connect a CVBS Monitor to be used as a Spot Monitor
2	Audio	Audio Outputs for a CVBS and VGA Monitor
3	Line In	Audio Input
4	RS-232 Serial Interface	Connect a keyboard or POS device to this connector
5	VGA	Connect an VGA monitor to this interface
6	HDMI	Connect an HDMI monitor to this interface
7	eSATA	Connect an external eSATA HDD or a SATA HDD rack to expand storage capacity
8	LAN	Connect the NVR to the local network
9	Termination	Terminate signals here
10	Connectors	Connect RS-485 devices, Keyboards, etc. Alarm In and Out connectors
11	Ground	Connect the NVR to ground to secure it against high voltage damages
12	Power	100~240VAC Power Input
13	Power Switch	Power on/off switch
14	USB Interfaces	Universal Serial Bus (USB) ports for additional devices such as USB mouse and USB storage for exporting video

4.2. HDD Installation

Check the settings:

Before installation, please read carefully the recommendations below as high internal temperature of the product can lead to damages and shorten the product's life cycle.

Recommendations on installing a NVR in a rack:

Do not seal the inside of the rack where the NVR is installed. Keep the airflow through the inlet and outlet. If there is another device installed in the rack, secure the additional space or install an air ventilation. Installation of an air circulation fan around each inlet and outlet is strongly recommended. (Install the filter for harmful substances around the inlet or outlet.)

Keep the ambient temperature between 5°C~45°C around the NVR.

Warnings if a HDD is installed:

Please be extra careful not to damage the HDD as it easily breaks.

During installation, make sure the insulated coat does not come off or is not placed in the wrong place. Do not lose screws and parts. (If screws and parts are not screwed or assembled correctly, the product may not operate.) Check the HDD compatibility list.

The Partition table must be removed for the HDDs previously used in a PC or other DVR models before installation.

Before you start:

Disconnect the power from the NVR before installing a hard disk drive (HDD). A factory recommended HDD should be used for this installation.

Up to 8 SATA hard disks can be installed on your NVR.

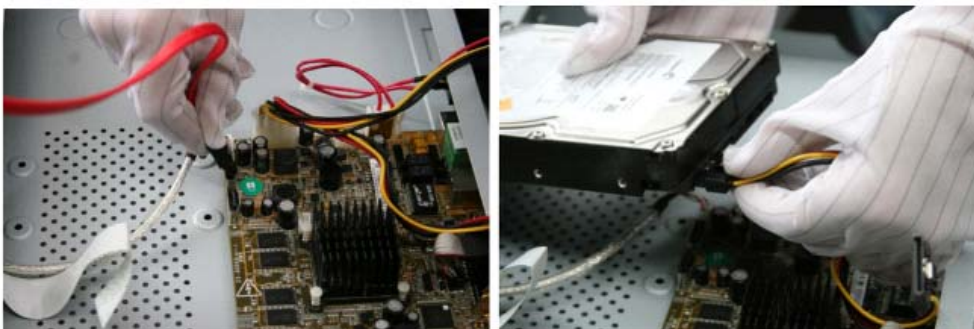
Tools required:

1 Screwdriver.

1. Remove the cover from the NVR by unfastening the screws on the rear and side panel.



2. Connect one end of the data cable to the motherboard of the NVR and the other end to the HDD.



3. Connect the power cable to the HDD.



4. Place the HDD on the bottom of the device and then fasten the screws on the bottom to fix the HDD.

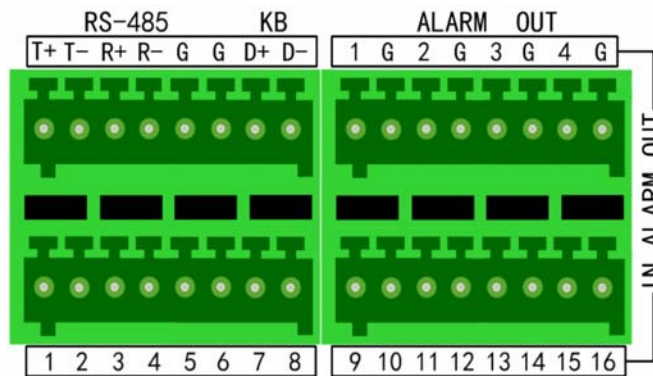


5. Re-install the cover of the NVR and fasten the screws.

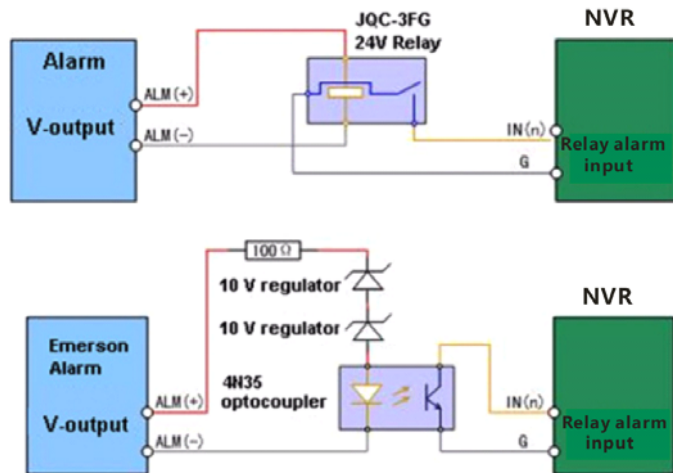
4.3. Peripheral Connections

Instructions on wiring the Alarm Input / Output:

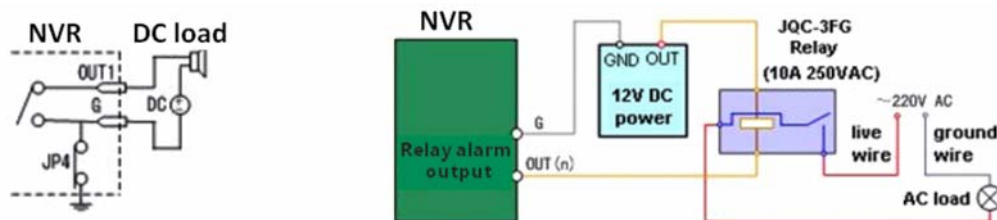
The alarm input/output interface of the NVR is shown as below:



The alarm input is an open/closed relay. If the input is not an open/closed relay, follow the connection diagram below:



To connect to an alarm output (AC or DC load), use the following diagram:



Connections for DC load

Connections for AC load

For DC load, JP4 can be used within the limit of 12V/1A safely. If the interface is connected to an AC load, JP4 should be left open. Use an external relay for safety (as shown in the figure above). There are 4 jumpers (JP1, JP2, JP3, and JP4) on the motherboard, each corresponding with one alarm output. By default, the jumpers are connected. To connect an AC load, the jumpers should be removed.

NOTE: An external relay is needed to prevent electric shock when connecting to an AC load.

Using the Alarm Connectors:

To connect the alarm devices to the NVR:

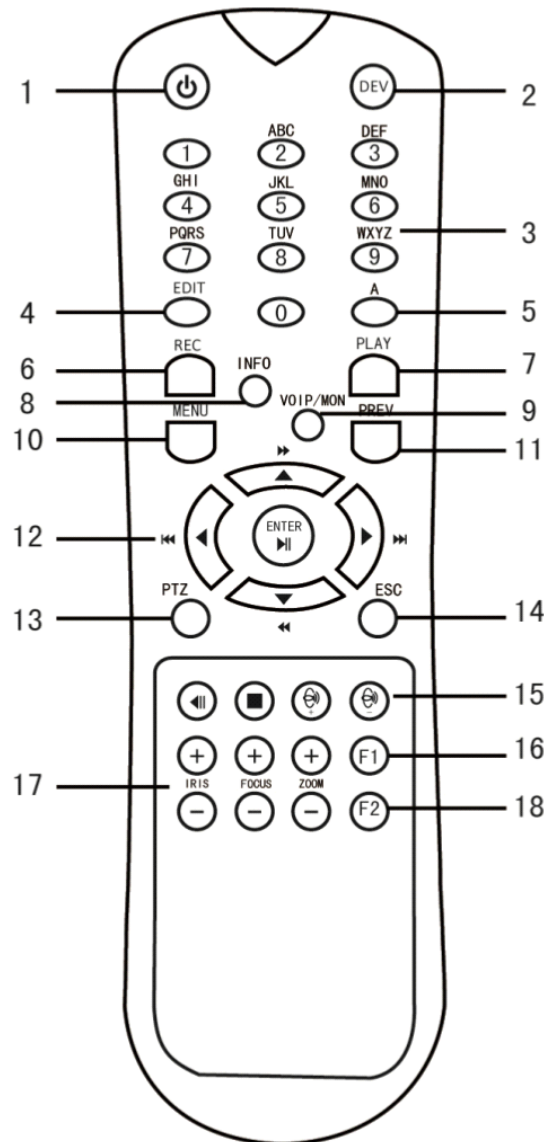
1. Disconnect the pluggable block from the ALARM IN /ALARM OUT terminal block.
2. Unfasten the stop screws from the pluggable block, insert the signal cables into the slots and fasten the stop screws. Ensure that the signal cables are in tightly.
3. Connect the pluggable block back to the terminal block.

5. Getting Started

5.1. Operation of the NVR

5.1.1. Remote Control

It is possible to use all functions of the DVR with the remote control. If several DVRs are set with unique ID numbers, they can be controlled with one remote control.



No.	Name	Description
1	POWER	Power on/off the device.
2	DEV	Enables/Disables the Remote Control.
3	Alphanumeric Buttons	Switch to the corresponding channel in Live view or PTZ Control mode.
		Input numbers and characters in Edit mode.
		Switch between different channels in the Playback mode.
4	EDIT Button	Edit text fields. When editing text fields, it will also function as a Backspace button to delete the character in front of the cursor.
		On checkbox fields, pressing the button will <i>check</i> the checkbox.
		In PTZ Control mode, the button adjusts the iris of the camera.
		In Playback mode, it can be used to generate video clips for backup.
		Enter/exit the folder of the USB device.
5	A Button	Adjust focus in the PTZ Control menu.
		It is also used to switch between input methods (upper and lowercase alphabet, symbols and numeric input).
6	REC Button	Enter the Manual Recording setting menu.
		In the PTZ control settings, press this button and then you can call a PTZ preset by pressing Numeric button.
		It is also used to turn the audio on/off in Playback mode.
7	PLAY Button	This button is used to enter the All-day Playback mode.
		It is also used to auto scan in the PTZ Control menu.
8	INFO Button	Reserved.
9	VOIP Button	Switch between main and spot output.
		In PTZ Control mode, it can be used to zoom out the image.
10	MENU Button	Pressing the button will help you return to the Main menu (after successful login).
		Pressing and holding the button for 5 seconds will turn off the audible key beep.
		In PTZ Control mode, the MENU button will start wiper (if applicable).
		In Playback mode, it is used to show/hide the control interface.

No.	Name	Description
11	PREV Button	Switch between single screen mode and multi-screen mode.
		In PTZ Control mode, it is used to adjust the focus in conjunction with the A/FOCUS+ button.
12	DIRECTION Button	Navigate between different fields and items in menus.
		In the Playback mode, the Up and Down button is used to speed up and slow down the recorded video. The Left and Right button will select the next and previous recording files.
		In Live View mode, these buttons can be used to cycle through channels.
		In PTZ control mode, it can control the movement of the PTZ camera.
	ENTER Button	Confirm the selection in any of the menu modes.
		It can also be used to tick the checkbox fields.
		In Playback mode, it can be used to play or pause the video.
		In single-frame Playback mode, pressing the button will advance the video by a single frame.
13	PTZ Button	In Auto-switch mode, it can be used to stop/start auto switch.
14	ESC Button	Back to the previous menu.
		Press for arming/disarming the device in Live View mode.
15	RESERVED	Reserved for future usage.
16	F1 Button	Select all items on the list when used in a list field.
		In PTZ Control mode, it will turn the PTZ light on/off (if applicable).
17	PTZ Control Buttons	Buttons to adjust the iris, focus and zoom of a PTZ camera.
18	F2 Button	Cycle through tab pages.
		In synchronous playback mode, it is used to switch between the channels.

5.1.2. Troubleshooting the Remote Control

NOTE: Make sure you have installed the batteries properly in the remote control. And you have to aim the remote control at the IR receiver in the front panel.

If there is no response after you press any button on the remote, follow the procedure below to troubleshoot.

Setting the ID of the DVR:

Normally the remote control works out of the box. If the remote control is not working, please set the Remote Control ID as follows:

Remote Control Setup Steps:

1. Go to Menu > Settings > General > More Settings by operating the front control panel or the mouse.
2. Check and remember the NVR ID#. The default ID# is 255. This ID# is valid for all the IR remote controls.
3. Press the DEV button on the remote control.
4. Enter the NVR ID# you set in step 2.
5. Press the ENTER button on the remote.

If the Status indicator on the front panel turns blue, the remote control is operating properly. If the Status indicator does not turn blue and there is still no response from the remote, please check the following:

1. Batteries are installed correctly and the polarities of the batteries are not reversed.
2. Batteries are fresh and not out of charge.
3. IR receiver is not obstructed.

If the remote still cannot function properly, please change the remote and try again, or contact your dealer.

5.1.3. USB Mouse Operation

A regular 3-button (Left/Right/Scroll-wheel) USB mouse can also be used with this NVR.

To use an USB mouse:

1. Plug the USB mouse into one of the USB interfaces on the front panel of the NVR.
2. The mouse should automatically be detected. If in a rare case, the mouse is not detected, the possible reason may be that the two devices are not compatible, please refer to the recommended device list from your provider.

The operation of the mouse:

Name	Action	Description
Left-Click	Single-Click	Live view: Select the channel and show the quick set menu. Menu: Select and enter.
	Double-Click	Live view: Switch between single-screen and multi-screen.
	Click and Drag	PTZ control: pan, tilt and zoom. Video tampering, privacy mask and motion detection: Select a target area. Digital zoom-in: Drag and select the target area. Live view: Drag channel/time bar.
Right-Click	Single-Click	Live view: Show menu. Menu: Exit the current menu to go to the upper level menu.
Scroll-Wheel	Scrolling up	Live view: Previous screen. Menu: Previous item.
	Scrolling down	Live view: Next screen. Menu: Next item.

5.1.4. Soft Keyboard

Overview over the Soft Keyboard:



Description of the buttons on the Soft Keyboard:

Icons	Description	Icons	Description
	Lowercase/Uppercase		Symbols
	Space		Backspace
	Exit		Enter

5.2. Menu Overview

After entering the menu, the menu bar on the top of the screen can be clicked on to set other functions. From the left to the right, the icon stand for Playback, Export, Manual, HDD, Record, Camera, Configuration, Maintenance and Shutdown. And the current submenu you are in is marked in light green.



5.3. Starting Up and Shutting Down

Proper startup and shutdown procedures are crucial to expanding the life of the NVR.

Before you start:

Check that the voltage of the extra power supply is the same as the NVR's requirement, and the ground connection is working properly.

Starting up the NVR:

Steps:

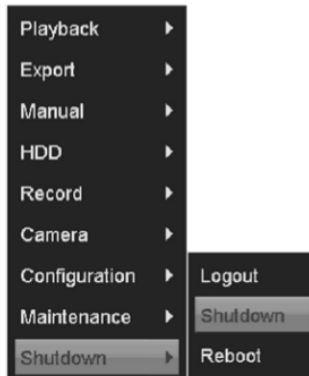
1. Check whether the power supply is plugged into an electrical outlet. It is HIGHLY recommended that an Uninterruptible Power Supply (UPS) is used in conjunction with the device. The Power indicator LED on the front panel should be red, indicating the device gets the power supply.
2. Turn on the power switch on the rear panel if the device starts up for the first time, or press the "Standby" button on the front panel. The Power indicator LED should turn blue indicating that the unit begins to start up.
3. After startup, the Power indicator LED remains blue. A splash screen with the status of the HDD appears on the monitor. The row of icons at the bottom of the screen shows the HDD status. 'X' means that the HDD is not installed or cannot be detected.

Shutting down the NVR:

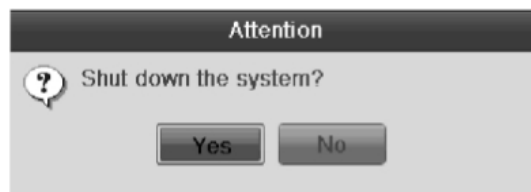
There are two proper ways to shut down the NVR.

Steps:

1. Enter the Shutdown menu: Menu> Shutdown

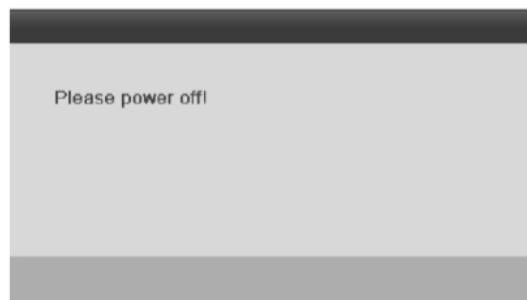


2. Click on the "Shutdown" button.



3. Click the "Yes" button.

4. Turn off the power switch on the rear panel when the attention window pops up.



Rebooting the NVR:

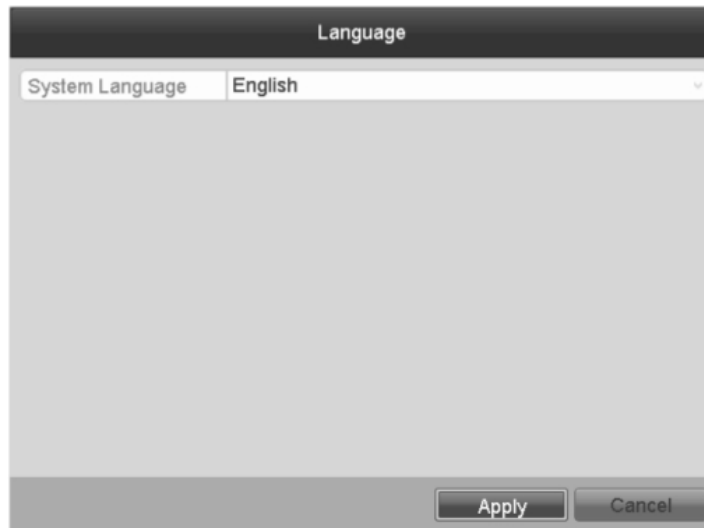
In the Shutdown menu, you can also reboot the NVR.

Steps:

1. Enter the "Shutdown" menu by clicking Menu> Shutdown.
2. Click on the "Logout" button to lock the NVR or the "Reboot" button to reboot the NVR.

5.4. Setup Wizard for Basic Configuration

By default, the Setup Wizard starts once the NVR has loaded.



Operating the Setup Wizard:

1. The Setup Wizard can take you through some important settings of the NVR. If you do not want to use the Setup Wizard at that moment, click the "Cancel" button. You can also choose to use the Setup Wizard next time by leaving the "Start wizard when the device starts?" checkbox checked.



2. Click the "Next" button on the Wizard window to enter the Login window.



3. Enter the admin password. By default, the password is 1234.
4. To change the admin password, check the "New Admin Password" checkbox. Enter the new password and confirm the password in the given fields.
5. Click the "Next" button to enter the date and time settings window.

The screenshot shows a window titled "Wizard" with the following settings:

Time Zone	(GMT +01:00) Amsterdam, Berlin, Rome, Paris
Date Format	DD-MM-YYYY
System Date	08-08-2013
System Time	08:52:28

At the bottom of the window, there are three buttons: "Previous", "Next", and "Exit".

6. After the time settings, click the "Next" button which takes you back to the Network Setup Wizard window, as shown below.

The screenshot shows a window titled "Wizard" with the following settings:

NIC Type	10M/100M/1000M Self-adaptive
Enable DHCP	<input type="checkbox"/>
IPv4 Address	172 .6 .23 .11
IPv4 Subnet Mask	255 .255 .255 .0
IPv4 Default Gateway	172 .6 .23 .1
Preferred DNS Serv...	
Alternate DNS Server	

At the bottom of the window, there are three buttons: "Previous", "Next", and "Exit".

The screenshot shows a window titled "Wizard" with the following settings:

NIC Type	10M/100M/1000M Self-adaptive
Enable DHCP	<input type="checkbox"/>
IPv4 Address	172 .6 .23 .190
IPv4 Subnet Mask	255 .255 .255 .0
IPv4 Default Gateway	172 .6 .23 .1
Preferred DNS Serv...	
Alternate DNS Server	
Internal NIC IPv4 Ad...	192 .168 .254 .1

At the bottom of the window, there are three buttons: "Previous", "Next", and "Exit".

NOTE: For the models which have the PoE or built-in switch network interfaces, the internal NIC IPv4 address should be configured for the cameras connecting to the PoE or built-in switch network interface of the NVR.

7. Click the „Next“ button after you configured the network parameters, which takes you to the HDD Management window.



8. To initialise the HDD, click the "Init" button. Initialisation removes all the data saved in the HDD.

9. Click the "Next" button. You enter the Adding IP Camera interface.

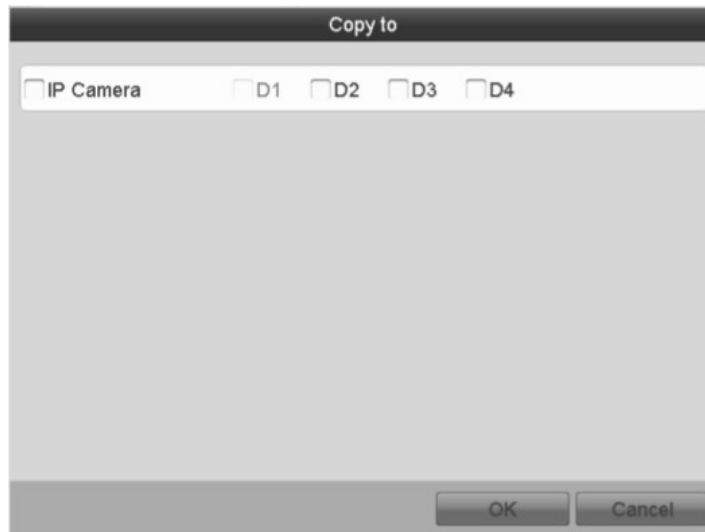
10. Click "Search" to find an online IP Camera. Select the IP camera to be added, and click the "Add" button.



11. Click the "Next" button. Configure the recording for the searched IP Cameras.



12. Click "Copy" to copy the settings to other channels.



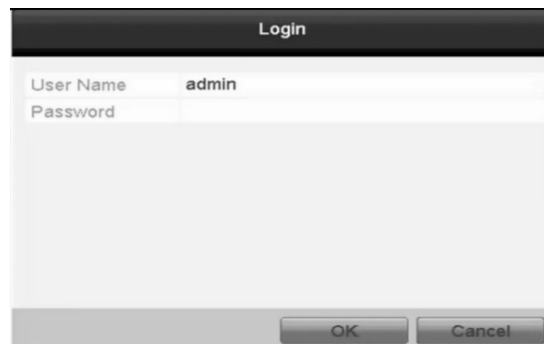
13. Click "OK" to complete the startup Setup Wizard.

5.5. User Login

To control any function of the NVR/DVR, you must login the device before operating the menu and other functions.

Steps:

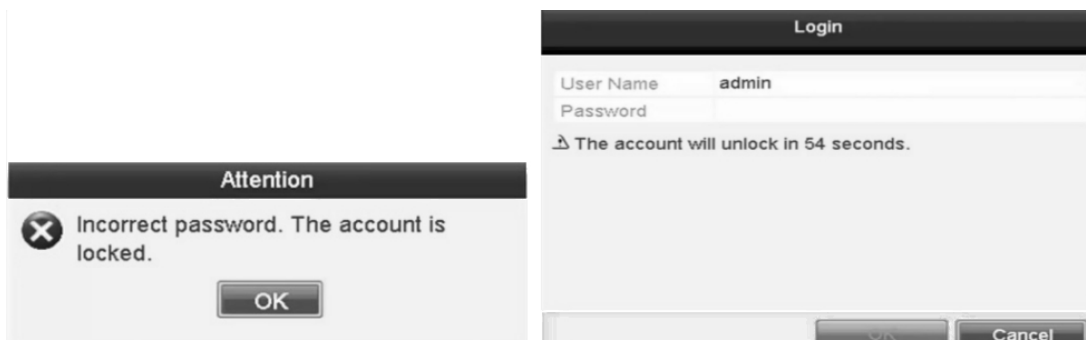
1. Select the User Name in the dropdown list.



2. Input the Password.

3. Click OK to log in.

In the Login dialogue box, if you have entered the wrong password for 7 times, the current user account will be locked for 60 seconds.

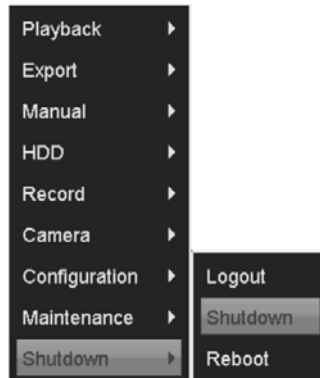


5.6. User Logout

After logging out, the monitor turns to the live view mode and if you want to make a setting or do some other operation, you need to enter the user name and password again.

Steps:

1. Enter the Shutdown menu: Menu> Shutdown



2. Click "Logout".

NOTE: After you have logged out of the system, the menu operation on the screen will be invalid. It is required to input a user name and password to unlock the system.

5.6.3. Edit the IP Cameras Connected to the PoE Built-in Switch

NOTE: The cameras connecting to the PoE interface cannot be deleted in this menu.

2. Click the "[open on a written sheet]" button, and select the Adding Method in the drop-down list.

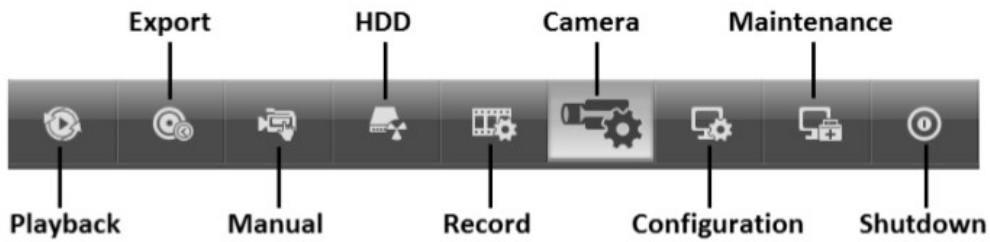
- Plug-and-Play: It means that the camera is connected to the PoE interface, so in this case, the parameters of the camera cannot be edited. The IP address of the camera can only be edited in the Network Configuration interface, see Chapter "9.1 Configuring the General Settings" for detailed information.

Edit IP Camera	
IP Camera No.	D1
Adding Method	Plug-and-Play
IP Camera Address	192.168.254.2
Protocol	
Management Port	8000
Channel Port	1
User Name	admin
Admin Password	

OK Cancel

5.7. Menu Operation

After entering the local operation interface of the device, the main menu bar will be displayed on the top of the screen. You can click on the icons to enter the corresponding submenus and perform the operations.



The icon of the current submenu is marked in light green.

To exit from the main menu bar, right-click on the screen and you will go back to the live view interface.

5.8. Adding and Connecting IP Cameras

5.8.1. Add Online IP Cameras

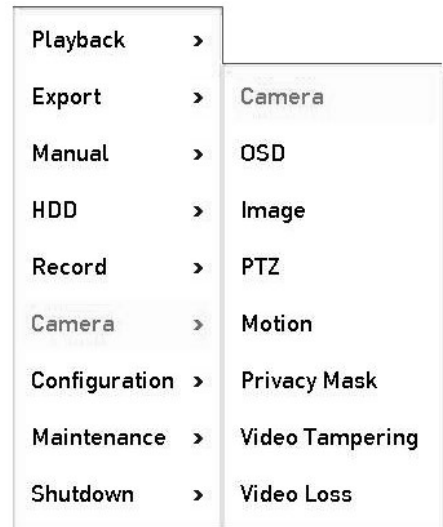
The main function of the NVR is to connect the network cameras and recording the video received from them. So before you can get a live view or recording of the video, you should add the network cameras to the connection list of the device.

Before you start:

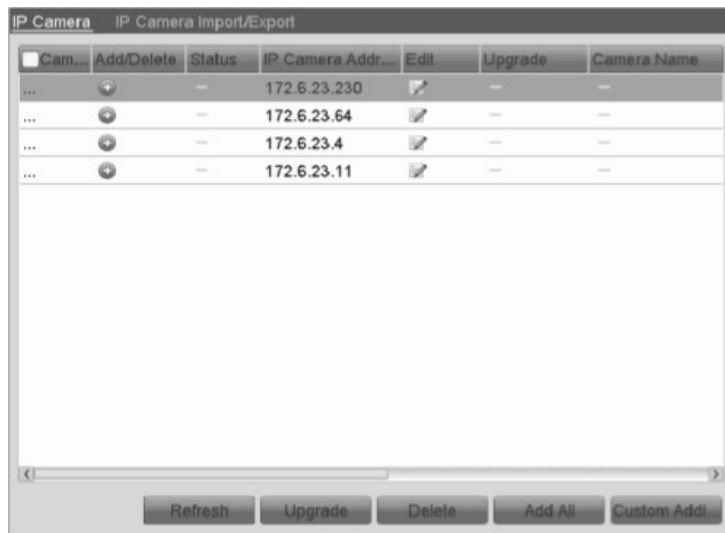
Ensure the network connection is valid and correct. For detailed checking and configuring of the network, please see Chapter 9.3 "Checking Network Traffic" and the Chapter "Configuring Network Detection".

Steps:

1. Enter the Camera Management interface: Menu > Camera > Camera



2. Select "Add IP Camera" in the pop-up menu to enter the IP Camera Management interface.



3. The online cameras with the same network segment will be displayed in the camera list. Click the "+" button to add the camera.

4. To add other IP cameras:

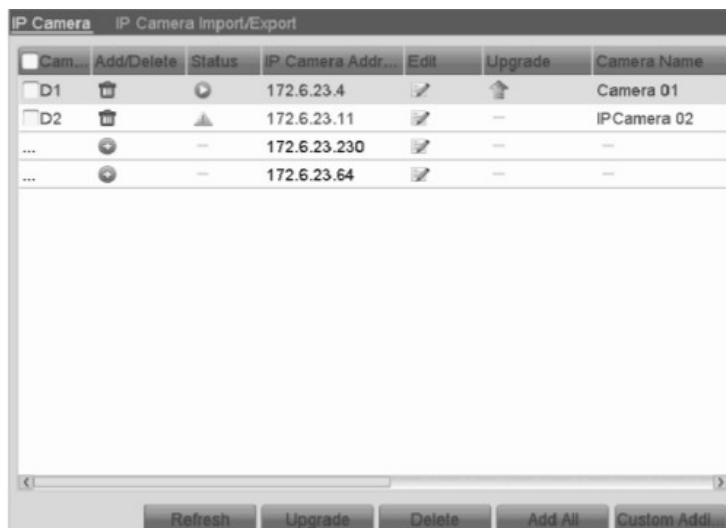
1) Click the "Custom Adding" button to pop up the "Add IP Camera (Custom)" interface.









2) You can edit the IP address, protocol, management port, and other information of the IP camera to be added.

3) Click "Add" to add the camera.

4) The successfully added IP cameras are listed in the interface:



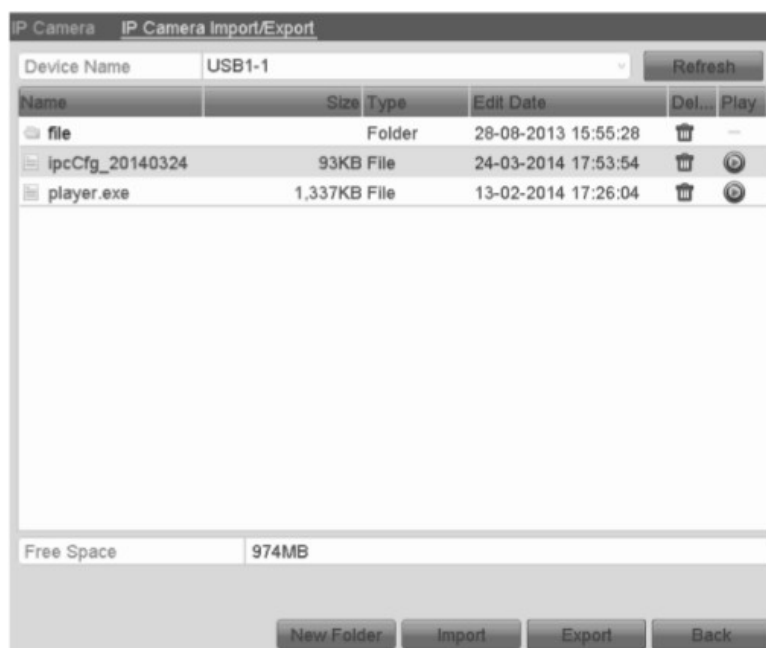
Icon	Explanation	Icon	Explanation
	Edit basic parameters of the camera		Add the detected IP camera.
	The camera is connected.		The camera is disconnected; you can click on the icon to get the exception information of the camera.
	Advanced settings of the camera.		Delete the IP camera

5. Import/Export the configuration file of the IP cameras.

Import the configuration file of the IP cameras to the device:

Connect the backup device on which the configuration file is stored.

1) Click on the "IP Camera Import/Export" tab.



2) Select the backup device from the drop-down list and click the "Refresh" button to get the latest information of the backup device.

3) Select the configuration file of the IP camera from the list.

4) Click the "Import" button to import the IP cameras to the device.

5) Click "OK" on the pop-up message box after the importing process is complete. The imported IP cameras will be displayed on the IP Camera Management interface.

Export the configuration file of the IP cameras to the backup device:

Connect the backup device on which the configuration file is stored to the device.

1) Click on the "IP Camera Import/Export" tab.

2) Select the backup device from the drop-down list. You can click the "Refresh" button to get the latest information of the backup device.

3) Click the "Export" button to export the configuration file of the IP cameras to the backup device.

4) Click "OK" on the pop-up message box after the exporting process is complete. The configuration file of the IP cameras will be displayed in a list.

5.8.2. Edit the connected IP Cameras and customised Protocols

After the adding of the IP cameras, the basic information of the camera lists in the page, and you can configure here the basic settings of the IP cameras.

Steps:

1. Click the “(Pen on a written sheet)” icon to edit the parameters. Here you can edit the IP address, protocol and other parameters.




Edit IP Camera	
IP Camera No.	D1
IP Camera Address	10.16.1.243
Protocol	
Management Port	8000
Channel Port	1
User Name	admin
Admin Password	

2. Click “OK” to save the settings and exit the editing interface.

To edit the advanced parameters:

Steps:

1. Drag the horizontal scroll bar to the right side and click the “(cogwheel on a written sheet)” icon.



Advance Set	
Network Password	
IP Camera No.	D1
IP Camera Address	10.16.1.243
Management Port	8000

2. You can edit the network information and the password of the camera.

The screenshot shows a dialog box titled "Advance Set" with a "Password" tab selected. The dialog contains a table with the following fields:

Field	Value
IP Camera No.	D1
Current Password	
New Password	
Confirm	

At the bottom of the dialog, there are three buttons: "Apply", "OK", and "Cancel".

3. Click "Apply" to save the settings and click "OK" to exit the interface.

Configuring the customised protocols:

To connect network cameras which are not using the implemented protocols, you can configure the customised protocols to enable them to be used with the Grundig NVRs.

Steps:

1. Click the "Protocol" button in the custom adding IP camera interface to enter the protocol management interface.

The screenshot shows a dialog box titled "Protocol Management". It contains a table with the following fields:

Field	Value	
Custom Protocol	Custom Protocol 1	
Protocol Name	Custom 1	
Stream Type	Main Stream	Substream
Enable Substream		<input checked="" type="checkbox"/>
Type	RTSP	RTSP
Transfer Protocol	Auto	Auto
Port	554	554
Path		

Below the table, there is an example URL: `Example: [Type]://[IP Address]:[Port]/[Path]`
`rtsp://192.168.0.1:554/ch1/main/av_stream`

At the bottom of the dialog, there are three buttons: "Apply", "OK", and "Cancel".

There are 16 customised protocols provided in the system, where you can edit the protocol name and choose whether to enable the sub-stream.

2. Choose the protocol type of transmission and choose the transfer protocols.

NOTE: Before customising the protocol for the network camera, you have to contact the manufacturer of the network camera to consult the URL (uniform resource locator) for getting main stream and sub-stream.

The format of the URL is: [Type]://[IP Address of the network camera]:[Port]/[Path].

Example: `rtsp://192.168.1.55:554/ch1/main/av_stream`.

- Protocol Name: Edit the name for the custom protocol.
- Enable Substream: If the network camera does not support sub-stream or the sub-stream is not needed, leave the checkbox empty.
- Type: The network camera adopting the custom protocol must support getting stream through a standard RTSP.
- Transfer Protocol: Select the transfer protocol for the custom protocol.
- Port: Set the port No. For the custom protocol.
- Path: Set the resource path for the custom protocol. E.g., ch1/main/av_stream.

NOTE: The protocol type and the transfer protocols must be supported by the connected network camera. After adding the customised protocols, you can see that the protocol name is listed in the dropdown list.



3. Choose the protocols you just added to validate the connection of the network camera.

5.8.3. Edit the IP Cameras Connected to the PoE Built-in Switch

This section is applicable to GRN-G1004P & GRN-G1116P models only.

As the adding camera steps for the built-in switch are the same as the ones for the PoE interfaces, we take the instruction of connecting to the network cameras via the PoE interface as an example.

The PoE interfaces enable the NVR system to pass on electrical power safely, along with data, on Ethernet cabling to the connected network cameras.

The NVR which supports the PoE function can connect to the network cameras directly via the PoE interfaces. And if you disable the PoE interface, you can also connect to the online network cameras.

Example:

If you want to connect 2 online cameras and connect 6 network cameras via PoE interfaces to a GRN-G1116P, you must disable 2 PoE interfaces in the "Edit IP Camera" menu.

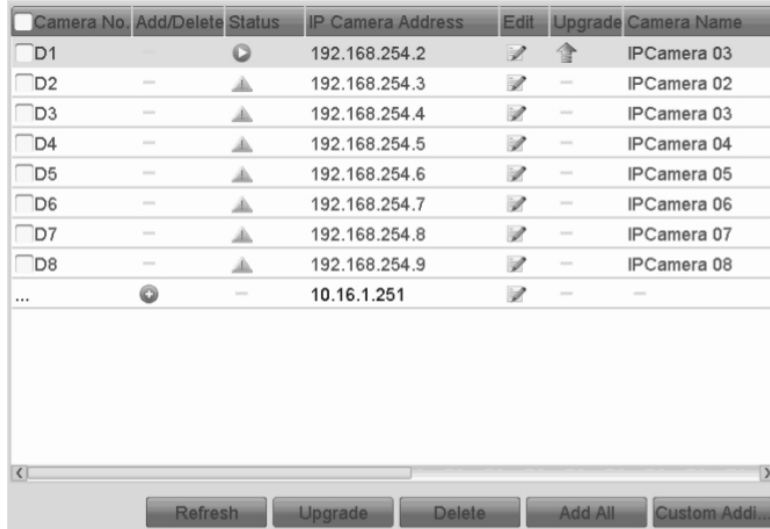
Adding Cameras for an NVR supporting the PoE Function:

Before you start:

Connect the network cameras via the PoE interfaces.

Steps:

1. Enter the Camera Management interface: Menu> Camera> Camera

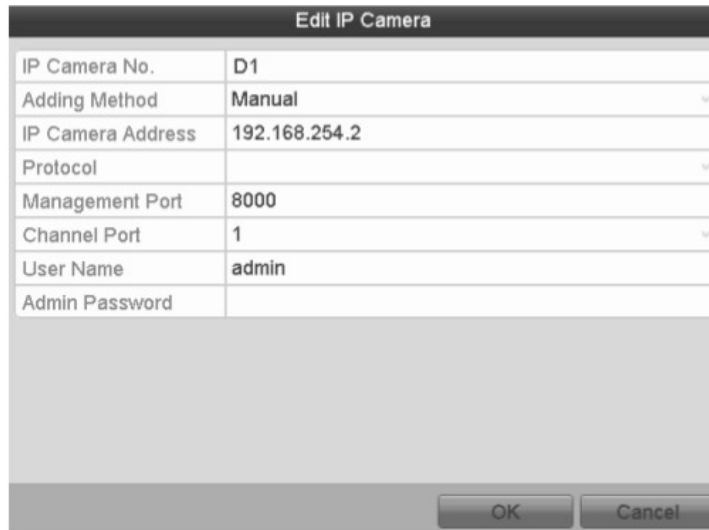


Camera No.	Add/Delete	Status	IP Camera Address	Edit	Upgrade	Camera Name
<input type="checkbox"/> D1	--		192.168.254.2			IPCamera 03
<input type="checkbox"/> D2	--		192.168.254.3		--	IPCamera 02
<input type="checkbox"/> D3	--		192.168.254.4		--	IPCamera 03
<input type="checkbox"/> D4	--		192.168.254.5		--	IPCamera 04
<input type="checkbox"/> D5	--		192.168.254.6		--	IPCamera 05
<input type="checkbox"/> D6	--		192.168.254.7		--	IPCamera 06
<input type="checkbox"/> D7	--		192.168.254.8		--	IPCamera 07
<input type="checkbox"/> D8	--		192.168.254.9		--	IPCamera 08
...		--	10.16.1.251		--	--

Buttons: Refresh, Upgrade, Delete, Add All, Custom Add...

- Manual You can disable the PoE interface by selecting "Manual" while the current channel can be used as a normal channel and the parameters can also be edited.

Input the IP address, the user name and password of the administrator manually, and click "OK" to add the IP camera.



Edit IP Camera	
IP Camera No.	D1
Adding Method	Manual
IP Camera Address	192.168.254.2
Protocol	
Management Port	8000
Channel Port	1
User Name	admin
Admin Password	

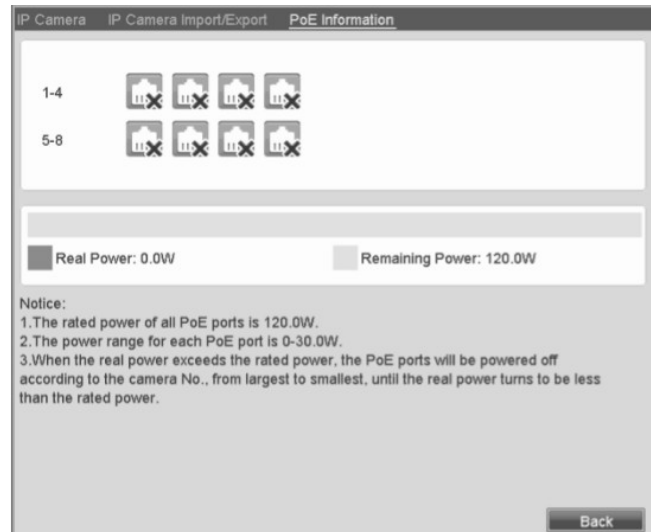
Buttons: OK, Cancel

5.8.4. Checking the PoE Information

This section is applicable to the models GRN-G1004P & GRN-G1116P only.

Steps:

1. Enter the Camera Management interface: Menu> Camera> Camera
2. Click on the “PoE Information” tab to view the PoE status.



3. You can see the PoE connection status: the connected PoE port is displayed as a picture with a “blue tick”, and the disconnected one is displayed as a picture with a “red cross”. Besides, the power consumption of each port and all ports are also clearly displayed.





6. Live View

6.1. Introduction of the Live View

The Live View shows you the video image received from each camera in real time. The NVR automatically enters Live View mode when powered on. It is also at the very top of the menu hierarchy, thus pressing the ESC many times (depending in which menu you are in) takes you to Live View mode.

Live View Icons:

In the live view mode, there are icons at the upper-right of the screen for each channel, showing the status of the recording and alarm in the channel, so that you can know whether the channel is recorded, or whether there are any alarms occurring as soon as possible.

Icons	Description
	Alarm (video loss, video tampering, motion detection, sensor alarm or VCA alarm)
	Recording (manual recording, continuous recording, motion detection, sensor alarm or VCA alarm triggered recording)
	Alarm & Recording
	Event/Exception (motion detection, sensor alarm, VCA alarm or exception information, appears at the lower-left corner of the screen. Please refer to Chapter “Setting Alarm Response Actions” for details.)

6.2. Operations in Live View Mode

In Live View mode, there are many functions provided. The functions are listed below.

- Single Screen: showing only one screen on the monitor.
- Multi-screen: showing multiple screens on the monitor simultaneously.
- Auto-switch: the screen is auto-switched to the next one. And you must set the dwell time for each screen in the configuration menu before enabling the auto-switch:













Menu> Configuration> Live View> Dwell Time.

- Start Recording: Continuous recording and motion detection recording are supported.
- Output Mode: Select the output mode from Standard, Bright, Gentle or Vivid.
- Add IP Camera: The shortcut to the IP camera management interface.
- Playback: Playback the recorded videos for the current day.

6.2.1. Using the Mouse in Live View

In Live View mode, when you right-click on the screen or move the mouse to the bottom of the screen, the main menu button and the live view toolbar will appear:



Icon	Name	Description
	Main Menu	Enter the main menu of the system.
	Single Screen	Switch to the single full screen live view mode.
	Multi-screen	Switch to multi-screen live view mode. The multi-screen icon varies according to the device models.
	Normal Record	Start all-day normal recording for all channels.
	Motion Detection Record	Start motion detection recording for all channels.
	All-day Playback	Play back the recording video.
	Output Mode	Set the video output mode to Standard, Bright, Gentle or Vivid.
	Add IP Camera	Enter the IP Camera Management interface to add the locally searched online IP camera quickly.
	Previous Screen	Switch to the previous screen.
	Next Screen	Switch to the next screen.
	Start/Stop Auto-switch	Enable/disable the auto-switch of the screens. The dwell time of the live view configuration must be set before using " Start Auto-switch ".
	Lock/Unlock	Lock/unlock the toolbar.

6.2.2. Quick Setting Toolbar in Live View Mode

On the screen of each channel, there is a quick setting toolbar which shows when you single click the mouse in the corresponding screen.



Icons	Description	Icons	Description	Icons	Description
	Enable Manual Record		Instant Playback		Mute/Audio on
	PTZ Control		Digital Zoom		Image Settings
	Live View Strategy		Close		

For details about the different buttons from the table, please refer to the explanations below:

Instant Playback :

Instant Playback only shows the recording from the last five minutes. If no recording is found, it means there was no recording during the last five minutes.

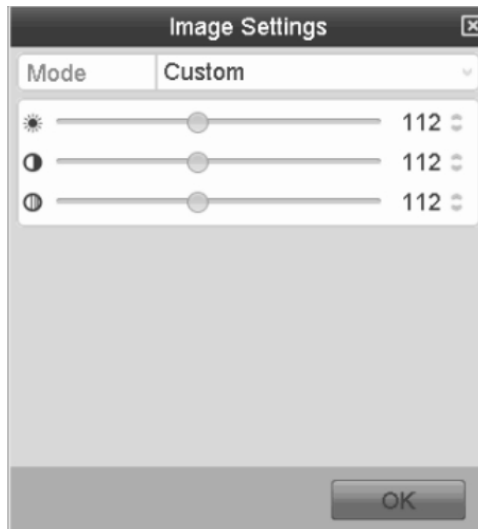
Digital Zoom :

Digital Zoom can zoom in the selected area to the full screen. You can left-click and draw to select the area for zooming in.

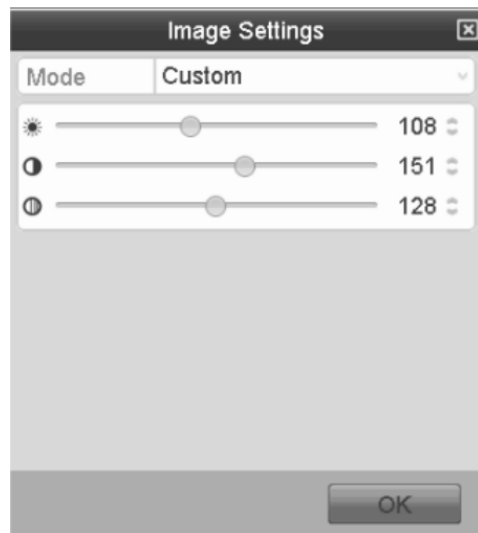


Image Settings :

The Image Settings icon can be selected to enter the Image Settings menu.

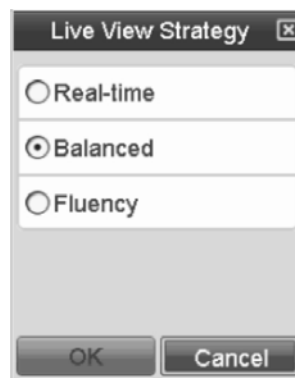


You can set here the image parameters like brightness, contrast, saturation and hue.



Live View Strategy :

Live View Strategy can be selected to set strategy, including Real-time, Balanced, Fluency.

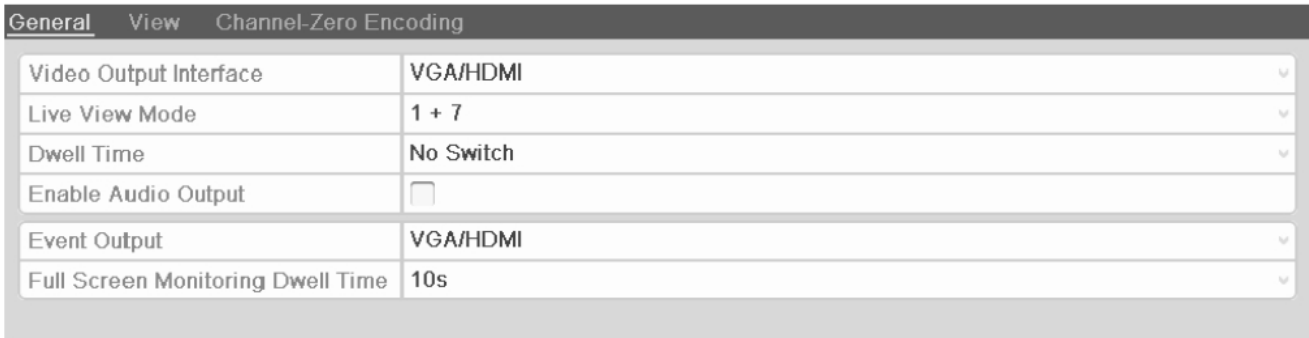


6.3. Adjusting the Live View Settings

The Live View settings can be customised according to different needs. You can configure the output interface, dwell time for the screen to be shown, mute or turning on the audio, the screen number for each channel, etc.

Steps:

1. Enter the Live View Settings interface: Menu> Configuration> Live View

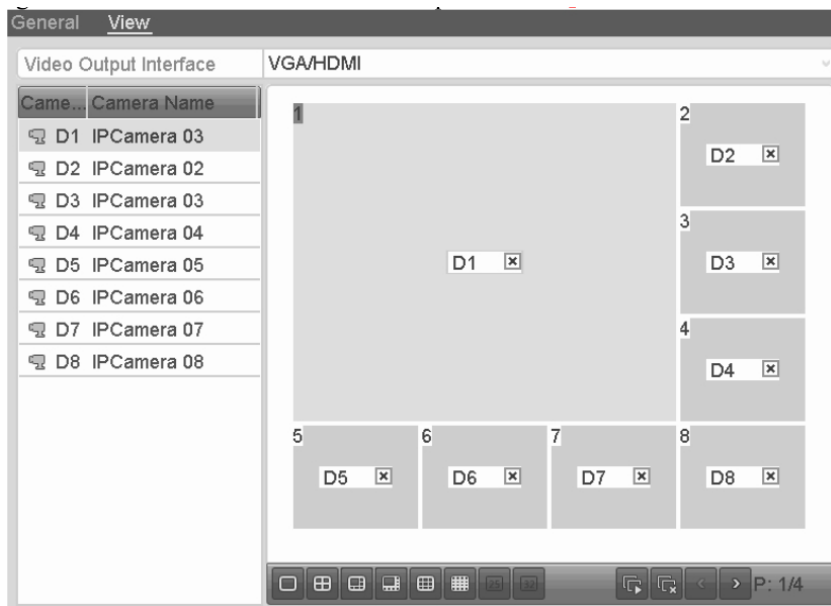


The settings available in this menu include:

- Video Output Interface: Designates the output to configure the settings for.
- Live View Mode: Designates the display mode to be used as default in this Video Output Interface.
- Dwell Time: The time in seconds to dwell between the switching of channels when "Auto-switch" in Live View is enabled.
- Enable Audio Output: Enables/disables audio output for the selected video output.
- Event Output: Designates the output to show the event video.
- Full Screen Monitoring Dwell Time: The time in seconds to show the alarm event screen.

2. View Tab:

Arrange the camera order for each Video Output Interface.



1) Select a View mode by pushing one of the View Buttons shown below:



2) Select a small window, and double-click on the channel number to display the channel in the window.

If you do not want the camera to be displayed in the live view interface, click the corresponding "X" button to stop it.

You can also click on the "[Forward image]" button to start the live view for all the channels and click the "[Delete Image]" button to stop all the live views.

3) Click the "Apply" button to save the setting.

6.4. Digital Spot

This chapter is only applicable to GRN-M1116N and GRN-M1232N.

Sometimes you need to get a remote view of many channels in real time from the web browser or CMS (Client Management System) software. In order to decrease the bandwidth requirements without affecting the image quality, the Digital Spot is supported as an option for you.

Steps:

1. Enter the Live View Settings interface: Menu > Configuration > Live View
2. Select the Digital Spot tab.
3. Check the checkbox after "Enable Digital Spot".
4. Configure the Frame Rate, Max. Bitrate Mode and Max. Bitrate.
5. Click the "Apply" button to activate the settings.

After you set the Digital Spot, you can get a view in the remote client or web browser of 16 channels in one screen.

7. PTZ Controls

7.1. Configuring the PTZ Settings

The purpose of this function is to follow the procedure to set the parameters for PTZ. The configuring of the PTZ parameters should be done before you control the PTZ camera.

Please note: Only cameras using Grundig-1 protocol make use of all the PTZ functions. Cameras using Grundig-2, ONVIF or any other protocol might need to be configured directly in the camera OSD.

Steps:

1. Enter the PTZ Settings interface: Menu > Camera > PTZ



2. Click the RS-485 Settings button to set the RS-485 parameters.



3. Choose the camera for PTZ setting in the "Camera" dropdown list.

4. Enter the parameters of the PTZ camera.

NOTE: All the parameters should be exactly the same as the PTZ camera parameters.

5. Click the "Apply" button to save the settings.

7.2. Setting the PTZ Presets, Patrols & Patterns

Before you start:

Please make sure that the presets, patrols and patterns should be supported by PTZ protocols.

7.2.1. Customising the Presets

Follow the steps to set the Preset location which you want the PTZ camera to point to when an event takes place.

Steps:

1. Enter the PTZ Control interface: Menu> Camera> PTZ



2. Use the directional button to wheel the camera to the location where you want to set the limit, and click the “Left Limit” or “Right Limit” button to link the location to the corresponding limit.

NOTE: A speed dome starts a linear scan from the left limit to the right limit, and you must set the left limit on the left side of the right limit, as well the angle from the left limit to the right limit should be no more than 180°.

2. Use the directional button to wheel the camera to the location where you want to set the limit, and click the “Left Limit” or “Right Limit” button to link the location to the corresponding limit.

NOTE: A speed dome starts a linear scan from the left limit to the right limit, and you must set the left limit on the left side of the right limit, as well the angle from the left limit to the right limit should be no more than 180°.

7.2.2. Calling the Presets

This feature enables the camera to point to a specified position such as a window when an event takes place.

Steps:

1. Click the button “PTZ” in the lower-right corner of the PTZ setting interface;
Or press the “PTZ” button on the front panel or click the “(PTZ Control)” icon in the quick setting bar, or select the “PTZ” option in the right-click menu to show the PTZ control panel.
2. Choose a Camera in the dropdown list.
3. Click the “>” button to show the general settings of the PTZ control.



4. Click to enter the preset No. in the corresponding text field.
5. Click the “Call Preset” button to call it.

7.2.3. Customising the Patrols

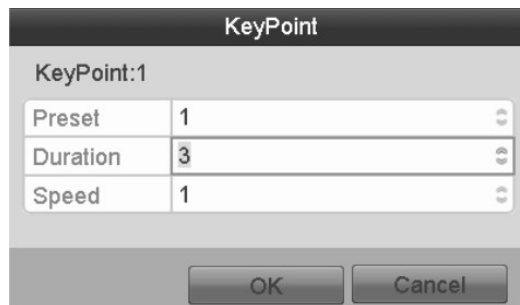
Patrols can be set to move the PTZ to different key points and have it stay there for a set duration before moving on to the next key point. The key points are corresponding to the presets. The presets can be set following the steps above in the chapter “Customising the Presets”.

Steps:

1. Enter the PTZ Control interface: Menu> Camera> PTZ



2. Select the Patrol No. in the drop-down list of "Patrol".
3. Click the "Set" button to add key points for the patrol.



4. Configure the key point parameters, such as the Key Point No., duration of staying for one key point and speed of patrol. The key point is corresponding to the preset. The "Key Point" No. Determines the order which the PTZ will follow while cycling through the patrol. The "Duration" refers to the time span for staying at the corresponding key point. "Speed" defines the speed at which the PTZ will move from one key point to the next.
5. Click the "Add" button to add the next key point to the patrol, and you can click the "OK" button to save the key point to the patrol.

You can delete all the key points by clicking the "Clear" button for the selected patrol, or click the "Clear All" button to delete all the key points for all patrols.

7.2.4. Calling the Patrols

Calling a patrol makes the PTZ move according the predefined patrol path.

Steps:

1. Click the button "PTZ" in the lower-right corner of the PTZ setting interface;
Or press the PTZ button on the front panel or click the "PTZ Control" icon in the quick setting bar, or select the PTZ option in the right-click menu to show the PTZ control panel.
2. Click the ">" button to show the general settings of the PTZ control.



3. Select a patrol in the dropdown list and click the "Call Patrol" button to call it.
4. You can click the "Stop Patrol" button to stop calling it.

7.2.5. Customising the Patterns

Patterns can be set by recording the movement of the PTZ. You can call the pattern to make the PTZ movement according to the predefined path.

Steps:

1. Enter the PTZ Control interface: Menu> Camera> PTZ



2. Choose the pattern number in the dropdown list.
3. Click the "Start" button and click the corresponding buttons in the control panel to move the PTZ camera, and click the "Stop" button to stop it.

The movement of the PTZ is recorded as the pattern.

7.2.6. Calling the Patterns

Follow the procedure to move the PTZ camera according to the predefined patterns.

Steps:

1. Click the button "PTZ" in the lower-right corner of the PTZ setting interface;
Or press the PTZ button on the front panel or click the "PTZ Control" icon in the quick setting bar, or select the PTZ option in the right-click menu to show the PTZ control panel.
2. Click the ">" button to show the general settings of the PTZ control.



3. Click the "Call Pattern" button to call it.
4. Click the "Stop Pattern" button to stop calling it.

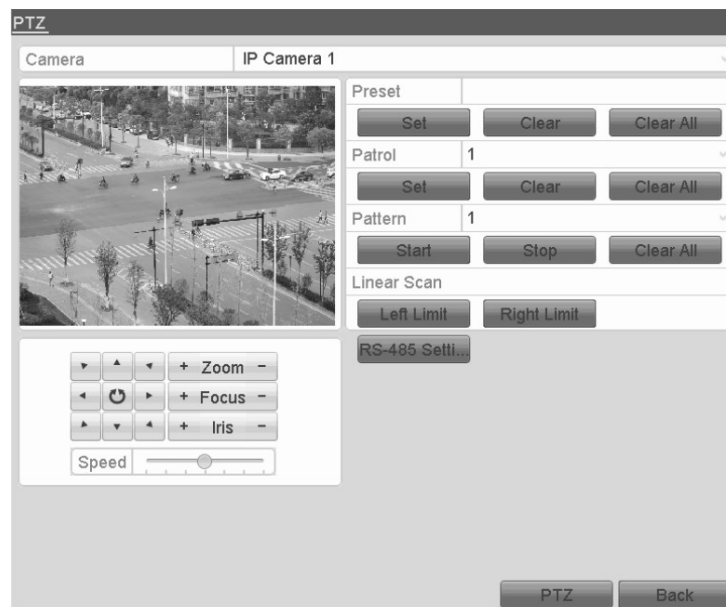
7.2.7. Customising the Linear Scan Limit

The Linear Scan can be enabled to trigger the scan in the horizontal direction in the predefined range.

NOTE: This function is supported by some models.

Steps:

1. Enter the PTZ Control interface: Menu> Camera> PTZ



2. Use the directional button to wheel the camera to the location where you want to set the limit, and click the "Left Limit" or "Right Limit" button to link the location to the corresponding limit.

NOTE: A speed dome starts a linear scan from the left limit to the right limit, and you must set the left limit on the left side of the right limit, as well the angle from the left limit to the right limit should be no more than 180°.

2. Use the directional button to wheel the camera to the location where you want to set the limit, and click the "Left Limit" or "Right Limit" button to link the location to the corresponding limit.

NOTE: A speed dome starts a linear scan from the left limit to the right limit, and you must set the left limit on the left side of the right limit, as well the angle from the left limit to the right limit should be no more than 180°.

7.2.8. Calling the Linear Scan

Follow the procedure to call the linear scan in the predefined scan range.

Steps:

1. Click the button "PTZ" in the lower-right corner of the PTZ setting interface;
Or press the "PTZ" button on the front panel or click the "PTZ Control" icon in the quick setting bar to enter the PTZ setting menu in live view mode.
2. Click the ">" button to show the one-touch function of the PTZ control.



3. Click "Linear Scan" button to start the linear scan and click the "Linear Scan" button again to stop it. You can click the "Restore" button to clear the defined left limit and right limit data and the dome needs to reboot to make settings take effect.

7.2.9. One-touch Park

For some models of the speed dome, you can configure to start a predefined park action (scan, preset, patrol and etc.) automatically after a period of inactivity (park time).

Steps:

1. Click the button "PTZ" in the lower-right corner of the PTZ setting interface;
Or press the PTZ button on the front panel or click the "PTZ Control" icon in the quick setting bar to enter the PTZ setting menu in live view mode.
2. Click the ">" button to show the one-touch function of the PTZ control.



3. There are 3 one-touch park types selectable, click the corresponding button to activate the park action.

- Park (Quick Patrol): The dome starts to patrol from the predefined preset 1 to preset 32 in this order after the park time. An undefined preset will be skipped.
- Park (Patrol 1): The dome starts to move according to the predefined patrol 1 path after the park time.
- Park (Preset 1): The dome moves to the predefined preset 1 location after the park time.

NOTE: The park time can only be set through the speed dome configuration interface, by default the value is 5s.

4. Click the button again to inactivate it.

7.3. PTZ Control Panel

To enter the PTZ control panel, two ways are supported.

OPTION 1:

In the PTZ settings interface, click the "PTZ" button on the lower-right corner which is next to the Back button.

OPTION 2:

In the Live View mode, you can press the "PTZ Control" button on the remote control, or choose the "PTZ Control" icon, or select the "PTZ" option in the right-click menu.

Click the "Configuration" button on the control panel, and you can enter the "PTZ" Settings interface.

NOTE: In PTZ control mode, the PTZ panel will be displayed when a mouse is connected with the device. If no mouse is connected, the "PTZ" icon appears in the lower-left corner of the window, indicating that this camera is in PTZ control mode.



Icon	Description	Icon	Description	Icon	Description
	Direction buttons and the auto-cycle button		Zoom+, Focus+, Iris+		Zoom-, Focus-, Iris-
	The speed of the PTZ movement		Light on/off		Wiper on/off
	3D-Zoom		Image Centralisation		Menu
	Switch to the PTZ control interface		Switch to the one-touch control interface		Switch to the general settings interface
	Previous item		Next item		Exit
	Minimise windows				

8. Recording Settings

8.1. Configuring Parameters

By configuring the parameters you can define the parameters which affect the image quality, such as the transmission stream type, the resolution and so on.

Before you start:

1. Make sure that the HDD has already been installed. If not, please install a HDD and initialise it. (Menu> HDD> General)

HDD Information								
<input type="checkbox"/>	Label	Capacity	Status	Property	Type	Free Space	Group	Edit Delete
<input type="checkbox"/>	2	465.76GB	Normal	R/W	Local	465GB	1	

2. Check the storage mode of the HDD.

- 1) Click "Advanced" to check the storage mode of the HDD.
- 2) If the HDD mode is "Quota", please set the maximum recording capacity. For detailed information, see the Chapter "Configuring the Quota Mode".
- 3) If the HDD mode is "Group", you should set the HDD group. For detailed information, see the Chapter "Configuring the HDD Group for Recording".

Mode	Group
Record on HDD Group	Quota
	Group
<input type="checkbox"/> IP Camera	<input checked="" type="checkbox"/> D1
	<input type="checkbox"/> D2
	<input type="checkbox"/> D3
	<input type="checkbox"/> D4

Steps:

1. Enter the Recording settings interface to configure the recording parameters: Menu> Record> Parameters

Record		Substream	
Camera	IP Camera 1		
Encoding Parameters	Main Stream(Continuous)	Main Stream(Event)	
Stream Type	Video & Audio	Video & Audio	Video & Audio
Resolution	1280*960(XVGA)	1280*960(XVGA)	1280*960(XVGA)
Bitrate Type	Variable	Variable	Variable
Video Quality	Medium	Medium	Medium
Frame Rate	Full Frame	Full Frame	Full Frame
Max. Bitrate Mode	General	General	General
Max. Bitrate(Kbps)	2048	2048	2048
Max. Bitrate Range Reco...	3072~5120(Kbps)	3072~5120(Kbps)	3072~5120(Kbps)
Pre-record	5s		
Post-record	5s		
Expired Time (day)	0		
Record Audio	<input checked="" type="checkbox"/>		
Video Stream	Main Stream		

2. Parameters Setting for Recording:

1) Select the Recording tab page to configure the settings. You can configure the stream type, the resolution, and other parameters on your demand.

- Pre-record: The time you set to record before the scheduled time or event. For example, when an alarm triggered the recording at 10:00, if you set the pre-recording time as 5 seconds, the camera records it at 9:59:55.
- Post-record: The time you set to record after the event or the scheduled time. For example, when an alarm triggered the recording ends at 11:00, if you set the post-recording time as 5 seconds, it records till 11:00:05.
- Expired Time: The expired time is the longest time for a recording file to be kept in the HDD, if the deadline is reached, the file will be deleted. You can set the expired time to 0, and then the file will not be deleted. The actual keeping time for the file should be determined by the capacity of the HDD.
- Redundant Record: Enabling redundant recording means that the recording files will be saved on the redundant HDD. See the Chapter "Configuring the Redundant Recording".
- Record Audio: Check the checkbox to enable or disable audio recording.
- Video Stream: Main stream and sub-stream are selectable for recording. When you select "Sub-stream", you can record for a longer time with the same storage space.

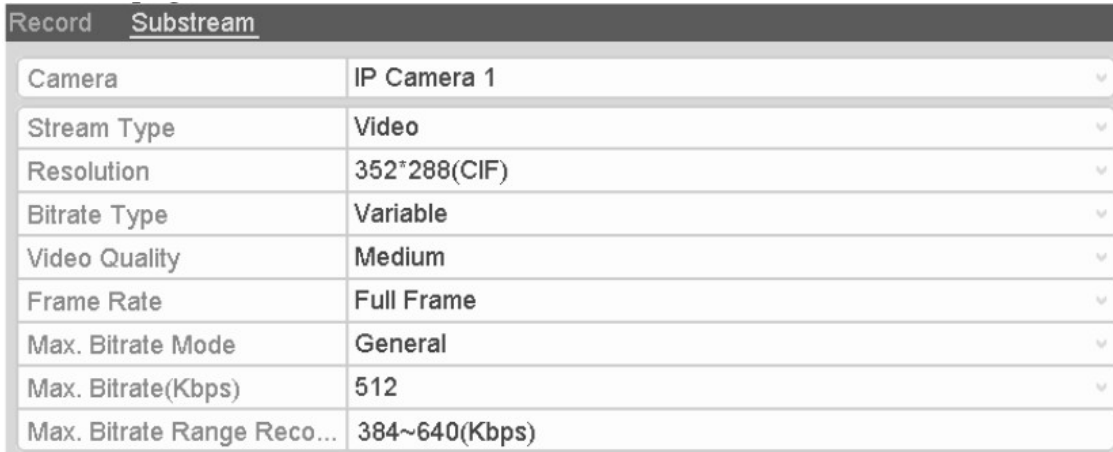
2) Click "Apply" to save the settings.

NOTE:

- The redundant recording is for deciding whether you want the camera to save the recording files on the redundant HDD. You must configure the redundant HDD in the HDD settings.
- The parameters of “Main Stream (Event)” are read-only.

3. Parameters Settings for “Sub-stream”:

1) Enter the “Sub-stream” tab page.



Record	Substream
Camera	IP Camera 1
Stream Type	Video
Resolution	352*288(CIF)
Bitrate Type	Variable
Video Quality	Medium
Frame Rate	Full Frame
Max. Bitrate Mode	General
Max. Bitrate(Kbps)	512
Max. Bitrate Range Reco...	384~640(Kbps)

- 2) Configure the parameters of the camera.
- 3) Click “Apply” to save the settings.

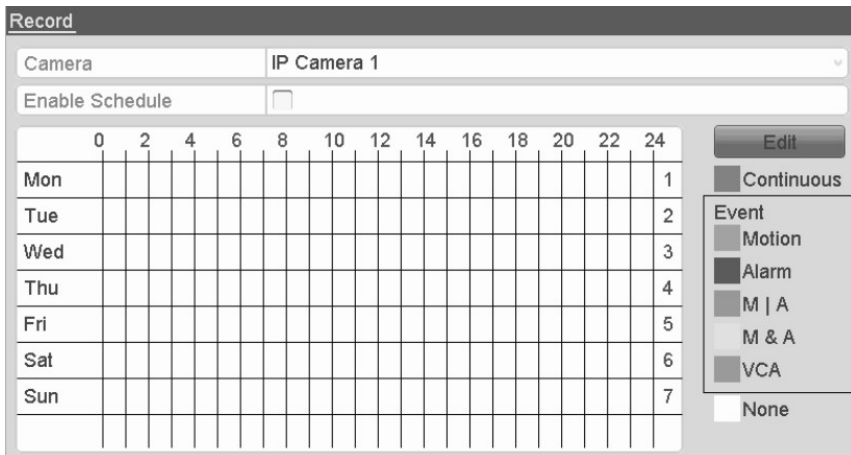
8.2. Configuring the Recording Schedule

Set the recording schedule, and then the camera automatically starts/stops recording according to the configured schedule.

Steps:

- 1. Enter the Recording Schedule interface: Menu> Record> Schedule
- 2. Configure the Recording Schedule:

1) Select “Record Schedule”.



Record	Camera	IP Camera 1													
Enable Schedule	<input type="checkbox"/>														
	0	2	4	6	8	10	12	14	16	18	20	22	24		
Mon														1	
Tue														2	
Wed														3	
Thu														4	
Fri														5	
Sat														6	
Sun														7	

Event

- Continuous
- Motion
- Alarm
- M | A
- M & A
- VCA
- None

- 2) Choose the camera you want to configure.
- 3) Select the check box after the "Enable Schedule" item.
- 4) Click the "Edit" button or click on the colour icon under the "Edit" button and draw the schedule line on the panel.

Edit the schedule:

- I. In the message box, you can choose the day for which you want to set a schedule.

Schedule		Mon	
All Day	<input type="checkbox"/>	Type	Normal
Start/End Time	06:00-14:00	Type	Normal
Start/End Time	16:00-18:00	Type	Motion
Start/End Time	00:00-00:00	Type	Normal
Start/End Time	00:00-00:00	Type	Normal
Start/End Time	00:00-00:00	Type	Normal
Start/End Time	00:00-00:00	Type	Normal
Start/End Time	00:00-00:00	Type	Normal
Start/End Time	00:00-00:00	Type	Normal

Copy Apply OK Cancel

You can click the "[clock]" button to set the accurate time of the schedule.

- II. To schedule an all-day recording, check the checkbox after the "All Day" item.

Weekday		Mon	
All Day	<input checked="" type="checkbox"/>	Type	Continuous
Start/End Time	00:00-24:00	Type	VCA
Start/End Time	00 : 00 - 24 : 00	Type	Continuous
Start/End Time	00:00-00:00	Type	Continuous

- III. To arrange another schedule, leave the "All Day" checkbox blank and set the Start/End time.

NOTE: Up to 8 periods can be configured for each day. The time periods cannot overlap each other.

- IV. Select the recording type in the dropdown list.

NOTE:

- To enable Motion, Alarm, M | A (motion or alarm), M & A (motion and alarm) and VCA (Video Content Analysis) triggered recording and capture, you must configure the motion detection settings, alarm input settings or VCA settings as well. For detailed information, refer to Chapter 8.1, Chapter 8.2 and Chapter 8.5.

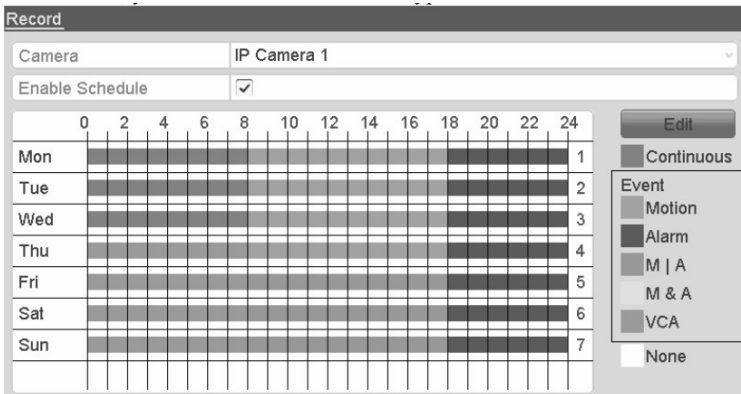
- The VCA settings are only available to IP cameras that are supporting these functions.

Repeat the above edit schedule steps to schedule the recording for other days in the week. You can click "Copy" to enter "Copy to interface" to copy the schedule settings to other days.

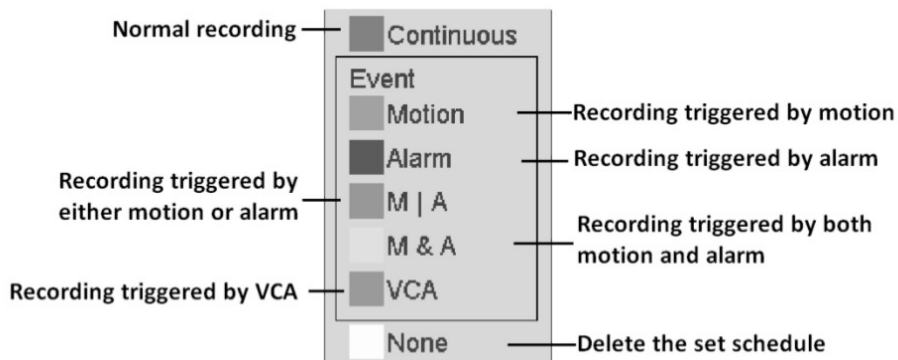
V. Click "Apply" in the Recording Schedule interface to save the settings.

Draw the schedule:

I. If you click on the colour icons, you can choose the schedule type as "Continuous" or "Event".

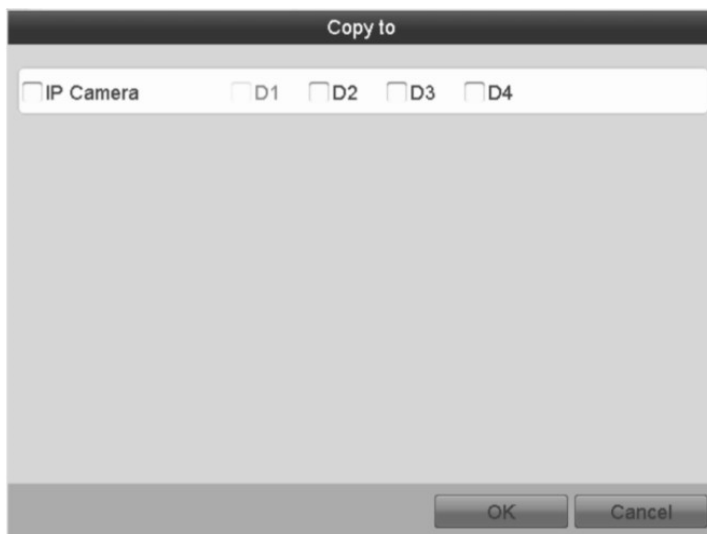


Descriptions of the colour icons are shown in the figure below.



II. Click the “Apply” button to validate the settings.

3. (Optional) If the settings can also be used for other channels, click “Copy”, and then choose the channel to which you want to copy.



4. Click “Apply” to save the settings.

8.3. Configuring the Motion Detection Recording

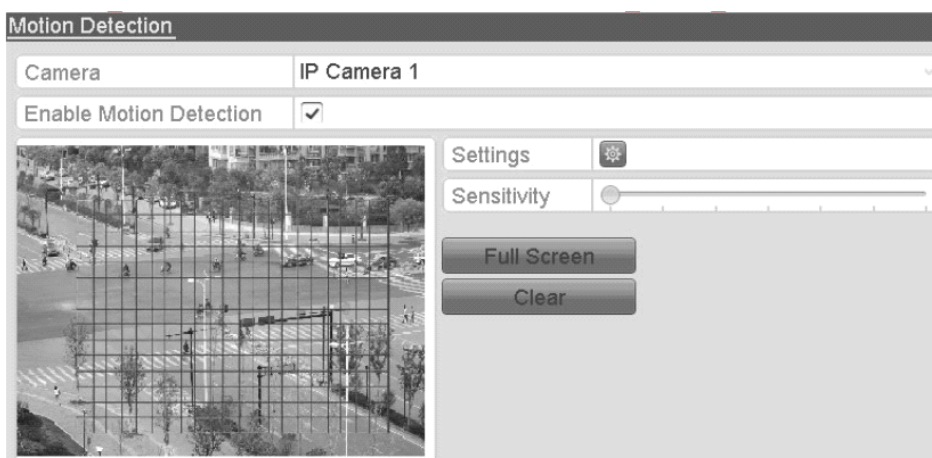
Follow the steps to set the motion detection parameters. In live view mode, once a motion detection event takes place, the NVR can analyse it and perform many actions to handle it. Enabling the motion detection function can trigger certain channels to start recording, or trigger full screen monitoring, audio warning, notifying the surveillance center and so on. In this chapter, you can follow the steps to schedule a recording which is triggered by the detected motion.

Please note: Only cameras using Grundig-1 protocol can be configured for motion recording with the NVR. Cameras using Grundig-2, ONVIF or any other protocol need to be configured directly in the camera OSD.

Steps:

1. Enter the Motion Detection interface: Menu> Camera> Motion
2. Configure the Motion Detection:

- 1) Choose the camera you want to configure.
- 2) Check the checkbox after “Enable Motion Detection”.
- 3) Drag and draw the area for motion detection by mouse. If you want to set the motion detection for all the area shot by the camera, click “Full Screen”. To clear the motion detection area, click “Clear”.



4) Click "Settings", and the message box for channel information will pop up.



5) Select the channels for which you want a motion detection event to trigger a recording.

6) Click "Apply" to save the settings.

7) Click "OK" to go back to the upper level menu.

8) Exit the Motion Detection menu.

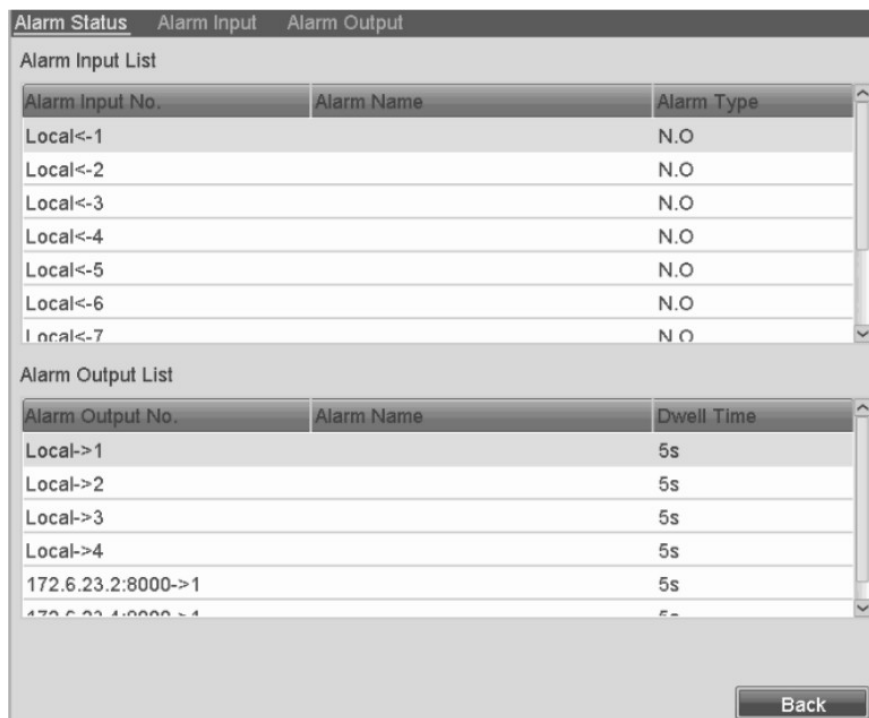
3. Edit the Motion Detection Recording Schedule. For detailed information of schedule configuration, see Chapter "Configuring the Recording Schedule".

8.4. Configuring the Alarm Triggered Recording

Follow the procedure to configure the alarm triggered recording.

Steps:

1. Enter the Alarm setting interface: Menu> Configuration> Alarm



2. Click the "Alarm Input" tab and set the alarm parameters.

Alarm Status	Alarm Input	Alarm Output
Alarm Input No.	Local<-1	
Alarm Name		
Type	N.O	
Enable	<input type="checkbox"/>	
Settings		

- 1) Select the Alarm Input number and configure the alarm parameters.
- 2) Choose N.O (normally open) or N.C (normally closed) as the alarm type.
- 3) Check the checkbox at "Enable".
- 4) Click on the "[cogwheel]" button next to "Settings".

Trigger Channel	Arming Schedule	Linkage Action	PTZ Linking
<input type="checkbox"/> IP Camera	<input type="checkbox"/> D1	<input type="checkbox"/> D2	<input type="checkbox"/> D3
	<input type="checkbox"/> D4	<input type="checkbox"/> D5	<input type="checkbox"/> D6
	<input type="checkbox"/> D7	<input type="checkbox"/> D8	<input type="checkbox"/> D9

Apply OK Cancel

- 5) Choose the alarm triggered recording channel.
- 6) Check the checkboxes to select the channels.
- 7) Click "Apply" to save the settings.
- 8) Click "OK" to go back to the upper level menu.

Repeat the above steps to configure other alarm input parameters.

If the settings can also be applied to other alarm inputs, click "Copy" and choose the alarm input number.

Alarm Input No.	Alarm Name
<input type="checkbox"/> Local<-1	
<input type="checkbox"/> Local<-2	
<input type="checkbox"/> Local<-3	
<input type="checkbox"/> Local<-4	
<input type="checkbox"/> Local<-5	
<input type="checkbox"/> Local<-6	
<input type="checkbox"/> Local<-7	
<input type="checkbox"/> Local<-8	
<input type="checkbox"/> 172.6.23.2:8000<-1	
<input type="checkbox"/> 172.6.23.4:8000<-1	

OK Cancel

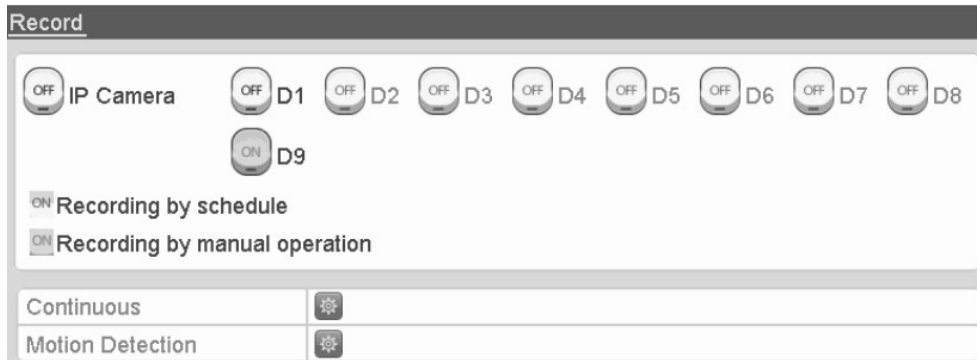
3. Edit the Alarm triggered recording in the Recording Schedule setting interface. For detailed information about the schedule configuration, see Chapter "Configuring the Recording Schedule".

8.5. Configuring the Manual Recording

Follow the steps below to set the parameters for the manual recording. When using Manual Recording, you need to manually cancel the recording. The manual recording is prior to the scheduled recording.

Steps:

1. Enter the Manual settings interface: Menu> Manual



2. Enable the Manual Recording:

1) Select "Record" on the left bar.

2) Click the status button in front of the camera number to change from "OFF" to "ON".

3. Disable Manual Recording:

Click the status button to change from "ON" to "OFF".

NOTE: The "ON" written in green means that the channel is configured for the recording schedule. After rebooting, all the manual recordings enabled will be canceled.

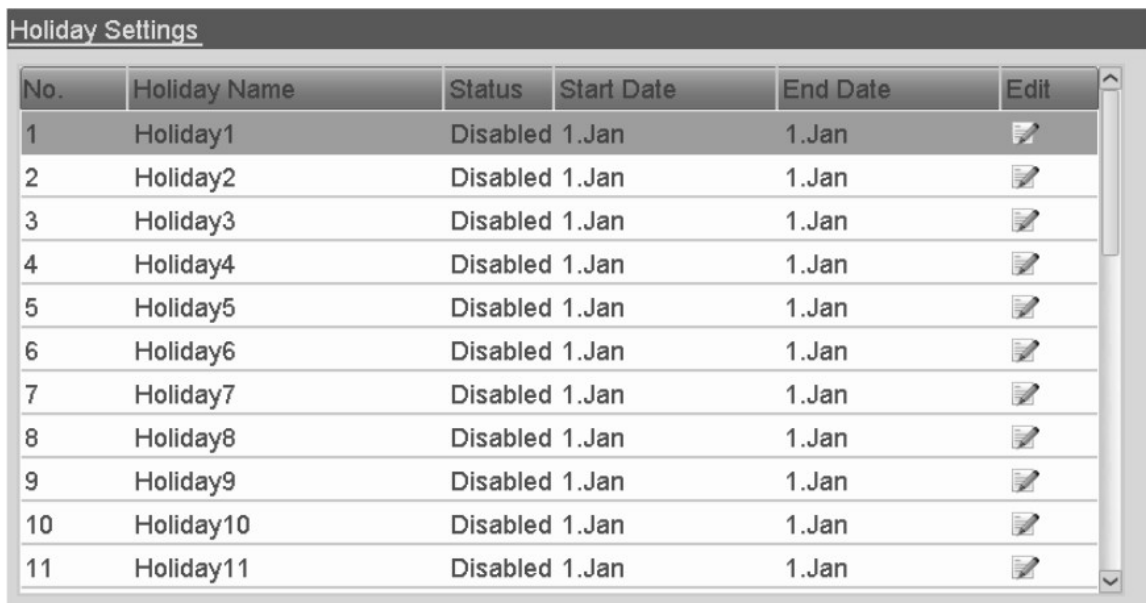
8.6. Configuring the Holiday Recording












Follow the steps to configure the recording schedule on holidays for that year as you may want to have a different plan for recording on a holiday.

Steps:

1. Enter the Recording setting interface:

Menu> Record> Holiday



No.	Holiday Name	Status	Start Date	End Date	Edit
1	Holiday1	Disabled	1.Jan	1.Jan	
2	Holiday2	Disabled	1.Jan	1.Jan	
3	Holiday3	Disabled	1.Jan	1.Jan	
4	Holiday4	Disabled	1.Jan	1.Jan	
5	Holiday5	Disabled	1.Jan	1.Jan	
6	Holiday6	Disabled	1.Jan	1.Jan	
7	Holiday7	Disabled	1.Jan	1.Jan	
8	Holiday8	Disabled	1.Jan	1.Jan	
9	Holiday9	Disabled	1.Jan	1.Jan	
10	Holiday10	Disabled	1.Jan	1.Jan	
11	Holiday11	Disabled	1.Jan	1.Jan	

2. Enabling the Edit Holiday schedule:

1) Click on the “[pen on a written sheet]” button to enter the “Edit” interface.

Edit	
Holiday Name	Holiday1
Enable	<input checked="" type="checkbox"/>
Mode	By Date
Start Date	2013-08-15
End Date	2013-08-15

Apply OK Cancel

2) Check the checkbox after “Enable Holiday”.

3) Select “Mode” from the dropdown list.

There are three different modes for the date format to configure a holiday schedule.

4) Set the start and end date.

5) Click “Apply” to save the settings.

6) Click “OK” to exit the Edit interface.

3. Enter the Recording Schedule settings interface to edit the holiday recording schedule. For details, see Chapter 6.2 “Configuring the Recording Schedule”.

8.7. Configuring the Redundant Recording (only for GRN-M1116N & GRN-M1232M)

This function is only available for GRN-M1116N & GRN-M1232M.

The function is for redundant recording which means that saving the recording files, not only on the R/W HDD but also on the redundant HDD, will effectively enhance the data safety and reliability.

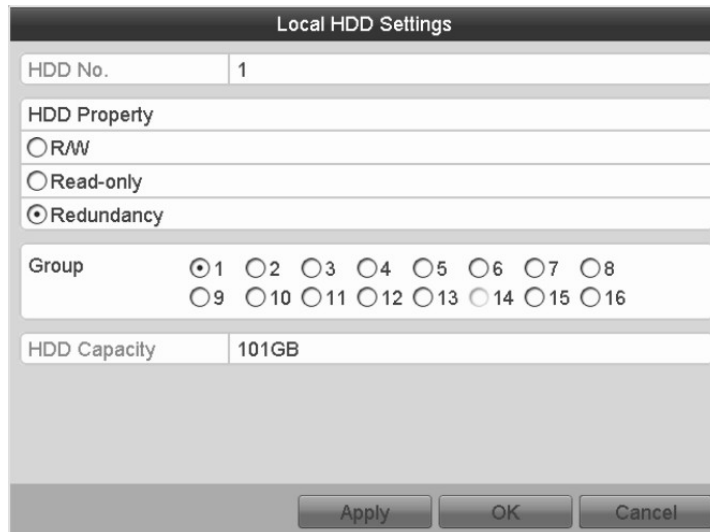
Steps:

1. Enter the HDD Information interface: Menu> HDD

Label	Capacity	Status	Property	Type	Free Space	Gro...	Edit	Del...
1	931.51GB	Normal	R/W	Local	931GB	1		

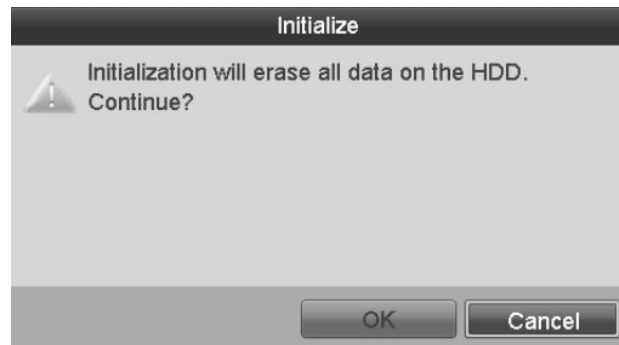
2. Select the “HDD” and click on the “[pen on a written sheet]” button to enter the Local HDD Settings interface.

1) Set the HDD property to “Redundancy”.



2. Select the “HDD” and click on the “[pen on a written sheet]” button to enter the Local HDD Settings interface.

1) Set the HDD property to “Redundancy”.



- 2) Click "Apply" to save the settings.
- 3) Click "OK" to go back to the upper level menu.

NOTE: You must set the Storage mode in the HDD advanced settings to "Group" before you set the HDD property to "Redundant". For detailed information, please refer to Setting the HDD Property. There should be at least another HDD which is in Read/Write status.

3. Enter the Recording setting interface: Menu> Record> Parameters

- 1) Select the "Record" tab.

Record		Substream	
Camera	IP Camera 1		
Encoding Parameters	Main Stream(Continuous)	Main Stream(Event)	
Stream Type	Video & Audio	Video & Audio	
Resolution	1280*960(XVGA)	1280*960(XVGA)	
Bitrate Type	Variable	Variable	
Video Quality	Medium	Medium	
Frame Rate	Full Frame	Full Frame	
Max. Bitrate Mode	General	General	
Max. Bitrate(Kbps)	2048	2048	
Max. Bitrate Range Reco...	3072~5120(Kbps)	3072~5120(Kbps)	
Pre-record	5s		
Post-record	5s		
Expired Time (day)	0		
Record Audio	<input checked="" type="checkbox"/>		
Video Stream	Main Stream		

- 2) Select the Camera you want to configure in the drop-down list.
- 3) Check the checkbox of "Redundant Record".
- 4) Click "OK" to save the settings and to go back to the upper level menu.

Repeat the above steps for configuring other channels.

8.8. Configuring the HDD Group for Recording

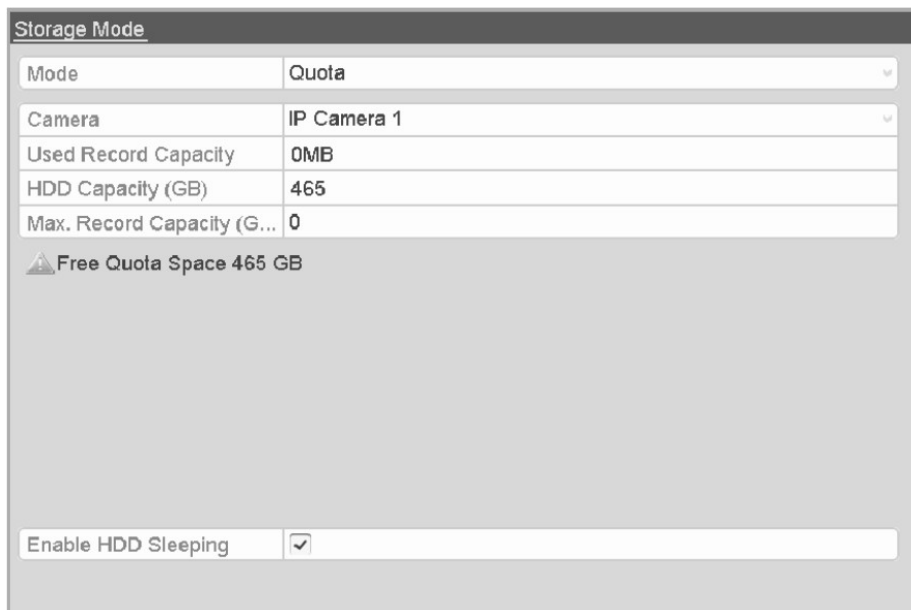
You can group the HDDs and save the recording files in a certain HDD group.

Steps:

1. Enter the HDD setting interface: Menu> HDD

HDD Information								
<input type="checkbox"/>	Label	Capacity	Status	Property	Type	Free Space	Group	Edit Delete
<input type="checkbox"/>	2	465.76GB	Normal	R/W	Local	465GB	1	...

2. Select "Advanced" on the left side menu.



Check whether the storage mode of the HDD is "Group". If not, set it to "Group". For detailed information, please refer to Chapter "Managing a HDD Group".

3. Select "General" in the left side menu.

4. Click on the "[pencil on a written sheet]" button to enter the editing interface.

5. Configuring the HDD group:

1) Choose a group number for the HDD group.

2) Click "Apply" and then in the pop-up message box, click "Yes" to save your settings.

3) Click "OK" to go back to the upper level menu.

Repeat the above steps to configure more HDD groups.

6. Choose the Channels for which you want to save the recording files in the HDD group.

1) Select "Advanced" on the left bar.

2) Choose a Group number in the dropdown list of "Record on HDD Group".

3) Check the channels you want to save in this group.

4) Click "Apply" to save the settings.

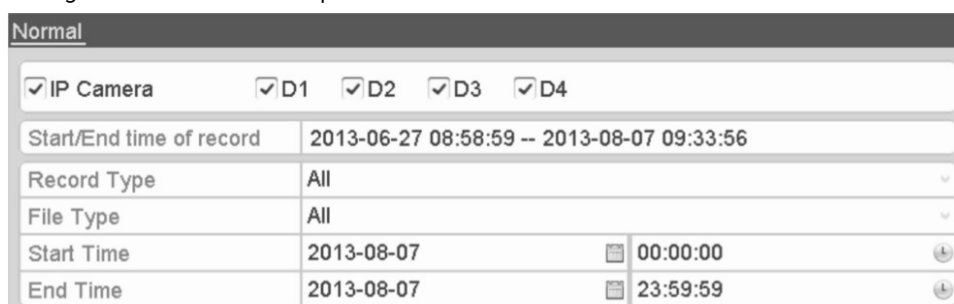
8.9. Files Protection

You can lock the recorded files or set the HDD property to Read-only to protect the recording files from being overwritten.

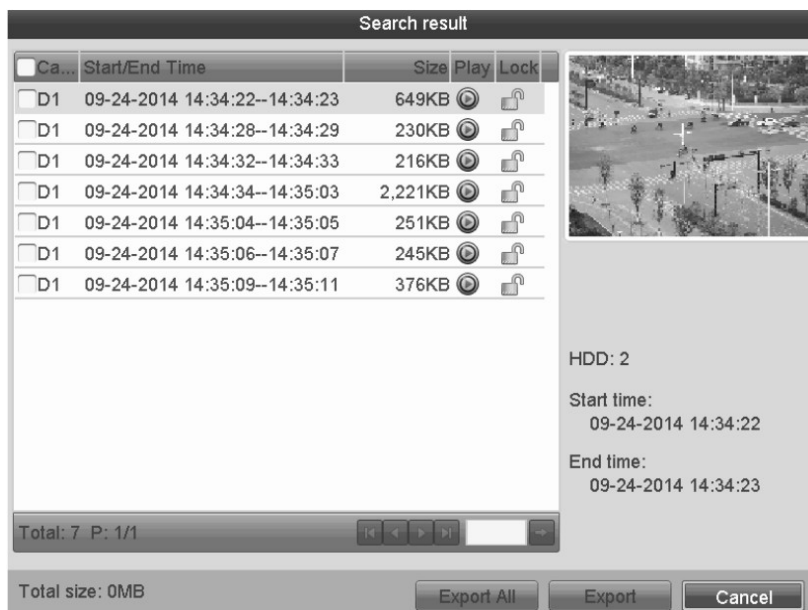
Protect a file by locking the recording files:

Steps:

1. Enter Export setting interface: Menu> Export



2. Select the channels you want to investigate by checking the checkbox.
3. Configure the recording type, file type and start/end time.
4. Click "Search" to show the results.

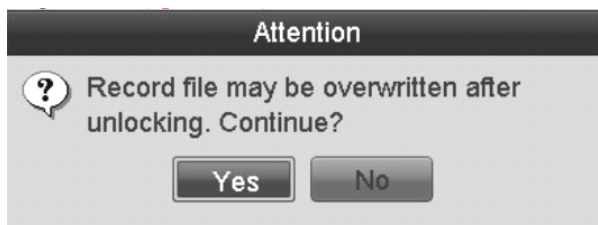


5. Protect the recording files.

1) Find the recording files you want to protect, and then click on the "{open lock}" icon which will turn to a "{closed lock}", indicating that the file is locked.

NOTE: The recording files for which the recording is not completed yet cannot be locked.

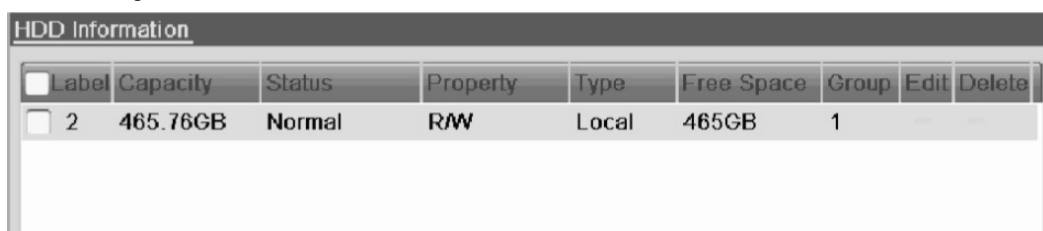
2) Click on "{closed lock}" to change it to "{open lock}" to unlock the file and the file will not be protected anymore.



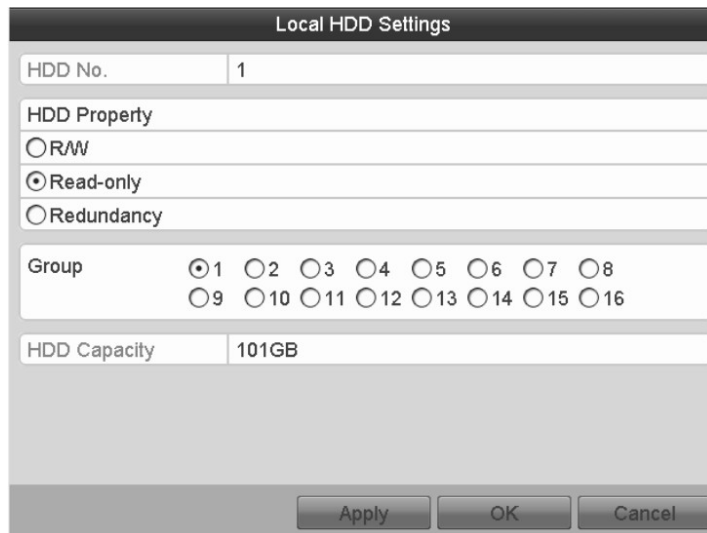
Protect a file by setting the HDD property to "Read-only":

Steps:

1. Enter the HDD setting interface: Menu> HDD



2. Click on the “[pencil on a written sheet]” button to edit the HDD you want to protect.



The image shows a dialog box titled "Local HDD Settings". It contains the following fields and options:

- HDD No.:** A text field containing the number "1".
- HDD Property:** A section with three radio button options: R/W, Read-only, and Redundancy.
- Group:** A section with 16 radio button options, numbered 1 through 16. Option 1 is selected.
- HDD Capacity:** A text field containing "101GB".
- Buttons:** At the bottom right, there are three buttons: "Apply", "OK", and "Cancel".

NOTE: To edit the HDD property, you need to set the storage mode of the HDD to “Group”. See Chapter “Managing a HDD Group”.

3. Set the HDD property to “Read-only”.

4. Click “OK” to save the settings and to go back to the upper level menu.

NOTE:

- You cannot save any files on a Read-only HDD. If you want to save files on the HDD, change the property to “R/W”.
- If there is only one HDD and it is set to “Read-only”, the NVR cannot record any files. Only live view mode is then available.
- If you set the HDD to “Read-only” when the NVR is saving files on it, then the file will be saved on the next R/W HDD. If there is only one HDD, the recording will be stopped.

9. Playback

9.1. Playing Back Recording Files

9.1.1. Playing Back by Channel

This explains how to play back the recorded video files of a specific channel in the live view mode. The Channel switch is supported.

Instant playback by channel:

Steps:

Choose a channel in live view mode using the mouse and click the “(backward arrow on an SD card)” button in the quick setting toolbar.

NOTE: In the instant playback mode, only the recording files recorded during the last five minutes on this channel will be played back.



All-day Playback by channel:

1. Enter the All-day Playback interface.

OPTION 1:

Right-click on the live view window and the live view toolbar appears at the bottom of the screen. Then click the icon “(backward arrow on a photo negative)” on the live view toolbar to enter the Playback interface.



NOTE: Pressing numerical buttons will switch the playback to the corresponding channels during the playback process.

2. Playback management:

The toolbar in the bottom part of the Playback interface can be used to control the playing progress.



Click on the channel(s) to execute simultaneous playback of multiple channels.

NOTE: The writing "09-24-2014 14:34:22 – 09-24-2014 14:41:10" indicates the start/end time of the recording.



NOTE: For the Playback progress bar: use the mouse to click any point of the progress bar or drag the progress bar to locate special frames.

Button	Operation	Button	Operation	Button	Operation
	Mute/Audio on		Start/Stop clipping		Save clip(s)
	Add default tag		Add customised tag		Tag management
	Digital Zoom		Pause/ Play Reverse		Pause/Play
	Stop		30s reverse		30s forward
	Slow forward		Fast forward		Previous day
	Next day		Scaling up/down time bar		Process bar
	Normal playback		Full Screen		Exit

9.1.2. Playing Back by Time

This function plays back video files recorded in a specified time duration. Multi-channel simultaneous playback and channel switch are supported.

Steps:

1. Enter the playback interface: Menu> Playback
2. Check the checkbox of the channel(s) in the channel list and then double-click to select a date on the calendar.



This function plays back video files recorded in a specified time duration. Multi-channel simultaneous playback and channel switch are supported.

Steps:

1. Enter the playback interface: Menu> Playback
2. Check the checkbox of the channel(s) in the channel list and then double-click to select a date on the calendar.

NOTE: If there are recording files for that camera in that day, in the calendar, the icon for that day is displayed as a number in a dark coloured square. Otherwise it is displayed as a number in a light coloured square.

In the Playback interface:

The toolbar in the bottom part of Playback interface can be used to control the playing process.



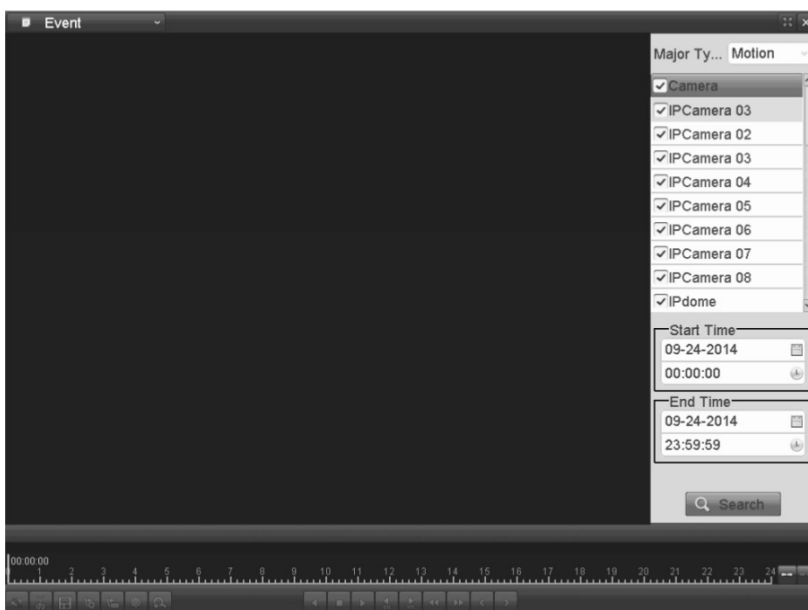
9.1.3. Playing Back by Event Search

This function plays back the recording files on one or several channels searched out by the restricting event type (e.g. alarm input and motion detection).

Steps:

1. Enter the Playback interface: Menu> Playback
2. Select "Event" in the drop-down list on the top-left side.
3. Select "Alarm Input", "Motion" or "VCA" as the event type, edit the Start time and End time.

NOTE: Here we take playback by motion as the example.



4. Click the "Search" button to get the search result information. You may refer to the right-side bar for the result.

Sour...	Start Time	Play
D1	14:44:03	▶
D1	14:44:22	▶
D1	14:45:02	▶
D1	14:45:13	▶
D1	14:45:48	▶
D1	14:51:47	▶
D1	14:52:17	▶
D1	14:55:19	▶
D1	14:58:13	▶
D1	14:58:43	▶
D1	15:00:25	▶
D1	15:01:10	▶
D1	15:04:18	▶

5. Click the ">" button to play back the file.
You can click the "Back" button to go back to the search interface.

NOTE: Pre-play and post-play can be configured.

6. Playback interface:
The toolbar in the bottom part of Playback interface can be used to control the playing process.



This function plays back video files recorded in a specified time duration. Multi-channel simultaneous playback and channel switch are supported.

Steps:

1. Enter the playback interface: Menu> Playback
2. Check the checkbox of the channel(s) in the channel list and then double-click to select a date on the calendar.



This function plays back video files recorded in a specified time duration. Multi-channel simultaneous playback and channel switch are supported.

Steps:

1. Enter the playback interface: Menu> Playback
2. Check the checkbox of the channel(s) in the channel list and then double-click to select a date on the calendar.

9.1.4. Playing Back by Tag

The Video tag allows you to record related information like people and location at a certain time point during playback. You are also allowed to use video tag(s) to search for recording files and position a time point.

Before playing back by tag:

1. Enter the Playback interface: Menu> Playback
2. Search and play back the recording file(s). Refer to Chapter 6.1.1 for detailed information about searching and playback of the recording files.

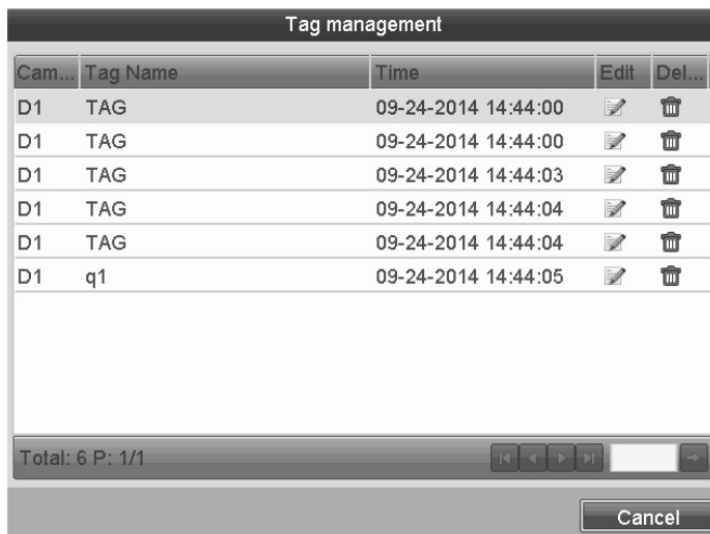


Click the “[flag with a plus]” button to add a default tag.
Click the “[flag with dots]” button to add a customised tag and input a tag name.

NOTE: Max. 64 tags can be added to a single video file.

3. Tag management:

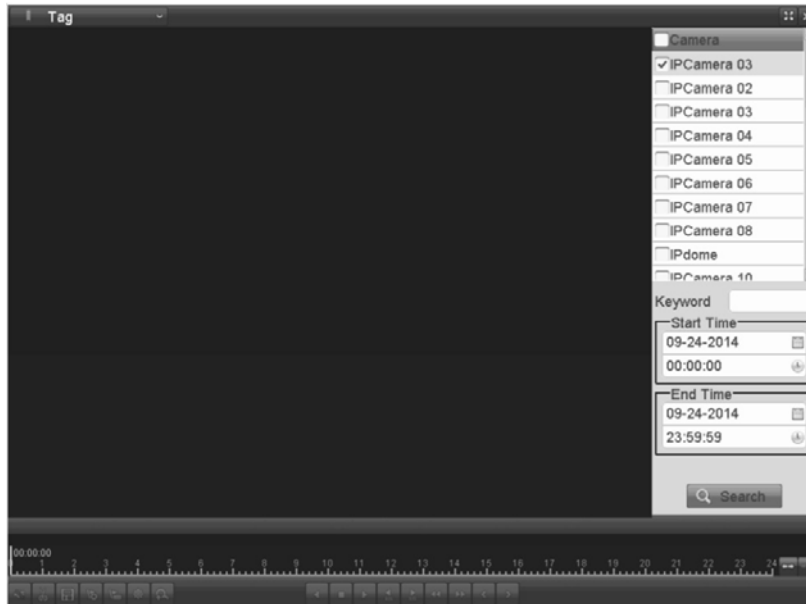
Click the “[cogwheel]” button to check, edit and delete tag(s).



Steps:

1. Select “Tag” from the drop-down list in the Playback interface.
2. Choose channels, edit the start time and end time, and then click “Search” to enter the Search Result interface.

NOTE: You can enter the keyword in the textbox next to “Keyword” to search the tag on your command.



- Click the ">" button to play back the file.
You can click the "Back" button to go back to the search interface.

NOTE: Pre-play and post-play can be configured.

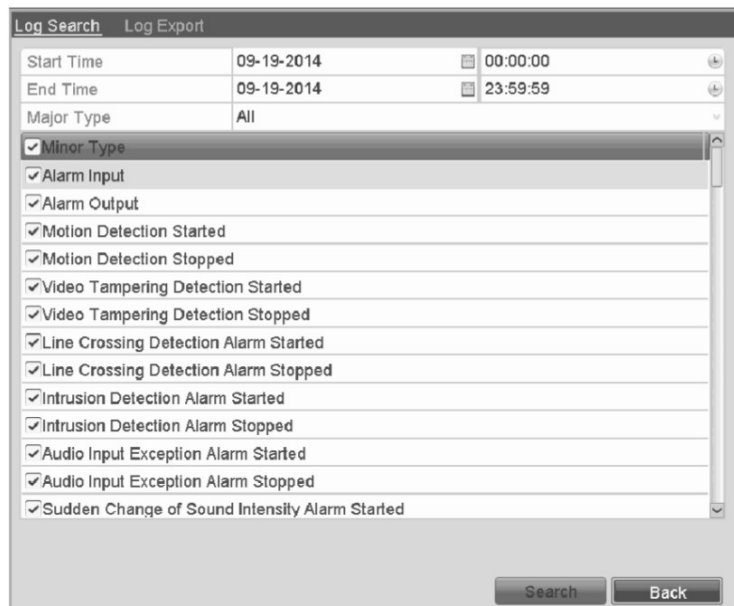


9.1.5. Playing Back by System Logs

This function plays back recording file(s) associated with channels after searching the system logs.

Steps:

- Enter the Log Information interface: Menu> Maintenance> Log Information
- Click the "Log Search" tab to enter the Playback by System Logs.
Set the search time and type and click the "Search" button.



3. Choose a log with the recording file and click the ">" button to enter the Playback interface.

NOTE: If there is no recording file at the time point of the log, the message box "No result found" will pop up.

No.	Major Type	Time	Minor Type	Parameter	Play	Details
1	Operation	09-19-2014 08:54:46	Power On	N/A	▶	✓
2	Information	09-19-2014 08:54:46	Local HDD Infor...	N/A	▶	✓
3	Operation	09-19-2014 08:54:49	Local Operation:...	N/A	▶	✓
4	Exception	09-19-2014 08:55:09	IP Camera Disco...	N/A	▶	✓
5	Exception	09-19-2014 08:55:09	IP Camera Disco...	N/A	▶	✓
6	Exception	09-19-2014 08:55:09	IP Camera Disco...	N/A	▶	✓
7	Exception	09-19-2014 08:55:09	IP Camera Disco...	N/A	▶	✓
8	Exception	09-19-2014 08:55:09	IP Camera Disco...	N/A	▶	✓
9	Exception	09-19-2014 08:55:09	IP Camera Disco...	N/A	▶	✓
10	Exception	09-19-2014 08:55:09	IP Camera Disco...	N/A	▶	✓
11	Exception	09-19-2014 08:55:09	IP Camera Disco...	N/A	▶	✓
12	Exception	09-19-2014 08:55:11	IP Camera Disco...	N/A	▶	✓
13	Information	09-19-2014 08:55:14	HDD S.M.A.R.T.	N/A	▶	✓
14	Exception	09-19-2014 08:55:39	IP Camera Disco...	N/A	▶	✓

Total: 179 P: 1/2

Export Back

4. Playback interface:

The toolbar in the bottom part of the Playback interface can be used to control the playing process.



9.1.6. Playing Back the External File

Perform the following steps to look up and play back files in the external devices.

Steps:

1. Enter the Tag Search interface: Menu> Playback
2. Select the External File in the drop-down list on the top-left side. The files are listed in the right-side list. You can click the “Refresh” button to refresh the file list.
3. Select and click the “>” button to play it back. And you can adjust the playback speed by clicking “>>” and “<<”.



9.2. Auxiliary Functions of Playback

9.2.1. Playing Back Frame by Frame

This function plays the video files frame by frame for checking the image details of the video when abnormal events happen.

Steps:

Go to the Playback interface.

If you choose the playback of the recording file: click the button “<<” until the speed changes to Single frame and one click on the playback screen represents the playback of one frame.

If you choose reverse playback of the recording file: click the button “<<” until the speed changes to Single frame and one click on the playback screen represents the reverse playback of one frame.

It is also feasible to use the button “||” in the toolbar.

9.2.2. Digital Zoom

Steps:

1. Click the “(magnifying glass with a plus)” button on the playback control bar to enter the Digital Zoom interface.
2. Use the mouse to draw a red rectangle and the image within it will be enlarged up to 16 times.



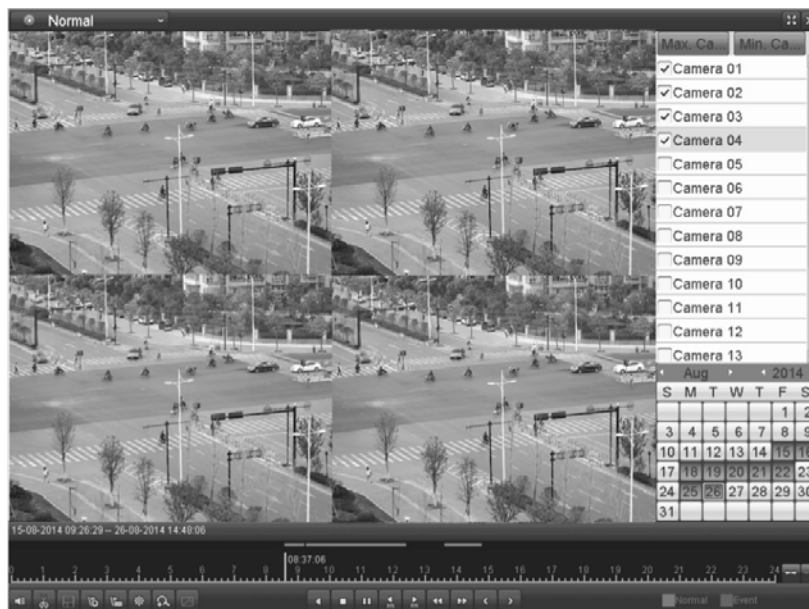
3. Right-click on the image to exit the digital zoom interface.

9.2.3. Reverse the Playback of Multi-channel

You can play back the recording files of multi-channel reversely. Up to 16-ch (with 1280*720 resolution) simultaneous reverse playback is supported; up to 4-ch (with 1920*1080P resolution) simultaneous reverse playback is supported and up to 1-ch (with 2560*1920 resolution) reverse playback is supported.

Steps:

1. Enter the Playback interface: Menu> Playback
2. Check more than one checkbox to select multiple channels and click to select a date on the calendar.



3. Click “<” to play back the recording files reversely.

10. Backup

10.1. Backing up the Recording Files

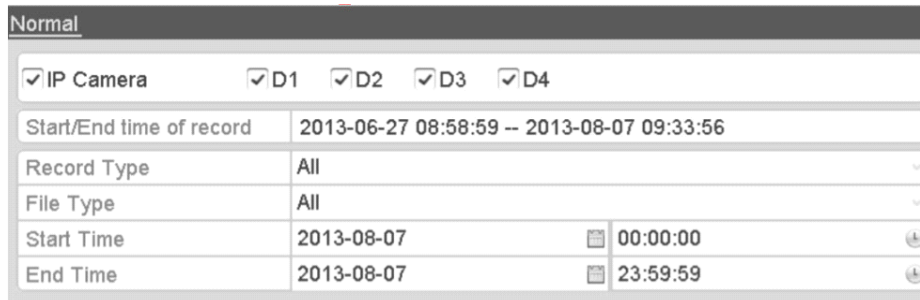
10.1.1. Backing up by Normal Video Search

The recording files can be backed up to various devices, such as USB devices (USB flash drives, USB HDDs, USB writer) and SATA device.

Backup using USB flash drives and USB HDDs:

Steps:

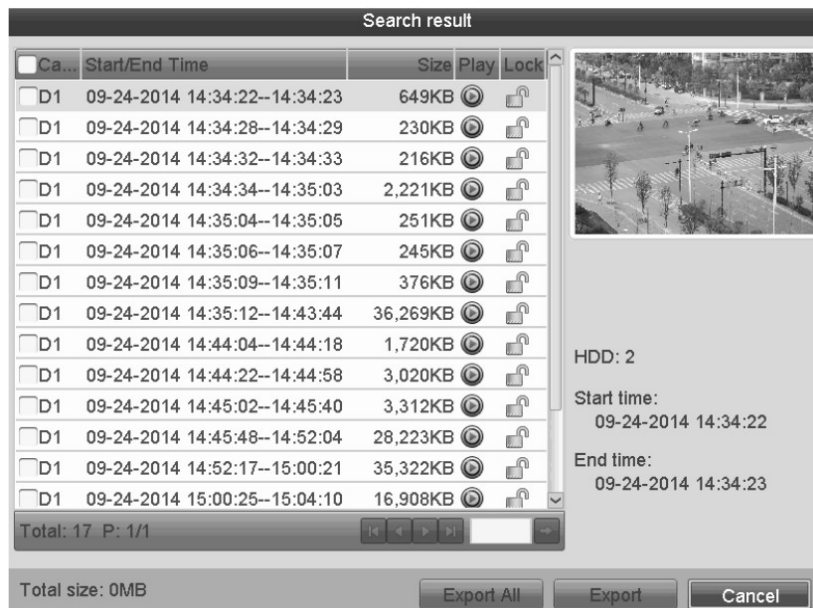
1. Enter the Export interface: Menu> Export> Normal
2. Set the search condition and click the "Search" button to enter the search result interface.



Normal	
<input checked="" type="checkbox"/> IP Camera	<input checked="" type="checkbox"/> D1 <input checked="" type="checkbox"/> D2 <input checked="" type="checkbox"/> D3 <input checked="" type="checkbox"/> D4
Start/End time of record	2013-06-27 08:58:59 -- 2013-08-07 09:33:56
Record Type	All
File Type	All
Start Time	2013-08-07 00:00:00
End Time	2013-08-07 23:59:59

3. Select the recording files you want to back up. Click ">" to play the recording file if you want to check it. Check the checkbox in front of the recording files you want to back up.

NOTE: The size of the currently selected files is displayed in the lower-left corner of the window.



Ca...	Start/End Time	Size	Play	Lock
<input type="checkbox"/> D1	09-24-2014 14:34:22--14:34:23	649KB	⏮	🔒
<input type="checkbox"/> D1	09-24-2014 14:34:28--14:34:29	230KB	⏮	🔒
<input type="checkbox"/> D1	09-24-2014 14:34:32--14:34:33	216KB	⏮	🔒
<input type="checkbox"/> D1	09-24-2014 14:34:34--14:35:03	2,221KB	⏮	🔒
<input type="checkbox"/> D1	09-24-2014 14:35:04--14:35:05	251KB	⏮	🔒
<input type="checkbox"/> D1	09-24-2014 14:35:06--14:35:07	245KB	⏮	🔒
<input type="checkbox"/> D1	09-24-2014 14:35:09--14:35:11	376KB	⏮	🔒
<input type="checkbox"/> D1	09-24-2014 14:35:12--14:43:44	36,269KB	⏮	🔒
<input type="checkbox"/> D1	09-24-2014 14:44:04--14:44:18	1,720KB	⏮	🔒
<input type="checkbox"/> D1	09-24-2014 14:44:22--14:44:58	3,020KB	⏮	🔒
<input type="checkbox"/> D1	09-24-2014 14:45:02--14:45:40	3,312KB	⏮	🔒
<input type="checkbox"/> D1	09-24-2014 14:45:48--14:52:04	28,223KB	⏮	🔒
<input type="checkbox"/> D1	09-24-2014 14:52:17--15:00:21	35,322KB	⏮	🔒
<input type="checkbox"/> D1	09-24-2014 15:00:25--15:04:10	16,908KB	⏮	🔒

Total: 17 P: 1/1

Total size: 0MB

Export All Export Cancel

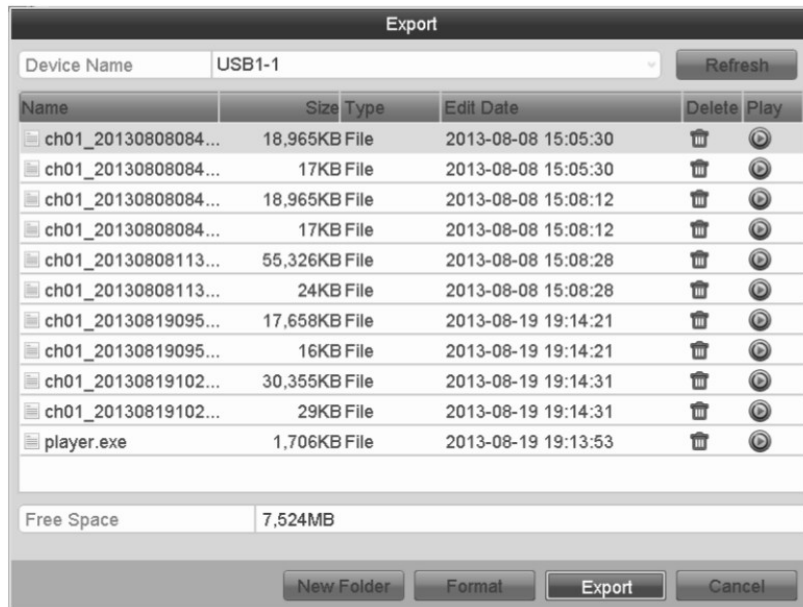
4. Export:

Click the "Export All" button to export all the recording files. Or you can select the recording files you want to back up, and click the "Export" button to enter the Export interface.

NOTE: If the inserted USB device is not recognised:

- Click the Refresh button.
- Reconnect device.
- If this does not work, this device might not be supported or defect.

You can also format USB flash drives or USB HDDs via the device.

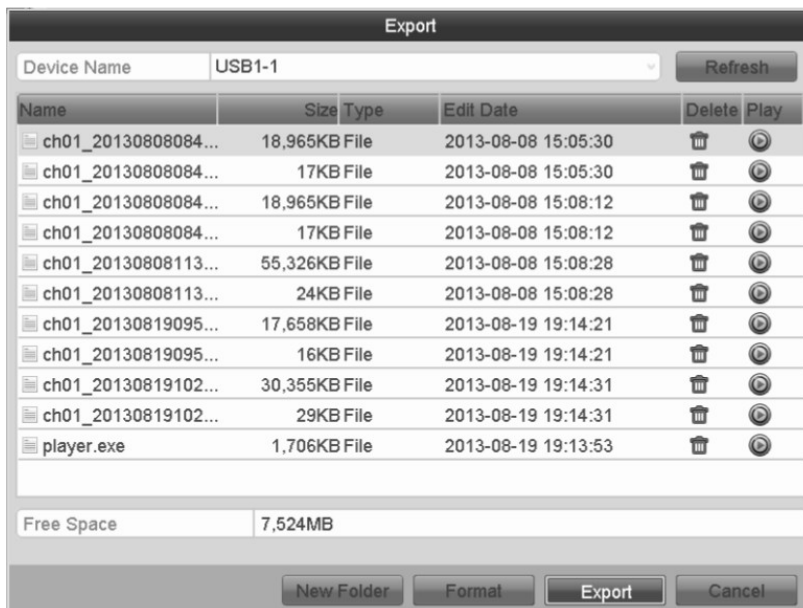


Stay in the Exporting interface until all recording files are exported and until the pop-up message box "Export finished" appears.

5. Check the backup result:

Choose the recording file in the Export interface and click the button ">" to check it.

NOTE: The Player player.exe will be exported automatically during the recording file export.



Backup using the USB DVD writer and SATA device:

Steps:

1. Enter the Export interface: Menu> Export> Normal
2. Set the search condition and click the "Search" button to enter the search result interface.

The screenshot shows a window titled "Normal" with several search criteria:

- IP Camera
- D1
- D2
- D3
- D4
- Start/End time of record: 2013-06-27 08:58:59 -- 2013-08-07 09:33:56
- Record Type: All
- File Type: All
- Start Time: 2013-08-07 00:00:00
- End Time: 2013-08-07 23:59:59

3. Select the recording files you want to back up. Click the ">" button to play the recording file if you want to check it. Check the checkbox in front of the recording files that you want to back up.

NOTE: The size of the currently selected files is displayed in the lower-left corner of the window.

The screenshot shows a window titled "Search result" with a table of files and a video preview on the right.

<input type="checkbox"/> Ca...	Start/End Time	Size	Play	Lock
<input type="checkbox"/> D1	09-24-2014 14:34:22--14:34:23	649KB	▶	🔒
<input type="checkbox"/> D1	09-24-2014 14:34:28--14:34:29	230KB	▶	🔒
<input type="checkbox"/> D1	09-24-2014 14:34:32--14:34:33	216KB	▶	🔒
<input type="checkbox"/> D1	09-24-2014 14:34:34--14:35:03	2,221KB	▶	🔒
<input type="checkbox"/> D1	09-24-2014 14:35:04--14:35:05	251KB	▶	🔒
<input type="checkbox"/> D1	09-24-2014 14:35:06--14:35:07	245KB	▶	🔒
<input type="checkbox"/> D1	09-24-2014 14:35:09--14:35:11	376KB	▶	🔒
<input type="checkbox"/> D1	09-24-2014 14:35:12--14:43:44	36,269KB	▶	🔒
<input type="checkbox"/> D1	09-24-2014 14:44:04--14:44:18	1,720KB	▶	🔒
<input type="checkbox"/> D1	09-24-2014 14:44:22--14:44:58	3,020KB	▶	🔒
<input type="checkbox"/> D1	09-24-2014 14:45:02--14:45:40	3,312KB	▶	🔒
<input type="checkbox"/> D1	09-24-2014 14:45:48--14:52:04	28,223KB	▶	🔒
<input type="checkbox"/> D1	09-24-2014 14:52:17--15:00:21	35,322KB	▶	🔒
<input type="checkbox"/> D1	09-24-2014 15:00:25--15:04:10	16,908KB	▶	🔒

Total: 17 P: 1/1

Total size: 0MB

Buttons: Export All, Export, Cancel

Video preview: HDD: 2, Start time: 09-24-2014 14:34:22, End time: 09-24-2014 14:34:23

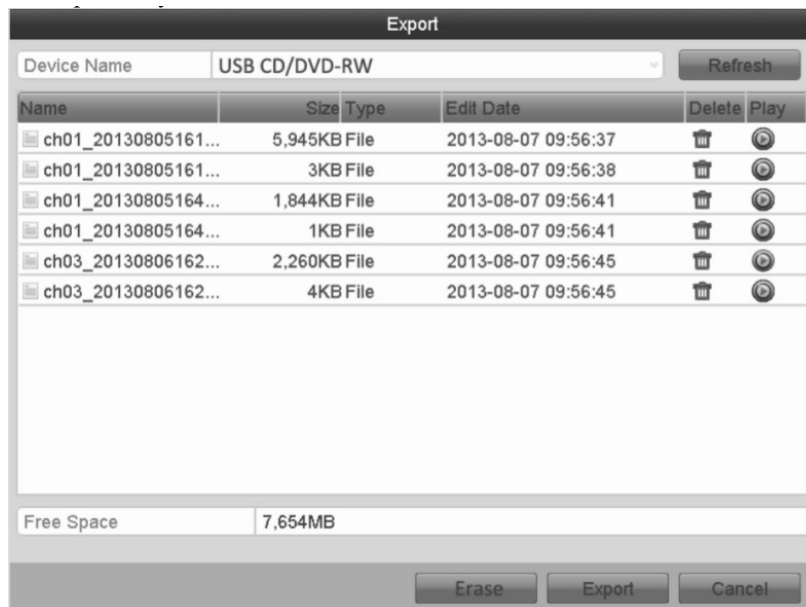
4. Export:

Click the "Export" button and start the backup.

NOTE: If the inserted USB writer or SATA writer is not recognised:

- Click the "Refresh" button.
- Reconnect the device.

If this does not work, this device might not be supported or defect.



Stay in the Exporting interface until all recording files are exported and until the pop-up message box "Export finished" appears.

5. Check the backup result. Choose the recording file in the Export interface and click the ">" button to check it.

10.1.2. Backing up by Event Search

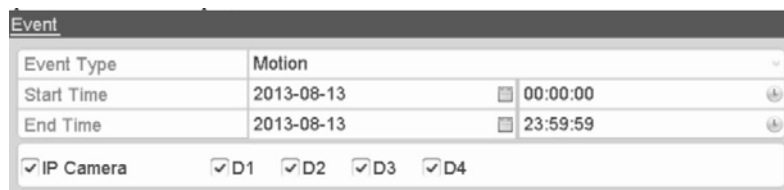
This function backs up event-related recording files using USB devices (USB flash drives, USB HDDs, USB writer) and/or a SATA device. Quick Backup and Normal Backup are supported.

Steps:

1. Enter the Export interface: Menu> Export> Event

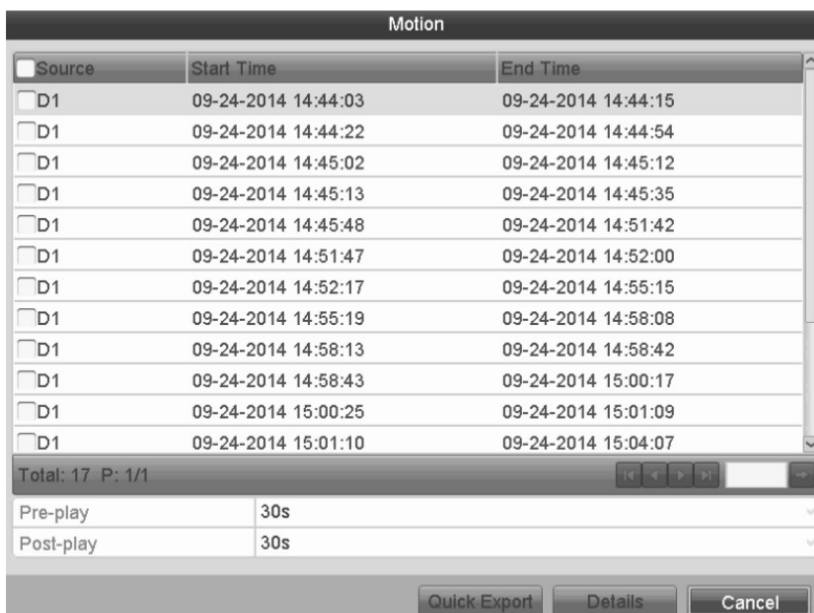
- 1) Select "Alarm Input" from the dropdown list of "Event Type".
- 2) Select the "Alarm Input No." and "Time".
- 3) Click "Search" button to enter the Search Result interface.

NOTE: Event types contain Alarm Input, Motion and VCA.

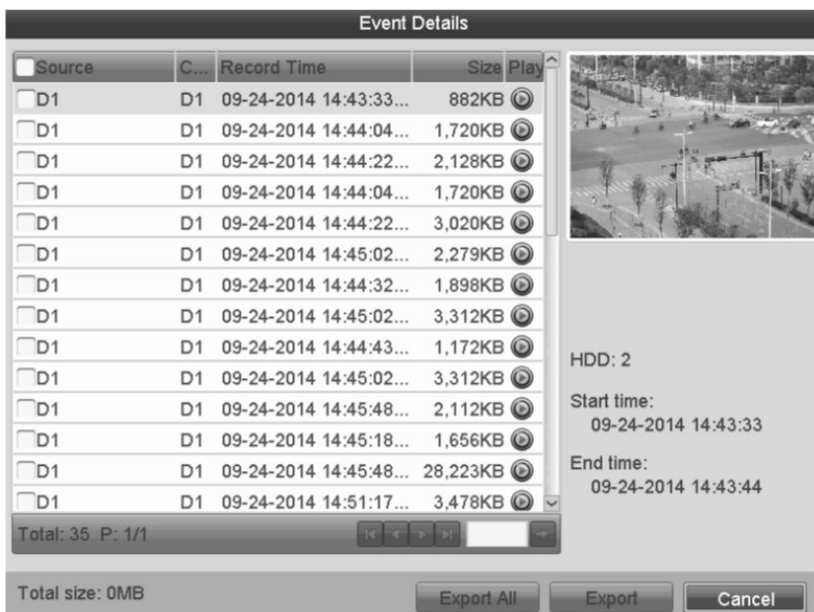


2. Select the recording files to export.

1) Clicking the "Quick Export" button will export the recording files of all channels triggered by the selected alarm input.



2) Click the "Details" button to view detailed information of the recording file, e.g. start time, end time, file size, etc.



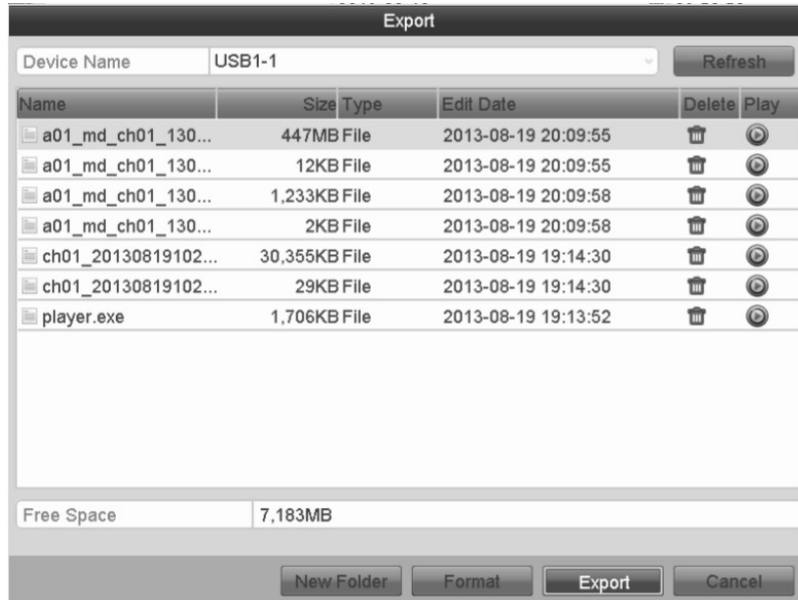
3. Export:

Click the "Export All" button to export all the recording files. Or you can select the recording files you want to back up, and click the "Export" button to enter the Export interface.

NOTE: If the inserted USB device is not recognised:

- Click the Refresh button.
- Reconnect the device.
- If this does not work, this device might not be supported or defect.

You can also format the USB flash drive or the USB HDDs via the device.



Stay in the Exporting interface until all recording files are exported and until the pop-up message "Export finished" appears.



4. Check the backup result.

NOTE: The Player player.exe will be exported automatically during recording file export.

10.1.3. Backing up Video Clips

You may also select video clips to export directly during Playback, using USB devices (USB flash drives, USB HDDs, USB writer) or a SATA writer.

Steps:

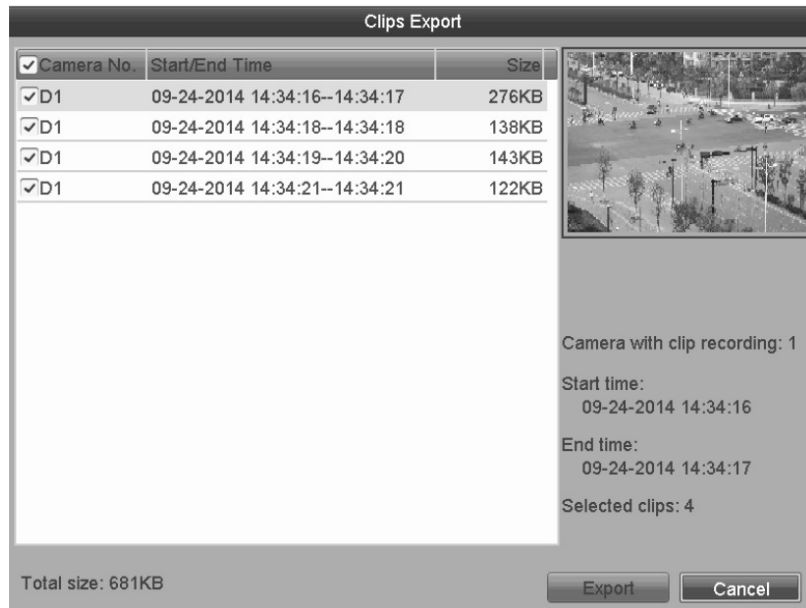
1. Enter the Playback interface:

Please refer to Chapter 6.1 Playing Back Recording Files.

2. During playback, use the buttons “(scissors)” and “(scissors with a tick)” in the playback toolbar to start or stop clipping the recording file(s).

3. Click the “(disc)” symbol to save the video clips. Otherwise the prompt for saving clips will pop up when you quit the playback interface.

NOTE: A maximum of 30 clips can be selected for each channel.



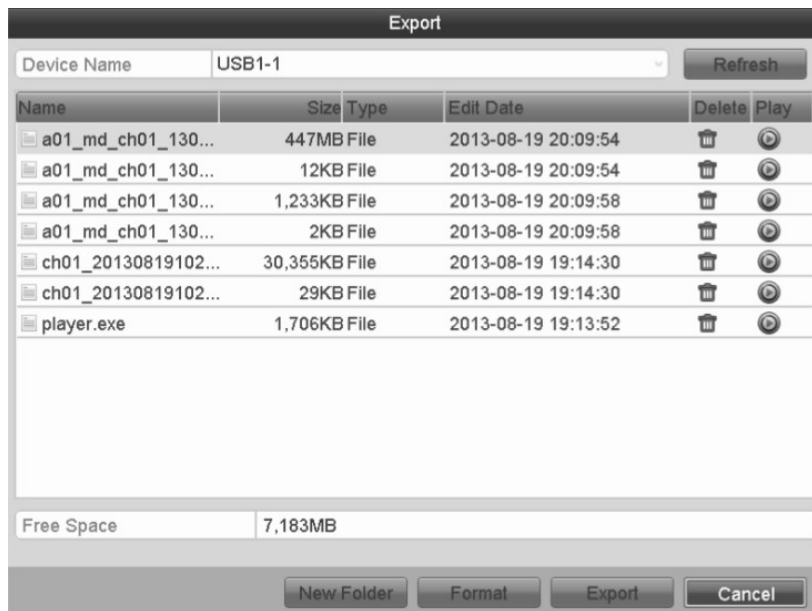
4. Export:

Click on the “Export” button and start the backup.

NOTE: If the inserted USB device is not recognised:

- Click the “Refresh” button.
- Reconnect the device.
- If this does not work, this device might not be supported or defect.

You can also format an USB flash drive or USB HDDs via the device.



Stay in the Exporting interface until all recording files are exported and the pop-up message “Export finished” appears.

5. Check the backup result.

NOTE: The Player player.exe will be exported automatically during the recording file export.

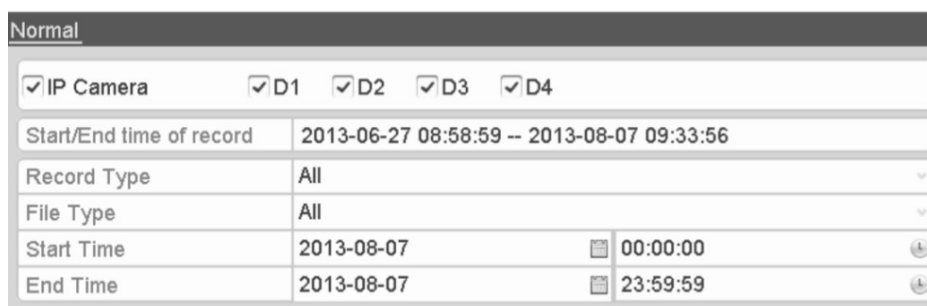
10.2. Managing the Backup Devices

Management of the USB flash drives and USB HDDs:

Steps:

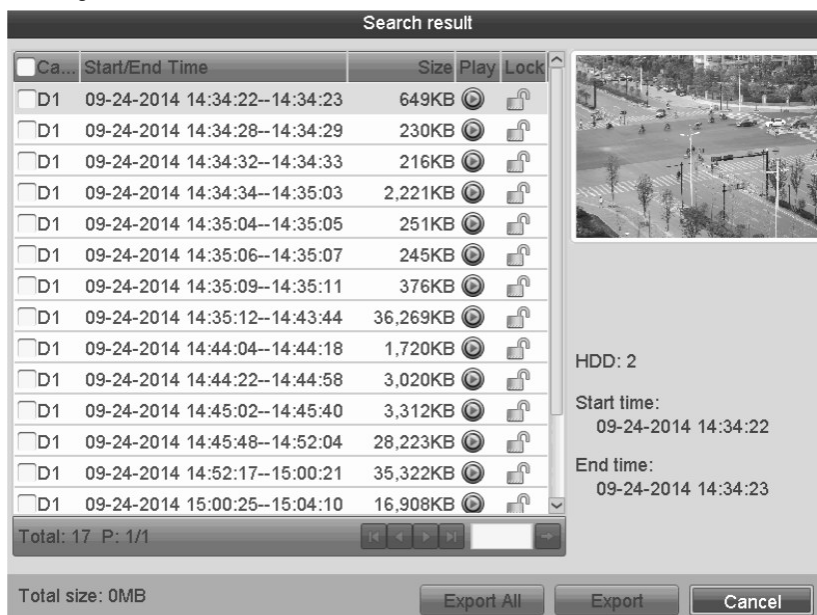
1. Enter the Search Result interface of the recording files: Menu> Export> Normal
Set the search condition and click the “Search” button to enter the Search Result interface.

NOTE: At least one channel needs to be selected.



2. Click on the "Export All" button to export all the recording files.
 Or you can select recording files you want to back up, and click the "Export" button to enter the Export interface.

NOTE: At least one recording file needs to be selected.

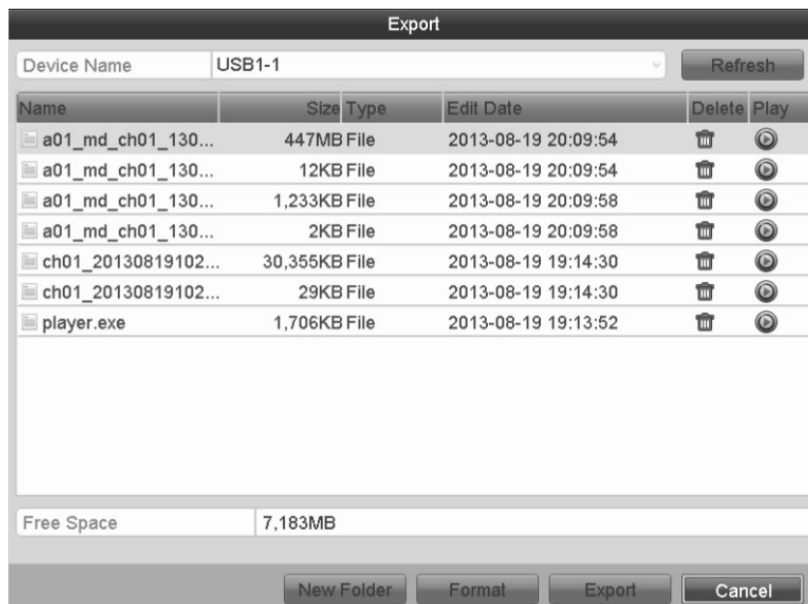


3. Backup device management:

Click on the "New Folder" button if you want to create a new folder on the backup device. Select a recording file or folder on the backup device and click the "(red bin)" button if you want to delete it. Select a recording file on the backup device and click the ">" button to play it. Click the "Format" button if you like to format the backup device.

NOTE: If the inserted USB device is not recognised:

- Click the "Refresh" button.
- Reconnect the device.
- If this does not work, this device might not be supported or defect.



Management of USB DVD-R/W writers:

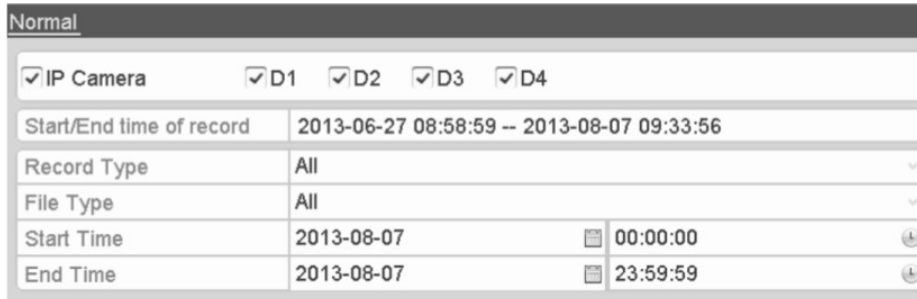
NOTE: DVD-R/W is not supported by GRN-G1004P und GRN-G1116P.

1. Enter the Search Result interface of the recording files:

Menu> Export> Normal

Set the search condition and click the "Search" button to enter the Search Result interface.

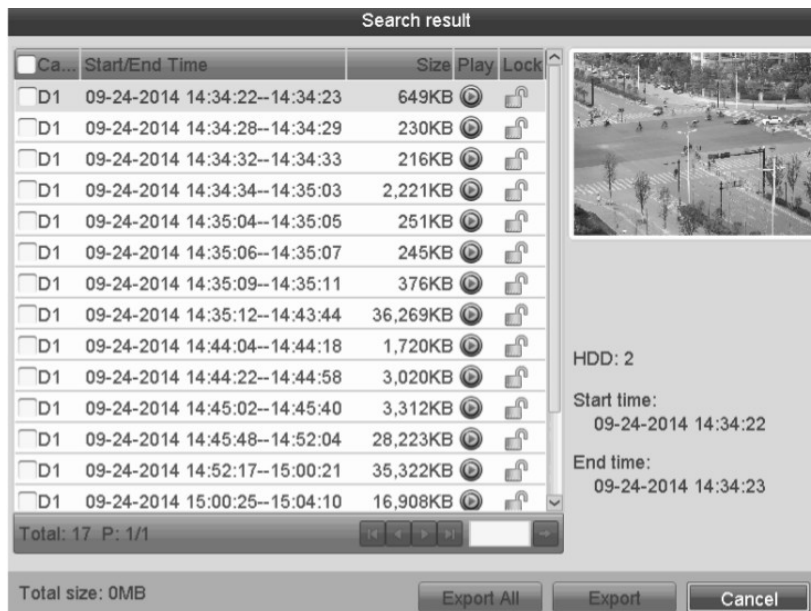
NOTE: At least one channel shall be selected.



Normal	
<input checked="" type="checkbox"/> IP Camera	<input checked="" type="checkbox"/> D1 <input checked="" type="checkbox"/> D2 <input checked="" type="checkbox"/> D3 <input checked="" type="checkbox"/> D4
Start/End time of record	2013-06-27 08:58:59 -- 2013-08-07 09:33:56
Record Type	All
File Type	All
Start Time	2013-08-07 00:00:00
End Time	2013-08-07 23:59:59

2. Select the recording files you want to back up. Click the "Export All" button to export all the recording files. Or you can select the recording files you want to back up, and click the "Export" button to enter the Export interface.

NOTE: At least one recording file shall be selected.



Ca...	Start/End Time	Size	Play	Lock
<input type="checkbox"/> D1	09-24-2014 14:34:22--14:34:23	649KB	⏮	🔒
<input type="checkbox"/> D1	09-24-2014 14:34:28--14:34:29	230KB	⏮	🔒
<input type="checkbox"/> D1	09-24-2014 14:34:32--14:34:33	216KB	⏮	🔒
<input type="checkbox"/> D1	09-24-2014 14:34:34--14:35:03	2,221KB	⏮	🔒
<input type="checkbox"/> D1	09-24-2014 14:35:04--14:35:05	251KB	⏮	🔒
<input type="checkbox"/> D1	09-24-2014 14:35:06--14:35:07	245KB	⏮	🔒
<input type="checkbox"/> D1	09-24-2014 14:35:09--14:35:11	376KB	⏮	🔒
<input type="checkbox"/> D1	09-24-2014 14:35:12--14:43:44	36,269KB	⏮	🔒
<input type="checkbox"/> D1	09-24-2014 14:44:04--14:44:18	1,720KB	⏮	🔒
<input type="checkbox"/> D1	09-24-2014 14:44:22--14:44:58	3,020KB	⏮	🔒
<input type="checkbox"/> D1	09-24-2014 14:45:02--14:45:40	3,312KB	⏮	🔒
<input type="checkbox"/> D1	09-24-2014 14:45:48--14:52:04	28,223KB	⏮	🔒
<input type="checkbox"/> D1	09-24-2014 14:52:17--15:00:21	35,322KB	⏮	🔒
<input type="checkbox"/> D1	09-24-2014 15:00:25--15:04:10	16,908KB	⏮	🔒

Total: 17 P: 1/1

Total size: 0MB

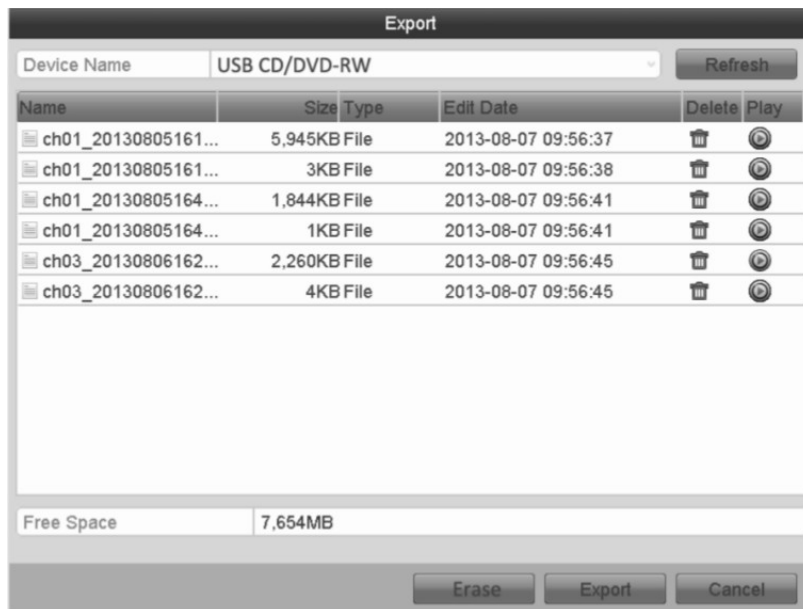
Export All Export Cancel

3. Backup device management:

Click the "Erase" button if you want to erase the files from a re-writable CD/DVD.

NOTE: Please note the following:

- There must be a re-writable CD/DVD when you make this operation.
- If the inserted USB writer or DVD-R/W is not recognised:
 - > Click the "Refresh" button.
 - > Reconnect the device.
 - > If this does not work, this device might not be supported or defect.



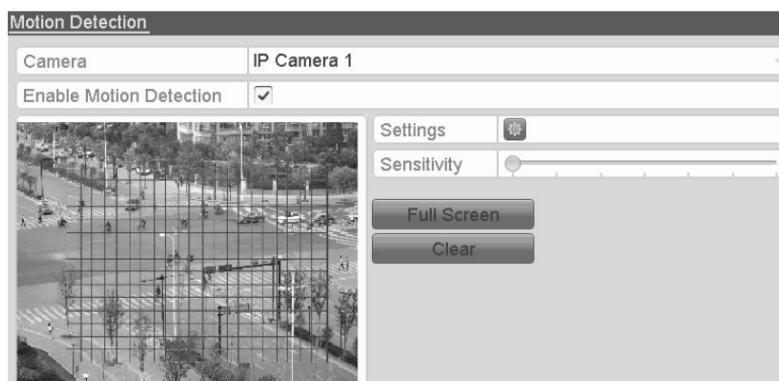
11. Alarm Settings

11.1. Setting the Motion Detection Alarm

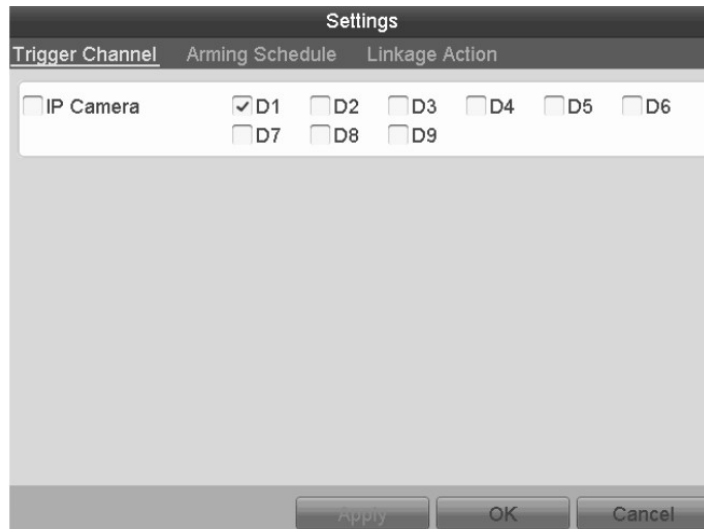
Steps:

1. Enter the Motion Detection interface of the Camera Management and choose a camera you want to set up the motion detection for: Menu> Camera> Motion
2. Set up the detection area and sensitivity. Tick "Enable Motion Detection", and use the mouse to draw detection area(s) and drag the sensitivity bar to set the sensitivity.

NOTE: By default, the motion detection is enabled and configured in full screen. Click the "(cogwheel)" button and set the alarm response actions.



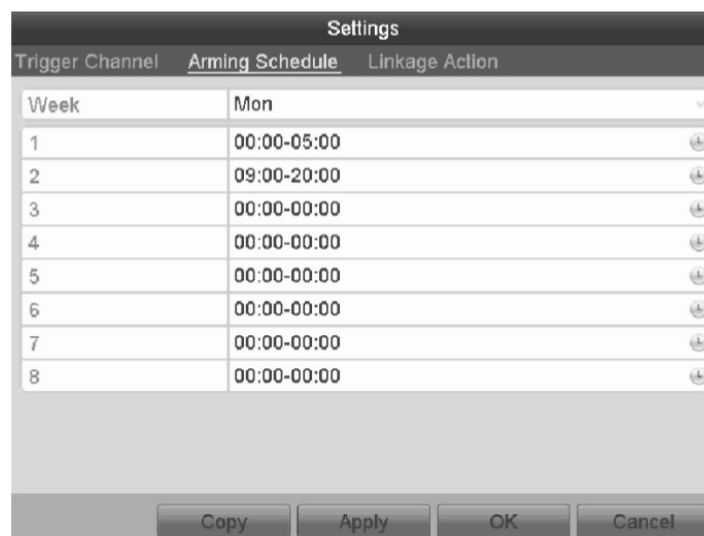
3. Click the “Trigger Channel” tab and select one or more channels which will start to record or turn to full-screen monitoring when the motion alarm is triggered, and click “Apply” to save the settings.



4. Set up the arming schedule of the channel:

- 1) Select the “Arming Schedule” tab to set the arming schedule of handling actions for the motion detection.
- 2) Choose one day of a week and up to eight time periods can be set within each day.
- 3) Click “Apply” to save the settings.

NOTE: Time periods shall not be repeated or overlapped.



5. Click the “Handling” tab to set up alarm response actions of the motion alarm (please refer to Chapter “Setting Alarm Response Actions”).

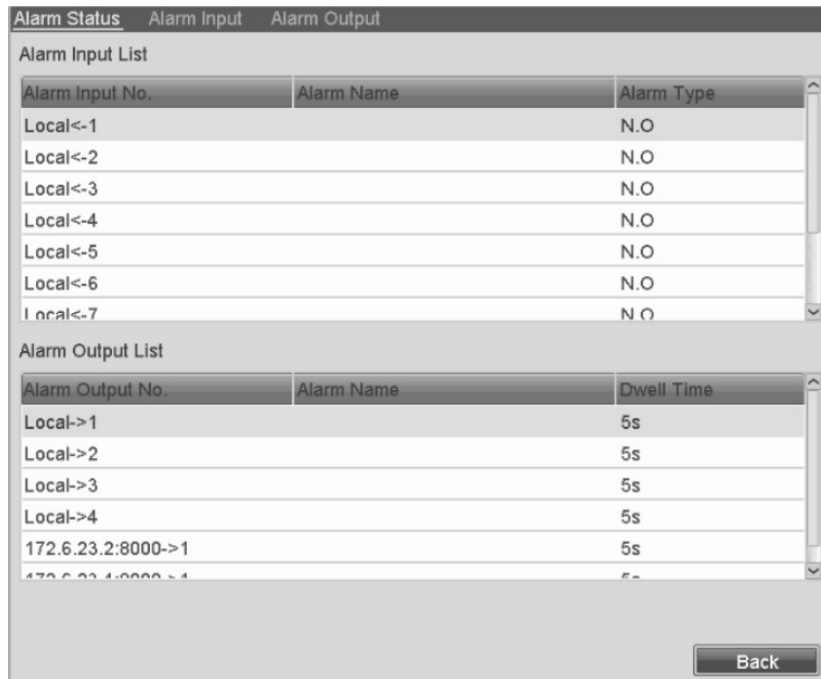
6. If you want to set the motion detection for another channel, repeat the above steps or just click “Copy” in the Motion Detection interface to copy the above settings to it.

11.2. Setting the Sensor Alarms

Here you can set the handling action of an external sensor alarm.

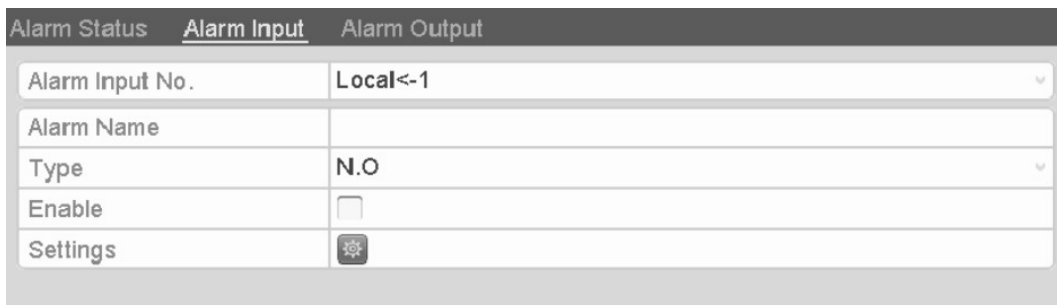
Steps:

1. Enter the Alarm Settings of System Configuration and select an alarm input: Menu> Configuration> Alarm
Select the "Alarm Input" tab to enter the Alarm Input Settings interface.



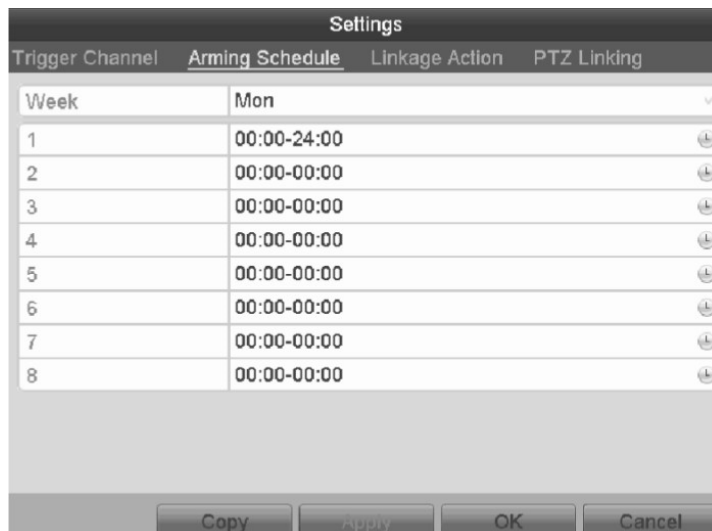
2. Set up the handling action of the selected alarm input.

Check the "Enable" checkbox and click the "Settings" button to set up its alarm response actions.



3. Select the "Trigger Channel" tab and select one or more channels which will start to record or turn to full-screen monitoring when an external alarm is input, and click "Apply" to save the settings.

4. Select the "Arming Schedule" tab to set the arming schedule of handling actions.



Choose one day of a week and max. eight time periods can be set within each day, and click “Apply” to save the settings.

NOTE: Time periods shall not be repeated or overlapped.

Repeat the above steps to set up the arming schedule for other days of a week. You can also use the “Copy” button to copy an arming schedule to other days.

5. Select the “Linkage Action” tab to set up alarm response actions for the alarm input (please refer to Chapter “Setting Alarm Response Actions”).

6. If necessary, select the “PTZ Linking” tab and set the PTZ linkage of the alarm input. Set the PTZ linking parameters and click “OK” to complete the settings of the alarm input.

NOTE: Please check whether the PTZ or speed dome supports PTZ linkage.

One alarm input can trigger presets, patrol or pattern of more than one channel. But presets, patrols and patterns are exclusive.

The screenshot shows a dialog box titled "Settings" with four tabs: "Trigger Channel", "Arming Schedule", "Linkage Action", and "PTZ Linking". The "PTZ Linking" tab is active. It contains a table with the following data:

PTZ Linking	IP Camera 1
Call Preset	<input checked="" type="radio"/>
Preset	18
Call Patrol	<input type="radio"/>
Patrol	1
Call Pattern	<input type="radio"/>
Pattern	1

At the bottom of the dialog box are three buttons: "Apply", "OK", and "Cancel".

7. If you want to set the handling action of another alarm input, repeat the above steps. Or you can click the “Copy” button on the Alarm Input Setup interface and check the checkbox of alarm inputs to copy the settings to them.

The screenshot shows a dialog box titled "Copy Alarm Input to". It contains a table with the following data:

Alarm Input No.	Alarm Name
<input type="checkbox"/>	Local<-1
<input type="checkbox"/>	Local<-2
<input type="checkbox"/>	Local<-3
<input type="checkbox"/>	Local<-4
<input type="checkbox"/>	Local<-5
<input type="checkbox"/>	Local<-6
<input type="checkbox"/>	Local<-7
<input type="checkbox"/>	Local<-8
<input type="checkbox"/>	172.6.23.2:8000<-1
<input type="checkbox"/>	172.6.23.4:8000<-1

At the bottom of the dialog box are two buttons: "OK" and "Cancel".

11.3. Detecting a Video Loss Alarm

This function is for detecting video loss of a channel and taking alarm response action(s).

Steps:

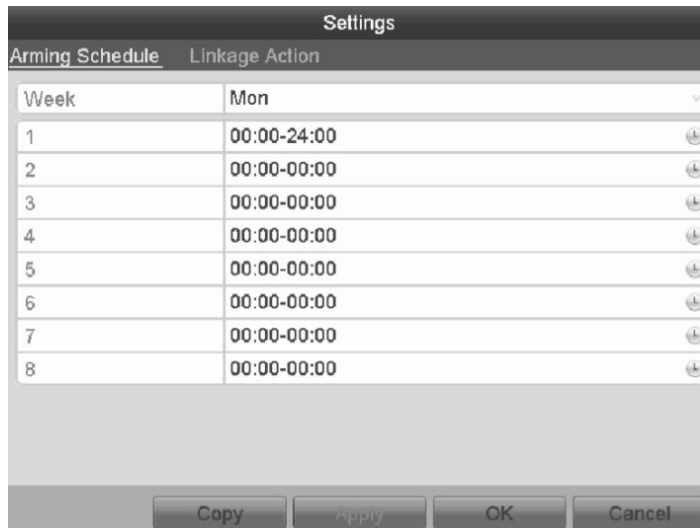
1. Enter the "Video Loss" interface of the Camera Management and select a channel you want to detect:
Menu> Camera> Video Loss



2. Set up the handling action for video loss.
Check the checkbox of "Enable Video Loss Alarm", and click the "[cogwheel]" button to set up the handling action of video loss.
3. Set up the arming schedule of the handling actions.

- 1) Select the "Arming Schedule" tab to set the channel's arming schedule.
- 2) Choose one day of a week and up to eight time periods can be set within each day.
- 3) Click "Apply" button to save the settings.

NOTE: Time periods shall not be repeated or overlapped.



4. Select the "Linkage Action" tab to set up the alarm response action of video loss (please refer to Chapter "Setting Alarm Response Actions").
5. Click the "OK" button to complete the video loss settings of the channel.

11.4. Handling an Exceptions Alarm

The Exception Settings refer to the handling action of various exceptions, e.g.


- HDD Full: The HDD is full.
- HDD Error: Writing HDD error or unformatted HDD.
- Network Disconnected: Disconnected network cable.
- IP Conflicted: Duplicated IP address.
- Illegal Login: Incorrect user ID or password.
- Record Exception: No space for saving recorded files.
- PoE Power Overload: The power consumption of the connected cameras via the PoE interface exceeds the maximum PoE power.

NOTE: PoE Power Overload is only supported by GRN-G1004P und GRN-G1116P.

Steps:

Enter the Exception interface of System Configuration and handle various exceptions: Menu> Configuration> Exceptions

Please refer to Chapter "Setting Alarm Response Actions" for detailed alarm response actions.

Exception	
Enable Event Hint	<input checked="" type="checkbox"/>
Event Hint Settings	
Exception Type	HDD Full
Audible Warning	<input type="checkbox"/>
Notify Surveillance Center	<input type="checkbox"/>
Send Email	<input type="checkbox"/>
Trigger Alarm Output	<input type="checkbox"/>

11.5. Setting Alarm Response Actions


Alarm response actions will be activated when an alarm or exception occurs, including Event Hint Display, Full Screen Monitoring, Audible Warning (buzzer), Notify Surveillance Center, Upload Picture to FTP, Trigger Alarm Output and Send Email.

Event Hint Display:

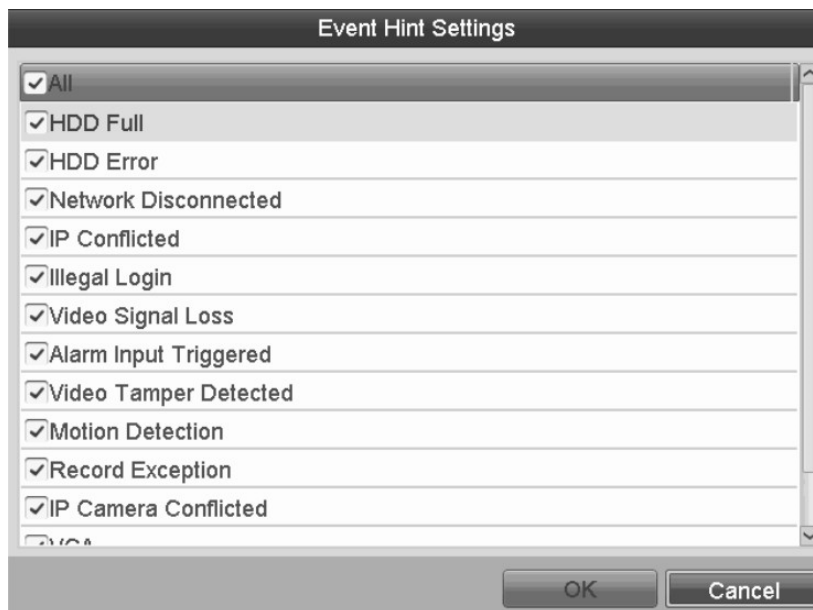
When an event or exception happens, a hint can be displayed on the lower-left corner of the live view image. And you can click on the hint icon to check the details. Furthermore, the event to be displayed is configurable.

Steps:

1. Enter the Exception settings interface: Menu> Configuration> Exceptions
2. Check the checkbox of "Enable Event Hint".

Exception	
Enable Event Hint	<input checked="" type="checkbox"/>
Event Hint Settings	
Exception Type	HDD Full
Audible Warning	<input type="checkbox"/>
Notify Surveillance Center	<input type="checkbox"/>
Send Email	<input type="checkbox"/>
Trigger Alarm Output	<input type="checkbox"/>

3. Click the “(cogwheel)” button to set the type of event to be displayed in the image.



4. Click the “OK” button to finish the settings.

Full Screen Monitoring:

When an alarm is triggered, the local monitor (VGA and HDMI(Trademark) monitor) displays in full screen the video image from the alarming channel configured for full screen monitoring.

If the alarms are triggered simultaneously in several channels, their full-screen images will be switched at an interval of 10 seconds (default dwell time). A different dwell time can be set by going to Menu> Configuration> Live View> Full Screen Monitoring Dwell Time.

Auto-switch will terminate once the alarm stops and you will be taken back to the Live View interface.

NOTE: You must select during the “Trigger Channel” settings the channel(s) you want to create the full screen monitoring for.

Audible Warning:

Triggers an audible beep when an alarm is detected.

Notify Surveillance Center:

Sends an exception or alarm signal to the remote alarm host when an event occurs. The alarm host refers to the PC installed via a Remote Client.

NOTE: The alarm signal will be transmitted automatically at detection mode when the remote alarm host is configured. Please refer to Chapter “Configuring a Remote Alarm Host” for details of alarm host configuration.

Email Linkage:

Send an email with alarm information to a user or users when an alarm is detected. Please refer to Chapter 9.2.9 for details of the Email configuration.

Trigger Alarm Output:

Triggers an alarm output when an alarm is triggered.

1. Enter the Alarm Output interface: Menu > Configuration > Alarm > Alarm Output

Select an alarm output and set the alarm name and dwell time. Click the "Schedule" button to set the arming schedule of alarm output.

NOTE: If "Manually Clear" is selected in the dropdown list of Dwell Time, you can clear it only by going to Menu > Manual > Alarm.

Alarm Output No.	Local->1
Alarm Name	
Dwell Time	Manually Clear
Settings	

2. Set up the arming schedule of the alarm output.

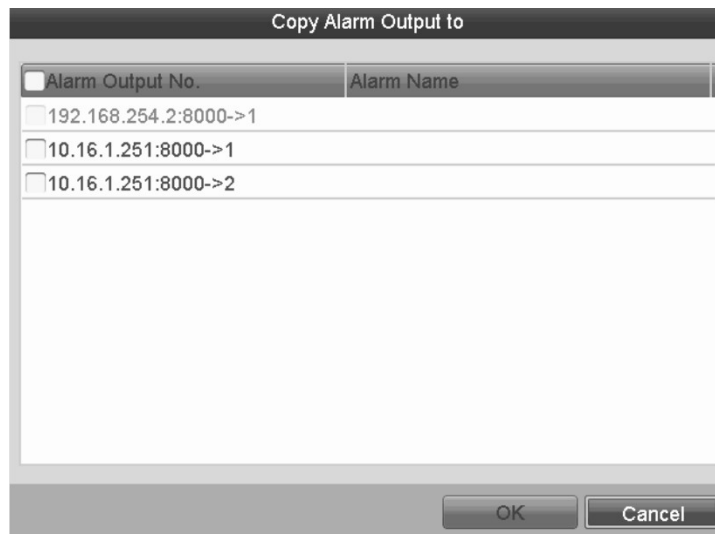
Choose one day of a week and up to 8 time periods can be set within each day.

NOTE: Time periods shall not be repeated or overlapped.

Week	Mon
1	00:00-24:00
2	00:00-00:00
3	00:00-00:00
4	00:00-00:00
5	00:00-00:00
6	00:00-00:00
7	00:00-00:00
8	00:00-00:00

Buttons: Copy, Apply, OK, Cancel

3. Repeat the above steps to set up the arming schedule of other days of a week. You can also use the “Copy” button to copy an arming schedule to other days. Click the “OK” button to complete the video tampering settings of the alarm output No.
4. You can also copy the above settings to another channel.



11.6. Triggering or Clearing an Alarm Output Manually

The sensor alarm can be triggered or cleared manually. If “Manually Clear” is selected in the dropdown list of the dwell time of an alarm output, the alarm can be cleared only by clicking the “Clear” button in the following interface.

Steps:

1. Select the alarm output you want to trigger or clear and make related operations for: Menu> Manual> Alarm

Alarm		
Alarm Output No.	Alarm Name	Trigger
Local->1		No
Local->2		No
Local->3		No
Local->4		No
172.6.23.2:8000->1		No
172.6.23.4:8000->1		No

2. Click the “Trigger”/“Clear” button if you want to trigger or clear an alarm output.
3. Click the “Trigger All” button if you want to trigger all alarm outputs.
4. Click the “Clear All” button if you want to clear all alarm outputs.

12. Network Settings

12.1. Configuring the General Settings

The network settings must be properly configured before you operate the NVR over the network.

Steps:

1. Enter the Network Settings interface: Menu> Configuration> Network
2. Select the "General" tab.

For GRN-G1004P and GRN-G1116P:

NIC Type	10M/100M Self-adaptive
Enable DHCP	<input type="checkbox"/>
IPv4 Address	10 .16 .1 .233
IPv4 Subnet Mask	255 .255 .255 .0
IPv4 Default Gateway	. . .
IPv6 Address 1	fe80::209:5ff:fe05:90e/64
IPv6 Address 2	
IPv6 Default Gateway	
MAC Address	00:09:05:05:09:0e
MTU(Bytes)	1500
Preferred DNS Server	
Alternate DNS Server	
Internal NIC IPv4 Address	192 .168 .254 .1

For GRN-M1116N and GRN-M1232N:

NIC Type	10M/100M/1000M Self-adaptive
Enable DHCP	<input type="checkbox"/>
IPv4 Address	172 .6 .23 .180
IPv4 Subnet Mask	255 .255 .255 .0
IPv4 Default Gateway	172 .6 .23 .1
IPv6 Address 1	fe80::240:48ff:feb8:c566/64
IPv6 Address 2	
IPv6 Default Gateway	
MAC Address	00:40:48:b8:c5:66
MTU(Bytes)	1500
Preferred DNS Server	
Alternate DNS Server	

3. In the "General Settings" interface, you can configure the following settings: Working Mode, NIC Type, IPv4 Address, IPv4 Gateway, MTU and DNS Server. If the DHCP server is available, you can click the checkbox of "DHCP" to automatically obtain an IP address and other network settings from that server.

NOTE:

- For the models which have the PoE or built-in switch network interfaces, the internal NIC IPv4 address should be configured for the cameras connecting to the PoE or built-in switch network interface of the NVR.
- The valid value range of MTU is between 500 ~ 9676.

4. After having configured the general settings, click the "Apply" button to save the settings.

12.2. Configuring the Advanced Settings

12.2.1. Configuring the PPPoE Settings

Your NVR also allows access by Point-to-Point Protocol over Ethernet (PPPoE).

Steps:

1. Enter the "Network Settings" interface: Menu> Configuration> Network
2. Select the "PPPoE" tab to enter the PPPoE Settings interface.

Enable PPPOE	<input type="checkbox"/>
User Name	
Password	

3. Check the "Enable PPPoE" checkbox to enable this feature.
4. Enter the "User Name", and "Password" for PPPoE access.

NOTE: The User Name and Password should be assigned by your ISP.

5. Click the "Apply" button to save and exit the interface.
6. After successfully finishing the settings, the system asks you to reboot the device to enable the new settings, and the PPPoE dial-up will be automatically connected after the reboot. You can go to Menu> Maintenance> System Info> Network interface to view the status of the PPPoE connection. Please refer to Chapter "Viewing System Information" for the PPPoE status.

12.2.2. Configuring the Extranet Access

You can choose the access to the device by DDNS through the settings on the "Extranet Access" menu.

12.2.3. Configuring DDNS

If your NVR is set to use PPPoE as its default network connection, you may set Dynamic DNS (DDNS) to be used for network access. Prior registration with your ISP is required before configuring the system to use DDNS.

Steps:

1. Enter the Network Settings interface: Menu> Configuration> Network
2. Select the "Extranet Access" tab to enter the DDNS Settings interface.
3. Check the "Enable DDNS" checkbox to enable this feature.
4. Select "DDNS Type". 4 different DDNS types are selectable: IP Server, DynDNS, PeanutHull and NO-IP.

- IP Server: Enter the "Server Address" for the IP Server.

Enable DDNS	<input checked="" type="checkbox"/>
DDNS Type	IP Server
Server Address	
Device Domain Name	
Status	Offline
User Name	
Password	
Confirm	

- DynDNS:

- 1) Enter the "Server Address" for DynDNS (i.e. members.dyndns.org).
- 2) In the NVR Domain Name text field, enter the domain obtained from the DynDNS website.
- 3) Enter the "User Name" and "Password" registered on the DynDNS website.

Enable DDNS	<input checked="" type="checkbox"/>
DDNS Type	DynDNS
Server Address	
Device Domain Name	
Status	Offline
User Name	
Password	
Confirm	

- PeanutHull: Enter the "User Name" and "Password" obtained from the PeanutHull website.

Enable DDNS	<input checked="" type="checkbox"/>
DDNS Type	PeanutHull
Server Address	
Device Domain Name	
Status	Offline
User Name	
Password	
Confirm	

- NO-IP:

Enter the account information in the corresponding fields. Refer to the DynDNS settings.

- 1) Enter the "Server Address" for NO-IP.
- 2) In the NVR Domain Name text field, enter the domain obtained from the NO-IP website (www.no-ip.com).
- 3) Enter the "User Name" and "Password" registered on the NO-IP website.

Enable DDNS	<input checked="" type="checkbox"/>
DDNS Type	NO-IP
Server Address	
Device Domain Name	
Status	Offline
User Name	
Password	
Confirm	

5. Click the "Apply" button to save the settings. After setting all the required parameters for the DDNS, you can view the connecting status of the device by checking the "Status" information.

12.2.4. Configuring the NTP Server

Ensure that the network connection of the PC (running FTP server) and the device is valid and correct. Run the FTP server on the PC and copy the firmware into the corresponding directory of your PC.

NOTE: Refer to the user manual of the FTP server to set the FTP server on your PC and put the firmware file into the directory as required.

Steps:

1. Enter the Network Settings interface: Menu> Configuration> Network
2. Select the "NTP" tab to enter the NTP Settings interface.

Enable NTP	<input checked="" type="checkbox"/>
Interval (min)	60
NTP Server	210.72.145.44
NTP Port	123

3. Check the "Enable NTP" checkbox to enable this feature.
4. Configure the following NTP settings:

- Interval: Time interval between the two synchronising actions with the NTP server. The unit is minute.
- NTP Server: IP address of the NTP server.
- NTP Port: Port of the NTP server.

5. Click the "Apply" button to save and exit the interface.

NOTE: The time synchronisation interval can be set from 1 to 10080 min, and the default value is 60min. If the NVR is connected to a public network, you should use a NTP server that has a time synchronisation function, such as the server at the National Time Center (IP Address: 210.72.145.44). If the NVR is setup in a more customised network, the NTP software can be used to establish a NTP server used for time synchronisation.

12.2.5. Configuring SNMP

You can use the SNMP protocol to get the device status and parameters related information.

Steps:

1. Enter the Network Settings interface: Menu> Configuration> Network
2. Select the "SNMP" tab to enter the SNMP Settings interface.

Enable SNMP	<input checked="" type="checkbox"/>
SNMP Version	V2
SNMP Port	161
Read Community	public
Write Community	private
Trap Address	<input type="text"/>
Trap Port	162

3. Check the “Enable SNMP” checkbox to enable this feature.

4. Configure the following SNMP settings:

- Trap Address: IP Address of the SNMP host.
- Trap Port: Port of the SNMP host.

5. Click the “Apply” button to save and exit the interface.

NOTE: Before setting the SNMP, please download the SNMP software and manage to receive the device information via the SNMP port. By setting the Trap Address, the NVR is allowed to send the alarm event and exception message to the surveillance center.

12.2.6. Configuring the Remote Alarm Host

With a remote alarm host configured, the NVR will send the alarm event or exception message to the host when an alarm is triggered. The remote alarm host must have the Network Video Surveillance software installed.

Steps:

1. Enter the Network Settings interface: Menu> Configuration> Network
2. Select the “More Settings” tab to enter the More Settings interface, as shown below.

Alarm Host IP	
Alarm Host Port	0
Server Port	8000
HTTP Port	80
Multicast IP	
RTSP Port	554

3. Enter the “Alarm Host IP” and “Alarm Host Port” in the text fields. The “Alarm Host IP” refers to the IP address of the remote PC on which the Network Video Surveillance Software (SCMS) is installed, and the “Alarm Host Port” must be the same as the alarm monitoring port configured in the software.

4. Click the “Apply” button to save and exit the interface.

12.2.7. Configuring Multicast

The multicast can be configured to realise a live view for more than 128 connections through the network for the device.

A multicast address spans the Class-D IP range of 224.0.0.0 to 239.255.255.255. It is recommended to use an IP address ranging from 239.252.0.0 to 239.255.255.255.

Steps:

1. Enter the Network Settings interface: Menu> Configuration> Network
2. Select the “More Settings” tab to enter the More Settings interface
3. Set the “Multicast IP”. When adding a device to the Network Video Surveillance Software, the multicast address must be the same as the NVR’s multicast IP.

Server Port	8000
HTTP Port	80
Multicast IP	

4. Click the “Apply” button to save and exit the interface.

NOTE: The multicast function should be supported by the network switch to which the NVR is connected.

12.2.8. Configuring RTSP

The RTSP (Real Time Streaming Protocol) is a network control protocol designed for use in communication systems to control streaming media servers.

Steps:

1. Enter the Network Settings menu: Menu> Configuration> Network
2. Select the "More Settings" tab to enter the "More Settings" menu.

RTSP Port	554
-----------	-----

3. Enter the RTSP port in the text field of "RTSP Service Port". The default RTSP port is 554, and you can change it according to different requirements.
4. Click the "Apply" button to save and exit the menu.

12.2.9. Configuring the Server and HTTP Ports

You can change the server and HTTP ports in the Network Settings menu. The default server port is 8000 and the default HTTP port is 80.

Steps:

1. Enter the Network Settings interface: Menu> Configuration> Network
2. Select the "More Settings" tab to enter the "More Settings" interface.
3. Enter the new "Server Port" and "HTTP Port".

Server Port	8000
HTTP Port	80
Multicast IP	

4. Enter the Server Port and HTTP Port in the text fields. The default Server Port is 8000 and the HTTP Port is 80, and you can change them according to different requirements.
5. Click the "Apply" button to save and exit the interface.

NOTE: The Server Port should be set to the range of 2000-65535 and it is used for remote client software access. The HTTP port is used for remote web browser access.

12.2.10. Configuring Email

The system can be configured to send an Email notification to all designated users if an alarm or motion event is detected or the administrator password is changed.

Before configuring the Email settings, the NVR must be connected to a local area network (LAN) that maintains an SMTP mail server. The network must also be connected to either an intranet or the Internet depending on the location of the e-mail accounts to which you want to send the notification.

Steps:

1. Enter the Network Settings interface: Menu> Configuration> Network
2. Set the "IPv4 Address", "IPv4 Subnet Mask", "IPv4 Gateway" and the "Preferred DNS Server" in the Network Settings menu.

NIC Type	10M/100M Self-adaptive
Enable DHCP	<input type="checkbox"/>
IPv4 Address	10 .16 .1 .233
IPv4 Subnet Mask	255 .255 .255 .0
IPv4 Default Gateway	10 .16 .1 .254
IPv6 Address 1	fe80::209:5ff:fe05:90e/64
IPv6 Address 2	
IPv6 Default Gateway	
MAC Address	00:09:05:05:09:0e
MTU(Bytes)	1500
Preferred DNS Server	10.1.7.88
Alternate DNS Server	
Internal NIC IPv4 Address	192 .168 .254 .1

3. Click "Apply" to save the settings.
4. Select the "Email" tab to enter the Email Settings interface.

Enable Server Authentic...	<input type="checkbox"/>
User Name	
Password	
SMTP Server	
SMTP Port	25
Enable SSL	<input type="checkbox"/>
Sender	
Sender's Address	
Select Receivers	Receiver 1
Receiver	
Receiver's Address	
Enable Attached Picture	<input type="checkbox"/>
Interval	2s

5. Configure the following Email settings:

- Enable Server Authentication (optional): Check the checkbox to enable the server authentication feature.
- User Name: The user account of the sender's Email for SMTP server authentication.
- Password: The password of the sender's Email for SMTP server authentication.
- SMTP Server: The SMTP Server IP address or host name (e.g., smtp.yourprovider.com).
- SMTP Port No.: The SMTP port. The default TCP/IP port used for SMTP is 25.
- Enable SSL (optional): Click the checkbox to enable SSL if required by the SMTP server.
- Sender: The name of the sender.
- Sender's Address: The Email address of the sender.
- Select Receivers: Select the receiver. Up to 3 receivers can be configured.
- Receiver: The name of the user to be notified.
- Receiver's Address: The Email address of the user to be notified.
- Enable Attached Pictures: Check the checkbox of "Enable Attached Picture" if you want to send an email with attached alarm images. The interval is the time of two adjacent alarm images. You can also set SMTP port and enable SSL here.
- Interval: The interval refers to the time between two actions of sending attached pictures.
- E-Mail Test: Sends a test message to verify that the SMTP server can be reached.

6. Click the "Apply" button to save the Email settings.

7. You can click the "Test" button to test whether your Email settings work. The corresponding Attention message box will pop up.



12.2.11. Configuring NAT

Two ways are provided for port mapping to realise the remote access via the cross-segment network, UPnP™ and manual mapping.

UPnP™:

Universal Plug and Play (UPnP™) can permit the device to seamlessly discover the presence of other network devices on the network and to establish functional network services for data sharing, communications, etc. You can use the UPnP™ function to enable the fast connection of the device to the WAN via a router without port mapping.

Two ways are provided for port mapping to realise the remote access via the cross-segment network, UPnP™ and manual mapping.

UPnP™:

Universal Plug and Play (UPnP™) can permit the device to seamlessly discover the presence of other network devices on the network and to establish functional network services for data sharing, communications, etc. You can use the UPnP™ function to enable the fast connection of the device to the WAN via a router without port mapping.

Two ways are provided for port mapping to realise the remote access via the cross-segment network, UPnP™ and manual mapping.

UPnP™:

Universal Plug and Play (UPnP™) can permit the device to seamlessly discover the presence of other network devices on the network and to establish functional network services for data sharing, communications, etc. You can use the UPnP™ function to enable the fast connection of the device to the WAN via a router without port mapping.

Two ways are provided for port mapping to realise the remote access via the cross-segment network, UPnP™ and manual mapping.

UPnP™:

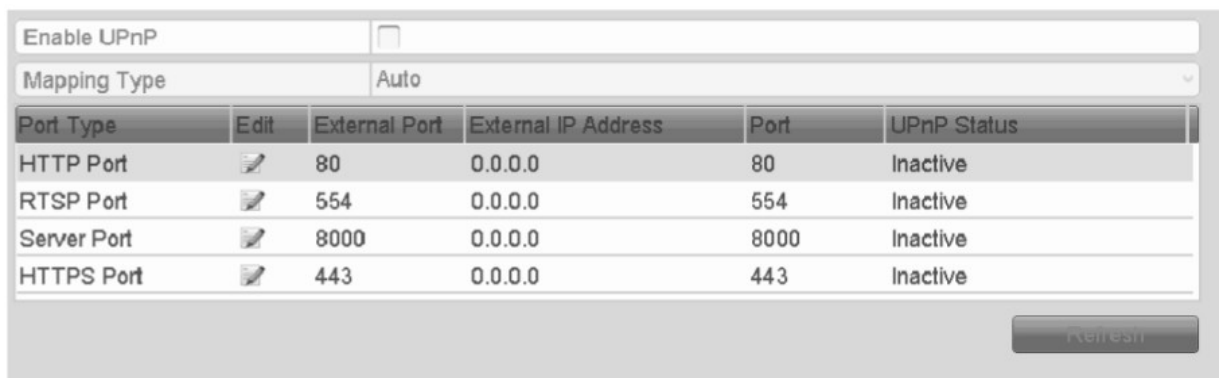
Universal Plug and Play (UPnP™) can permit the device to seamlessly discover the presence of other network devices on the network and to establish functional network services for data sharing, communications, etc. You can use the UPnP™ function to enable the fast connection of the device to the WAN via a router without port mapping.

Before you start:





If you want to enable the UPnP™ function of the device, you must enable the UPnP™ function of the router to which your device is connected. When the network working mode of the device is set as multi-address, the Default Route of the device should be in the same network segment as that of the LAN IP address of the router.

Steps:

1. Enter the Network Settings interface: Menu> Configuration> Network
2. Select the "NAT" tab to enter the port mapping interface.



The screenshot shows a web interface for NAT port mapping. At the top, there is a checkbox for "Enable UPnP" which is currently unchecked. Below it is a dropdown menu for "Mapping Type" set to "Auto". The main part of the interface is a table with the following columns: "Port Type", "Edit", "External Port", "External IP Address", "Port", and "UPnP Status".

Port Type	Edit	External Port	External IP Address	Port	UPnP Status
HTTP Port		80	0.0.0.0	80	Inactive
RTSP Port		554	0.0.0.0	554	Inactive
Server Port		8000	0.0.0.0	8000	Inactive
HTTPS Port		443	0.0.0.0	443	Inactive

At the bottom right of the table area, there is a "Refresh" button.

3. Check the checkbox next to "Enable UPnP" to enable UPnP™.
4. Select the "Mapping Type" from "Manual" or "Auto" in the drop-down list.

OPTION 1: Auto

If you select Auto, the Port Mapping items are read-only, and the external ports are going to be set by the router automatically.

Steps:

- 1) Select "Auto" in the drop-down list of Mapping Type.
- 2) Click the "Apply" button to save the settings.
- 3) You can click the "Refresh" button to get the latest status of the port mapping.

Port Type	Edit	External ...	Mapping IP Address	Port	Status
Server Port		43728	172.6.23.114	8000	Active
HTTP Port		31397	172.6.23.114	80	Active
RTSP Port		59826	172.6.23.114	554	Active
HTTPS Port		31231	172.6.23.114	443	Active

OPTION 2: Manual

If you select "Manual" as the mapping type, you can edit the external port on your demand by clicking on the "[pencil on a written sheet]" symbol to activate the External Port Settings dialogue box.

Steps:

- 1) Select "Manual" in the drop-down list of Mapping Type.
- 2) Click on the "[pencil on a written sheet]" symbol to activate the External Port Settings dialogue box. Configure the external port No. For server port, http port, RTSP port and https port respectively.

NOTE:

- You can use the default port No., or change it according to your actual requirements.
- The External Port indicates the port No. For port mapping in the router.
- The value of the RTSP port No. Should be 554 or between 1024 and 65535, while the value of the other ports should be between 1 and 65535 and the values must be different from each other. If multiple devices are configured for the UPnP™ settings under the same router, the value of the port No. For each device should be unique.

External Port Settings	
Port Type	Server Port
External Port	8001

3) Click the "Apply" button to save the settings.

4) You can click the "Refresh" button to get the latest status of the port mapping.

Enable UPnP		<input checked="" type="checkbox"/>			
Mapping Type		Manual			
Port Type	Edit	External ...	Mapping IP Address	Port	Status
Server Port		8001	172.6.23.114	8000	Active
HTTP Port		81	172.6.23.114	80	Active
RTSP Port		2554	172.6.23.114	554	Active
HTTPS Port		443	172.6.23.114	443	Active

Refresh

Manual Mapping:

If your router does not support the UPnP function, perform the following steps to map the port manually in an easy way.

Before you start:

Make sure the router supports the configuration of the internal port and the external port in the interface of Forwarding.

Steps:

1. Enter the Network Settings interface: Menu> Configuration> Network
2. Select the "NAT" tab to enter the port mapping interface.
3. Leave the "Enable UPnP" checkbox unchecked.
4. Click on the "[pencil on a written sheet]" symbol to activate the External Port Settings dialogue box. Configure the external port No. For server port, http port, RTSP port and https port respectively.

NOTE: The value of the RTSP port No. Should be 554 or between 1024 and 65535, while the value of the other ports should be between 1 and 65535 and the values must be different from each other. If multiple devices are configured for the UPnP™ settings under the same router, the value of the port No. For each device should be unique.

Port Type	Server Port
External Port	8000

OK Cancel

5. Click "OK" to save the setting for the current port and to return to the upper-level menu.

6. Click the "Apply" button to save the settings.

7. Enter the virtual server setting page of router; fill in the blank of the Internal Source Port with the internal port value, the blank of External Source Port with the external port value, and other required contents.

NOTE: Each item should be corresponding with the device port, including server port, http port, RTSP port and https port.

Delete	External Source Port	Protocol	Internal Source IP	Internal Source Port	Application
<input type="checkbox"/>	81	TCP	192.168.251.101	80	HTTP

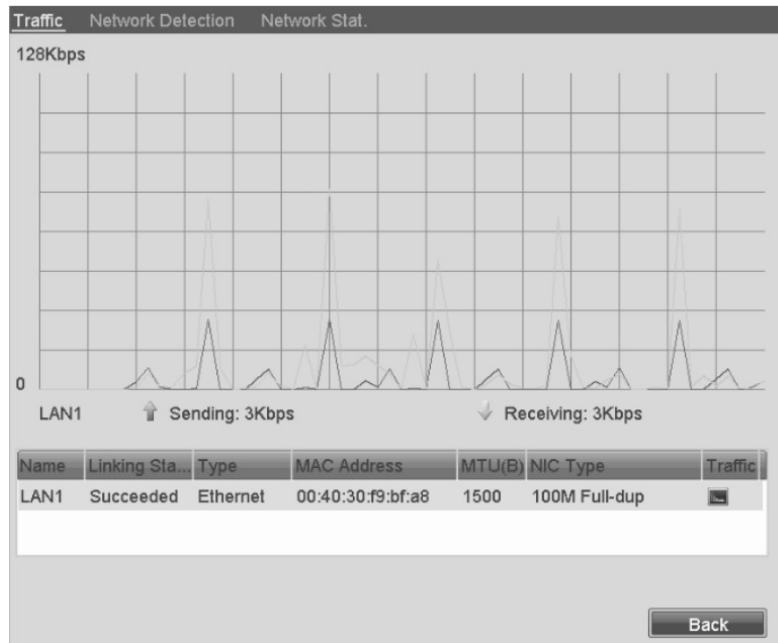
NOTE: The above virtual server setting interface is for reference only, it may be different due to different router manufacturers. Please contact the manufacturer of the router if you have any problems with setting the virtual server.

12.3. Checking the Network Traffic

You can check the network traffic to obtain real-time information of the NVR such as linking status, MTU, sending/receiving rate, etc.

Steps:

1. Enter the Network Traffic interface: Menu > Maintenance > Net Detect



2. You can view the sending rate and receiving rate information on the interface. The traffic data is going to be refreshed every second.

12.4. Configuring the Network Detection

You can obtain the network connecting status of the NVR through the network detection function, including network delay, packet loss, etc.

12.4.1. Testing the Network Delay and Packet Loss

Steps:

1. Enter the Network Traffic interface: Menu > Maintenance > Net Detect
2. Click the "Network Detection" tab to enter the Network Detection menu.

The screenshot shows the 'Network Detection' interface. At the top, there are three tabs: 'Traffic', 'Network Detection', and 'Network Stat.'. Below the tabs is a section titled 'Network Delay, Packet Loss Test'. It contains two input fields: 'Select NIC' with 'LAN1' selected, and 'Destination Address'. To the right of these fields is a 'Test' button. Below this section is another section titled 'Network Packet Export'. It contains one input field: 'Device Name'. To the right of this field are 'Refresh' and 'Export' buttons. At the bottom of the interface, there is a table with the following columns: Name, Linking Sta..., Type, MAC Address, MTU(B), NIC Type, and Traffic. The table contains one row for 'LAN1' with the following values: Succeeded, Ethernet, 00:40:30:f9:bf:a8, 1500, 100M Full-dup, and a small icon.

3. Enter the destination address in the text field of "Destination Address".
4. Click the "Test" button to start testing network delay and packet loss. The testing result pops up on the window. If the testing failed, the error message box will pop up as well.



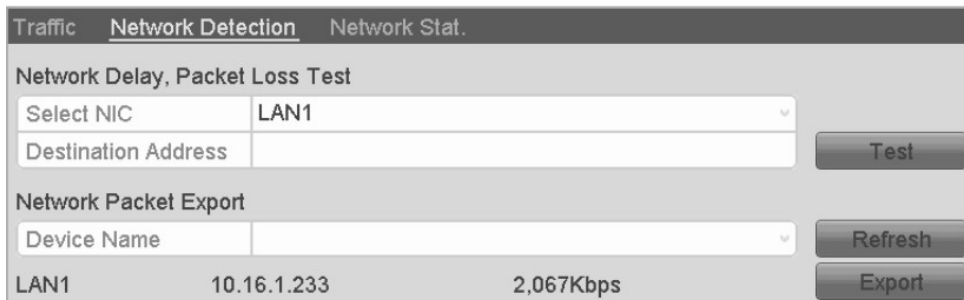
12.4.2. Exporting the Network Packet

By connecting the NVR to the network, the captured network data packet can be exported to a USB-flash disk, eSATA and USB - DVD-R/W.

Steps:

1. Enter the Network Traffic interface: Menu> Maintenance> Net Detect
2. Click the "Network Detection" tab to enter the Network Detection interface.
3. Select the backup device from the dropdown list of "Device Name".

NOTE: Click the "Refresh" button if the connected local backup device cannot be displayed. When it fails to detect the backup device, please check whether it is compatible with the NVR. You can format the backup device if the format is incorrect.



4. Click the "Export" button to start exporting.
5. After the exporting is complete, click "OK" to finish the packet export, as shown below.



NOTE: Up to 1M of data can be exported each time.

12.4.3. Checking the Network Status

You can also check the network status and quickly set the network parameters in this interface.

Steps:

Click the "Status" button on the lower-right corner of the page.

The screenshot shows a web interface with three tabs: "Traffic", "Network Detection", and "Network Stat.". Under "Network Detection", there are two sections. The first is "Network Delay, Packet Loss Test" with a "Select NIC" dropdown set to "LAN1" and a "Destination Address" field set to "10.16.1.108". A "Test" button is to the right. The second section is "Network Packet Export" with a "Device Name" dropdown set to "LAN1" and a "Refresh" button. Below this is a table showing network statistics:

LAN1	10.16.1.233	2,240Kbps
------	-------------	-----------

At the bottom right of the interface are three buttons: "Status", "Network", and "Back".

If the network is normal, the following message box will pop up.



If the message box pops up with other information instead of this one, you can click on the "Network" button to show the quick setting interface of the network parameters.

12.4.4. Checking the Network Statistics

You can check here the network status to obtain the real-time information of NVR.

Steps:

1. Enter the Network Detection interface: Menu> Maintenance> Net Detect
2. Choose the "Network Stat." tab.

Type	Bandwidth
IP Camera	7,168Kbps
Remote Live View	2,048Kbps
Remote Playback	0bps
Net Receive Idle	13Mbps
Net Send Idle	38Mbps

At the bottom right of the table is a "Refresh" button.

3. Check the bandwidth of the IP Camera, the bandwidth of the Remote Live View, bandwidth of Remote Playback, bandwidth of Net Receive Idle and bandwidth of Net Send Idle.
4. You can click "Refresh" to get the newest status.

13. HDD Management

13.1. Initialising HDDs

A newly installed hard disk drive (HDD) must be initialised before it can be used with your NVR.

NOTE: A message box pops up when the NVR starts up if any uninitialised HDD exists.



Click the "Yes" button to initialise it immediately or you can perform the following steps to initialise the HDD.

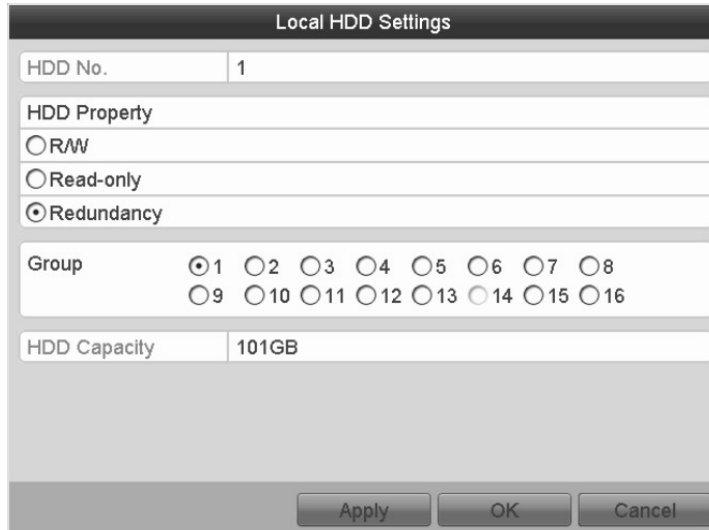
Steps:

1. Enter the HDD Information interface: Menu> HDD> General
2. Select the HDD to be initialised.
3. Click the "Init" button.

<input type="checkbox"/>	Label	Capacity	Status	Property	Type	Free Space	Group	Edit	Delete
<input checked="" type="checkbox"/>	2	465.76GB	Uninitialized	R/W	Local	0MB	1		

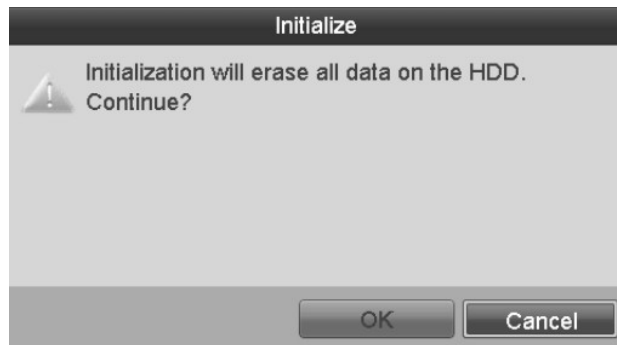
2. Select the “HDD” and click on the “[pen on a written sheet]” button to enter the Local HDD Settings interface.

1) Set the HDD property to “Redundancy”.



2. Select the “HDD” and click on the “[pen on a written sheet]” button to enter the Local HDD Settings interface.

1) Set the HDD property to “Redundancy”.



4. Select the “OK” button to start the initialisation.



5. After the HDD has been initialised, the status of the HDD will change from “Uninitialized” to “Normal”.

NOTE: Initialising the HDD will erase all data on it.



13.2. Managing the Network HDD

You can add the allocated NAS or disk of IP SAN to the NVR, and use it as a network HDD.

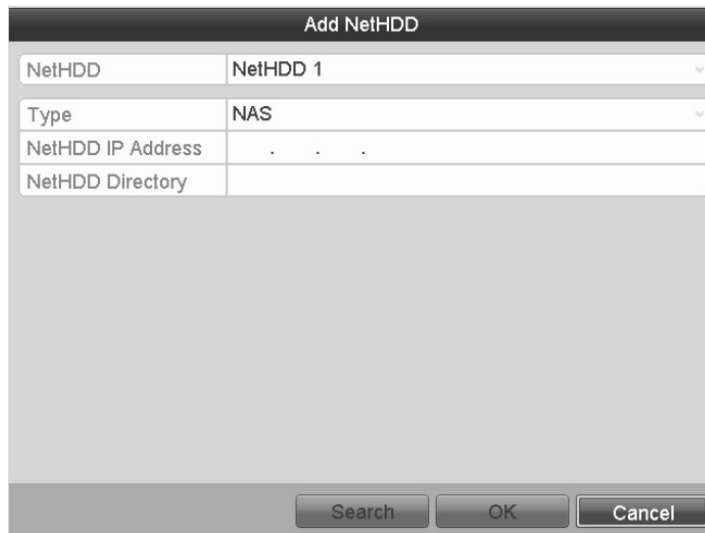
Steps:

1. Enter the HDD Information interface: Menu> HDD> General



Label	Capacity	Status	Property	Type	Free Space	Group	Edit	Delete
2	465.76GB	Normal	R/W	Local	465GB	1		

2. Click the “Add” button to enter the Add NetHDD interface, as shown below.



Add NetHDD	
NetHDD	NetHDD 1
Type	NAS
NetHDD IP Address	. . .
NetHDD Directory	

Search OK Cancel

3. Add the allocated “NetHDD”.

4. Select the type from “NAS” or “IP SAN2”.

5. Configure the NAS or IP SAN settings.

- Add an NAS disk:

1) Enter the NetHDD IP address in the text field.

2) Click the “Search” button to search the available NAS disks.

3) Select the NAS disk from the list shown below.

Or you can just manually enter the directory in the text field of the NetHDD Directory.

4) Click the “OK” button to add the configured NAS disk.

NOTE: Up to 8 NAS disks can be added.



Add NetHDD	
NetHDD	NetHDD 1
Type	NAS
NetHDD IP Address	172.6.24.213
NetHDD Directory	/dvr/dvr_3

No.	Directory
1	/dvr/dvr_3
2	/dvr/Dvr_test
3	/dvr/test
4	/dvr/dvr_2
5	/dvr/dvr_1

Search OK Cancel

- Add an IP SAN:

- 1) Enter the NetHDD IP address in the text field.
- 2) Click the "Search" button to search the available IP SAN disks.
- 3) Select the IP SAN disk from the list shown below.
- 4) Click the "OK" button to add the selected IP SAN disk.

NOTE: Only 1 IP SAN disk can be added.

Add NetHDD	
NetHDD	NetHDD 1
Type	IP SAN
NetHDD IP Address	172.16.24.213
NetHDD Directory	iqn.2004-05.storos.t-1
No.	Directory
1	iqn.2004-05.storos.t-1

6. After having successfully added the NAS or IP SAN disk, return to the HDD Information menu. The added NetHDD will be displayed in the list.

NOTE: If the added NetHDD is uninitialised, please select it and click the "Init" button for initialisation.

Label	Capacity	Status	Property	Type	Free Space	Gro...	Edit	Del...
<input type="checkbox"/> 6	931.51GB	Normal	R/W	Local	912GB	1		
<input type="checkbox"/> 17	20,448MB	Normal	R/W	NAS	19,456MB	1		
<input type="checkbox"/> 18	488.28GB	Normal	R/W	IP SAN	488GB	1		

13.3. Managing a HDD Group

13.3.1. Setting up HDD Groups

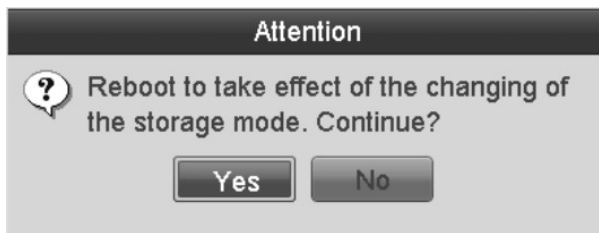
Multiple HDDs can be managed in groups. The Video from specified channels can be recorded onto a particular HDD group through the HDD settings.

Steps:

1. Enter the Storage Mode interface: Menu> HDD> Advanced
2. Set the "Mode" to "Group", as shown below.

Storage Mode	
Mode	Group
Record on HDD Group	1
<input checked="" type="checkbox"/> IP Camera	<input checked="" type="checkbox"/> D1 <input checked="" type="checkbox"/> D2 <input checked="" type="checkbox"/> D3 <input checked="" type="checkbox"/> D4

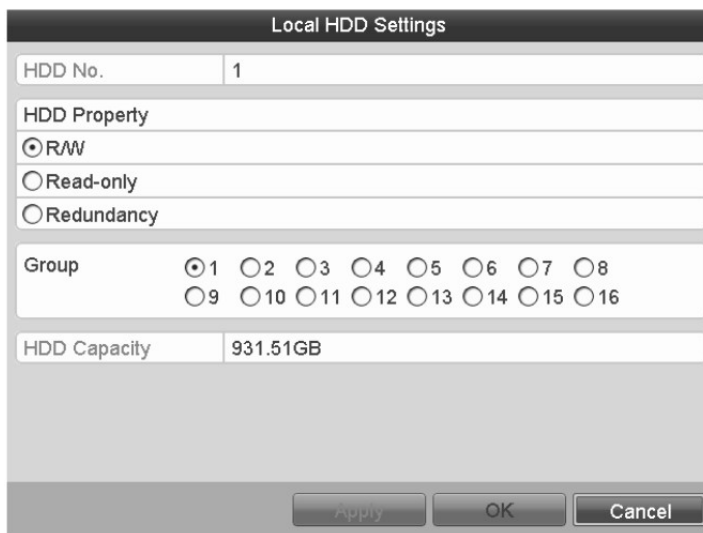
3. When you click the “Apply” button, the following Attention Box will pop up.



4. Click the “Yes” button to reboot the device to activate the changes.

5. After rebooting the device, enter the HDD Information interface: Menu> HDD> General

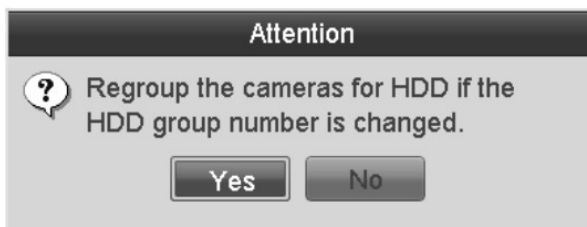
6. Select a HDD from the list and click on the “[pencil on a written sheet]” icon to enter the Local HDD Settings interface, as shown below.



7. Select the Group number for the current HDD.

NOTE: The default group No. for each HDD is 1.

8. Click the “OK” button to confirm the settings.



9. In the pop-up Attention Box, click the “Yes” button to finish the settings.

13.3.2. Setting a HDD Property

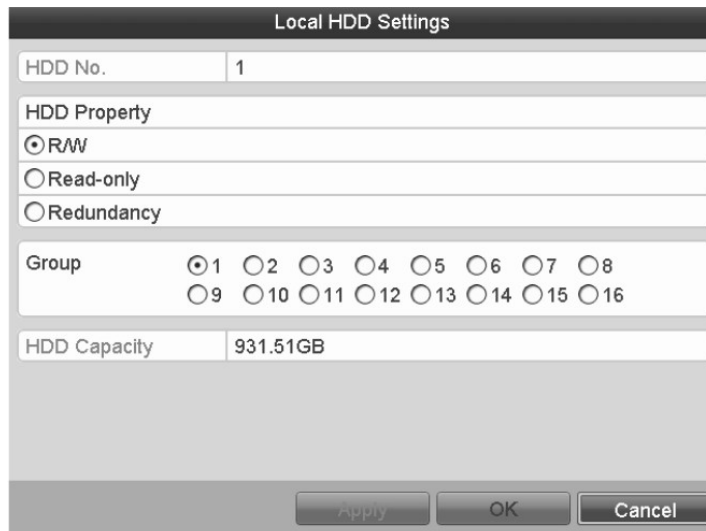
The HDD property can be set to redundancy, read-only or read/write (R/W). Before setting the HDD property, please set the "Storage Mode" to "Group" (refer to Steps 1-4 of the Chapter "Setting up HDD Groups").

An HDD can be set to read-only to prevent important recorded files from being overwritten when the HDD becomes full in overwrite recording mode.

When the HDD property is set to redundancy, the video can be recorded both onto the redundancy HDD and the R/W HDD simultaneously so as to ensure high security and reliability of video data.

Steps:

1. Enter the HDD Information interface: Menu> HDD> General
2. Select a HDD from the list and click the on the "[pencil on a written sheet]" icon to enter the Local HDD Settings interface, as shown below.



The image shows the "Local HDD Settings" dialog box. It contains the following fields and options:

- HDD No.: 1
- HDD Property:
 - R/W
 - Read-only
 - Redundancy
- Group:
 - 1
 - 2
 - 3
 - 4
 - 5
 - 6
 - 7
 - 8
 - 9
 - 10
 - 11
 - 12
 - 13
 - 14
 - 15
 - 16
- HDD Capacity: 931.51GB

Buttons: Apply, OK, Cancel

3. Set the HDD property to R/W, Read-only or Redundancy.
4. Click the "OK" button to save the settings and exit the interface.
5. In the HDD Information menu, the HDD property will be displayed in the list.

NOTE: At least 2 hard disks must be installed on your NVR when you want to set a HDD to "Redundancy", and only one HDD can be set to "R/W".

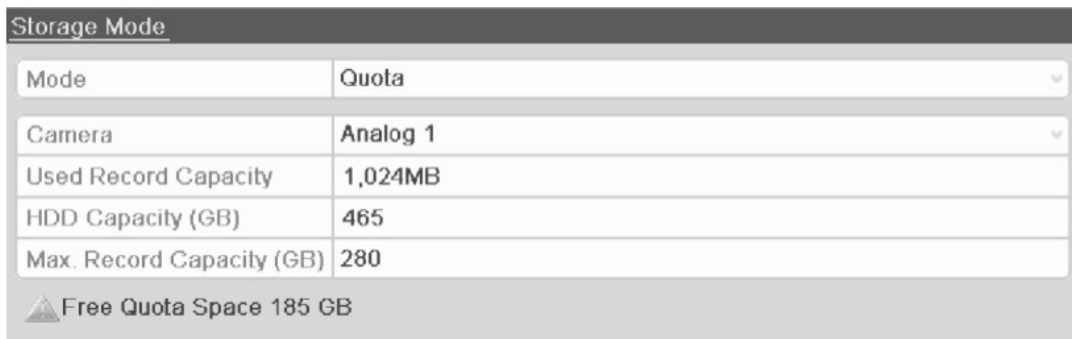
13.4. Configuring the Quota Mode

Each camera can be configured with the allocated quota for the storage of the recorded files.

Steps:

1. Enter the Storage Mode interface: Menu> HDD> Advanced
2. Set the "Mode" to "Quota", as shown below.

NOTE: The NVR must be rebooted to enable the changes to take effect.

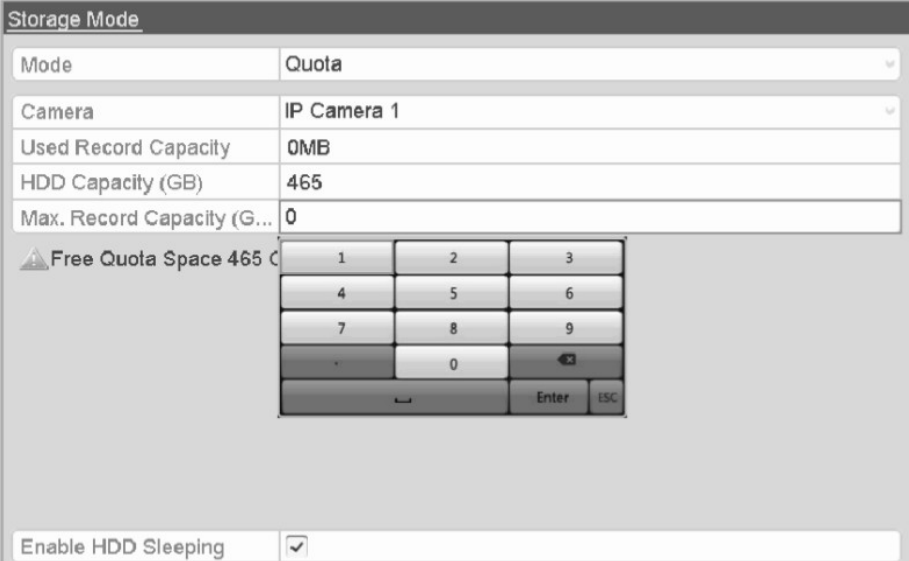


The image shows the "Storage Mode" interface with the following settings:

Mode	Quota
Camera	Analog 1
Used Record Capacity	1,024MB
HDD Capacity (GB)	465
Max. Record Capacity (GB)	280

Free Quota Space 185 GB

3. Select a camera for which you want to configure the quota.
4. Enter the storage capacity in the text fields of “Max. Record Capacity (GB)”, as shown below.




The image shows a 'Storage Mode' configuration window. It contains a table with the following data:

Mode	Quota
Camera	IP Camera 1
Used Record Capacity	0MB
HDD Capacity (GB)	465
Max. Record Capacity (G...	0

Below the table, there is a warning icon and the text 'Free Quota Space 465 C'. To the right of this text is a numeric keypad with buttons for digits 1-9, 0, a left arrow, and 'Enter' and 'ESC' keys. At the bottom of the window, there is a checkbox labeled 'Enable HDD Sleeping' which is checked.

5. You can copy the quota settings of the current camera to other cameras if required. Click the “Copy” button to enter the “Copy Camera” menu, as shown below.



The image shows a 'Copy to' dialog box. It has a title bar 'Copy to' and a list of checkboxes: IP Camera, D1, D2, D3, and D4. At the bottom of the dialog box, there are two buttons: 'OK' and 'Cancel'.

6. Select the camera(s) to be configured with the same quota settings. You can also click the checkbox of IP Camera to select all cameras.
7. Click the “OK” button to finish the Copy settings and go back to the Storage Mode interface.
8. Click the “Apply” button to apply the settings.

NOTE: If the quota capacity is set to 0, then all cameras will use the total capacity of the HDD for recording.

13.5. Checking the HDD Status

You may check the status of the installed HDDs on the NVR so as to take immediate check and maintenance in case of HDD failure.

Checking the HDD Status on the HDD Information Interface:

Steps:

1. Enter the HDD Information interface: Menu> HDD> General
2. Check the status of each HDD which is displayed on the list, as shown below.



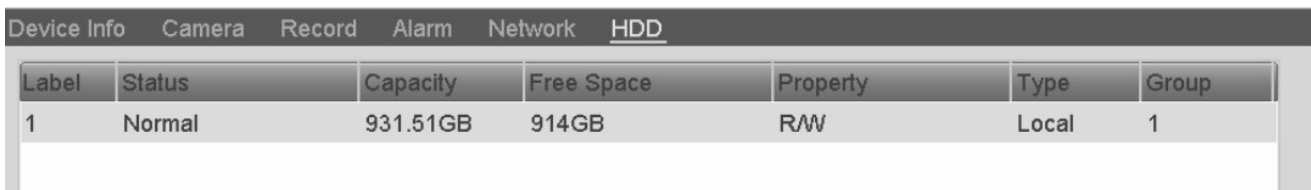
Label	Capacity	Status	Property	Type	Free Space	Gro...	Edit	Del...
1	931.51GB	Normal	R/W	Local	931GB	1		

NOTE: If the status of the HDD is “Normal” or “Sleeping”, it works normally. If the status is “Uninitialized” or “Abnormal”, please initialise the HDD before use. And if the HDD initialisation failed, please replace the HDD with a new one.

Checking the HDD Status on the System Information Interface:

Steps:

1. Enter the System Information interface:
Menu> Maintenance> System Info
2. Click the “HDD” tab to view the status of each HDD displayed on the list, as shown in below.



Label	Status	Capacity	Free Space	Property	Type	Group
1	Normal	931.51GB	914GB	R/W	Local	1

13.6. HDD Detection

The device provides the HDD detection function such as the adopting of the S.M.A.R.T. and the Bad Sector Detection technique. The S.M.A.R.T. (Self-Monitoring, Analysis and Reporting Technology) is a monitoring system for the HDD to detect and report on various indicators of reliability in the hope of anticipating failures.

S.M.A.R.T. Settings:

Steps:

1. Enter the S.M.A.R.T Settings interface: Menu> Maintenance> HDD Detect
2. Select the HDD to view its S.M.A.R.T information list, as shown below.

The screenshot shows the 'S.M.A.R.T. Settings' window with a 'Bad Sector Detection' sub-tab. At the top, there is a checkbox labeled 'Continue to use this disk when self-evaluation is failed.' Below this, several parameters are listed in a table-like format:

HDD	1
Self-test Status	Not tested
Self-test Type	Short Test
S.M.A.R.T.	
Temperature (°C)	38
Power On (days)	267
Self-evaluation	Pass
All-evaluation	Bad sectors

Below these settings is the 'S.M.A.R.T. Information' section, which contains a table with the following data:

ID	Attribute Name	Status	Flags	Threshold	Value	Worst	Raw Value
0x1	Raw Read Error Rate	OK	2f	51	200	200	418
0x3	Spin Up Time	OK	27	21	150	107	5458
0x4	Start/Stop Count	OK	32	0	100	100	737
0x5	Reallocated Sector Count	OK	33	140	200	200	0
0x7	Seek Error Rate	OK	2e	0	200	200	0
0x9	Power-on Hours Count	OK	32	0	92	92	6429
0xa	Spin Up Retry Count	OK	32	0	100	100	0

The related information of the S.M.A.R.T. is shown on the interface. You can choose "Self-test Type" from "Short Test", "Expanded Test" or the "Conveyance Test". Click the "Start" button to start the S.M.A.R.T. HDD self-evaluation.

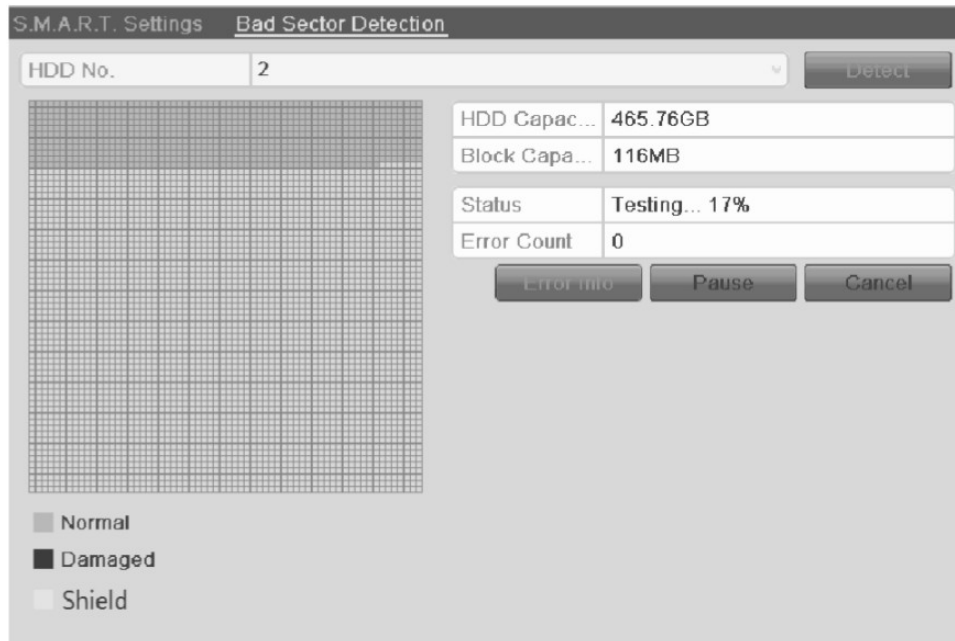


NOTE: If you want to use the HDD even when S.M.A.R.T. checking failed, you can check the checkbox of the "Continue to use the disk when self-evaluation failed" item.

Bad Sector Detection:

Steps:

1. Click the "Bad Sector Detection" tab.
2. Select the "HDD No." in the dropdown list you want to configure, and choose "All Detection" or "Key Area Detection" as detection type.
3. Click the "Detect" button to start the detection.



And you can click on the "Error info" button to see the detailed damage information. And you can also pause/resume or cancel the detection.

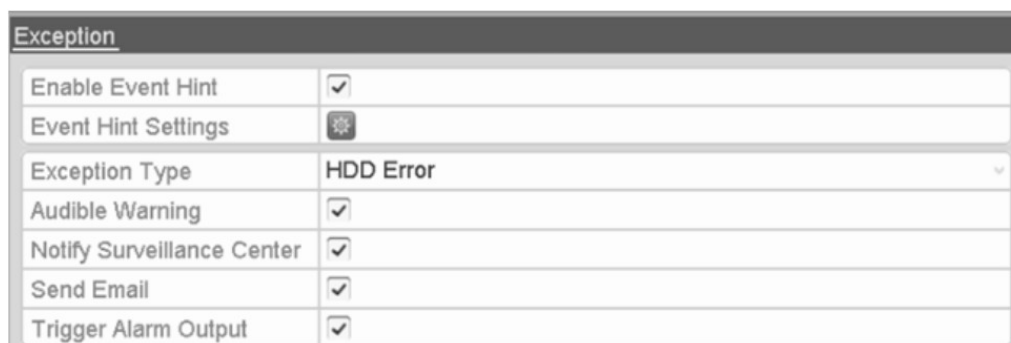
13.7. Configuring HDD Error Alarms

You can configure the HDD error alarms when the HDD status is "Uninitialized" or "Abnormal".

Steps:

1. Enter the Exception interface: Menu> Configuration> Exceptions
2. Set the Exception Type to "HDD Error" in the dropdown list.
3. Click the checkbox(s) below to select the HDD error alarm type(s), as shown below.

The alarm type can be set to: Audible Warning, Notify Surveillance Center, Send Email and Trigger Alarm Output. Please refer to Chapter "Setting Alarm Response Actions".



4. When the "Trigger Alarm Output" is selected, you can also select the alarm output to be triggered from the list below.
5. Click the "Apply" button to save the settings.

14. Camera Settings

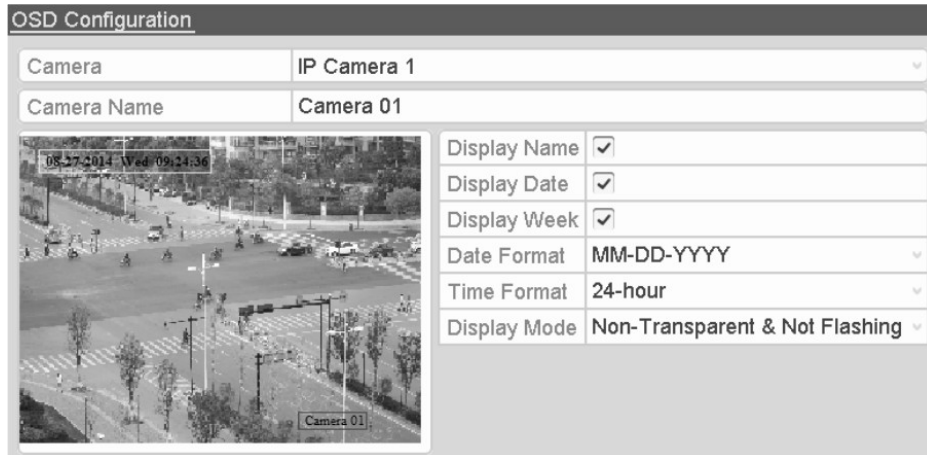
14.1. Configuring the OSD Settings

You can configure the OSD (On-screen Display) settings for the camera, including date /time, camera name, etc.

Please note: The available functions differ from protocol to protocol. Not all protocols support all functions described below. If the function is not supported, you will need to edit it in the OSD of the camera.

Steps:

1. Enter the OSD Configuration interface: Menu > Camera > OSD
2. Select the camera to configure the OSD settings for.
3. Edit the "Camera Name" in the text field.
4. Configure the Display Name, Display Date and Display Week by clicking the checkboxes.
5. Select the Date Format, Time Format and Display Mode.



OSD Configuration	
Camera	IP Camera 1
Camera Name	Camera 01
Display Name	<input checked="" type="checkbox"/>
Display Date	<input checked="" type="checkbox"/>
Display Week	<input checked="" type="checkbox"/>
Date Format	MM-DD-YYYY
Time Format	24-hour
Display Mode	Non-Transparent & Not Flashing

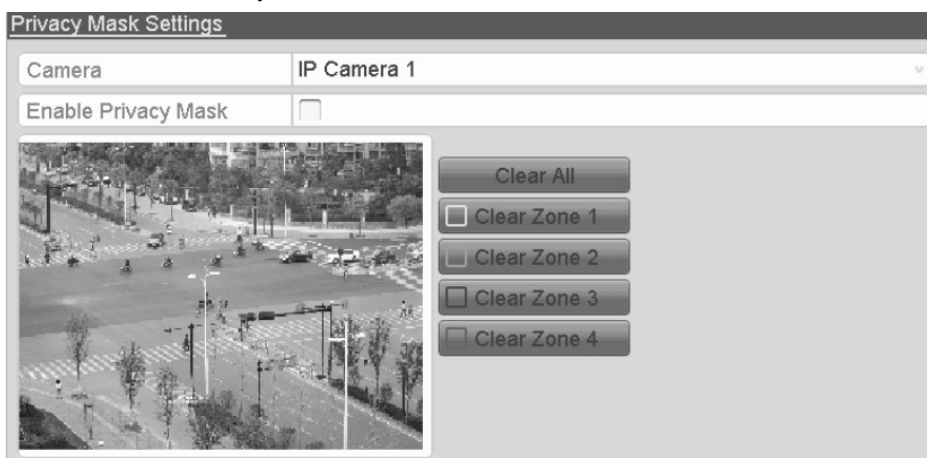
6. You can use the mouse to click and drag the text frame on the preview window to adjust the OSD position.
7. Click the "Apply" button to apply the settings.

14.2. Configuring a Privacy Mask

You are allowed to configure the four-sided privacy mask zones that cannot be viewed by the operator. The privacy mask can prevent certain surveillance areas to be viewed or recorded.

Steps:

1. Enter the Privacy Mask Settings interface: Menu> Camera> Privacy Mask
2. Select the camera to set the privacy mask for.
3. Click the checkbox of "Enable Privacy Mask" to enable this feature.



Privacy Mask Settings	
Camera	IP Camera 1
Enable Privacy Mask	<input type="checkbox"/>
Clear All	
Clear Zone 1	
Clear Zone 2	
Clear Zone 3	
Clear Zone 4	

4. Use the mouse to draw a zone in the window. The zones will be marked in different frame colours.

NOTE: Up to 4 privacy masks zones can be configured and the size of each area can be adjusted.

5. The configured privacy mask zones on the window can be cleared by clicking the corresponding “Clear Zone 1(-4)” icons on the right side of the window, or click “Clear All” to clear all zones.

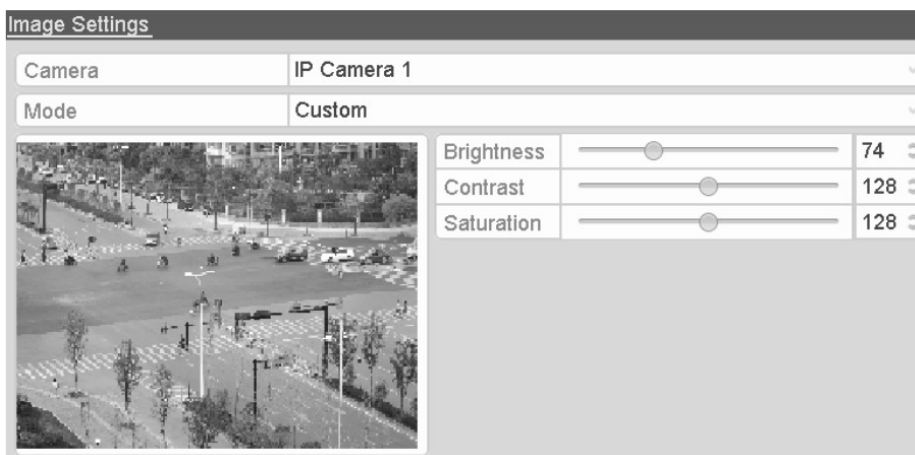


6. Click the “Apply” button to save the settings.

14.3. Configuring Video Parameters

Steps:

1. Enter the Image Settings interface: Menu> Camera> Image



2. Select the camera to set the image parameters.

3. You can click on the arrow to change the value of each parameter.

4. Click the “Apply” button to save the settings.

15. NVR Management

15.1. Viewing the System Information

Steps:

1. Enter the System Information interface: Menu> Maintenance> System Info
2. You can click the Device Info, Camera, Record, Alarm, Network and HDD tabs to view the system information of the device.

Device Info		Camera	Record	Alarm	Network	HDD
Device Name	Network Video Recorder					
Model						
Serial No.						
Firmware Version						
Encoding Version						
Verification Code	ABCDEF					

15.2. Searching & Exporting Log Files

The operation, alarm, exception and information of the NVR/DVR can be stored in log files, which can be viewed and exported at any time.

Steps:

1. Enter the Log Search interface: Menu> Maintenance> Log Information

Log Search		Log Export	
Start Time	09-22-2014	00:00:00	
End Time	09-22-2014	23:59:59	
Major Type	All		
<input checked="" type="checkbox"/> Minor Type			
<input checked="" type="checkbox"/> Alarm Input			
<input checked="" type="checkbox"/> Alarm Output			
<input checked="" type="checkbox"/> Motion Detection Started			
<input checked="" type="checkbox"/> Motion Detection Stopped			
<input checked="" type="checkbox"/> Video Tampering Detection Started			
<input checked="" type="checkbox"/> Video Tampering Detection Stopped			
<input checked="" type="checkbox"/> Line Crossing Detection Alarm Started			
<input checked="" type="checkbox"/> Line Crossing Detection Alarm Stopped			
<input checked="" type="checkbox"/> Intrusion Detection Alarm Started			
<input checked="" type="checkbox"/> Intrusion Detection Alarm Stopped			
<input checked="" type="checkbox"/> Audio Input Exception Alarm Started			
<input checked="" type="checkbox"/> Audio Input Exception Alarm Stopped			
<input checked="" type="checkbox"/> Sudden Change of Sound Intensity Alarm Started			

2. Set the log search conditions to refine your search, including the Start Time, End Time, Major Type and Minor Type.
3. Click the "Search" button to start to search the log files.
4. The matched log files will be displayed on the list shown below.

Search Result						
No.	Major Type	Time	Minor Type	Parameter	Play	Details
1	Operation	09-22-2014 15:03:43	Power On	N/A	⏮	✓
2	Information	09-22-2014 15:03:43	Local HDD Infor...	N/A	⏮	✓
3	Operation	09-22-2014 15:03:46	Local Operation:...	N/A	⏮	✓
4	Exception	09-22-2014 15:03:49	IP Conflicted	N/A	⏮	✓
5	Exception	09-22-2014 15:04:06	IP Camera Disco...	N/A	⏮	✓
6	Exception	09-22-2014 15:04:06	IP Camera Disco...	N/A	⏮	✓
7	Exception	09-22-2014 15:04:06	IP Camera Disco...	N/A	⏮	✓
8	Exception	09-22-2014 15:04:06	IP Camera Disco...	N/A	⏮	✓
9	Exception	09-22-2014 15:04:06	IP Camera Disco...	N/A	⏮	✓
10	Exception	09-22-2014 15:04:06	IP Camera Disco...	N/A	⏮	✓
11	Exception	09-22-2014 15:04:06	IP Camera Disco...	N/A	⏮	✓
12	Exception	09-22-2014 15:04:06	IP Camera Disco...	N/A	⏮	✓
13	Exception	09-22-2014 15:04:06	IP Camera Disco...	N/A	⏮	✓
14	Information	09-22-2014 15:04:11	HDD S.M.A.R.T.	N/A	⏮	✓

Total: 24 P: 1/1

NOTE: Up to 2000 log files can be displayed each time.

5. You can click the "(tick)" button of each log or double click it to view its detailed information, as shown below. And you can also click the ">" button to view the related video files if available.

Log Information	
Time	24-03-2000 14:40:57
Type	Information--Start Recording
Local User	N/A
Host IP Address	N/A
Parameter Type	N/A
Camera No.	D2
Description:	
Camera: D2 starts recording. Record status: Record enabled: Yes Event parameters: Enabled Record type: Motion Motion detected on camera: D2 Alarm detected on camera: None	
<input type="button" value="Previous"/> <input type="button" value="Next"/> <input type="button" value="OK"/>	

6. If you want to export the log files, click the "Export" button to enter the Export menu, as shown below.

Export				
Device Name	USB1-1			<input type="button" value="Refresh"/>
Name	Size	Type	Edit Date	Delete Play
Free Space	7.664MB			
<input type="button" value="New Folder"/> <input type="button" value="Format"/> <input type="button" value="Export"/> <input type="button" value="Cancel"/>				

-
7. Select the backup device from the dropdown list under "Device Name".
 8. Click the "Export" to export the log files to the selected backup device.

You can click the "New Folder" button to create a new folder in the backup device, or click the "Format" button to format the backup device before the log export.

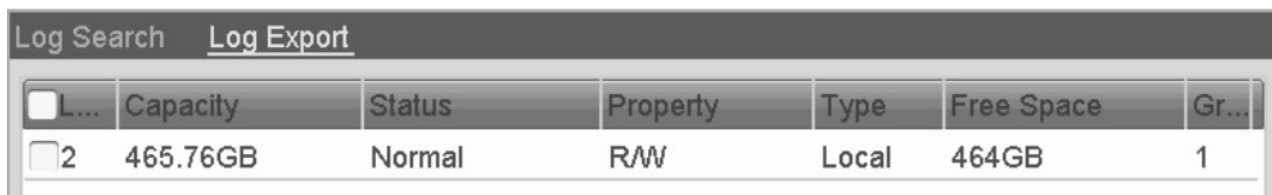
NOTE:

- Please connect the backup device to the NVR before operating the log export.
- The log files exported to the backup device are named by the exporting time, e.g., 20110514124841logBack.txt.

To export all the log files:

Steps:

1. Enter the Log Information interface: Menu> Maintenance> Log Information> Log Export
2. Click the "Log Export" tab.



<input type="checkbox"/> L...	Capacity	Status	Property	Type	Free Space	Gr...
<input type="checkbox"/> 2	465.76GB	Normal	R/W	Local	464GB	1

3. You can check the checkbox of the HDD.
4. Click the "Export" button to export all the log files stored in the HDD.

15.3. Import/Export of Camera Information

The information of the added IP camera can be generated into an excel file and exported to the local device for backup, including the IP address, manage port, password of admin, etc. And the exported file can be edited on your PC, like adding or deleting the content, and copying the setting to other devices by importing the excel file to them.

Steps:

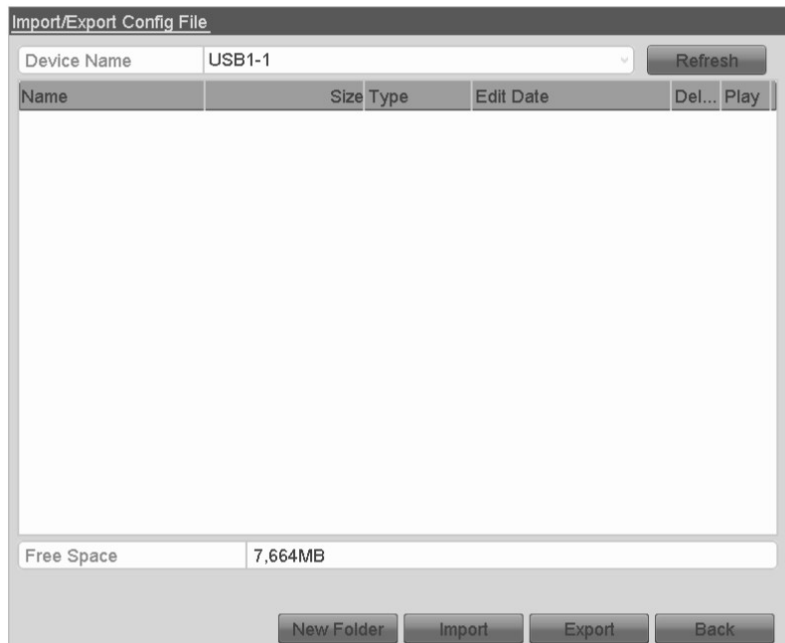
1. Enter the camera management interface: Menu> Camera> IP Camera Import/Export
2. If you click the "IP Camera Import/Export" tab, the content of detected plugged external device will appear.
3. Click the "Export" button to export the configuration files to the selected local backup device.
4. To import a configuration file, select the file from the selected backup device and click the "Import" button. After the importing process is completed, you must reboot the NVR.

15.4. Import/Export of Configuration Files

The configuration files of the NVR can be exported to a local device for backup; and the configuration files of one NVR can be imported to multiple NVR devices if they are to be configured with the same parameters.

Steps:

1. Enter the Import/Export Configuration File interface: Menu> Maintenance> Import/Export



2. Click the “Export” button to export the configuration files to the selected local backup device.
3. To import a configuration file, select the file from the selected backup device and click the “Import” button. After the import process is completed, you must reboot the NVR.

NOTE: After having finished the import of configuration files, the device will reboot automatically.

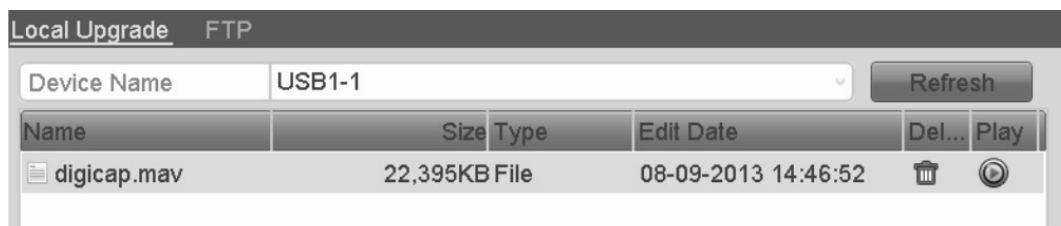
15.5. Upgrading the System

The firmware on your NVR can be upgraded by a local backup device or remote FTP server.

15.5.1. Upgrading by a Local Backup Device

Steps:

1. Connect your NVR with a local backup device where the update firmware file is located.
2. Enter the Upgrade interface: Menu> Maintenance> Upgrade
3. Click the “Local Upgrade” tab to enter the local upgrade menu, as shown below.



4. Select the update file from the backup device.
5. Click the “Upgrade” button to start upgrading.
6. After the upgrading is complete, reboot the NVR to activate the new firmware.

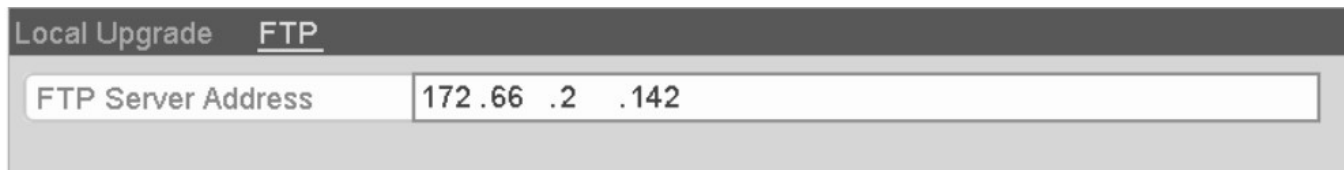
15.5.2. Upgrading by FTP

Ensure that the network connection of the PC (running FTP server) and the device is valid and correct. Run the FTP server on the PC and copy the firmware into the corresponding directory of your PC.

NOTE: Refer to the user manual of the FTP server to set the FTP server on your PC and put the firmware file into the directory as required.

Steps:

1. Enter the Upgrade interface: Menu> Maintenance> Upgrade
2. Click the "FTP" tab to enter the local upgrade interface, as shown below.



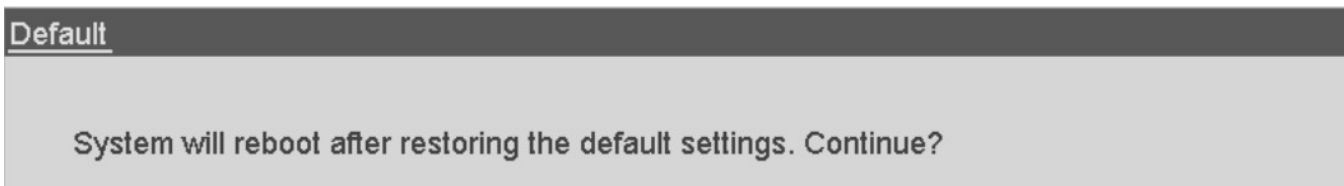
The screenshot shows a web interface for local upgrade. At the top, there are two tabs: "Local Upgrade" and "FTP", with "FTP" being the active tab. Below the tabs is a text input field labeled "FTP Server Address" containing the IP address "172.66.2.142".

3. Enter the FTP Server Address in the text field.
4. Click the "Upgrade" button to start upgrading.
5. After the upgrading is complete, reboot the NVR to activate the new firmware.

15.6. Restoring the Default Settings

Steps:

1. Enter the Default interface: Menu> Maintenance> Default



The screenshot shows a confirmation dialog box with the text "System will reboot after restoring the default settings. Continue?". The word "Default" is visible in the top left corner of the interface.

2. Click the "OK" button to restore the default settings.

NOTE: Except the network parameters (including IP address, subnet mask, gateway, MTU, NIC working mode, default route and server port), all other parameters of the device will be restored to factory default settings.

16. Other Functions

16.1. Configuring the RS-232 Serial Port

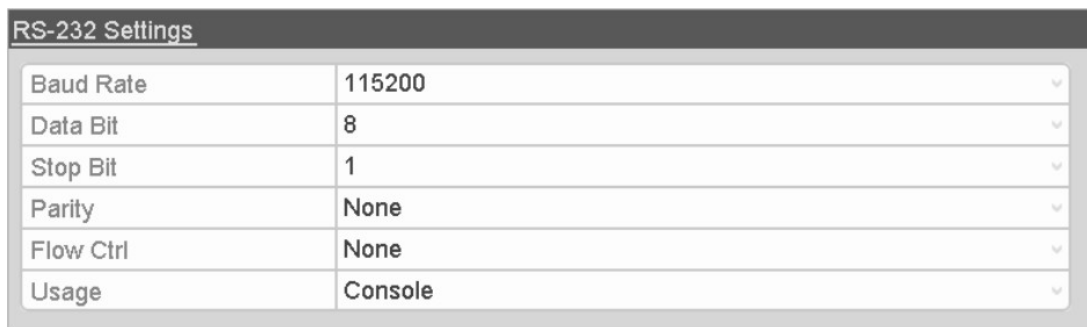
The RS-232 Serial Port is only provided for the NVR models GRN-M1116N & GRN-M1232N.

The RS-232 port can be used in two ways:

- Parameters Configuration: Connect a PC to the NVR through the PC serial port. The Device parameters can be configured by using a software such as HyperTerminal. The serial port parameters must be the same as the NVR's when connecting with the PC serial port.
- Transparent Channel: Connect a serial device directly to the NVR. The serial device will be controlled remotely by the PC through the network and the protocol of the serial device.

Steps:

1. Enter the RS-232 Settings interface: Menu> Configuration> RS-232



RS-232 Settings	
Baud Rate	115200
Data Bit	8
Stop Bit	1
Parity	None
Flow Ctrl	None
Usage	Console

2. Configure the RS-232 parameters, including the baud rate, data bit, stop bit, parity, flow control and usage.
3. Click the "Apply" button to save the settings.

16.2. Configuring the General Settings

You can configure the BNC output standard, VGA output resolution, mouse pointer speed through the Menu> Configuration> General interface.

Steps:

1. Enter the General Settings interface: Menu> Configuration> General
2. Select the "General" tab.

3. Configure the following settings:

- Language: The default language used is English.
- Resolution: Select the resolution for the video output, which must be the same as the resolution of the monitor screen.
- Time Zone: Select the time zone.
- Date Format: Select the date format.
- System Date: Select the system date.
- System Time: Select the system time.
- Mouse Pointer Speed: Set the speed of the mouse pointer; 4 levels are configurable.
- Enable Wizard: Enable/disable the Wizard when the device starts up.
- Enable Password: Enable/disable the use of the login password.

4. Click the "Apply" button to save the settings.

16.3. Configuring the DST Settings

Steps:

1. Enter the General Settings interface: Menu > Configuration> General
2. Choose the “DST Settings” tab.

General <u>DST Settings</u> More Settings						
<input type="checkbox"/> Auto DST Adjustment						
Enable DST <input type="checkbox"/>						
From	Apr	1st	Sun	2	:	00
To	Oct	last	Sun	2	:	00
DST Bias	60 Minutes					

You can check the checkbox in front of the Auto DST Adjustment item. Or you can manually check the “Enable DST” checkbox, and then you choose the date of the DST period.

16.4. Configuring More Settings for the Device Parameters

Steps:

1. Enter the General Settings interface: Menu> Configuration> General
2. Click the “More Settings” tab to enter the More Settings interface, as shown in below.

Alarm Host IP	
Alarm Host Port	0
Server Port	8000
HTTP Port	80
Multicast IP	
RTSP Port	554

3. Configure the following settings:

- Device Name: Edit the name of the NVR.
- Device No.: Edit the serial number of the NVR. The Device No. Can be set in the range of 1~255, and the default No. Is 255. The number is used for the remote and keyboard control.
- Auto Logout: Set the timeout time for menu inactivity. E.g., when the timeout time is set to 5 Minutes, then the system will exit from the current operation menu to change to the live view screen after 5 minutes of menu inactivity.
- Menu Output Mode: You can choose that the menu display is on a different video output. By default, only HDMI/VGA is selectable.

4. Click the “Apply” button to save the settings.

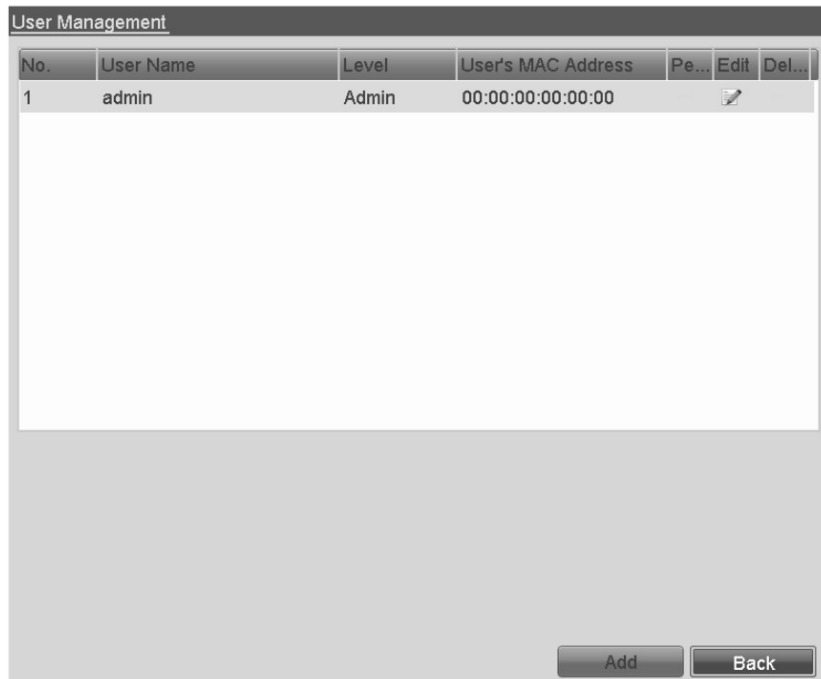
16.5. Managing User Accounts

There is a default account in the NVR: Administrator. The Administrator user name is admin and the password is 1234. The Administrator has the permission to add and delete a user and configure the user parameters.

16.5.1. Adding a User

Steps:

1. Enter the User Management interface: Menu > Configuration > User



2. Click the "Add" button to enter the "Add User" interface.

The screenshot shows a window titled "Add User". It contains the following fields:

User Name	test
Password	*****
Confirm	*****
Level	Guest
User's MAC Address	00 :00 :00 :00 :00 :00

At the bottom right of the window, there are two buttons: "OK" and "Cancel".

3. Enter the information for the new user, including User Name, Password, Level and the User's MAC Address.

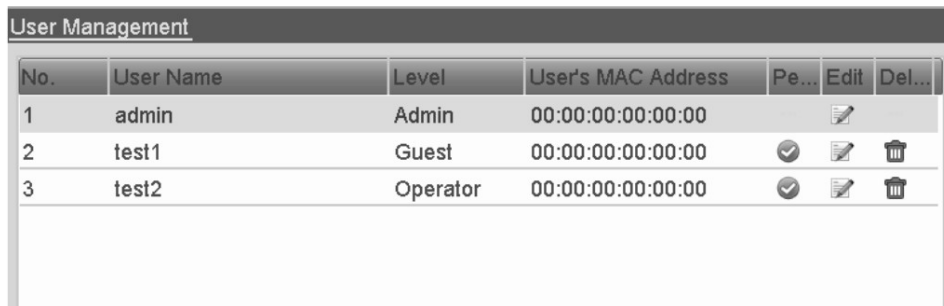
- Level: Set the user level to "Operator" or "Guest". Different user levels have different operating permission.

> Operator: The Operator user level has permission for the Two-way Audio in Remote Configuration and all operating permissions in the Camera Configuration by default.

> Guest: The Guest user has no permission for the Two-way Audio in Remote Configuration and only has the local/remote playback permission in the Camera Configuration by default.

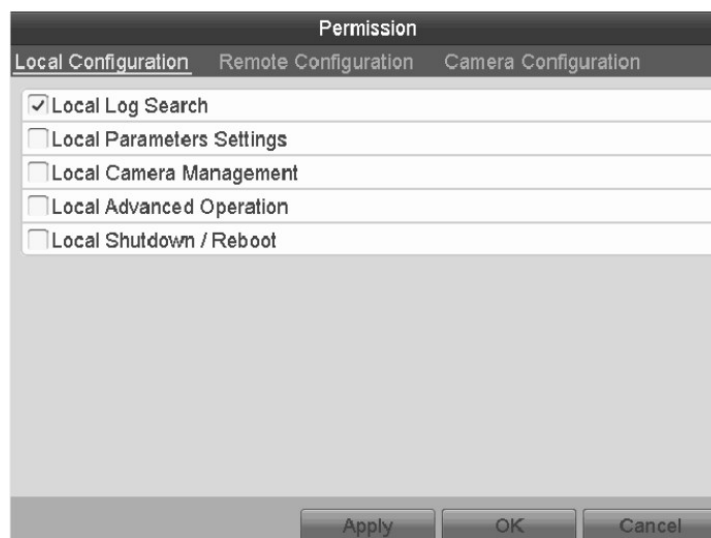
- User's MAC Address: The MAC address of the remote PC which logs onto the NVR. If it is configured and enabled, it only allows a remote user with this MAC address to access the NVR.

4. Click the "OK" button to save the settings and go back to the "User Management" interface. The added new user will be displayed on the list, as shown below.



No.	User Name	Level	User's MAC Address	Pe...	Edit	Del...
1	admin	Admin	00:00:00:00:00:00			
2	test1	Guest	00:00:00:00:00:00	✓		
3	test2	Operator	00:00:00:00:00:00	✓		

5. Select the user from the list and then click the "(tick)" button to enter the Permission settings interface, as shown below.



Permission

Local Configuration Remote Configuration Camera Configuration

Local Log Search

Local Parameters Settings

Local Camera Management

Local Advanced Operation

Local Shutdown / Reboot

Apply OK Cancel

6. Set the operating permission for the Local Configuration, Remote Configuration and Camera Configuration for the user.

Local Configuration:

- Local Log Search: Searching and viewing logs and the system information of the NVR.

- Local Parameters Settings: Configuring the parameters, restoring the factory default parameters and importing/exporting the configuration files.

- Local Camera Management: The adding, deleting and editing of IP cameras.

- Local Advanced Operation: Operating the HDD management (initialising the HDD, setting the HDD property), upgrading the system firmware, clearing the I/O alarm output.

- Local Shutdown Reboot: Shutting down or rebooting the NVR.

Remote Configuration:

- Remote Log Search: Remotely viewing logs that are saved on the NVR.
- Remote Parameters Settings: Remotely configuring parameters, restoring factory default parameters and importing/exporting configuration files.
- Remote Camera Management: Remote adding, deleting and editing of the IP cameras.
- Remote Serial Port Control: Configuring the settings for the RS-232 and RS-485 ports.
- Remote Video Output Control: Sending a remote button control signal.
- Two-Way Audio: Realising a two-way radio between the remote client and the NVR.
- Remote Alarm Control: Remotely arming (a notify alarm and exception message to the remote client) and controlling the alarm output.
- Remote Advanced Operation: Remotely operating the HDD management (initialising the HDD, setting the HDD property), upgrading the system firmware, clearing the I/O alarm output.
- Remote Shutdown/Reboot: Remotely shutting down or rebooting the NVR.

Camera Configuration:

- Remote Live View: Remotely viewing the live video of the selected camera(s).
- Local Manual Operation: Locally starting/stopping the manual recording and alarm output of the selected camera(s).
- Remote Manual Operation: Remotely starting/stopping the manual recording and alarm output of the selected camera(s).
- Local Playback: Locally playing back the recorded files of the selected camera(s).
- Remote Playback: Remotely playing back the recorded files of the selected camera(s).
- Local PTZ Control: Locally controlling the PTZ movement of the selected camera(s).
- Remote PTZ Control: Remotely controlling the PTZ movement of the selected camera(s).
- Local Video Export: Locally exporting the recorded files of the selected camera(s).

7. Click the "OK" button to save the settings and exit the interface.

NOTE: The provision of the Remote Serial Port Control, Remote Alarm Control and Local PTZ Control depends on different models.

NOTE: Only the admin user account has the permission of restoring the factory default parameters.

16.5.2. Deleting a User

Steps:

1. Enter the User Management interface: Menu> Configuration> User
2. Select the user to be deleted from the list, as shown below.



No.	User Name	Level	User's MAC Address	Pe...	Edit	Del...
1	admin	Admin	00:00:00:00:00:00	-		-
2	test1	Guest	00:00:00:00:00:00			
3	test2	Operator	00:00:00:00:00:00			

3. Click the "(red bin)" icon to delete the selected user.

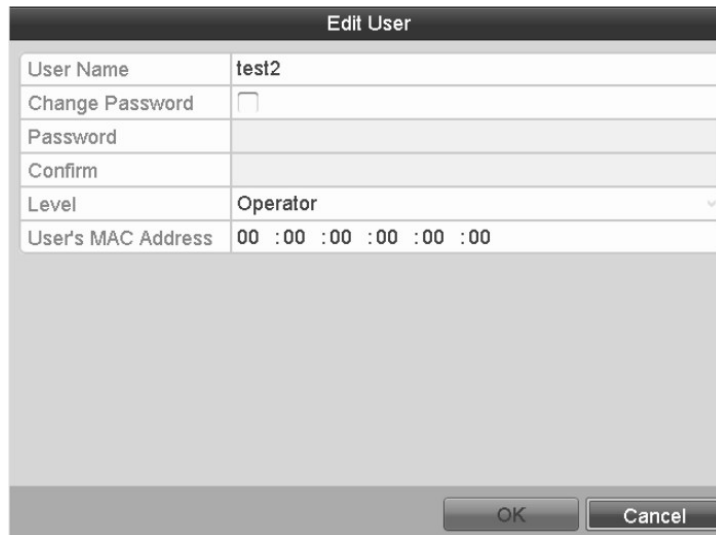
16.5.3. Editing a User

Steps:

1. Enter the User Management interface: Menu > Configuration > User
2. Select the user to be edited from the list, as shown in the picture "Operator and Guest" below.
3. Click the icon on the "[pencil on a written sheet]" button to enter the Edit User interface, as shown in the picture "Admin" below.

NOTE: The admin user can also be edited.

For Operator and Guest:

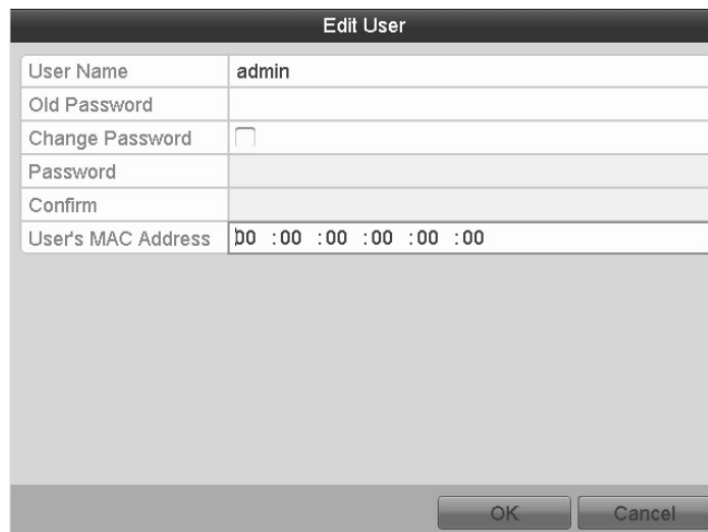


The screenshot shows a dialog box titled "Edit User". It contains a table with the following fields:

User Name	test2
Change Password	<input type="checkbox"/>
Password	
Confirm	
Level	Operator
User's MAC Address	00 :00 :00 :00 :00 :00

At the bottom right of the dialog box are two buttons: "OK" and "Cancel".

For Admin:



The screenshot shows a dialog box titled "Edit User". It contains a table with the following fields:

User Name	admin
Old Password	
Change Password	<input type="checkbox"/>
Password	
Confirm	
User's MAC Address	d0 :00 :00 :00 :00 :00

At the bottom right of the dialog box are two buttons: "OK" and "Cancel".

4. Edit the corresponding parameters.

- Operator and Guest:

You can edit the user information, including the user name, password, permission level and MAC address. Check the checkbox next to "Change Password" if you want to change the password, and input the new one in the text field of "Password" and "Confirm".

- Admin:

You are only allowed to edit the password and MAC address. Check the checkbox next to "Change Password" if you want to change the password, and input the correct old password in the field "Old Password", and the new one in the text fields of "Password" and "Confirm".

5. Click the "OK" button to save the settings and exit the menu.

17. Glossary

- Dual Stream: Dual stream is a technology used to record high resolution video locally while transmitting a lower resolution stream over the network. The two streams are generated by the DVR, with the main stream having a maximum resolution of 4CIF and the sub-stream having a maximum resolution of CIF.
- HDD: Acronym for a Hard Disk Drive. A storage medium which stores digitally encoded data on platters with magnetic surfaces.
- DHCP: Dynamic Host Configuration Protocol (DHCP) is a network application protocol used by devices (DHCP clients) to obtain the configuration information for the operation on an Internet Protocol network.
- HTTP: Acronym for the Hypertext Transfer Protocol which is a protocol to transfer the hypertext request and information between servers and browsers over a network.
- PPPoE: PPPoE, Point-to-Point Protocol over Ethernet, is a network protocol for encapsulating the Point-to-Point Protocol (PPP) frames inside Ethernet frames. It is used mainly with ADSL services where individual users connect to the ADSL transceiver (modem) over the Ethernet and in plain Metro Ethernet networks.
- DDNS: Dynamic DNS is a method, protocol, or network service that provides the capability for a networked device, such as a router or computer system using the Internet Protocol Suite, to notify a domain name server to change, in real time (ad-hoc), the active DNS configuration of its configured hostnames, addresses or other information stored on the DNS.
- Hybrid DVR: A hybrid DVR is a combination of a DVR and NVR.
- NTP: Acronym for the Network Time Protocol which is a protocol designed to synchronise the clocks of computers over a network.
- NTSC: Acronym for National Television System Committee. NTSC is an analogue television standard used in such countries as the United States and Japan. Each frame of an NTSC signal contains 525 scan lines at 60Hz.
- NVR: Acronym for a Network Video Recorder. An NVR can be a PC-based or an embedded system used for centralised management and as a storage for IP cameras, IP Domes and other DVRs.
- PAL: Acronym for the Phase Alternating Line. PAL is also another video standard used in broadcast television systems in large parts of the world. The PAL signal contains 625 scan lines at 50Hz.
- PTZ: Acronym for Pan, Tilt, Zoom. PTZ cameras are motor driven systems that allow the camera to pan left and right, tilt up and down and zoom in and out.
- USB: Acronym for the Universal Serial Bus. USB is a plug-and-play serial bus standard to interface devices to a host computer.

18. Trouble Shooting

- No image displayed on the monitor after starting up normally.

Possible Reasons:

- a) No VGA or HDMI connections.
- b) The connection cable is damaged.
- c) The input mode of the monitor is incorrect.

Steps:

1. Verify the device is connected with the monitor via a HDMI or VGA cable. If not, please connect the device with the monitor and reboot.
2. Verify the connection cable is good. If there is still no image display on the monitor after rebooting, please check if the connection cable is good, and change a cable to connect again.
3. Verify the input mode of the monitor is correct. Please check the input mode of the monitor matches with the output mode of the device (e.g. if the output mode of the NVR is a HDMI output, then the input mode of the monitor must be the HDMI input). And if not, please modify the input mode of monitor.
4. Check if the fault is solved by step 1 to step 3. If it is solved, finish the process. If not, please contact the manufacturer of the IP camera.

- There is an audible warning sound (“Di-Di-Di-DiDi”) after a new bought NVR starts up.

Possible Reasons:

- a) No HDD is installed in the device.
- b) The installed HDD has not been initialised.
- c) The installed HDD is not compatible with the NVR or has broken down.

Steps:

1. Verify whether at least one HDD is installed in the NVR.

1) If not, please install the compatible HDD.

NOTE: Please refer to the “Quick Operation Guide” for the HDD installation steps.

2) If you don't want to install a HDD, select “Menu> Configuration> Exceptions”, and uncheck the Audible Warning checkbox of “HDD Error”.

2. Verify that the HDD is initialised.

1) Select “Menu>HDD>General”.

2) If the status of the HDD is “Uninitialized”, please check the checkbox of the corresponding HDD and click the “Init” button.

3. Verify the HDD is detected or is in good condition.

1) Select “Menu> HDD> General”.

2) If the HDD is not detected or the status is “Abnormal”, please replace the dedicated HDD according to the requirement.

4. Check if the fault is solved by step 1 to step 3. If it is solved, finish the process. If not, please contact the manufacturer of the IP camera.

- The status of the added IP camera displays “Disconnected” when it is connected through a Private Protocol. Select “Menu> Camera> Camera> IP Camera” to get the camera status.

Possible Reasons:

- a) Network failure, and the NVR and IP camera lost connections.
- b) The configured parameters are incorrect when adding the IP camera.
- c) Insufficient bandwidth.

Steps:

1. Verify the network is connected.

- 1) Connect the NVR and PC with the RS-232 cable.
- 2) Open the Super Terminal software, and execute the ping command. Input “ping IP” (e.g. ping 172.6.22.131).

NOTE: Simultaneously press Ctrl and C to exit the ping command. If there exists a return information and the time value is little, the network is normal.

2. Verify the configuration parameters are correct:

- 1) Select “Menu> Camera> Camera> IP Camera”.
- 2) Verify the following parameters are the same with those of the connected IP devices, including IP address, protocol, management port, user name and password.

3. Verify whether the bandwidth is enough.

- 1) Select “Menu> Maintenance> Net Detect> Network Stat.”.
- 2) Check the usage of the access bandwidth, and see if the total bandwidth has reached its limit.

4. Check if the fault is solved by step 1 to step 3. If it is solved, finish the process. If not, please contact the manufacturer of the IP camera.

- The IP camera frequently goes online and offline and the status of it displays "Disconnected".

Possible Reasons:

- a) The IP camera and the NVR versions are not compatible.
- b) Unstable power supply of the IP camera.
- c) Unstable network between the IP camera and the NVR.
- d) Limited flow by the switch connected with the IP camera and NVR.

Steps:

1. Verify the IP camera and the NVR versions are compatible.

1) Enter the IP camera Management interface "Menu> Camera> Camera> IP Camera", and view the firmware version of the connected IP camera.

2) Enter the System Info interface "Menu> Maintenance> System Info> Device Info", and view the firmware version of the NVR.

2. Verify whether the power supply of the IP camera is stable.

1) Verify that the power indicator is normal.

2) When the IP camera is offline, please try the ping the command on the PC to check if the PC connects with the IP camera.

3. Verify whether the network between the IP camera and the NVR is stable.

1) When the IP camera is offline, connect the PC and NVR with the RS-232 cable.

2) Open the Super Terminal, use the ping command and keep sending large data packages to the connected IP camera, and check if there exists any packet loss.

NOTE: Simultaneously press "Ctrl" and "C" to exit the ping command.

Example: Input ping 172.6.22.131 -l 1472 -f.

4. Verify that the switch is not 'flow control'.

Check the brand, model of the switch connecting the IP camera and the NVR, and contact the manufacturer of the switch to check if it has the function of 'flow control'. If so, please turn it down.

5. Check if the fault is solved by step 1 to step 4. If it is solved, finish the process. If not, please contact the manufacturer of the IP camera.

- No monitor is connected with the NVR locally and when you manage the IP camera to connect with the device by web browser remotely, the status of the web browser displays as Connected. When you connect the device with the monitor afterwards via the VGA or HDMI interface and reboot the device, there is a black screen shown with the mouse cursor.

When you connect the NVR with the monitor before starting up via the VGA or HDMI interface, and manage the IP camera to connect with the device locally or remotely, the status of IP camera displays as Connected.

Possible Reasons:

After connecting the IP camera to the NVR, the image is output via the main spot interface by default.

Steps:

1. Enable the output channel.
2. Select "Menu> Configuration> Live View> View", and select the video output interface in the drop-down list and configure the window you want to view.

NOTE:

- The view settings can only be configured by the local operation of the NVR.
- Different camera orders and window-division modes can be set for different output interfaces separately, and digits like "D1" and "D2" stand for the channel number, and "X" means the selected window has no image output.

3. Check if the fault is solved by the above steps.

If it is solved, finish the process. If not, please contact the manufacturer of the IP camera.

- Live view gets stuck when video is output locally.

Possible Reasons:

- a) Poor network between the NVR and the IP camera, and there exists a packet loss during the transmission.
- B) The frame rate has not reached the real-time frame rate.

Steps:

1. Verify that the network between the NVR and the IP camera is connected.

1) When the image is stuck, connect the RS-232 ports on the PC and the rear panel of the NVR with the RS-232 cable.

2) Open the Super Terminal, and execute the command of "ping 192.168.0.0 -l 1472 -f" (the IP address may change according to the real condition), and check if there exists a packet loss.

NOTE: Simultaneously press "Ctrl" and "C" to exit the ping command.

2. Verify the frame rate is the real-time frame rate.

Select "Menu> Record> Parameters> Record", and set the "Frame rate" to "Full Frame".

3. Check if the fault is solved by the above steps. If it is solved, finish the process. If not, please contact the manufacturer of the IP camera.

- Live view gets stuck when video is output remotely via the Internet Explorer or a platform software.

Possible Reasons:

- a) Poor network connection between the NVR and the IP camera, and there exists a packet loss during the transmission.
- B) Poor network connection between the NVR and the PC, and there exists a packet loss during the transmission.
- C) The performances of the hardware are not good enough, including CPU, memory, etc..

Steps:

1. Verify that the network between the NVR and the IP camera is connected.

1) When the image is stuck, connect the RS-232 ports on the PC and the rear panel of the NVR with the RS-232 cable.

2) Open the Super Terminal, and execute the command of "ping 192.168.0.0 -l 1472 -f" (the IP address may change according to the real condition), and check if there exists a packet loss.

NOTE: Simultaneously press "Ctrl" and "C" to exit the ping command.

2. Verify that the network between the NVR and the PC is connected.

1) Open the cmd window in the Start menu, or you can press "windows+R" shortcut key to open it.

2) Use the ping command to send a large packet to the NVR, execute the command of "ping 192.168.0.0 -l 1472 -f" (the IP address may change according to the real condition), and check if there exists a packet loss.

NOTE: Simultaneously press "Ctrl" and "C" to exit the ping command.

3. Verify that the hardware of the PC is good enough.

Simultaneously press "Ctrl", "Alt" and "Delete" to enter the windows task management interface, as shown in the

- Select the "Performance" tab; check the status of the CPU and Memory.

- If the resource is not enough, please end some unnecessary processes.

4. Check if the fault is solved by the above steps. If it is solved, finish the process. If not, please contact the manufacturer of the IP camera.

- When using the NVR to get the live view audio, there is no sound or there is too much noise, or the volume is too low.

Possible Reasons:

- a) The cable between the pickup and the IP camera is not connected well; impedance mismatches or is incompatible.
- b) The stream type is not set as "Video & Audio".
- c) The encoding standard is not supported by the NVR.

Steps:

1. Verify that the cable between the pickup and the IP camera is connected well; that the impedance matches and is compatible. Log in to the IP camera directly, and turn the audio on, check if the sound is normal. If not, please contact the manufacturer of the IP camera.

2. Verify that the setting parameters are correct.

Select "Menu> Record> Parameters> Record", and set the Stream Type as "Audio & Video".

3. Verify that the audio encoding standard of the IP camera is supported by the NVR. The NVR supports G722.1 and G711 standards, and if the encoding parameter of the input audio is not one of the previous two standards, you can log in to the IP camera to configure it to the supported standard.

4. Check if the fault is solved by the above steps. If it is solved, finish the process. If not, please contact the manufacturer of the IP camera.

- The image gets stuck when the NVR is playing back by single or multi-channel.

Possible Reasons:

- a) Poor network connection between the NVR and the IP camera, and there exists a packet loss during the transmission.
- b) The frame rate is not the real-time frame rate.
- c) The NVR supports up to 16-channel synchronised playback at the resolution of 4CIF, if you want a 16-channel synchronised playback at the resolution of 720p, frame extracting may occur, which leads to a slight stuck.

Steps:

1. Verify that the network between the NVR and the IP camera is connected.

1) When the image is stuck, connect the RS-232 ports on the PC and the rear panel of the NVR with the RS-232 cable.

2) Open the Super Terminal, and execute the command of "ping 192.168.0.0 -l 1472 -f" (the IP address may change according to the real condition), and check if there exists a packet loss.

NOTE: Simultaneously press the "Ctrl" and "C" to exit the ping command.

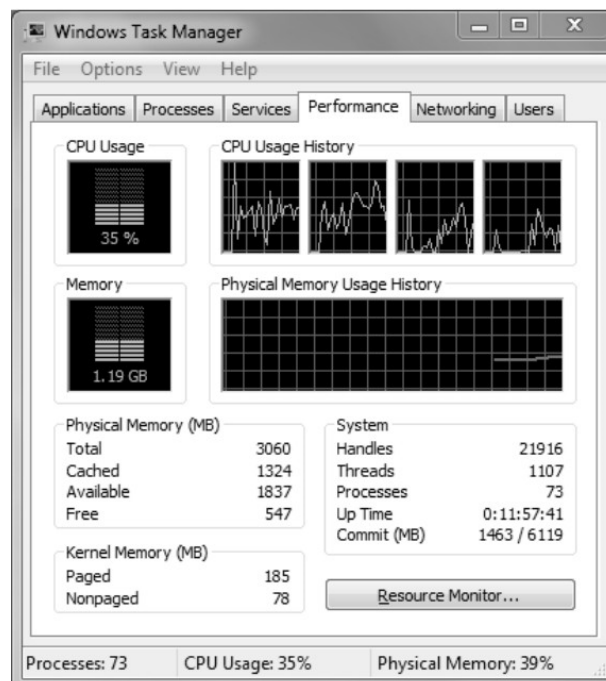
2. Verify that the frame rate is a real-time frame rate.

Select "Menu> Record> Parameters> Record", and set the Frame Rate to "Full Frame".

3. Verify that the hardware can afford the playback. Reduce the channel number of the playback. Select "Menu> Record> Encoding> Record", and set the resolution and bitrate to a lower level.

4. Reduce the number of local playback channels. Select "Menu> Playback", and uncheck the checkbox of unnecessary channels.

5. Check if the fault is solved by the above steps. If it is solved, finish the process. If not, please contact the manufacturer of the IP camera.



- No recording file is found in the NVR local HDD, and the prompt message "No record file found" appears.

Possible Reasons:

- a) The time setting of the system is incorrect.
- b) The search condition is incorrect.
- c) The HDD is in error or not detected.

Steps:

1. Verify that the system time setting is correct. Select "Menu> Configuration> General> General", and verify that the "Device Time" is correct.
2. Verify that the search condition is correct. Select "Playback", and verify that the channel and time are correct.
3. Verify that the HDD status is normal. Select "Menu> HDD> General" to view the HDD status, and verify that the HDD is detected and can be read and written normally.
4. Check if the fault is solved by the above steps. If it is solved, finish the process. If not, please contact the manufacturer of the IP camera.

Specifications GRN-G1004P

Operating System	Embedded OS
IP Inputs	4 channels
Video Outputs	1x VGA, 1x HDMI
Harddisk bay	1 x SATA II
Video Compression	H.264
Recording Resolution	VGA (640x480), 4CIF (704x576), 720p (1280x720), 1.3MP (1280x960), UXGA (1600x1200), 1080p (1920x1080), QXGA (2048x1536), 5MP (2560x1920, 6MP (3072 × 2048)
Recording Bandwidth	max. 40 Mbps
Outgoing Bandwidth	max. 80 Mbps
Recording Mode	Continuous, Event Alarm, Motion, Video Loss, Schedule
Display Resolution	Up to 1920x1080 (HDMI / VGA)
Display Speed	4ch @ 1080p
Playback	Synchronised playback of max. 4 cameras
Search Mode	Date/Time, Event Alarm, Motion, Search Backup
External Backup	USB HDD, USB Memory, USB External, DVD-ROM, Network
Motion Detection	On/ Off/ Area Setting
Audio Inputs	4 CH over IP
Audio Outputs	1 CH, RCA
Audio Compression	G.711
Alarm Inputs	4
Alarm Outputs	1
Network Interface	4x 10/100 Base T/TX PoE (RJ-45) + 1x 10/100/1000 Base T/TX (RJ-45)
PoE Budget	50 W
Remote Connections	Up to 128 (depending on available outgoing bandwidth)
Network Protocol	IPv4, IPv6, TCP/IP, UDP, RTP, PPPoE, DHCP, DNS, DDNS, NTP, SADP, SMTP, SNMP, NFS, iSCSI
Serial Interface(s)	1x USB 2.0, 1x USB 3.0
Operating Temperature	-10°C ~ +55°C
Operating Humidity	10% ~ 90%, non-condensing
Supply Voltage	48 Vdc
Power Consumption	10 W
Weight	1 kg
Dimensions (wxhxd)	380 x 290 x 48 mm

Specifications GRN-G1116P

Operating System	Embedded OS
IP Inputs	16 channels
Video Outputs	1x VGA, 1x HDMI
Harddisk bay	2 x SATA II
Video Compression	H.264
Recording Resolution	VGA (640x480), 4CIF (704x576), 720p (1280x720), 1.3MP (1280x960), UXGA (1600x1200), 1080p (1920x1080), QXGA (2048x1536), 5MP (2560x1920, 6MP (3072 × 2048)
Recording Bandwidth	max. 160 Mbps
Outgoing Bandwidth	max. 80 Mbps
Recording Mode	Continuous, Event Alarm, Motion, Video Loss, Schedule
Display Resolution	Up to 1920x1080 (HDMI / VGA)
Display Speed	6 Ch @ 1080p, 12 Ch @ 720p, 16 Ch @ 4CIF
Playback	Synchronised playback of max. 16 cameras
Search Mode	Date/Time, Event Alarm, Motion, Search Backup
External Backup	USB HDD, USB Memory, USB External, DVD-ROM, Network
Motion Detection	On/ Off/ Area Setting

Audio Inputs	16 CH over IP
Audio Outputs	1 CH, RCA
Audio Compression	G.711
Alarm Inputs	4
Alarm Outputs	1
Network Interface	8x 10/100 Base T/TX PoE (RJ-45) + 1x 10/100/1000 Base T/TX (RJ-45)
PoE Budget	120 W
Remote Connections	Up to 128 (depending on available outgoing bandwidth)
Network Protocol	IPv4, IPv6, TCP/IP, UDP, RTP, PPPoE, DHCP, DNS, DDNS, NTP, SADP, SMTP, SNMP, NFS, iSCSI
Serial Interface(s)	1x USB 2.0, 1x USB 3.0
Operating Temperature	-10°C ~ +55°C
Operating Humidity	10% ~ 90%, non-condensing
Supply Voltage	100 ~ 240 Vac, 50/60Hz
Power Consumption	10 W
Weight	1 kg
Dimensions (wxhxd)	380 x 290 x 48 mm

Specifications GRN-M1116N

Operating System	Embedded OS
IP Inputs	16 channels
Video Outputs	1x VGA, 1x HDMI, 1x BNC
Harddisk bay	4 x SATA II
Video Compression	H.264
Recording Resolution	VGA (640x480), 4CIF (704x576), 720p (1280x720), 1.3MP (1280x960), UXGA (1600x1200), 1080p (1920x1080), QXGA (2048x1536), 5MP (2560x1920, 6MP (3072 x 2048)
Recording Bandwidth	max. 200 Mbps
Outgoing Bandwidth	max. 160 Mbps
Recording Mode	Continuous, Event Alarm, Motion, Video Loss, Schedule
Display Resolution	Up to 1920x1080 (HDMI / VGA), 704x576 (BNC)
Display Speed	5 Ch @ 1080p, 10 Ch @ 720p, 16 Ch @ 4CIF
Playback	Synchronised playback of max. 16 cameras
Search Mode	Date/Time, Event Alarm, Motion, Search Backup
External Backup	USB HDD, USB Memory, USB External, DVD-ROM, Network
Motion Detection	On/ Off/ Area Setting
Audio Inputs	16 channels (over IP), 1 channel (BNC, 2.0Vp-p, 1KOhms)
Audio Outputs	2 Channels (BNC, 600 Ohms)
Audio Compression	G.711
Alarm Inputs	16
Alarm Outputs	4
Network Interface	1x 10/100/1000 Base T/TX (RJ-45)
Remote Connections	Up to 128 (depending on available outgoing bandwidth)
Network Protocol	IPv4, IPv6, TCP/IP, UDP, RTP, PPPoE, DHCP, DNS, DDNS, NTP, SADP, SMTP, SNMP, NFS, iSCSI
Serial Interface(s)	1x RS232, 2x RS485, 3x USB, 1x eSATA
Operating Temperature	-10°C ~ +55°C
Operating Humidity	10% ~ 90%, non-condensing
Chassis	19-inch rack-mounted, 1.5U
Supply Voltage	100 ~ 240 Vac, 50/60Hz
Power Consumption	40 W
Weight	4 kg
Dimensions (wxhxd)	445 x 390 x 70 mm

Specifications GRN-M1232N

Operating System	Embedded OS
IP Inputs	32 channels
Video Outputs	1x VGA, 1x HDMI, 1x BNC
Harddisk bay	4 x SATA II
Video Compression	H.264
Recording Resolution	VGA (640x480), 4CIF (704x576), 720p (1280x720), 1.3MP (1280x960), UXGA (1600x1200), 1080p (1920x1080), QXGA (2048x1536), 5MP (2560x1920, 6MP (3072 x 2048)
Recording Bandwidth	max. 200 Mbps (100Mbps when RAID is enabled)
Outgoing Bandwidth	max. 160 Mbps (100Mbps when RAID enabled)
Recording Mode	Continuous, Event Alarm, Motion, Video Loss, Schedule
Display Resolution	Up to 1920x1080 (HDMI / VGA), 704x576 (BNC)
Display Speed	8 Ch @ 1080p, 16 Ch @ 720p
Playback	Synchronised playback of max. 16 cameras
Search Mode	Date/Time, Event Alarm, Motion, Search Backup
External Backup	USB HDD, USB Memory, USB External, DVD-ROM, Network
Motion Detection	On/ Off/ Area Setting
Audio Inputs	32 channels (over IP), 1 channel (BNC, 2.0Vp-p, 1KOhms)
Audio Outputs	2 Channels (BNC, 600 Ohms)
Audio Compression	G.711
Alarm Inputs	16
Alarm Outputs	4
Network Interface	1x 10/100/1000 Base T/TX (RJ-45)
Remote Connections	Up to 128 (depending on available outgoing bandwidth)
Network Protocol	IPv4, IPv6, TCP/IP, UDP, RTP, PPPoE, DHCP, DNS, DDNS, NTP, SADP, SMTP, SNMP, NFS, iSCSI
Serial Interface(s)	1x RS232, 2x RS485, 3x USB, 1x eSATA
Operating Temperature	-10°C ~ +55°C
Operating Humidity	10% ~ 90%, non-condensing
Chassis	19-inch rack-mounted, 1.5U
Supply Voltage	100 ~ 240 Vac, 50/60Hz
Power Consumption	45 W
Weight	4 kg
Dimensions (wxhxd)	445 x 90 x 70 mm

EC Declaration of Conformity



GRN-G1004P 4 Channel H.264 NVR with PoE switch
GRN-G1116P 16 Channel H.264 NVR with PoE switch
GRN-M1116N 16 Channel H.264 NVR
GRN-M1232N 32 Channel H.264 NVR

It is hereby certified that the products meet the standards in the following relevant provisions:

EC EMC Directive 2004/108/EC

Applied harmonised standards and technical specifications:

EN 55022: 2010
EN 55024: 2010
EN 61000-3-2: 2006 + A1: 2009 + A2:2009
EN 61000-3-3: 2008

ASP AG

Lüttringhauser Str. 9
42897 Remscheid
Germany

GRUNDIG

Remscheid, 15.10.2015

Ludwig Bergschneider
CEO