



DIGITAL FULL HD SPLITTER

**SC-04HDS(H)**

**User's Manual**

**SC-04HDS(H)**



## **Precaution and Safety Guidelines**

**Please read this user's manual thoroughly prior to use the unit for its easy and convenient use.**

- Do not install the product in the following places: extremely low or high temperature conditions; places exposed to rain, snow, or high humidity; places containing or exposed to oil and gas; places exposed to vibration and shock; places under direct sunlight or exposed to outdoor weather conditions; places exposed to radio waves (RF) or near to power lines. It may cause low performance or malfunction of the unit.
- Do not disassemble the product or insert foreign objects.
- The unit is subject to electric shock hazard. Be careful not to get an electric shock while using the device.
- Please use only electrical safety approved power supply unit (power adapter) over 12VDC /0.5A with electromagnetic compatibility.
- Do not use and/or connect any devices inappropriate to the unit. It may cause malfunction of the unit or fire.
- Use this product under temperature conditions only between 0°C and +50°C.
- Should be careful not to have the lines changed when connecting them.
- Prior to turn on the device, check the cable insulation condition of the data cable, connected with external devices.
- Before installing the product, check its voltage rate and then turn on the power.
- Make sure to turn off the product prior to installation.
- Do not subject the product to physical shock or exert excessive force to operate the product.
- Do not use the device when any smoke or smell is produced from the unit. It may be subject to fire or electric shock. If any smoke or smell is produced, please turn off the unit and remove the power cable immediately, and contact your distributor to check the device properly.
- If the power does not turn ON, please check whether the power cable is connected correctly or not.
- If the device does not work properly, please contact your distributor.

# 1. Introduction

## 1-1. Overview

The SC-04HDS, a Digital Full HD Splitter, offers a high resolution display for video signals received from max. four SD (standard definition) CCTV cameras with 720\*480 Pixel. And it splits the screen in various formats from full screen to 4 screens display mode without deterioration. Also, it displays the video clearly in a Full HD monitor with 1920\*1080P high resolution.

With this device, it is possible to amplify video signals to an external device such as the DVR from the Loop Through terminal. And a remote control operation is available through the RS-232C / RS-485 port. It displays the date and time, the name of channel on the monitor, as well as when it occurs any channel loss.





## 1-2. Features

- Displaying high resolution pictures and rapid image processing by the SOC chip
- Displaying video from 4 cameras at real time
- Auto sequence mode
- Motion Detect Automatic Transitions
- Pattern change detection function
- Supporting NTSC & PAL system
- Displaying the date and time, the name of the channel and the current status
- RS-232C / RS-485 communication port for external devices
- Various mode of screen split (1, 2H, 2V, 4B, 4R, 4)

## 1-3 Applications

- Where a centralized supervisory and control system is needed such as the control center at Subway, Airport, Port and etc,
- At a control center of large buildings and express way and etc.

# 2. Components

SC-04HDS	Rack mount bracket	Power Adapter	User's Manual
			

- HDMI cable (3m)

### 3. Product Parts and Peripheral Device Connection

#### 3-1. Name of Parts and Function

##### 3-1-1. SC-04HDS(H)

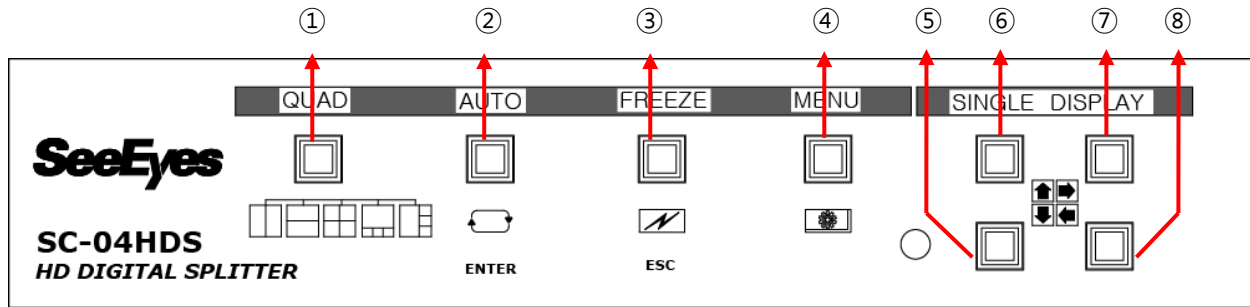

Button	Function
① QUAD	It shows the pictures of 2 channels in vertical and horizontal mode, or the pictures of 4 channels in 4B/R mode.
② AUTO	- In full screen mode, press this button to display the screen in auto sequence mode according to the dwell time adjusted in each channel. - In the menu mode, it operates as ENTER key.
③ FREEZE	- In a single display mode (1ch, FULL screen), it freezes the video displayed in full screen. If you press any button when the video is freeze, it unfreezes the video and it activates the pressed button function. - In split mode, it freezes all the videos displayed in the screen. Then, if you press the single display button, it freezes and unfreezes the video displayed in the screen. To unfreeze the video, press this button one more time. - In the menu mode, it operates as ESC button. - In Freeze mode, the LED indicator of Freeze button flickers.
④ MENU	Press this button to display the Setup Menu in pop-up mode.
⑤ ~ ⑧ SINGLE DISPLAY	- The left upper button displays the video of Ch1 (⑥), the right upper button displays the Ch2, the right bottom button displays the Ch3 and the left bottom button shows the Ch4 in single mode. - In menu mode, it operates as direction key. It moves to ↑, →, ←, ↓ respectively from the left upper button. Or, press these direction buttons to set the menu value. - In QUAD or SEQUENCE mode, it displays the video selected in full screen.

#### ● Quad mode

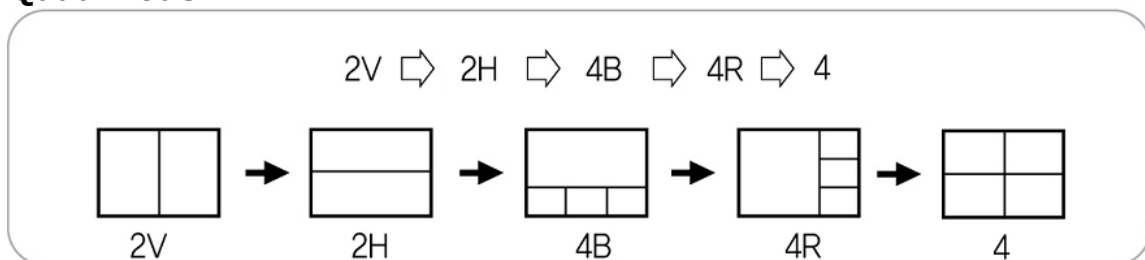

### 3-1-2. SC-04HDS rear side (connection port)

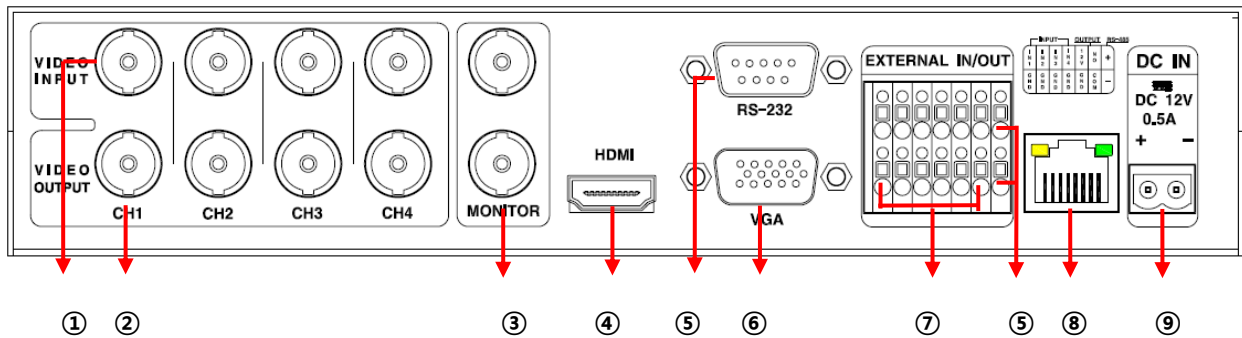

- ① **VIDEO INPUT:** Connect the four (4) cameras
- ② **VIDEO OUT (Loop Through):** It distributes the four (4) input video signals to other devices by loop trough.
- ③ **MONITOR (Spot) Output:** Connect the SD (standard definition) Video Monitor.
  - You can watch the picture of specific channel through the Monitor output, independently from the video out in live through the HDMI, DVI and VGA output.
  - Selection of Monitor output display
    1. Select MENU < SCREEN SETTING < SPOT
    2. Press the MENU > ◀▶ buttons in display menu mode, then press [Enter] > ▲▼ buttons. And then, press the [Enter] > +, - button to change the setup value.
    3. (Ch1~Ch4, HD04), HD04 displays the same picture as the picture displayed through HDMI port.
    4. You can put out a single picture of 1~4CH or the picture entered through HDMI port through the Monitor output port.
    5. You can watch two equal pictures through two BNC-F terminals of Monitor port.
- ④ **HDMI:** Connect the HD (High Definition) Monitor with HDMI input port.
- ⑤ **Serial Port:** Connect the RS-232C/ RS-485 to link external devices for remote control function.
  - Data configuration
    - Data Length: 8 Bit, Start/Stop Bit: 1Bit, Parity Bit: None, Baud rate: 9,600 bps
    - Packet structure
    - Control Communication Data format

Byte	Value	Function
1	0xA0	STX (Launching Data)
2	0x00 ~ 0xFF	0x16 (Device Code)
3	0x00 ~ 0xFF	Address (Device ID)
4	Data byte	Control Data
5	Check Sum	Check Sum = Byte2 + Byte3 + Byte4

- Control DATA Code

NO	Hex	ASCII	Function	Remarks
1	0x30 ~ 0x33	0 ~ 3	Display in Full CH 01 ~ 04	Display Control
2	0x47	G	Multi Screen	"
3	0x48	H	Menu	
4	0x49	I	Enter	
5	0x4A	J	ESC	
6	0x50	P	Display 4ch in split mode	Display Control
7	0x51	Q	Display 2 ch in vertical split	"
8	0x52	R	Display 2 ch in horizontal split	"
9	0x53	S	Display 4-1 split	"
10	0x54	T	Display 4-2 split	"
11	0x5A	Z	Auto Sequence	
12	0x64	d	Down	Menu move
13	0x6C	l	Left	"
14	0x72	r	Right	"
15	0x75	u	Up	"

⑥ **VGA:** Connect the Monitor with the VGA input (Only SZGA, WSXGA is available).

⑦ **ALARM INPUT/ OUPUT**

Connect the alarm input/output port to control the split display screen by a foreign sensor or switch connected.

- Display mode per Foreign Alarm Input

Foreign Input				Display mode
IN1	IN2	IN3	IN4	
0	0	0	0	Normal Mode
1	0	0	0	CH 1 Full Display
0	1	0	0	CH 2 Full Display
1	1	0	0	CH 1, CH2 Dual Display
0	0	1	0	CH 3 Full Display
1	0	1	0	CH 1, CH3 Dual Display
0	1	1	0	CH 2, CH3 Dual Display
1	1	1	0	QUAD Display
0	0	0	1	CH 4 Full Display
1	0	0	1	CH 1, CH4 Dual Display
0	1	0	1	CH 2, CH4 Dual Display
1	1	0	1	QUAD Display
0	0	1	1	CH 3, CH4 Dual Display
1	0	1	1	QUAD Display
0	1	1	1	QUAD Display
1	1	1	1	QUAD Display

※ Input OFF mode = "0", Input ON mode = "1" (The GND and the Inx produce a short circuit )

- ※ When an Alarm is entered, an "A" appears in the video which have received the alarm, in the place in which the channel loss is indicated.
- ※ The Alarm input will not operate if an alarm signal is entered into a lost channel.

### ⑦-1. Alarm Input & Button Function

In Alarm input mode or external data control model, you can only enter to the menu mode and other function button may not operate. During the Alarm Hold Time, press any button to escape from Alarm mode.

### ⑦-2. Alarm Input Cancel

When the external control data or Alarm input is eliminated, it returns to the last display mode which has been displayed before the external data has entered, after the Alarm Hold Time is ended. You can set the Alarm Hold Time in the Alarm Time menu in System/Display < SETUP MENU.

### ⑦-3. Alarm Input Timing Structure

When the Alarm or the external data is in, the screen is displayed and the buzzer operates as following timing diagram.

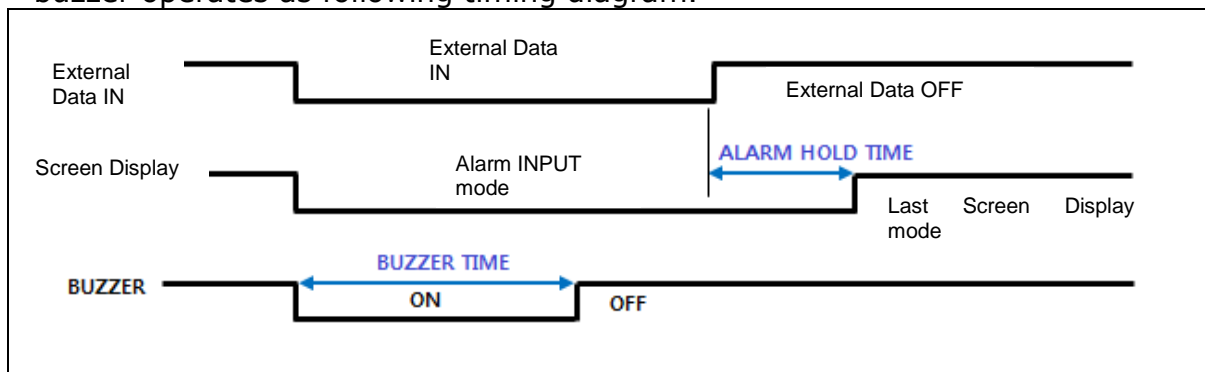

- ※ The Alarm Hold Time is hold as long as the Buzzer Time last. (Alarm Hold Time = Buzzer Time)

### ⑦-4. How to put the Alarm in

Use a contact point signal such as switches or relay to Open/Short the Inx and the GND (Alarm Input port). Do not use any contact point with electrical signal. It may cause any malfunction of the device.

### ⑦-5 Alarm Output

The Alarm output provides the connect point to activate a warning lamp or alarm bell when an alarm is entered.

### ⑦-6. Alarm Output Contact Point

The Alarm output contact point is under Normal Open relay of 1A/24VDC, 0.5A/125 VAC.

- ※ The relay may not activate properly when an overrated power is applied in the alarm output contact point.

### ⑦-7. Function

The relay maintains closed when any external input is ON, that is, when the Alarm Input port is produced a short circuit.

The relay maintains open when any external data is off or the alarm input is off after the alarm time is ended.

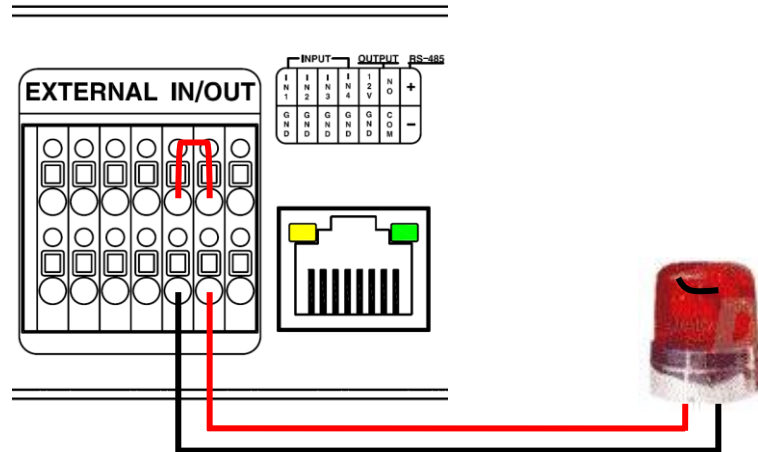

[How to connect a warning lamp to the Alarm Output port]

- ⑧ **RJ-45:** Connect the Firmware Upgrade
- ⑨ **Input Power:** over 12VDC / 500mA



## 4. Specification

MODEL		SC-04HDS		
VIDEO	INPUT		75Ω 1 Vp-p(BNC-F) X 4	
	OUTPUT		Looped through output 75Ω 1 Vp-p(BNC-F) X 4 HDMI X 1, D-SUB X 1, BNC-F X 2	
	Resolution	HDMI	Full HD	1920x1080P @50/60Hz
			HD	1920x1080i @50/60Hz
			WSXGA	1680x1050 @60Hz
			SXGA	1280x1024 @60Hz
	D-SUB		Support SXGA, WSXGA	
	BNC-F(Monitor)		720 x 480 @50/60Hz	
	FORMAT		NTSC / PAL Selectable	
	Screen splitting mode		1, 2V, 2H, 4B, 4R, 4	
OSD(On Screen Display)		Inserting up to 16 characters (alphabet and/or numbers)		
External Interface	RJ-45		Firmware upgrade	
	RS-232C / RS-485		Connection port for external devices	
	14P T. Block	ALARM	Input: 4(8P), Output: 1(2P)	
		Serial Port	1 port of RS-485 (2P)	
Power Output		DC 12V 300mA (2P)		
POWER INPUT		2P Terminal Block, over 12VDC 500mA		
Consumption Power		6W		
Temperature/Humidity		0℃ ~ +50℃ / 0 ~ 80%		
Case body / Weight		Steel/ 2Kg		
Dimensions		220(W) X 44(H) X 190(D)mm		

## 5. Menu Setup

### • How to setup the Menu

- Press Menu button, and the menu will be displayed.

※ Please refer to the button function of SC-04HDS front side (3-1-1).

- Log-in Window: If you have set the password, the below log-in window appears. The password in default is "1111". Please refer to the menu 5-5-1 on how to insert a password.

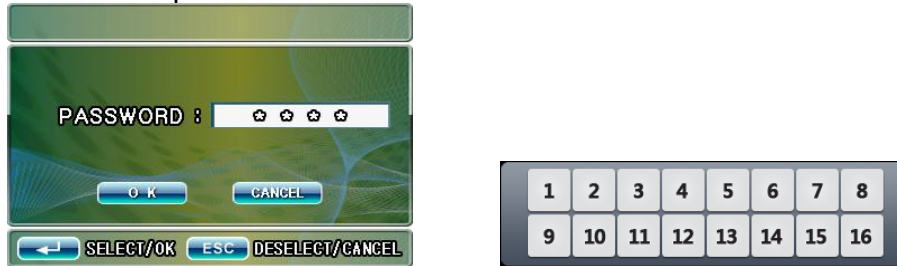

### 5-1. Menu Structure

In menu setting mode, it is possible to set up system, display, channel and log-in setting, menu structure as below.

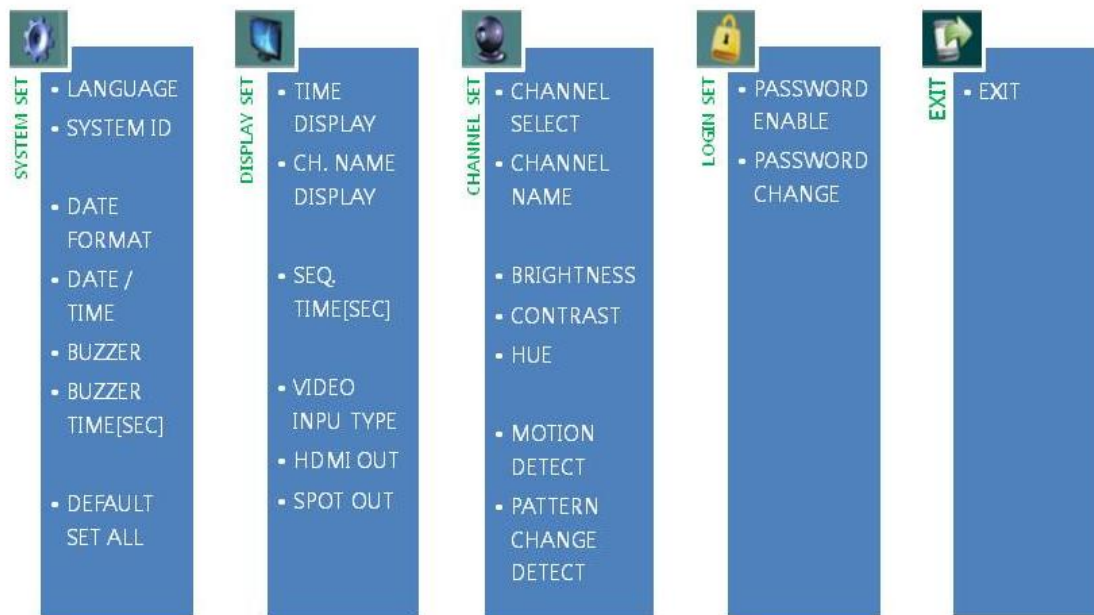

### 5-2. System Setting

In System setting, it is possible to set up Language, system ID, and date and time display format, Buzzer on/off, buzzer time.

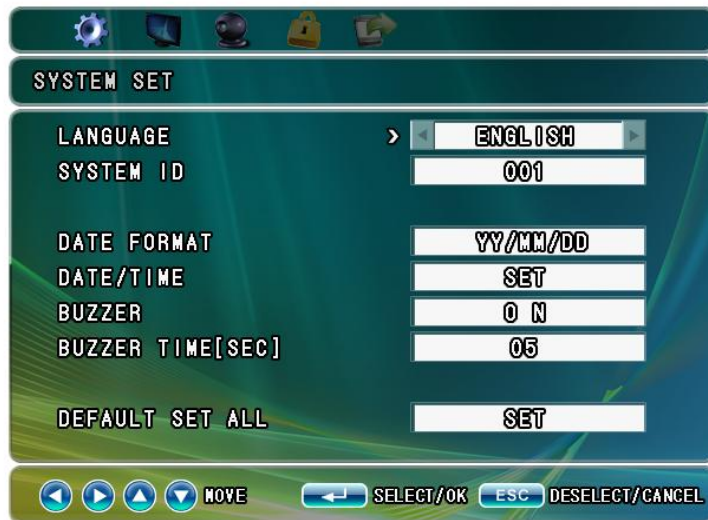

### 5-2-1. Language

In this menu, it is possible to set the system language and it supports Korean, English and Japanese.

Press the Menu > ◀▶ buttons and then press [ENTER] in system setting mode and press ▲▼ buttons. Then, press [ENTER] and select Korean, English or Japanese by pressing ◀▶ buttons.

### 5-2-2. System ID

When controlling SC-04HDS at long distance or short distance, you can use the System Id. You can insert from 1 to 255.

Press Menu Button > ◀▶ buttons, and then press [ENTER]> button in System set and ▲▼ buttons. Then, press [ENTER] in System ID and ◀▶ buttons to change the set-up value and select the number from 1 to 255.

### 5-2-3. Date Display Format

In this menu, it is possible to set the date display format.

Press Menu > press ◀▶ buttons and [ENTER] in System set > press ▲▼ buttons and [ENTER] in date display format > press ◀▶ buttons to change the set-up value and select the desired format.

### 5-2-4. Date / Time Set

In this menu, it is possible to set date / time.

Press Menu > press ◀▶ buttons and [ENTER] in System set > press ▲▼ buttons and [ENTER] in Date > press ◀▶ buttons to change the set-up value.



### 5-2-5. Buzzer

In this menu, it is possible to set the buzzer when button is used, the motion is detected and video signal loss is detected.

Press Menu > press ◀▶ buttons and [ENTER] in System set > press ▲▼ buttons and [ENTER] in Buzzer > press ◀▶ buttons to change the value.

### 5-2-6. Buzzer Time [Sec]

It is possible to set buzzer duration time.

Press Menu > press ◀▶ buttons and [ENTER] in System set > press ▲▼ buttons and [ENTER] in Buzzer Time (Sec) > press ◀▶ buttons to change the value among 1~99 seconds.

### 5-2-7. Default Set

It is possible to initialize the value, and the menu will be set to default mode.

Press Menu > press ◀▶ buttons and [ENTER] in System set > press ▲▼ buttons and [ENTER] in Default set > select (ENTER) or (ESC).

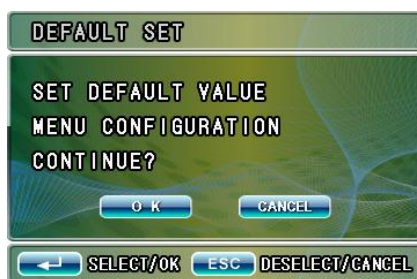

## 5-3. Display Set

In Display set, it is possible to set Time, Channel name, Sequence time, Video format (NTSC/PAL), HDMI resolution, HDMI display position, Spot display.

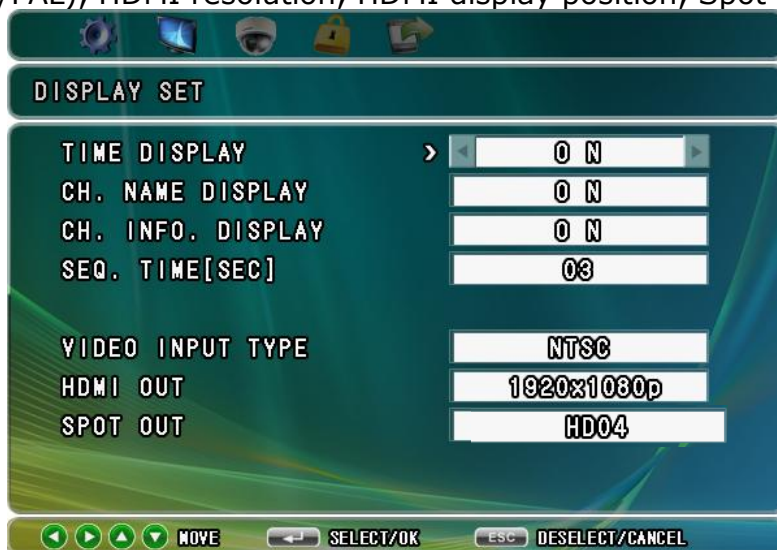

### 5-3-1. Time display

In this menu, it is possible to set the current date and time indication.

Press Menu > press ◀▶ buttons and [ENTER] in Display set > press ▲▼ buttons and [ENTER] in Time display > Press ◀▶ buttons to change the set value.

### 5-3-2. Channel Name Display

In this menu, it is possible to set the channel name indication.

Press Menu > press ◀▶ buttons and [ENTER] in Display set > press ▲▼ buttons and [ENTER] in Channel name display > Press ◀▶ buttons to change the set value.

### 5-3-3 Sequence Time [Sec]

It is possible to set the display switching time by seconds (1 sec. ~ 30 secs.) when selecting Auto Sequence mode.

Press Menu > press ◀▶ buttons and [ENTER] in Display set > press ▲▼ buttons and [ENTER] in Sequence time (Sec) > Press ◀▶ buttons to change the set value.

### 5-3-4. Video Input Type

It is possible to set the display input format.

Press Menu > press ◀▶ buttons and [ENTER] in Display set > press ▲▼ buttons and [ENTER] in Video input type > Press ◀▶ buttons to change the set value.

### 5-3-5. HDMI RESOLUTION SET

It is possible to set the picture resolution that is outputted from HDMI Port.

Before setting, please check the resolution of monitor. If the resolution is set higher than the available specification, the image may not be appeared on the screen. In this case, you must use the adequate monitor and change the configuration.

Press Menu > press ◀▶ buttons and [ENTER] in Display set > press ▲▼ buttons and [ENTER] in HDMI resolution > Press ▲▼◀▶ and [ENTER] button to select the desired resolution.

Please cancel the setting, in case that the resolution set in pop-up menu cannot be supported in the monitor.



### 5-3-6. Monitor (Spot) Out

This product also provides video signals outport for Standard Definition CVBS monitor. In this menu, it is possible to set monitor (spot) output screen.

Press Menu > press ◀▶ buttons and [ENTER] in Display set > press ▲▼ buttons and [ENTER] in CVBS > Press ◀▶ buttons to set. (CH1~CH4, HD4) HD4 displays the same split pictures as those displayed from HDMI port.

### 5-4. Channel Set

In this menu, it is possible to set up the Channel select, Channel name, Brightness, Contrast, Hue, Motion detect, Pattern change det. etc.

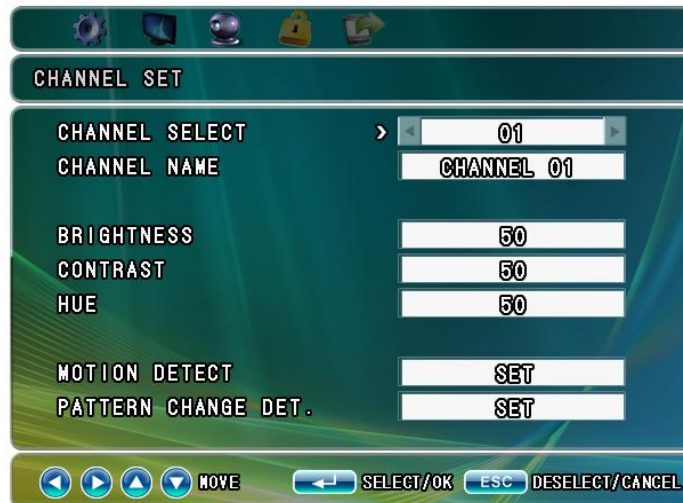

### 5-4-1. Channel Select

You can select the channel you want to set up.

Press Menu > press ◀▶ buttons and [ENTER] in Channel set > press ▲▼ buttons and [ENTER] in Channel select > Press ◀▶ buttons to select the channel you want to set up.

### 5-4-2. Channel Name

You can change the channel title (up to 10 letters).

Press Menu > press ◀▶ buttons and [ENTER] in Channel set > press ▲▼ buttons and [ENTER] in Channel select > select the letter in pop up window. (Virtual keyboard)

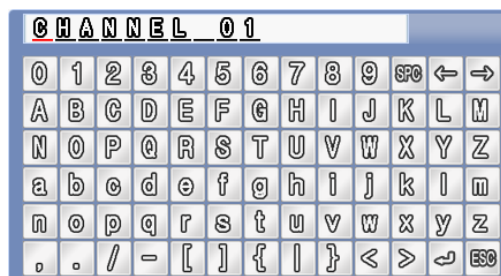

[Virtual keyboard]

- Pop-up window: The current name appears on the upper side of Pop-up window. When the red cursor appears on the bottom of the character, move the cursor and edit the name using the ◀▶ buttons image appeared in the pop-up menu. To move the character in the pop-up window, use the direction key (Single Display button). And then press [ENTER] button in virtual Keyboard to select the letter you want.

### 5-4-3. Brightness

It sets the brightness of each channel (0~99).

Press Menu > press ◀▶ buttons and [ENTER] in Channel set > press ▲▼ buttons and [ENTER] in Brightness > Press ◀▶ buttons to set up the value of brightness.

#### 5-4-4. Contrast

It sets the Contrast of each channel (0~99).

Press Menu > press ◀▶ buttons and [ENTER] in Channel set > press ▲▼ buttons and [ENTER] in Contrast > Press ◀▶ buttons to set up the value of contrast.

#### 5-4-5. HEU

It sets the Saturation of each channel (0~99).

Press Menu > press ◀▶ buttons and [ENTER] in Channel set > press ▲▼ buttons and [ENTER] in HEU > Press ◀▶ buttons to set up the value of HEU.

#### 5-4-6. Pattern change det.

It sets the Pattern Change Detection.

Press Menu > press ◀▶ buttons and [ENTER] in Channel set > press ▲▼ buttons and [ENTER] in Pattern change det. > Set the pattern change detection in the created pop up window.



Detection Function	Set the activation or deactivation of Motion/Pattern change detection function. Select among OFF, Motion and Pattern.	- Using the front function button, press the button ▲/▼ to move the cursor, press ENTER and then change the value pressing the ◀/▶.
Sensitivity	Set the sensitivity degree of motion and/or pattern change detection function. Select among Low, Normal and High.	- Using the front function button, press the button ▲/▼ to move the cursor, press ENTER and then change the value pressing the ◀/▶.
Area Set	Set the motion and/or pattern change detection area. CLEAR: It cancels the selected detection setting area. All: It selects all as detection area. Set: You can set the detection area as you want. To set the detection area, select Set and then click Enter. It will appear a cursor icon on the bottom of the menu.	- Using the front function button, press the button ▲/▼ to move the cursor, press ENTER and then change the value pressing the ◀/▶. Then, press ENTER to set the value selected.

##### 5-4-6-1. How to set the detection area (32 X 24 Dot)

- Using the function button or the remote control, move the yellow cursor icon to the area you want to start to set, then press the ◀ (select) / ▶ (cancel) button. When it appears the + or - on the yellow cursor, move the icon to select or cancel the set area.
- If you press the Freeze button, a yellow cursor will appear and it will stop the setting. If you press again the Freeze button, it will return to the set menu mode.

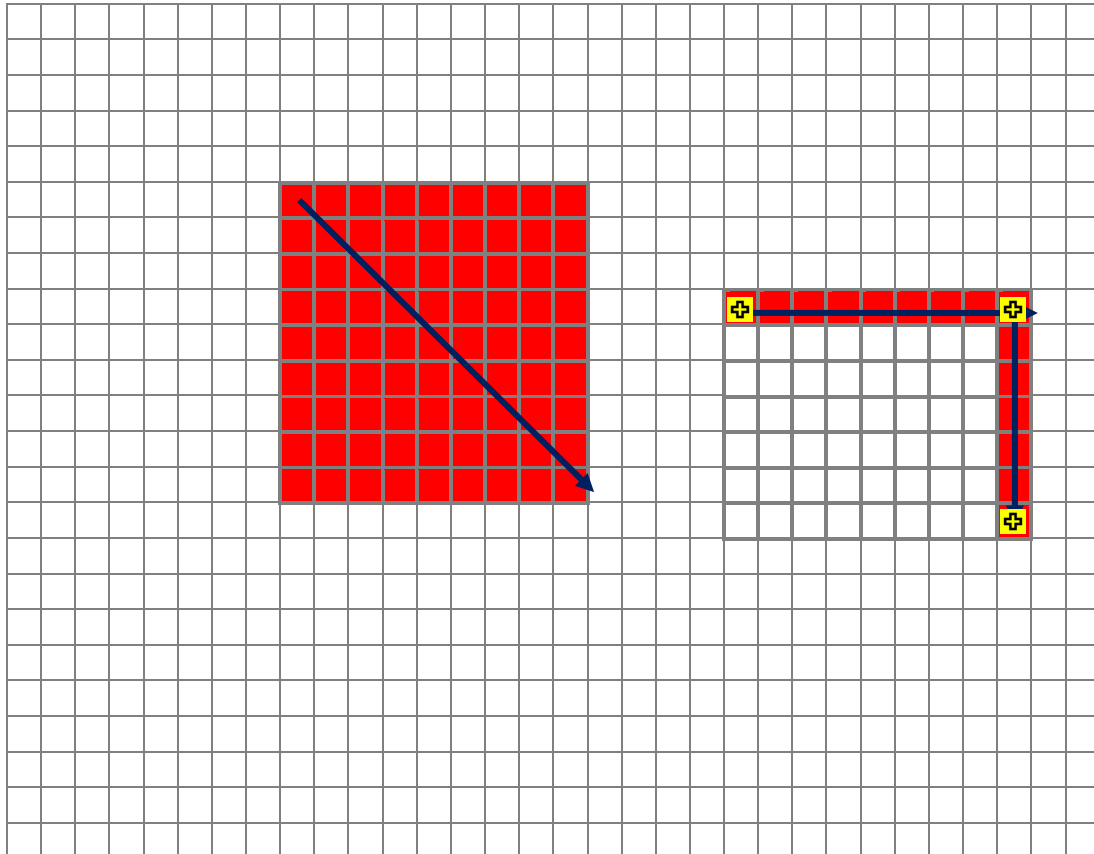

### 5-4-7. Alarm Input

You can set up the Alarm Input/Output.

Press Menu button > ◀▶ buttons, then press [ENTER]> ▲▼ buttons in channel setup mode. And then, in alarm mode, press [ENTER] > ◀▶ buttons and select whether you want to use the alarm function or not.

### 5-5. Login set

In this menu, it is possible to set the password use, change password.

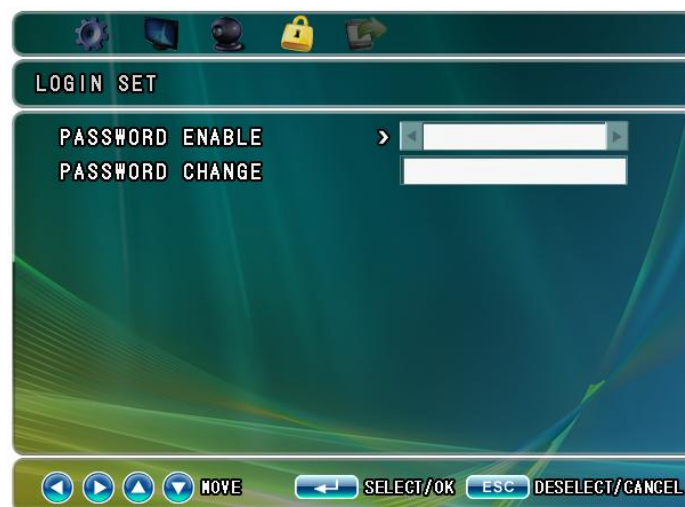



### 5-5-1. Password Enable

You can set the password you want to use.

Use this menu in case that only the authorized administrator can handle the menu setting. In case of selecting the password use mode, whenever you enter to the menu, the Login window appears and you should enter the password set. Press Menu > press ◀▶ buttons and [ENTER] in Login set > press ▲▼ buttons and [ENTER] in Password enable. Press ◀▶ buttons to select whether you want to activate or deactivate the password.

### 5-5-2. Password Change

Use this menu to change the password.

Press Menu > press ◀▶ buttons and [ENTER] in Login set > press ▲▼ buttons and [ENTER] in Password change > separate pop-up window appears.

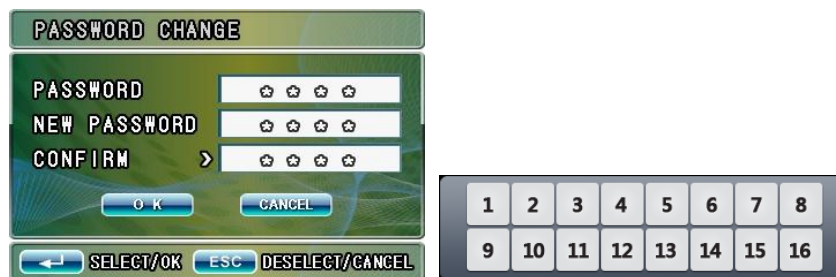

- To change the password, set "Enable" the Password Enable menu.
- Choose the 4 digits using the camera select buttons #1~4 in front of the unit.
- The following password setting pop-up windows will appear.

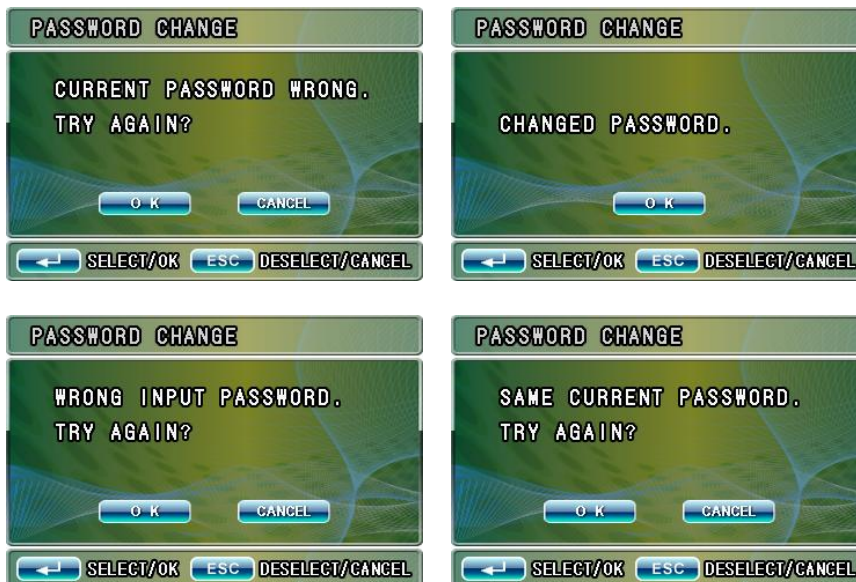

### 5-6. Exit

After setting the menu, select Exit to return to the previous display screen displayed before entering the menu.



## 6. Connection Diagram

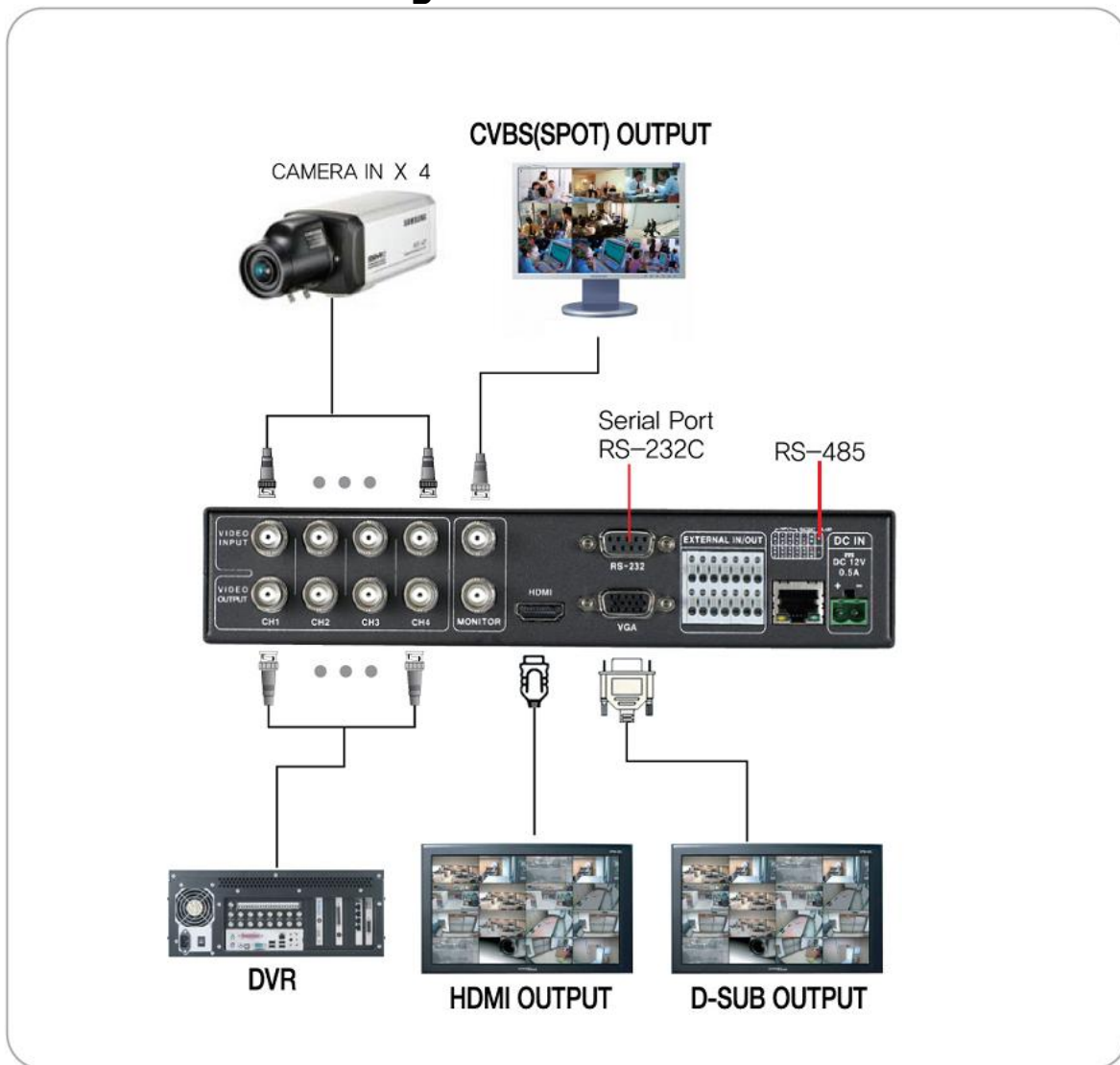

## 7. Warranty Certificate

This product has passed thorough quality control and test, and if this gets broken during normal use, we provide 12 months warranty service.

<b>Model No.</b>		
<b>Serial No.</b>		
<b>Distributor</b>		
<b>Date you purchased</b>		
<b>Place you purchased</b>		
<b>Warranty Period</b>		One (1) year from the date of purchase
<b>Purchaser</b>	<b>Name</b>	
	<b>Address</b>	

- Please check this warranty indication first.
- Please contact your distributor after checking out any defect in the products.
- The standard for repairing, replacement or reimbursement follows Customer.
- Warranty content any defect under normal use within the warranty service period we give you free repair service according to the warranty certificate.
- We charge you with the fee of parts and service despite of free warranty service period. Any breakage made without care such as:
  - Breakage or trouble made by natural disaster.
  - Breakage or trouble made by breaking the product guide or manual.
  - Breakage or trouble made by wrong power voltage or frequency.
  - When you want to reassemble for full system or replace parts within warranty service period.
  - When unauthorized person modified or made damage on the product trying to repair it.
- Please note that we don't support the breakage after warranty service period is expired. If the customer wants to get it repaired, we charge them with the fee.
- The specification is subject to change without prior notice for quality improvement.

 **SeeEyes Co.,Ltd** is the New Corporate Name of Samsung CCTV Service Co.,Ltd

**SeeEyes<sup>®</sup>**

---

 **SeeEyes Co.,Ltd**

#502~506, Sunil Technopia, 440, Sangdaewon-Dong, Jungwon-Gu,  
Sunnam-Si, Gyeonggi-Do, Korea

TEL : +82-(0)31-777-3508

FAX : +82-(0)31-777-3512

EMAIL : [overseas@sscctv.com](mailto:overseas@sscctv.com)

<http://www.sscctv.com/eng>

---