

FOR A GOOD **REASON** **GRUNDIG**

en

Owner's Manual

IP Cameras

GCI-K1503B	2 Megapixel Full HD CMOS Box IP Camera ICR
GCI-K1603B	2 Megapixel Full HD CMOS Box IP Camera Soft D/N
GCI-K1607B	2 Megapixel Full HD CMOS Box IP Camera ICR
GCI-F0505B	3 Megapixel Full HD CMOS Box IP Camera ICR WDR
GCI-G0509B	5 Megapixel Full HD CMOS Box IP Camera ICR WDR

GCI-K1503B.64.1.26.04.2013
© ASP AG



Content:			
1. Introduction	2	20. Software Version	61
2. Important Safety Instructions	2	21. Software Upgrade	61
3. Package Contents	2	22. Maintenance	62
4. Installation	2	10. Streaming Settings	64
1. Camera Overview	3	1. Video Format	64
2. System Requirements	3	2. Video Compression	66
3. Lens Mounting	4	3. Video OCX Protocol	67
4. Power Connection	4	4. Video ROI	68
5. Ethernet Cable Connection	4	5. Video Frame Rate	69
6. Alarm Application	5	6. Video Mask	70
5. Accessing the Camera	5	7. Audio (Audio and Bit Rate Settings)	71
6. Video Resolution Setup	9	11. Camera Settings	72
7. Browser-based Viewer Introduction	10	1. Exposure Setting	72
8. Home Page	11	2. White Balance Setting	73
9. System Related Settings	14	3. Picture Adjustment	74
1. Host Name & System Time Setting	14	4. Backlight Setting	75
2. Security	15	5. Digital Zoom Setting	75
3. Network	24	6. IR Function	75
4. DDNS	31	7. WDR Function	75
5. Mail	32	8. Noise Reduction	75
6. FTP	33	9. TV System Setup	76
7. HTTP	34	12. Pan/Tilt	76
8. Application (Alarm Settings)	35	1. Preset	77
9. Motion Detection	40	2. Sequence	78
10. Network Failure Detection	44	3. Pan/Tilt Control	79
11. Periodical Event	46	13. Logout	80
12. Tampering	48	14. CMS Software Introduction	80
13. Storage Management (on Camera)	50	15. Internet Security Settings	81
14. Recording (on Camera)	53	16. GRUNDIG Viewer Download Procedure	84
15. Schedule	54	17. Install UPnP Components	86
16. File Location (on PC)	55	18. Deleting the Existing GRUNDIG Viewer	88
17. Iris Adjustment	56	19. Back Focus Adjustment	90
18. View Information	56		
19. Factory Default	60		

1. Introduction

Supported with both H.264 and MJPEG standard, this GRUNDIG camera series not only features a superior Full HD resolution for streaming at 25 fps, but also supplies a D1 720p streaming. With more computing power, these IP Cameras can provide more flexibility for users and system managers.

2. Important Safety Instructions

Be sure to use only the standard adapter that is specified in the specification sheet. Using any other adapter could cause fire, electrical shock, or damage to the product. Incorrectly connecting the power supply may cause explosion, fire, electric shock, or damage to the product. Do not connect multiple products to one single adapter. Exceeding the capacity may cause abnormal heat generation or fire.

Do not place conductive objects (e.g. screwdrivers, coins or any metal items) or containers filled with water on top of the product. Doing so may cause personal injury due to fire, electric shock, or falling objects.

If any unusual smells or smoke comes out of the unit, stop using the product. In this case, immediately disconnect the power source and contact the service center. Continued use in such a condition may cause fire or electric shock.

If this product fails to operate normally, contact the nearest service center. Never disassemble or modify this product in any way. (GRUNDIG is not liable for problems caused by unauthorised modifications or attempted repair.)

To prevent fire or electric shock, do not expose the inside of this device to rain or moisture.

3. Package Contents

These parts are included:

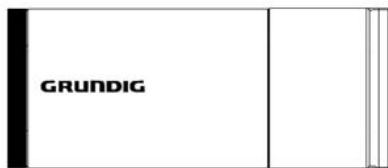

Camera



CD
(Software and Documentation)



Power Terminal Block

(not included for GCI-K1603B,
GCI-K1607B & GCI-F0505B)



Back Focus Adjuster



Quick Guide

4. Installation

Do not install the product in a location subject to high temperature (over 50°C), low temperature (below -10°C), or high humidity. Doing so may cause fire or electric shock. Keep out of direct sunlight and heat radiation sources. This may cause fire. Avoid aiming the camera directly towards extremely bright objects such as the sun, as this may damage the image sensor.

Do not install the unit in humid, dusty or sooty locations. Doing so may cause fire or electric shock. Install it in a place with good ventilation.

When installing the unit, fasten it securely and firmly. A falling unit may cause personal injury.

If you want to relocate the already installed product, be sure to turn the power off and then move or reinstall it.

4.1. Camera Overview

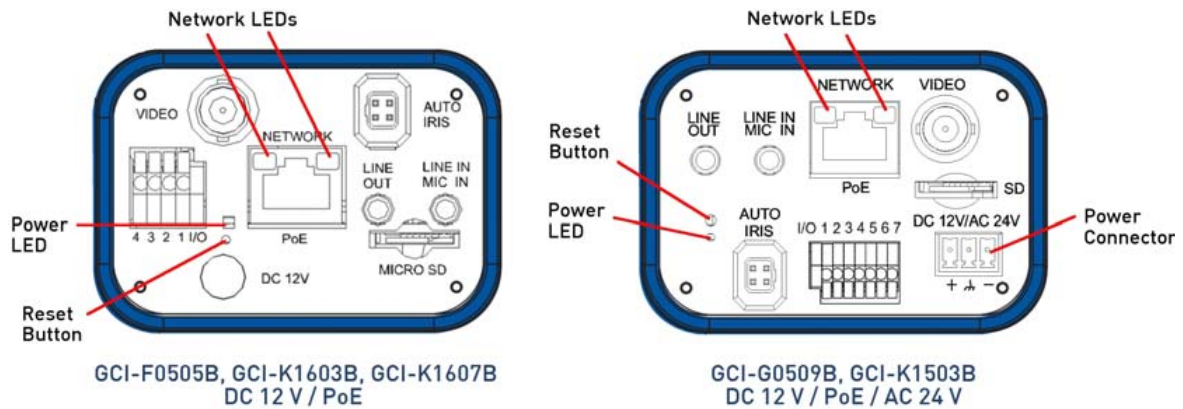

Definition	Remarks
LINE OUT & LINE IN / MIC IN	Two-way audio transmission
Power LED	Power connection indication (green light)
Reset button	Reset to factory default
AUTO IRIS connector	Auto iris lens connector
NETWORK (with PoE)	RJ-45 connector
Network LEDs	Network connection and activity indication
Alarm I/O	1 Output+ 5 GND
	2 Output- 6 D-
	3 Input+ 7 D+
	4 Input-
VIDEO (BNC connector)	For video output
Micro SD Card slot	For video recording storage
Power Connector (depending on the model)	+ AC 24V: Power-1 DC 12V: +
	⊥ Earth GND Reserved
	- AC 24V: Power-2 DC 12V: -

4.2. System Requirements

To perform the IP Camera via web browser, please ensure your PC is in good network connection, and meets the system requirements as described below.

Personal Computer :

- 1.) Intel Pentium M, 2.16 GHz or Intel Core 2 Duo, 2.0 GHz
- 2.) 2 GB RAM or more

Operating System :

Windows XP / Windows VISTA / Windows 7

Web Browser :

Microsoft Internet Explorer 6.0 or later
 Firefox
 Chrome
 Safari

Network Card :

10Base-T (10 Mbps) or 100Base-TX (100 Mbps) operation

Viewer :

ActiveX control plug-in for Microsoft IE

4.3. Lens Mounting

Lens Mounting for C/CS Mount Lens Model:

It is possible to attach all CS-Mount lenses with manual or DC controlled iris on the camera. Please remove the camera's plastic covering first and then attach the CS-Mount lens onto the camera. If you would like to use a C-Mount lens, you need a 5 mm C/CS Mount Adapter between the camera and the C-Mount lens, as shown in the illustration below.



C/CS Mount Adapter (on Camera)



Completion

4.4. Power Connection

Power Connection for GCI-K1503B and GCI-G0509B:

Please refer to section 4.1. Camera Overview for power wiring. Additionally, if using PoE, make sure Power Sourcing Equipment (PSE) is in use in the network.

Power connection for GCI-K1603B, GCI-K1607B and GCI-F0505B:

To power up the IP Camera, please plug the camera's DC 12V cable into the power outlet. Alternatively, connect the Ethernet cable to the camera's PoE port and plug the other end of the cable into a PoE switch. If you use PoE, make sure the Power Sourcing Equipment (PSE) is in use in the network.

4.5. Ethernet Cable Connection

Use of Category 5 Ethernet cable is recommended for network connection. To have the best transmission quality, the cable length shall not exceed 100 meters. Connect one end of the Ethernet cable to the RJ45 connector of the IP Camera, and the other end of the cable to the network switch or PC.

NOTE: In some cases, you may need to use an Ethernet crossover cable when connecting the IP Camera directly to the PC.

Check the status of the link indicator and the activity indicator LEDs. If the LEDs are unlit, please check the LAN connection.

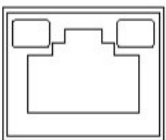

Green Link Light indicates good network connection.

Orange Activity Light flashes for network activity indication.

4.6. Alarm Application

The camera is equipped with one alarm input and one relay output for alarm application. Please refer to the alarm pin definition below for the connection of alarm devices to the IP Camera if needed.

GCI-K1603B, GCI-K1607B,
& GCI-F0505B:

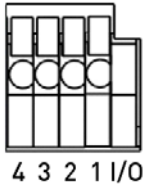

GCI-K1503B
& GCI-G0509B:

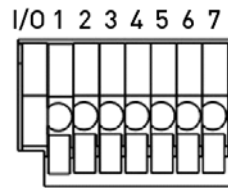

Alarm Pin Definition :

PIN 1: Output+

PIN 2: Output-

PIN 3: Input+

PIN 4: Input-

Additional for GCI-K1503B and GCI-G0509B with RS-485 Interface:

PIN 5: GND

PIN 6: D-

PIN 7: D+

5. Accessing the Camera

For initial access to the IP Camera, users can search the camera through the installer program: GRUNDIG Finder.exe, which can be found on the supplied CD.

GRUNDIG Finder Software Setup :

Step 1: Double-click on the program GRUNDIG Finder.exe (see the desktop icon below). Its window will appear as shown below. Then click on the "Find Device" button.

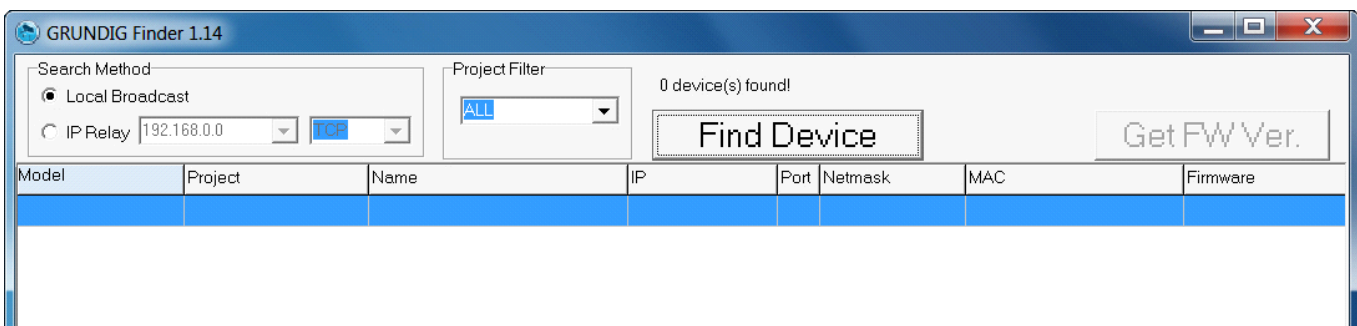

Step 2: The security alert window will pop up. Click "Unblock" to continue.



Device Search :

Step 3: Click "Find Device" again, afterwards all IP devices found will be listed on the page, as shown in the picture below. The IP Camera's default IP address is: 192.168.1.1.

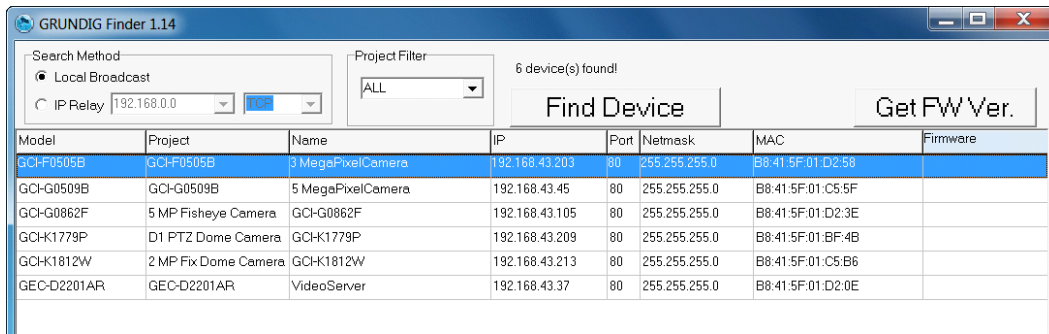

Step 4: Double-click or right-click and select "Browse" to access the camera directly via the web browser.

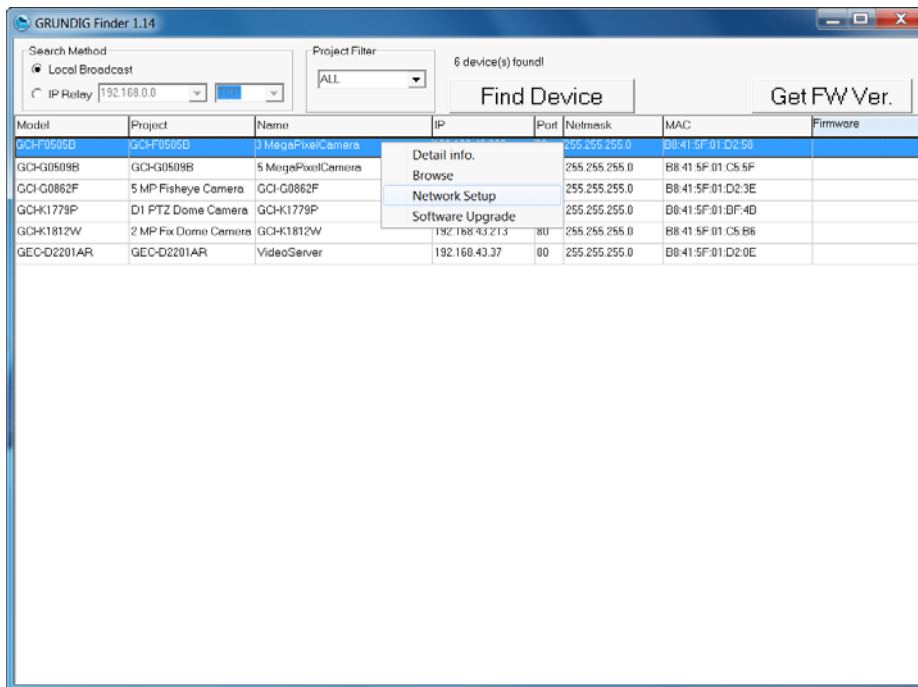

Step 5: Then the dialogue box for entering the default user name and password (as shown below) will appear for login to the IP Dome Camera.



The default login ID and password for the Administrator are:

Login ID: admin

Password: 1234

NOTE: ID and password are case sensitive.

It is strongly advised to alter the administrator's password due to security concerns. Please refer to section 9.2. Security for further details.

Additionally, users can change the IP Camera's network property, either to DHCP or Static IP, directly in the device finding list. Please refer to the following section for changing the IP Camera's network property.

Example of changing the network property of the IP Camera :

Users can directly change an IP Camera's network property, e.g. from static IP to DHCP, in the finding device list. The procedure to change the IP Camera's network property is explained below:

Step 1: In the finding device list, click on the IP Camera of which you would like to change the network property. Right-click on the selected item, and select "Network Setup". Meanwhile, record the IP Camera's MAC address for future identification.

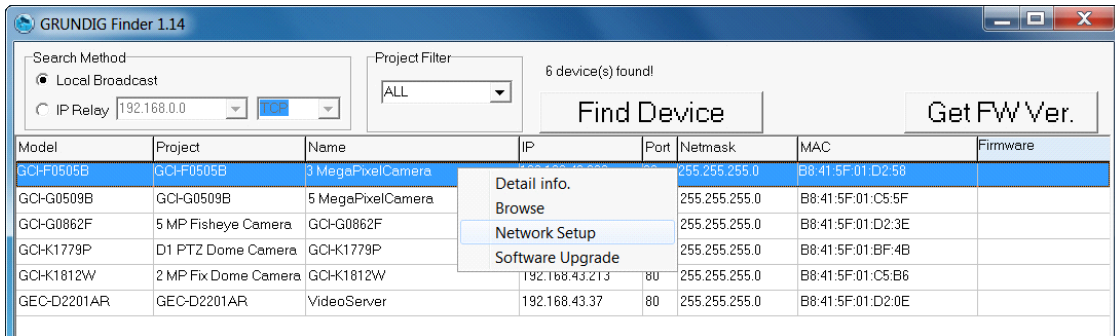

Step 2: The "Network Setup" page will come out. Select "DHCP," and click on the "Apply" button at the bottom of the page.

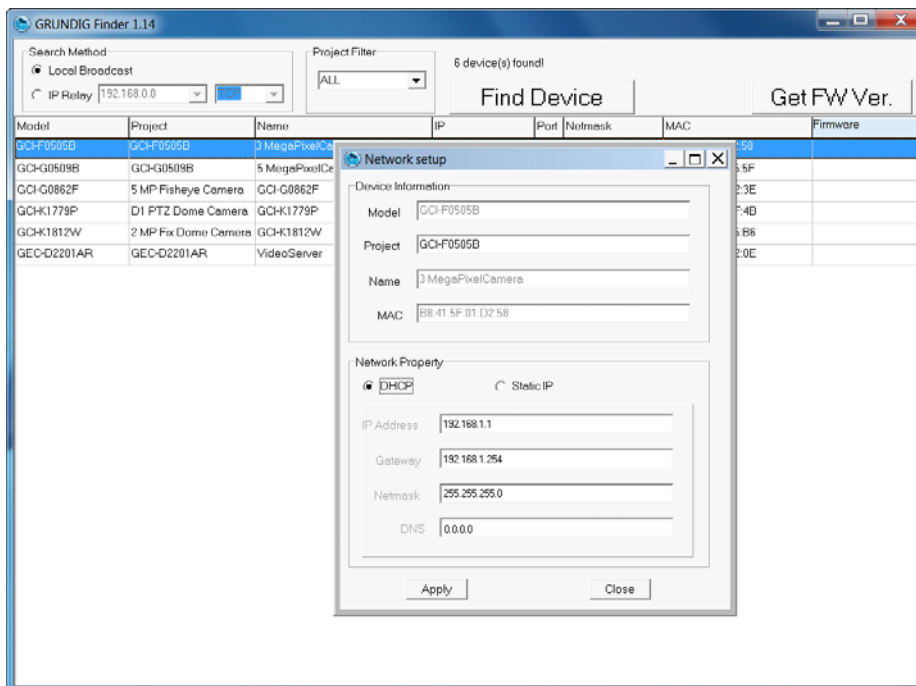

Step 3: Click on "OK" in the Note of setting the change. Wait for one minute to search again for the IP Camera.

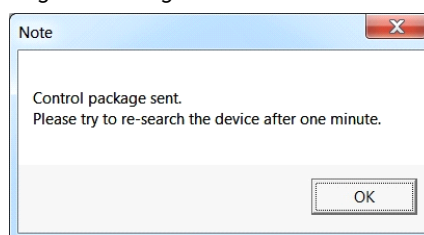

Step 4: Click on the “Find Device” button to search all the devices. Then select the IP Camera with the correct MAC address. After double-clicking on the IP Camera, the login window will appear.

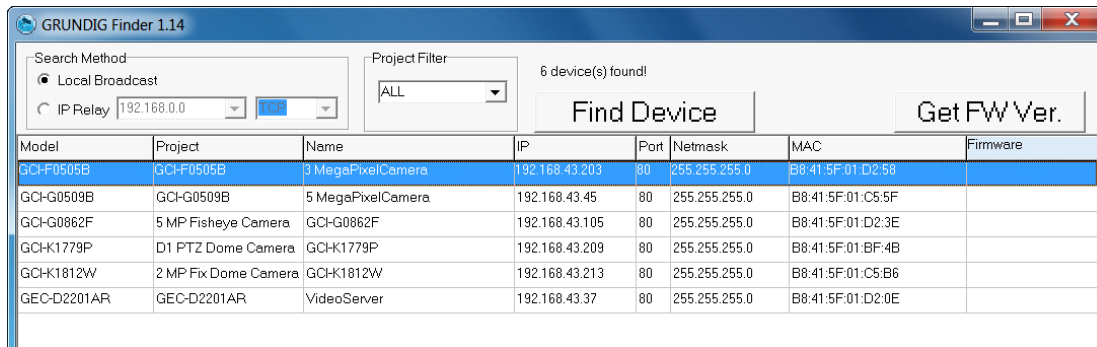

Step 5: Enter User name and Password to access the IP Camera.

Installing the GRUNDIG Viewer Software Online :

For initial access to the IP Camera, a client program, GRUNDIG Viewer, will be automatically installed to your PC when connecting to the IP Camera.

If the Web browser does not allow the GRUNDIG Viewer installation, please check the Internet security settings or ActiveX controls and plug-ins settings (see 15. Internet Security Settings) to continue the process.

The Information Bar (just below the URL bar) may come out and ask for permission to install the ActiveX Control for displaying video in browser (see the picture below). Right-click on the Information Bar and select “Install ActiveX Control...” to allow the installation.

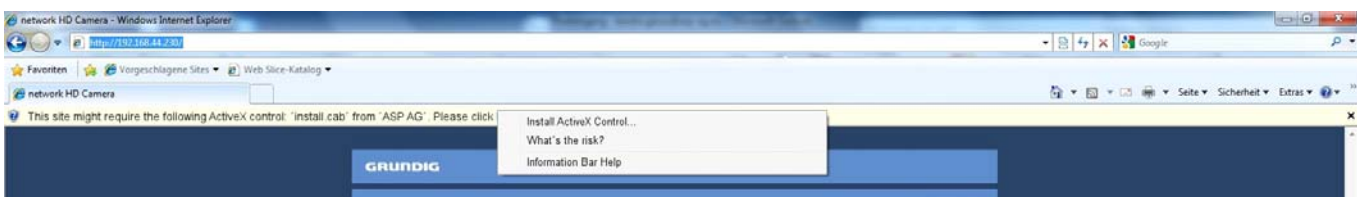

Then the security warning window will pop up. Click “Install” to carry on with the software installation.

Click on “Finish” to close the GRUNDIG Viewer window when download is finished. For the detailed software download procedure, please refer to chapter 16. GRUNDIG Viewer Download Procedure.

NOTE: If the Live Video Pane on the Home Page cannot be shown to the users who have installed the GRUNDIG Viewer on the PC previously, please refer to the procedure in chapter 18. Delete the Existing GRUNDIG Viewer.

Once logged in to the IP Camera, users will see the Home page as shown below:

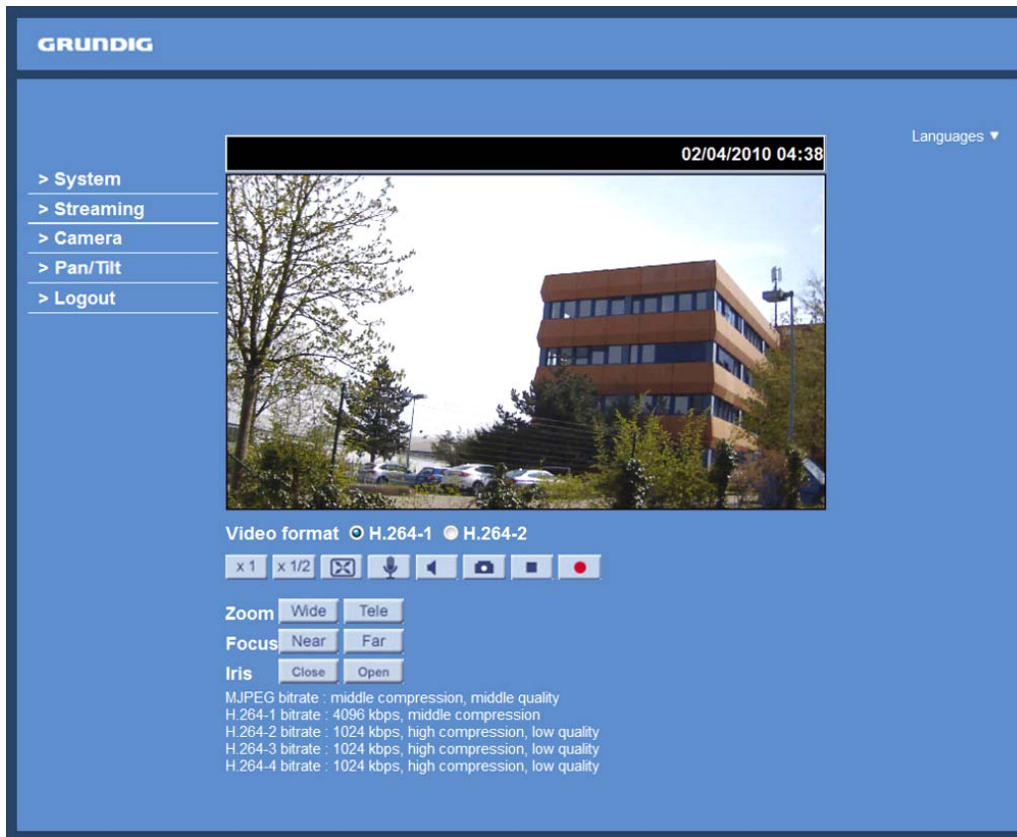

Administrator/User Privileges :

“Administrator” represents the person who can configure the IP Camera and who authorises users to have access to the camera; “User” refers to someone who has access to the camera with limited authority, i.e. to enter the Home and Camera setting pages.

Image and Focus Adjustment :

Adjust zoom and focus of the lens as necessary to produce a clear image. To set the correct angle of view and focus, you can use the BNC output on the camera. For this, please connect a PAL monitor to the BNC output.

6. Video Resolution Setup

Users can set up the Video Resolution on the Video Format page of the user-friendly browser-based configuration interface. The page “Video Format” can be found in the IP camera menu under the path: Streaming > Video Format.

Under the Video Resolution section in the menu page “Video Format”, please select your preferred resolution setting.

7. Browser-based Viewer Introduction

The picture below shows the Home page of the IP Camera's viewer window.

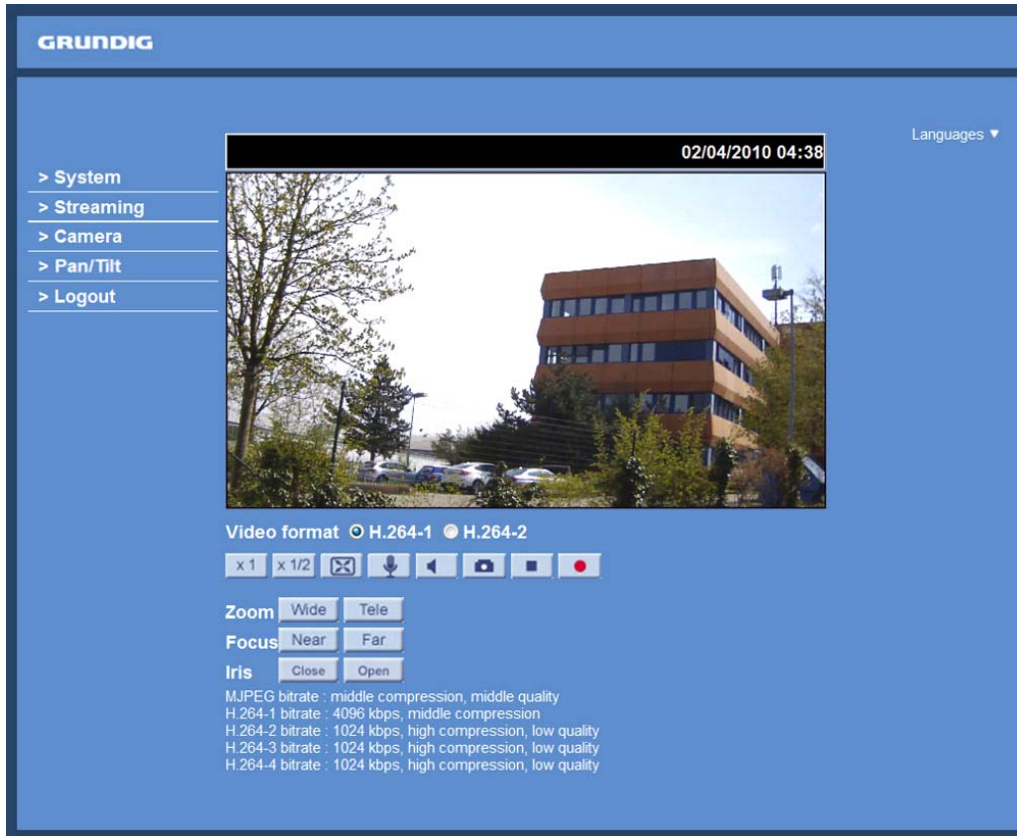

There are four or five tabs on the left (System, Streaming, Camera, Pan/Tilt in the models with RS-485 Interface: GCI-K1503B and GCI-G0509B, and Logout) and one tab on the right (Languages).

System setting :

The administrator can set host name, system time, admin password, network related settings, etc. Further details will be interpreted in chapter 9. System Related Settings.

Streaming setting :

The Administrator can configure a specific video resolution, video compression mode, video protocol, audio transmission mode, etc. in this page. Further details will be interpreted in chapter 10. Streaming Settings.

Camera setting :

Users can adjust various camera parameters. Further details will be interpreted in chapter 11. Camera Settings.

Pan/Tilt :

This menu is only available in the models GCI-K1503B and GCI-G0509B with RS-485 Interface. The users can adjust here various PTZ parameters.

Logout :

Click on this tab to re-login to the IP Camera with another user name and password. Further details will be interpreted in chapter 13. Logout.

Languages :

Please choose one of the supported languages (German, English, French, Italian or Russian).

8. Home Page

In the Home page, there are several function buttons that are specified below.

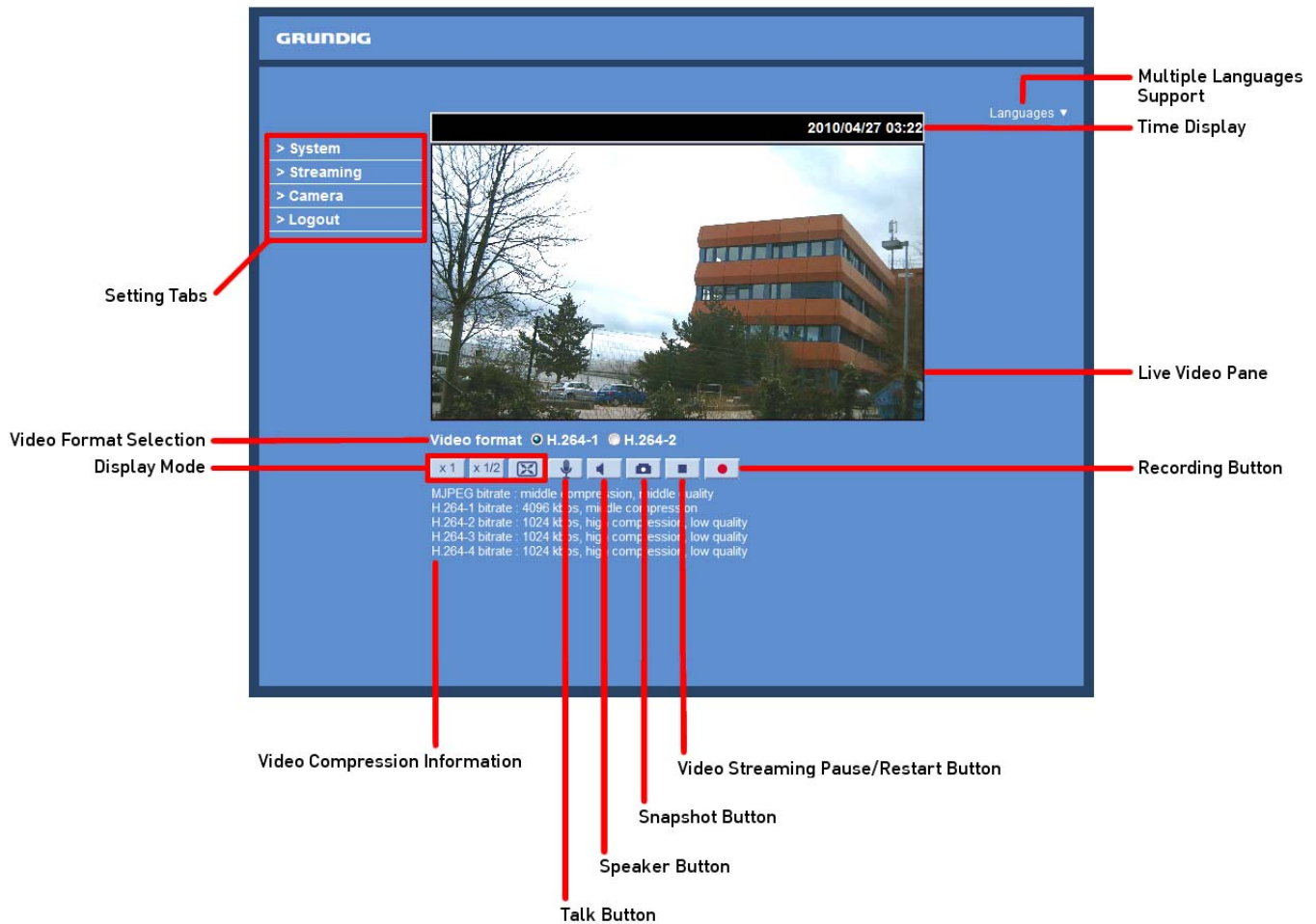

Display Mode (Screen Size Adjustment) :

The display size of the image can be adjusted to x1/2 and full screen.

Talk Button (on/off) :

Talk function allows the local site to talk to the remote site. Click on this button to switch it on/off. Please refer to section 9.2. Security: User >> Add user >> Talk/Listen for further details. This function is only open to the "User" who has been granted this privilege by the Administrator.

Please note that additional equipment will be necessary.

Speaker Button (on/off) :

Click on the Speaker button to mute/activate the audio.

Snapshot Button :

After clicking this button, the JPEG snapshots will be automatically saved in the appointed place. The default place of saving snapshots is: C:\. For changing the storage location, please refer to section 9.16. 'File Location (on PC)' for further details.

NOTE: Users with the Windows 7 operating system on their PC need to follow the following procedure to be able to use the Snapshot function. First you need to log on to your computer as an Administrator. Then please go to Windows Start menu, click with the right mouse button on your Internet Browser and select in the appearing pop-up window "Run as Administrator". Afterwards you can log in to your camera as usual (as an administrator or user).

Video Streaming Pause/Restart Button (pause/restart) :

If you click on the stop button to disable video streaming, the live video will be displayed as black. Click on the restart button to show the live video again.

Recording Button (on/off) :

When you click on this button, the recordings from the Live View will be saved to the location specified in the "File Location" page. The default storage location for the recordings is: C:/. See section 9.16. 'File Location (on PC)' for further details.

NOTE: Users with the Windows 7 operating system on their PC who want to use the Recording function, need to follow the procedure in the NOTE below the "Snapshot button" section in this chapter.

Multiple Languages Support :

Multiple languages are supported for the viewer window interface.

NOTE: The following functions are not available for the Browsers Firefox, Chrome, Safari and Opera: Full Screen Mode, Audio talk/listen, Snapshot, Playback and Recording.

The following functions are additional in the camera models GCI-K1503B and GCI-G0509B with RS-485 Interface:

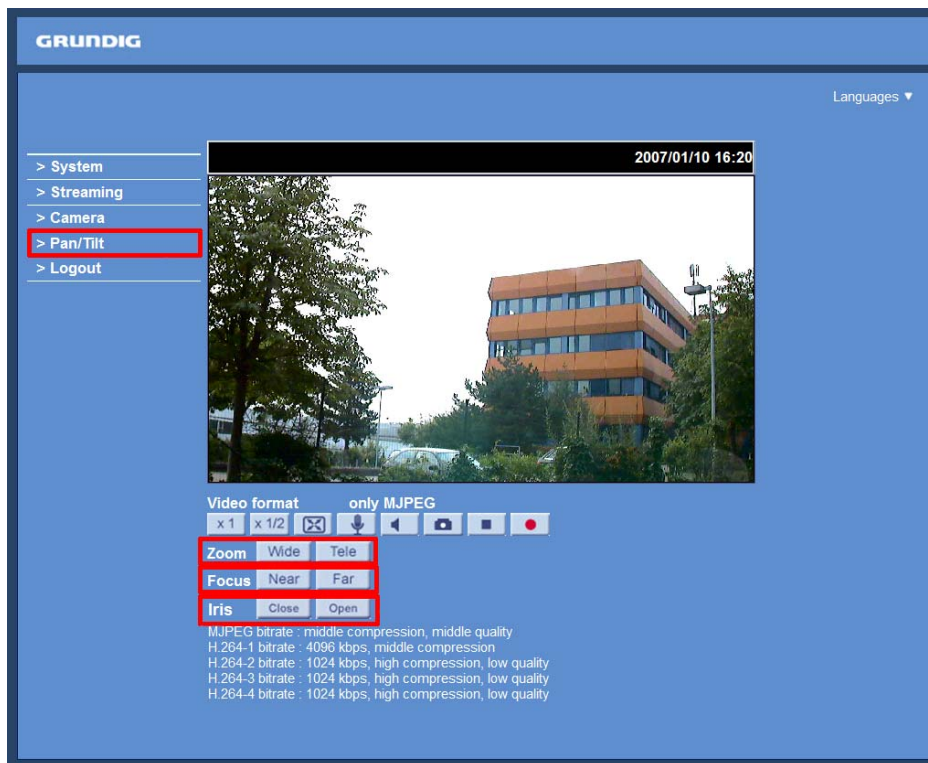

Pan/Tilt :

Here you find the settings for the Pan/Tilt function.

Pan/Tilt Control, Optical/Digital Zoom, Zoom Adjustment, Focus Adjustment and Iris Adjustment are only available if Pan/Tilt Equipment is connected to the cameras. In the following you find details about these functions.

Pan/Tilt Control :

Users can implement the pan/tilt control by first moving the cursor to the live video pane. Then click with the left mouse button, hold the click and drag the pointer in any direction.

NOTE: You can access the Pan/Tilt Control only after you selected "On" under Pan/Tilt > Pan/Tilt control.

Optical/Digital Zoom Control :

In Normal View display mode, users can implement zoom in/out by clicking in the zoom setting bar and adjusting the zoom manually or by clicking on the "Wide" / "Tele" buttons. In Full Screen mode, users can rotate the mouse wheel to zoom in/out on the image. When the camera reaches the limit of its optical range, it will automatically switch to digital zoom.

Zoom Adjustment :

Click on the buttons "Wide"/ "Tele" to control zoom in/out.

Focus Adjustment :

Users can adjust the focus manually via the "Near" and "Far" buttons.

Iris Adjustment :

Please choose <Open> to open the iris and <Close> to close the iris.

9. System Related Settings

The picture below shows all categories under the “System” tab. Each category in the left column will be explained in the following sections.

NOTE: The “System” configuration page is only accessible by the Administrator.

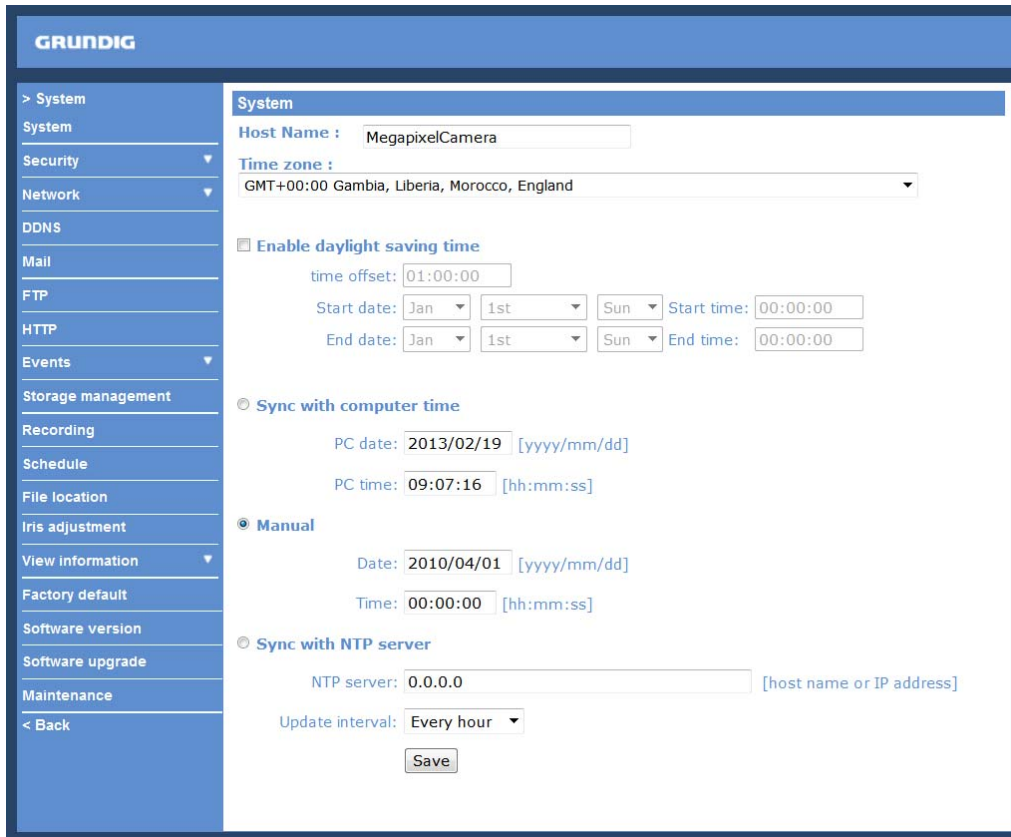

The screenshot displays the Grundig System configuration page. On the left is a navigation menu with categories: > System, System, Security, Network, DDNS, Mail, FTP, HTTP, Events, Storage management, Recording, Schedule, File location, Iris adjustment, View information, Factory default, Software version, Software upgrade, Maintenance, and < Back. The main content area is titled 'System' and contains the following settings:

- Host Name :** MegapixelCamera
- Time zone :** GMT+00:00 Gambia, Liberia, Morocco, England
- Enable daylight saving time** (checkbox):
 - time offset: 01:00:00
 - Start date: Jan 1st Sun Start time: 00:00:00
 - End date: Jan 1st Sun End time: 00:00:00
- Sync with computer time** (radio button):
 - PC date: 2013/02/19 [yyyy/mm/dd]
 - PC time: 09:07:16 [hh:mm:ss]
- Manual** (radio button):
 - Date: 2010/04/01 [yyyy/mm/dd]
 - Time: 00:00:00 [hh:mm:ss]
- Sync with NTP server** (radio button):
 - NTP server: 0.0.0.0 [host name or IP address]
 - Update interval: Every hour

A 'Save' button is located at the bottom of the configuration area.

9.1. Host Name & System Time Setting

Click on the first category <System> in the left column; the page is shown below.

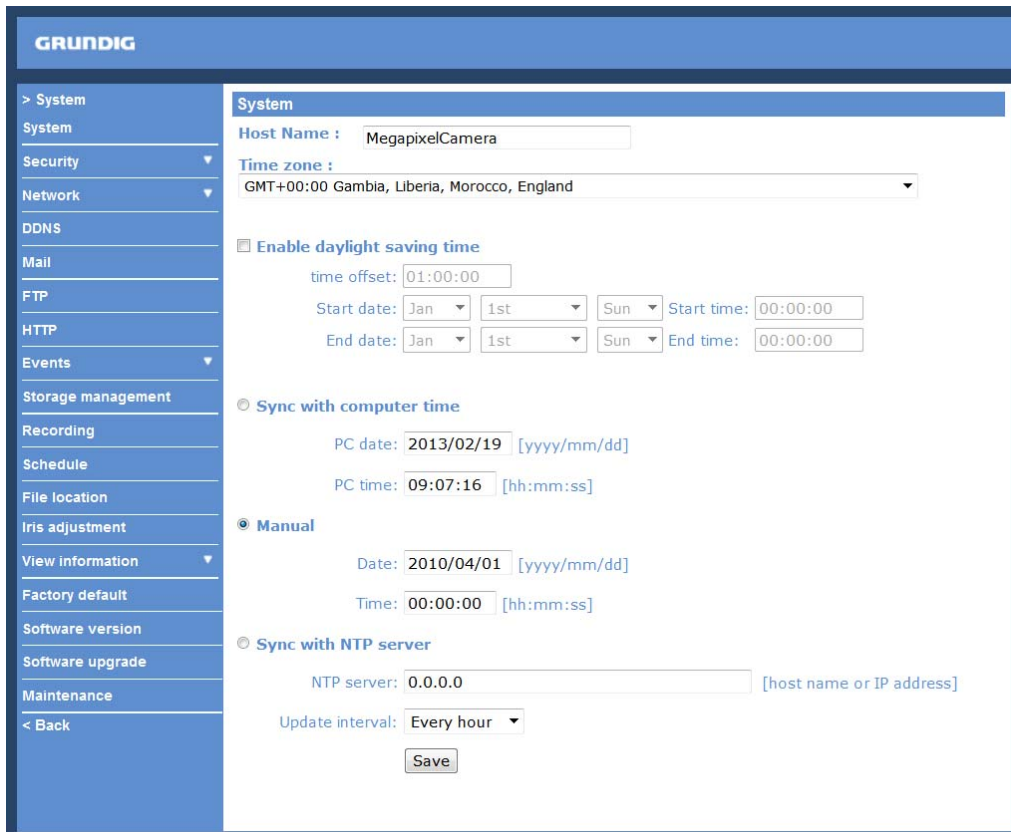

This screenshot is identical to the one above, showing the Grundig System configuration page with the same navigation menu and settings for Host Name, Time zone, Daylight saving time, Sync with computer time, Manual, and Sync with NTP server.

Host Name :

The name is for camera identification (max. 30 characters). If the alarm function (see section 9.8. 'Application (Alarm Settings)') is enabled and is set to send an alarm message by Mail/FTP, the host name entered here will be displayed in the alarm message.

Time Zone :

Select the time zone you are in from the drop-down menu.

Enable Daylight Saving Time :

To enable DST, please check the item and then specify the time offset and DST duration. The format for time offset is [hh:mm:ss]; for instance, if the amount of time offset is one hour, please enter "01:00:00" into the field.

Time format:

Choose a time format (yyyy/mm/dd or dd/mm/yyyy) from the drop-down menu.

The time format for "PC date" and "Date" under <Sync with Computer Time> and <Manual> will be changed according to the selected format.

Sync with Computer Time :

After selecting this item, the video date and time display will be synchronised with the PC.

Manual :

The Administrator can set the date, time and day manually. Entry format should be identical with the format shown next to the enter fields.

Sync with NTP server :

Network Time Protocol (NTP) is an alternative way to synchronise your camera's clock with a NTP server. Please specify the server you wish to synchronise the camera with in the enter field. Then select an update interval from the drop-down menu. For further information about NTP, please see the web site: www.ntp.org.

NOTE: Click on < Save > to confirm the new setting.

9.2. Security

When you click on the category <Security>, there will be a drop-down menu with several tabs including <User>, <HTTPS>, <IP Filter>, and <IEEE 802.1X>.

<User> :

When you click on the <User> tab under the category <Security>, the <User> page will be shown as in the picture below.

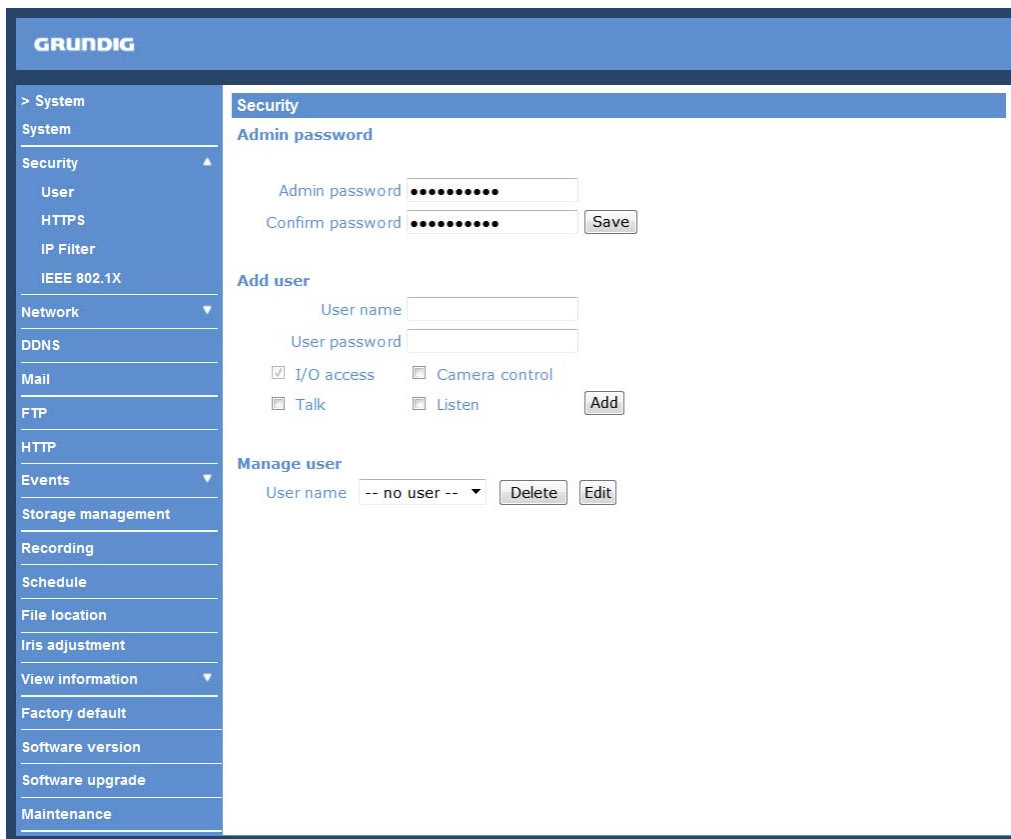

NOTE: The following characters are valid: A-Z, a-z, 0-9, !#\$%&'-.@^_~.

Admin Password :

Change the administrator's password by putting in the new password in the "Admin password" and "Confirm password" text boxes. The input characters/numbers will be displayed as dots for security purposes. After clicking <Save>, the web browser will ask the Administrator for the new password for access. The maximum length of the password is 14 digits.

Add User :

Type in the new user name and password and click <Add> to add the new user. The user name can have up to 16 characters, the password up to 14 characters. The new user will be displayed in the user name list. A maximum of 20 user accounts can be set. To each user the privileges "Camera control", "Talk" and "Listen" can be assigned.

- I/O access:

This item supports fundamental functions that enable users to view the video when accessing the camera.

- Camera control:

This item allows the specified User to change the camera's parameters on the Camera Setting page.

- Talk/Listen:

Talk and Listen functions allow the appointed user on the local site (PC site) to communicate, for instance, with the administrator on the remote site.

Manage User :

To delete a user, pull down the user list, and select the user name you wish to delete. Then click <Delete> to remove it.

To edit a user, pull down the user list and select a user name. Click <Edit> to edit the user's password and privileges.

NOTE: It is required to enter the User password and to select the functions that will be open to the user. When finished, click <Save> to modify the account authority.

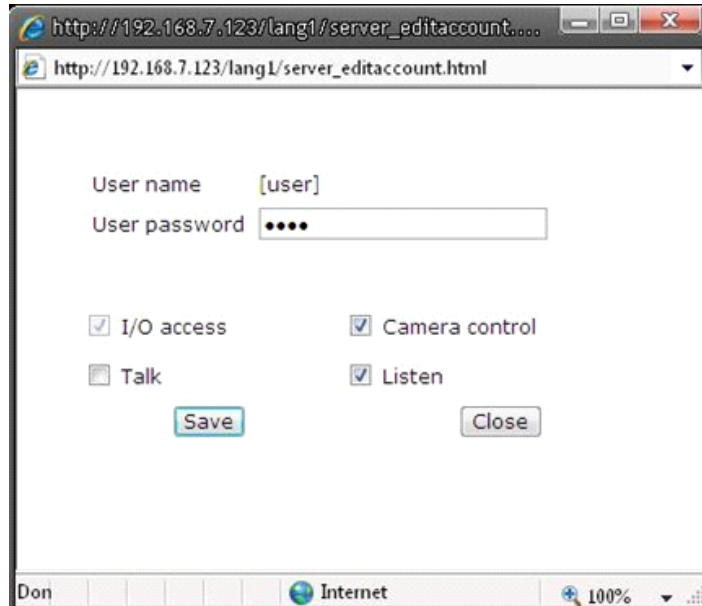

Streaming Authentication Setting :

The Network Camera provides two types of security settings for an HTTP transaction: basic and digest. Please choose the one that meets your network security requirements.

- Disable: To inactivate the function.

- Basic: In this mode, the password is sent in plain text format and there can be potential risks of the password being intercepted.

- Digest: User credentials are encrypted using an MD5 algorithm and thus provide better protection against unauthorised accesses.

<HTTPS> :

<HTTPS> allows secure connections between the IP Camera and the web browser using the <Secure Socket Layer (SSL)> or the <Transport Layer Security (TLS)>, which prevent others from snooping on your camera settings or Username/Password. It is required to install a self-signed certificate or a CA-signed certificate for implementation of <HTTPS>.

After clicking on the <HTTPS> tab, the HTTPS setting page will be shown as in the figure below.

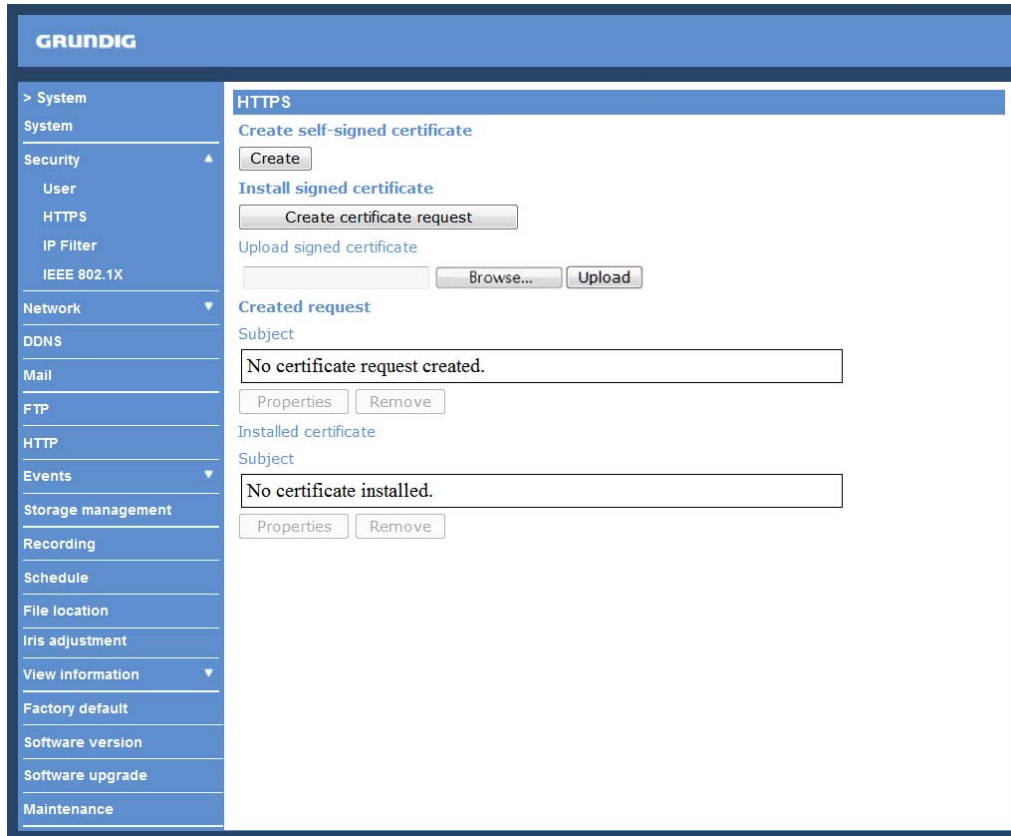

To use HTTPS on the IP Camera, a HTTPS certificate must be installed. The HTTPS certificate can be obtained by either creating and sending a certificate request to a Certificate Authority (CA) or creating a self-signed HTTPS certificate, as described below.

Create self-signed certificate :

Before a CA-issued certificate is obtained, users can create and install a self-signed certificate first.

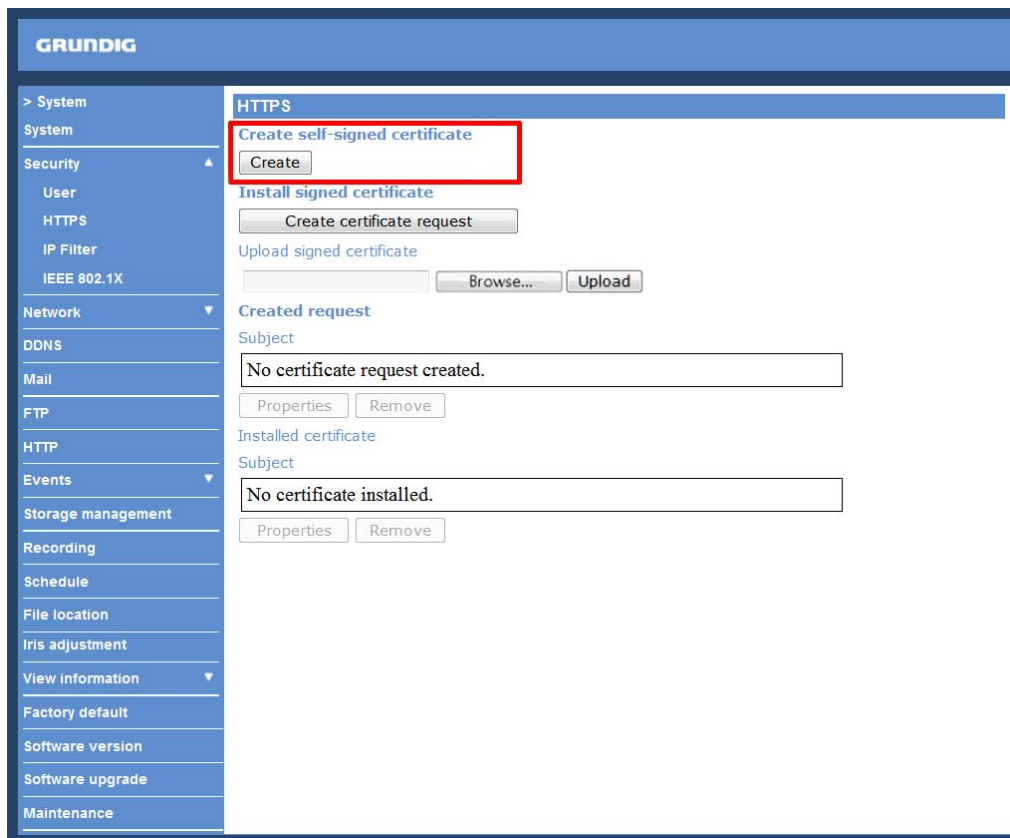

Click on the <Create> button under “Create self-signed certificate” and provide the requested information to install a self-signed certificate for the IP Camera. Please refer to the last part of this section: “Provide the Certificate Information” for more details.

NOTE: The self-signed certificate does not provide the same high level of security as when using a CA-issued certificate.

Provide the requested information in the Create Dialog. Please refer to the section “Provide the Certificate Information” for more details.

Install signed certificate :

Click on the "Create Certificate Request" button to create and submit a certificate request in order to obtain a signed certificate from the CA (Certificate Authority).

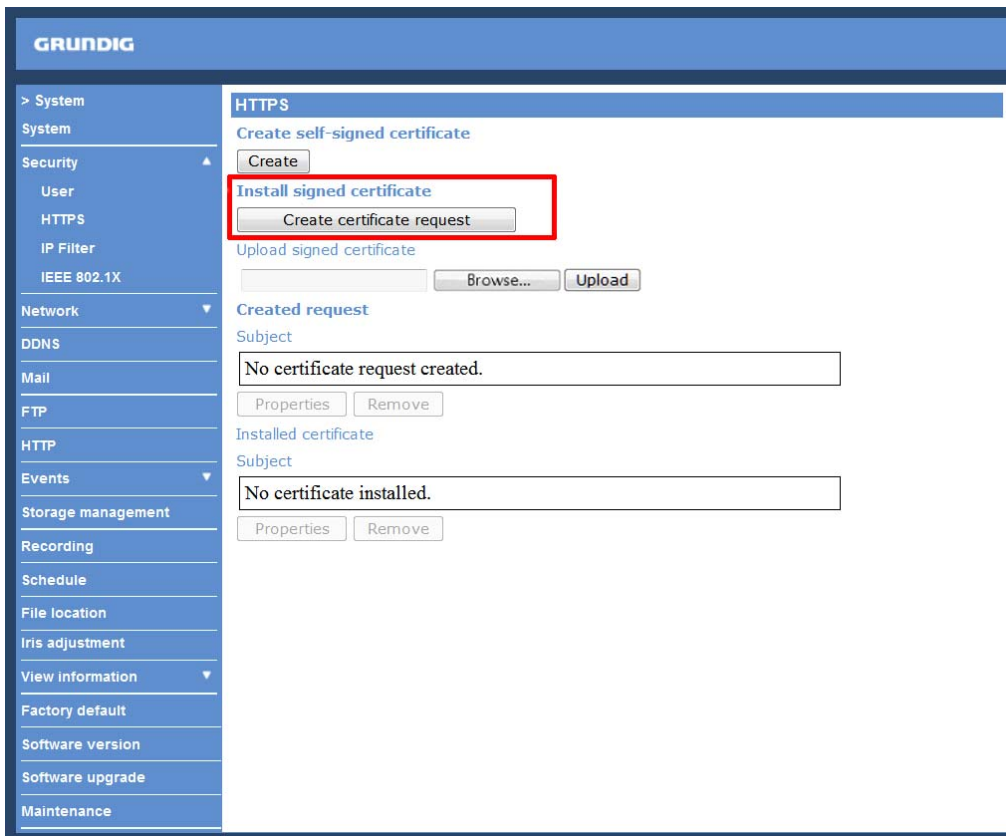

When the request is complete, the subject of the Created Request will be shown in the field. Click "Properties" below the Subject field, copy the PEM-formatted request and send it to your selected CA.

When the signed certificate is returned, install it by uploading the signed certificate.

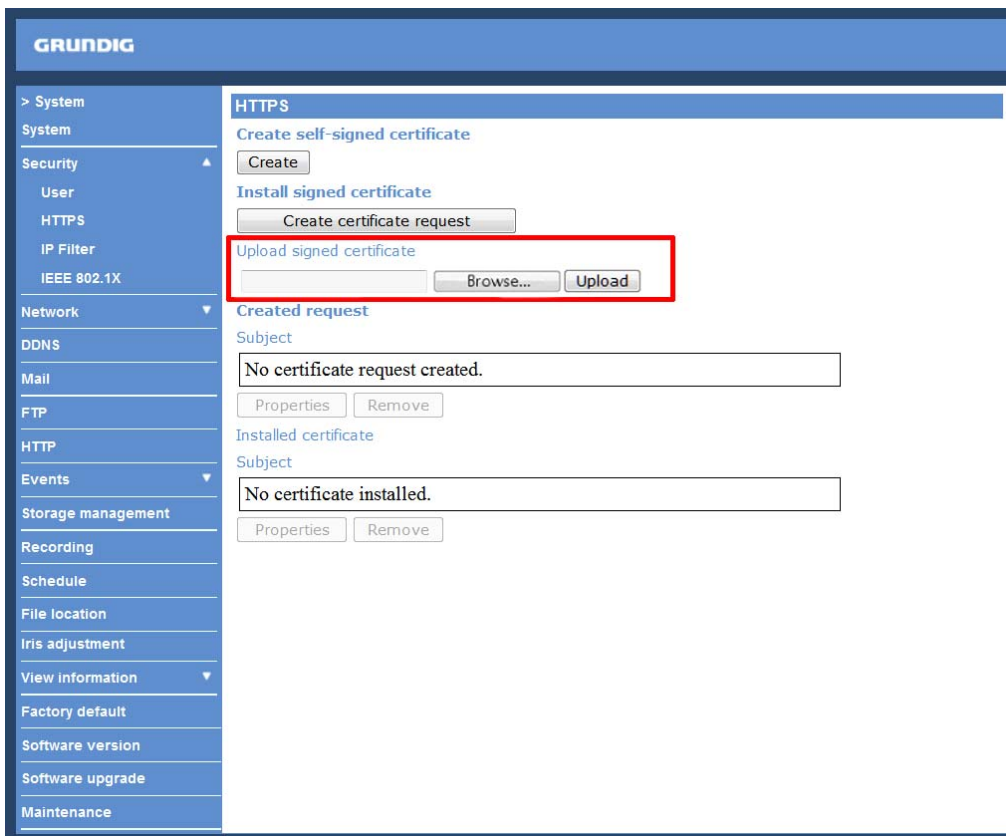

Provide the Certificate Information :

To create a Self-signed HTTPS Certificate or a Certificate Request to CA, please enter the information as requested:

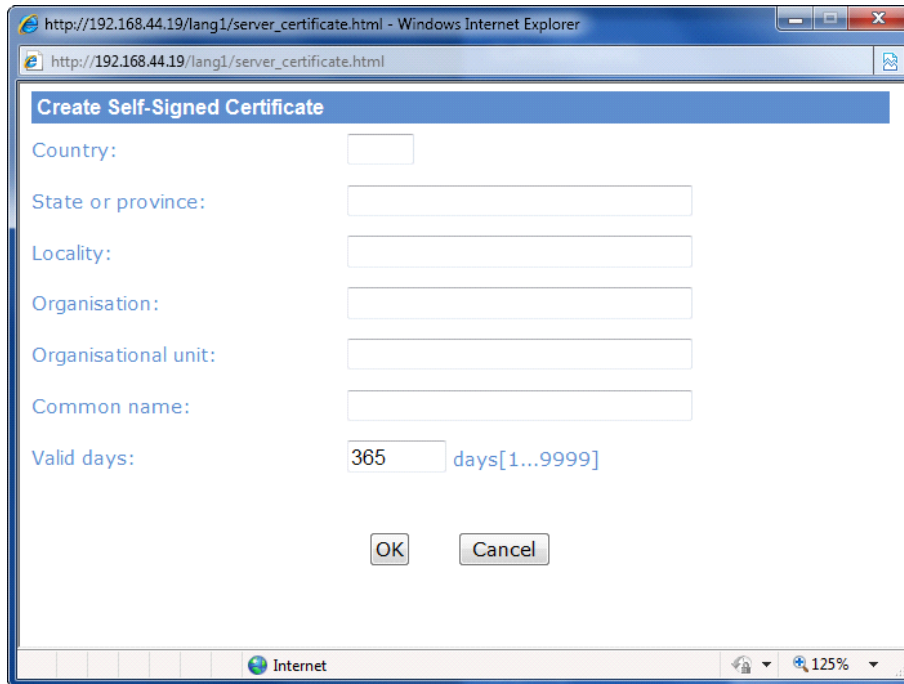

The screenshot shows a web browser window titled "http://192.168.44.19/lang1/server_certificate.html - Windows Internet Explorer". The page content is a form titled "Create Self-Signed Certificate". The form includes the following fields:

- Country:
- State or province:
- Locality:
- Organisation:
- Organisational unit:
- Common name:
- Valid days: days[1...9999]

At the bottom of the form are "OK" and "Cancel" buttons. The browser's status bar shows "Internet" and a zoom level of "125%".

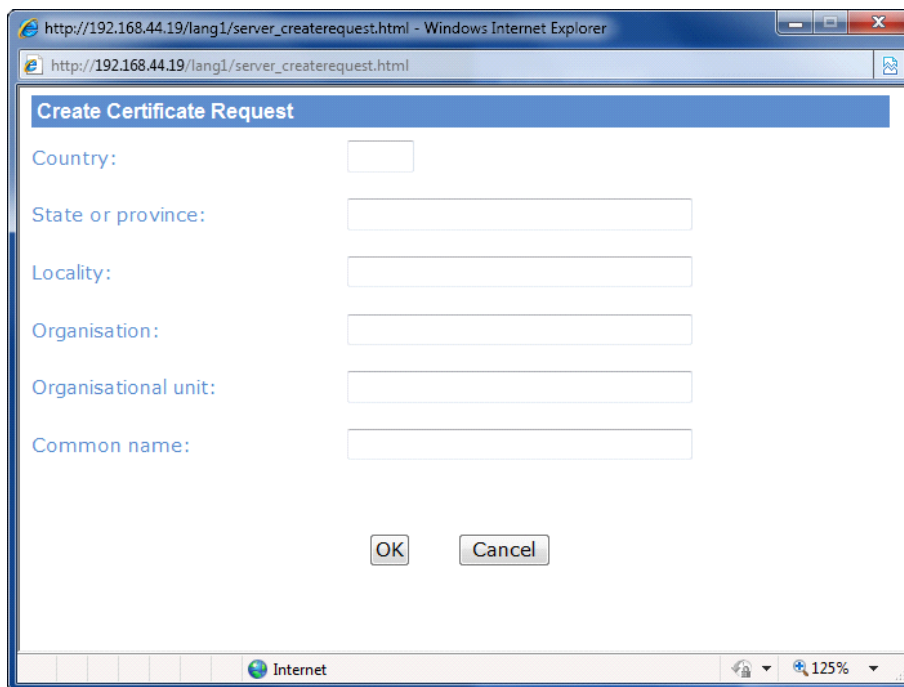

The screenshot shows a web browser window titled "http://192.168.44.19/lang1/server_createrequest.html - Windows Internet Explorer". The page content is a form titled "Create Certificate Request". The form includes the following fields:

- Country:
- State or province:
- Locality:
- Organisation:
- Organisational unit:
- Common name:

At the bottom of the form are "OK" and "Cancel" buttons. The browser's status bar shows "Internet" and a zoom level of "125%".

- Country:

Enter a 2-letter combination code to indicate the country the certificate will be used in. For instance, type in "GB" to indicate Great Britain.

- State or province:

Enter the local administrative region.

- Locality:

Enter other geographical information.

- Organisation:

Enter the name of the organisation to which the entity identified in "Common Name" belongs.

- Organisation Unit:

Enter the name of the organisational unit to which the entity identified in "Common Name" belongs.

- Common Name:

Indicate the name of the person or other entity that the certificate identifies (often used to identify the website).

- Valid days (Self-signed Certificate Only):

Enter the period in days (1~9999) to indicate the valid period of the certificate.

Click "OK" to save the Certificate Information after completing.

<IP Filter> :

When using the IP filter, access to the IP Camera can be restricted by denying/allowing specific IP addresses.

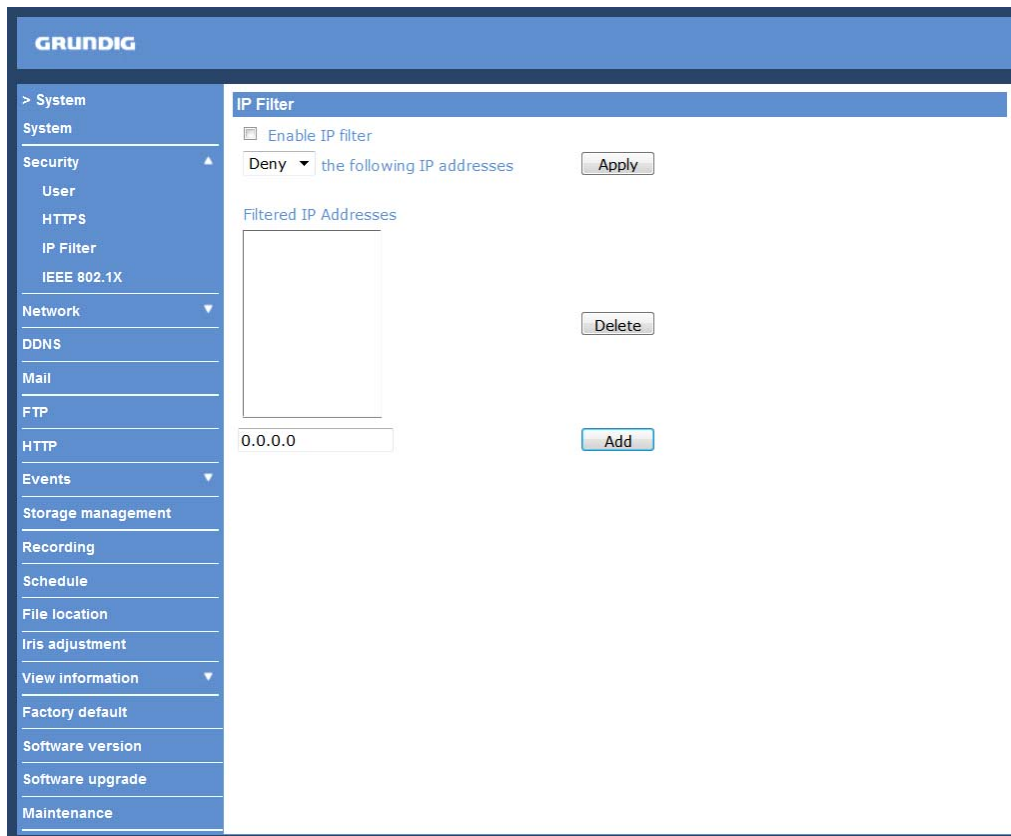

General :

- Enable IP Filter:

Check the box to enable the IP Filter function. Once enabled, access to the IP Camera will be allowed/denied for the listed IP addresses (IPv4).

Select "Allow" or "Deny" from the drop-down list and click the <Apply> button to determine the IP Filter behaviour.

- Add/Delete IP Address:

Input the IP address and click the <Add> button to add a new filtered address.

The Filtered IP Addresses list box shows the currently configured IP addresses. Up to 256 IP address entries may be specified.

To remove an IP address from the list, please select the IP and then click the <Delete> button.

<IEEE 802.1X> :

The IP Camera can access a network protected by 802.1X/EAPOL (Extensible Authentication Protocol over LAN). To do this, users need to contact the network administrator to receive certificates, user IDs and passwords.

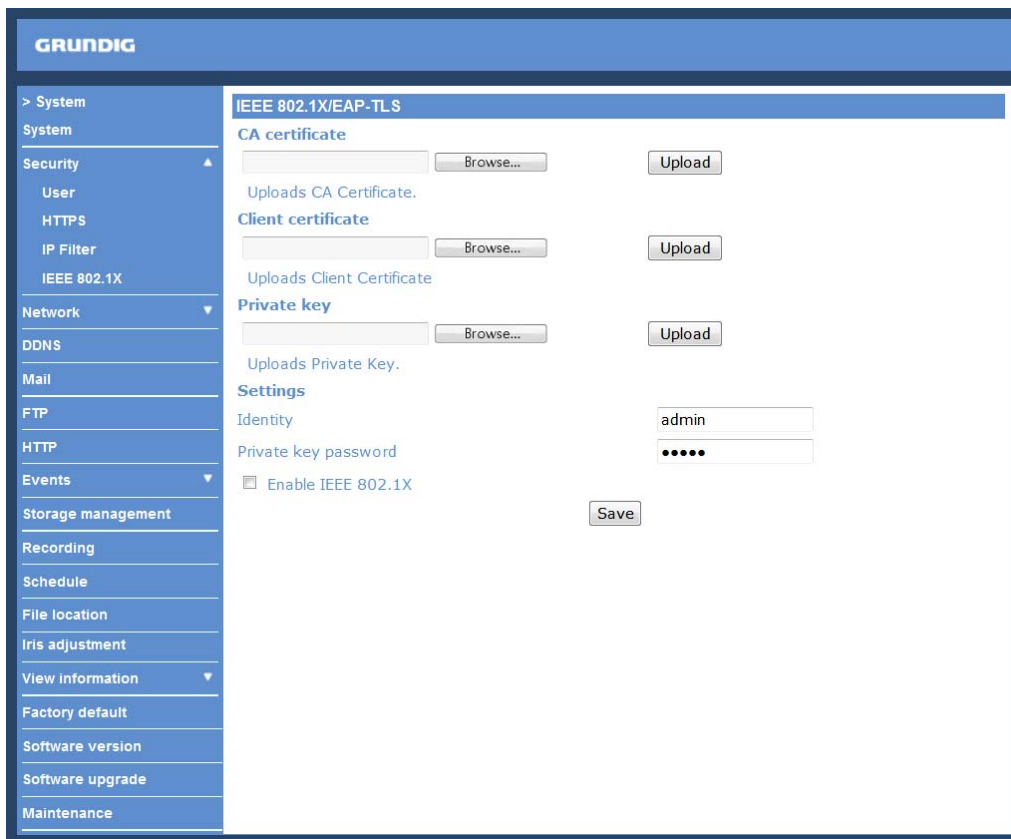

CA Certificate :

The CA certificate is created by the Certification Authority for the purpose of validating itself. Upload the certificate for checking the server's identity.

Client Certificate/Private Key :

Upload the Client Certificate and Private Key for authenticating the IP Camera itself.

Settings :

- Identity:

Enter the user identity associated with the certificate. Up to 16 characters can be used.

- Private Key Password:

Enter the password (maximum 16 characters) for your user identification.

Enable IEEE 802.1X :

Check the box to enable IEEE 802.1X.

Click "Save" to save the IEEE 802.1X/ EAP—TLS setting.

9.3. Network

When you click on the category <Network>, there will be a drop-down menu with several tabs including <Basic>, <QoS>, <SNMP>, and <UPnP>.

The screenshot shows the Grundig Network configuration interface. On the left is a navigation menu with categories: > System, System, Security, Network (expanded), DDNS, Mail, FTP, HTTP, Events, Storage management, Recording, Schedule, File location, Iris adjustment, View information, Factory default, Software version, Software upgrade, and Maintenance. The Network section is expanded to show sub-tabs: Basic, QoS, SNMP, and UPnP. The main content area is titled 'Network' and has a 'General' sub-tab selected. It contains three sections: 1. 'General' with radio buttons for 'Get IP address automatically' (selected) and 'Use fixed IP address'. Below are input fields for IP address (192.168.1.1), Subnet mask (255.255.255.0), Default gateway (0.0.0.0), Primary DNS (0.0.0.0), and Secondary DNS (0.0.0.0). 2. 'Use PPPoE' with radio button selected, and input fields for User name and Password, followed by a 'Save' button. 3. 'Advanced' with input fields for Web server port (80), RTSP port (554), MJPEG over HTTP port (8008), and HTTPS port (443), followed by a 'Save' button. 4. 'IPv6 address configuration' with a checkbox for 'Enable IPv6' (unchecked), an 'Address :' label, and a 'Save' button.

<Basic> :

Users can choose to connect to the IP Camera through a fixed or dynamic (DHCP) IP address. The IP Camera also provides PPPoE (Point-to-Point Protocol over Ethernet) support for users who connect to the network via PPPoE.

This screenshot is identical to the one above, showing the Grundig Network configuration page with the 'Basic' sub-tab selected under the 'Network' category. The configuration options and values are the same as in the previous image.

Get IP address automatically (DHCP):

The camera's default setting is "Use fixed IP address". Please refer to the previous section 6. Accessing the Camera for login with the default IP address.

If "Get IP address automatically" is selected, after the IP Camera restarts, users can search the IP address through the installer program "GRUNDIG Finder.exe", that is on the supplied CD.

NOTE: The DHCP function can only be used if you have a DHCP server in the used network.

NOTE: Please make a record of the IP Camera's MAC address, which can be found on the label of the camera, for identification in the future.

Use a fixed IP address :

To set up a static IP address, select "Use fixed IP address" and move the cursor to the IP address blank (as indicated below) and insert the new IP address, e.g. 192.168.44.230; then go to Default Gateway (explained later) and type in the appropriate setting, e.g. 192.168.44.1.

Click on "Save" to confirm the new setting.

The screenshot shows the Grundig web interface for network configuration. The left sidebar contains a menu with categories like System, Security, Network, Mail, FTP, HTTP, Events, Storage management, Recording, Schedule, File location, Iris adjustment, View information, Factory default, Software version, Software upgrade, and Maintenance. The main content area is titled 'Network' and has a 'General' sub-section. Under 'General', there are two radio button options: 'Get IP address automatically' (selected) and 'Use fixed IP address'. The 'Use fixed IP address' option is expanded to show input fields for 'IP address' (192.168.44.230), 'Subnet mask' (255.255.255.0), 'Default gateway' (192.168.44.1), 'Primary DNS' (0.0.0.0), and 'Secondary DNS' (0.0.0.0). Below these are fields for 'User name' and 'Password' for PPPoE, and a 'Save' button. The 'Advanced' section includes 'Web server port' (80), 'RTSP port' (554), 'MJPEG over HTTP port' (8008), and 'HTTPS port' (443), with a 'Save' button. The 'IPv6 address configuration' section has a checkbox for 'Enable IPv6' and an 'Address' field with a 'Save' button.

When using a static IP address to login to the IP Camera, users can access it either through the "GRUNDIG Finder" software (see 6. Accessing the Camera) or input the IP address in the URL bar and click on "Enter".

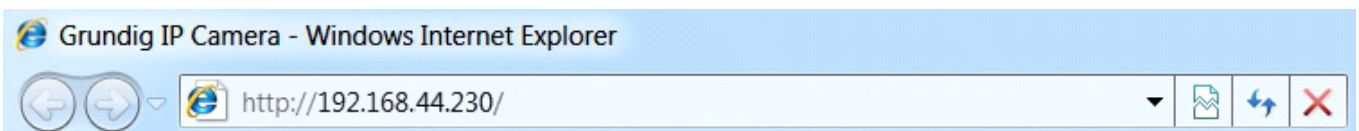

- IP address:

This is necessary for network identification.

- Subnet mask:

It is used to determine if the destination is in the same subnet. The default value is "255.255.255.0".

- Default gateway:

This is the gateway used to forward frames to destinations in different subnets. An invalid gateway setting will fail in the transmission to destinations in different subnets.

- Primary DNS:

Primary DNS is the primary domain name server that translates hostnames into IP addresses.

- Secondary DNS:

Secondary DNS is a secondary domain name server that backs up the primary DNS.

Use PPPoE :

The PPPoE users need to enter the PPPoE Username and Password into the fields, and need to click on the "Save" button to complete the setting.

Advanced :

- Web Server port:

The default web server port is 80. Once the port is changed, all users must be informed about the change for the connection to be successful. For instance, when the Administrator changes the HTTP port of the IP Camera which has the IP address "192.168.0.100" from 80 to 8080, the users must type in in the web browser "http://192.168.0.100:8080" instead of "http://192.168.0.100".

- RTSP port:

The default setting of the RTSP Port is 554; the setting range is from 1024 to 65535.

- MJPEG over HTTP port:

The default setting of the MJPEG over HTTP Port is 8008; the setting range is from 1024 to 65535.

- HTTPS port:

The default setting of the HTTPS Port is 443; the setting range is from 1024 to 65535.

NOTE: Be aware to assign a different port number for each separate service mentioned above.

IPv6 Address Configuration :

With IPv6 support, users can use the corresponding IPv6 address for browsing. Enable IPv6 by checking the box and click "Save" to complete the setting.

MAC address :

This is the MAC number of this camera.

<QoS> (Quality of Service) :

QoS allows providing differentiated service levels for different types of traffic packets which guarantees delivery of priority services especially when network congestion occurs. Adapting the Differentiated Services (DiffServ) model, traffic flows are classified and marked with DSCP (DiffServ Codepoint) values, and thus receive the corresponding forwarding treatment from DiffServ capable routers.

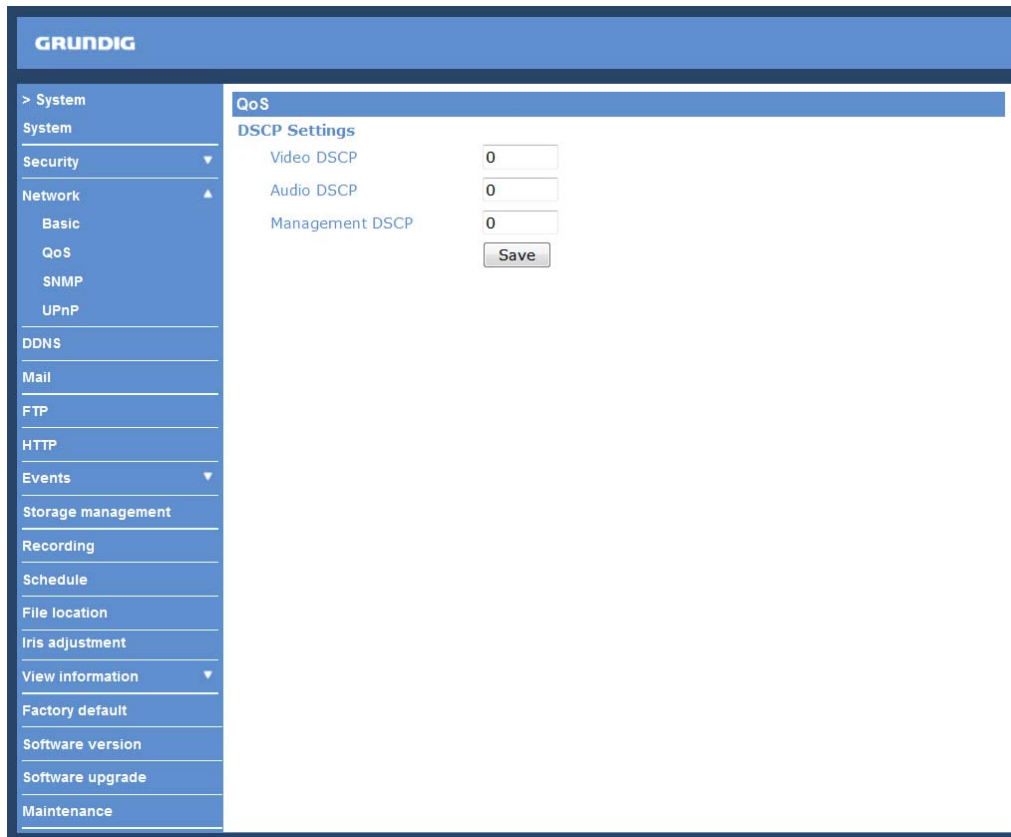

DSCP Settings :

The DSCP value range is from 0 to 63. The default DSCP value is 0, which means that DSCP is disabled.

The IP Camera uses the following QoS Classes: Video, Audio and Management.

- Video DSCP:

This class consists of applications such as MJPEG over HTTP, RTP/RTSP and RTSP/HTTP.

- Audio DSCP:

This setting is only available for the IP Cameras which support audio.

- Management DSCP:

This class consists of the HTTP traffic: Web browsing.

Click the "Save" button to complete the setting.

NOTE: To enable this function, please make sure the switches/routers in the network support QoS.

<SNMP> (Simple Network Management Protocol) :

With Simple Network Management Protocol (SNMP) support, the IP Camera can be monitored and managed remotely by the network management system.

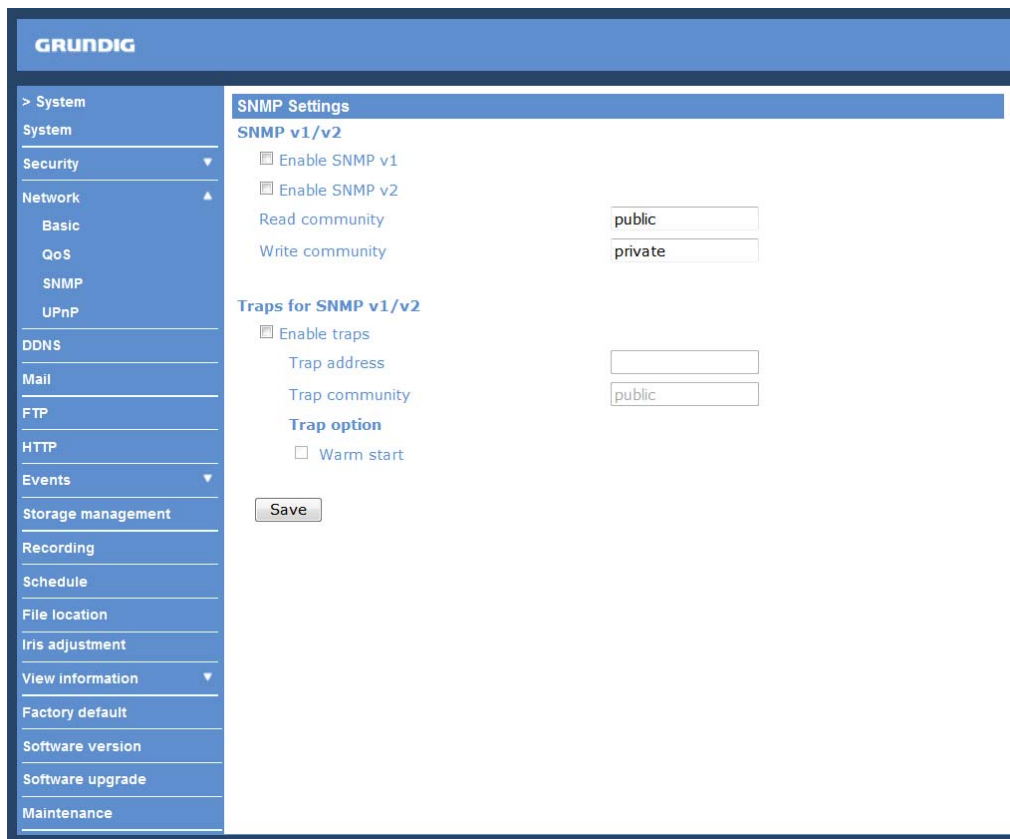

SNMP v1/v2 :

- Enable SNMP:

Select the version of SNMP to use by checking the corresponding box.

- Read Community:

Specify the community name which has read-only access to all supported SNMP objects. The default value is "public".

- Write Community:

Specify the community name which has read/write access to all supported SNMP objects (except read-only objects). The default value is "private".

SNMP v3 :

This option contains cryptographic security, a higher security level, which allows users to set the Authentication password and the Encryption password.

- Enable SNMP v3: Check the corresponding box to activate SNMP v3.

- Initial User Password (=Security Name): The community name set on NMS(Network-management station). The maximum length of the string is 32 alphanumeric characters.

- Authentication type: Select MD5 or SHA as the authentication method.

- Authentication password: Enter the password for authentication (at least 8 characters).

- Encryption type: Select DES or AES as the encryption method.

- Encryption password: Enter a password for encryption (at least 8 characters).

Traps for SNMP v1/v2/v3 :

Traps are used by the IP Camera to send messages to a management system about important events or status changes.

- Enable Traps:

Check the box to activate trap reporting.

- Trap address:

Enter the IP address of the management server.

- Trap community:

Enter the community to use when sending a trap message to the management system.

Trap option :

- Warm start:

A Warm start SNMP trap signifies that the SNMP device, i.e. the IP Camera, performs a software reload.

Click the "Save" button to complete the setting.

<UPnP> :

The screenshot displays the Grundig web interface for configuring UPnP settings. The interface is divided into a left-hand navigation menu and a main content area. The navigation menu includes categories such as System, Security, Network, DDNS, Mail, FTP, HTTP, Events, Storage Management, Recording, Schedule, File Location, Iris Adjustment, View Information, Factory Default, Software Version, Software Upgrade, and Maintenance. The main content area is titled 'UPnP' and contains the following settings:

- UPnP Setting**
- Enable UPnP
- Enable UPnP port forwarding
- Friendly name: GCI-K1603B
- Save button

UPnP Setting :

- Enable UPnP:

When UPnP is enabled, whenever the IP Camera is presented to LAN, the icon of the connected IP Cameras will appear in My Network Places to allow for direct access as shown below.

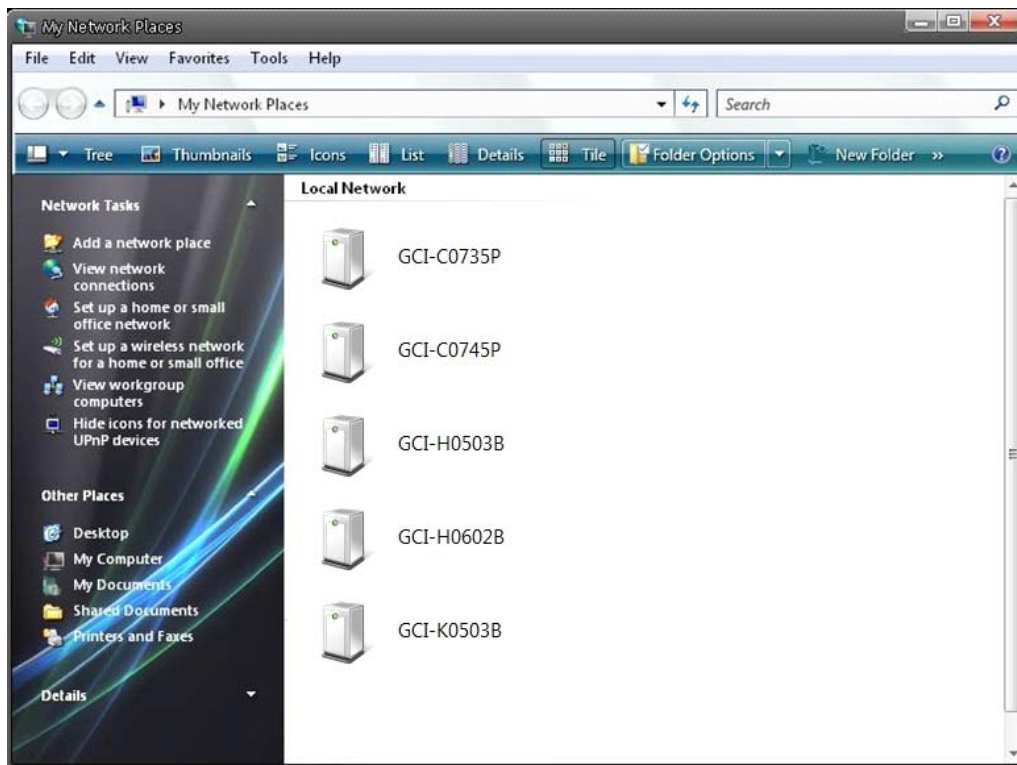

NOTE: To enable this function, please make sure the UPnP component is installed on your computer. Please refer to chapter 17. Install UPnP Components for UPnP component installation procedure.

- Enable UPnP port forwarding:

When UPnP port forwarding is enabled, the IP Camera is allowed to open the web server port on the router automatically.

NOTE: To enable this function, please make sure that your router supports UPnP and is activated.

- Friendly name:

Set the name of the IP Camera for identification.

9.4. DDNS

The Dynamic Domain Name System (DDNS) allows a host name to be constantly synchronised with a dynamic IP address. In other words, it allows those using a dynamic IP address to be associated to a static domain name so that others can connect to it through this name.

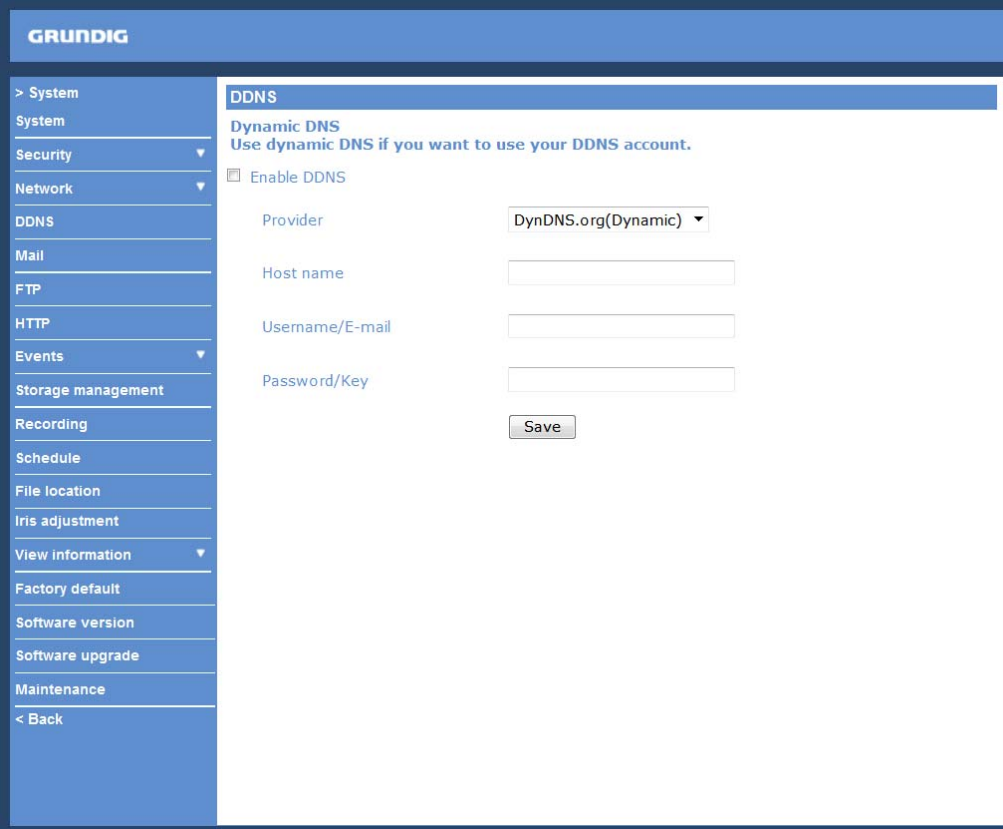

Enable DDNS :

Check the item to enable DDNS.

Provider :

Select one DDNS host from the provider list.

Host name :

Enter the registered domain name in the field.

Username/E-mail :

Enter the user name or e-mail required by the DDNS provider for authentication.

Password/Key :

Enter the password or key required by the DDNS provider for authentication.

9.5. Mail

The Administrator can set up the sending of an e-mail via Simple Mail Transfer Protocol (SMTP) when an event is triggered. SMTP is a protocol for sending e-mail messages from server to server. SMTP is a relatively simple, text-based protocol, where one or more recipients of a message are specified and to whom the message text is transferred.

The configuration page is shown below:

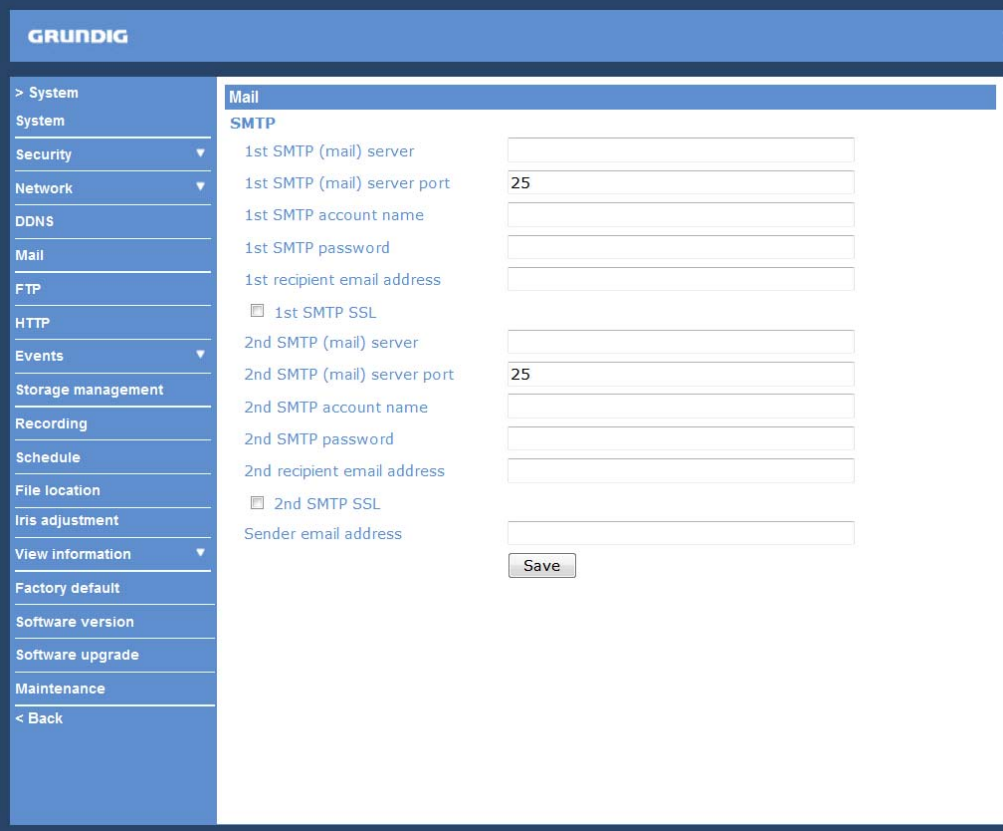

The screenshot shows the Grundig web interface for configuring mail settings. On the left is a navigation menu with categories like System, Security, Network, DDNS, Mail, FTP, HTTP, Events, Storage management, Recording, Schedule, File location, Iris adjustment, View information, Factory default, Software version, Software upgrade, and Maintenance. The main content area is titled 'Mail' and contains an 'SMTP' section. It lists two SMTP servers. The first server has fields for '1st SMTP (mail) server', '1st SMTP (mail) server port' (set to 25), '1st SMTP account name', '1st SMTP password', and '1st recipient email address'. There is a checkbox for '1st SMTP SSL'. The second server has fields for '2nd SMTP (mail) server', '2nd SMTP (mail) server port' (set to 25), '2nd SMTP account name', '2nd SMTP password', and '2nd recipient email address'. There is a checkbox for '2nd SMTP SSL'. At the bottom of the SMTP section is a 'Sender email address' field and a 'Save' button.

Two sets of SMTP can be configured. Each set includes the SMTP Server, Server Port, Account Name, Password and E-mail Address settings. Check the box "SMTP SSL" to send emails via encrypted transmission. Concerning the SMTP server, contact your network service provider for more specific information.

Click the "Save" button to save the changes.

9.6. FTP

The Administrator can set the sending of alarm messages to a specific File Transfer Protocol (FTP) site when an event is detected. Users can assign an alarm message to up to two FTP sites. The FTP setting page is shown below. Enter the FTP details, which include server, server port, user name, password and remote folder, into the fields. Check the box "passive mode" to be connected to the FTP server by passively receiving the FTP server's IP address through a dynamic port. Alternatively, uncheck the box to directly connect with the FTP server via active mode.

Click "Save" when the setting is finished.

The screenshot shows the Grundig FTP configuration interface. It features a left-hand navigation menu and a main configuration area. The main area is titled "FTP" and contains two identical sections for configuring the "1st FTP server" and "2nd FTP server". Each section includes input fields for the server address, port (pre-filled with "21"), user name, password, and remote folder. There are checkboxes for "1st FTP passive mode" and "2nd FTP passive mode". Below each section is a "Test" button. At the bottom of the form is a "Save" button.

9.7. HTTP

A HTTP Notification server can listen for notification messages from IP Cameras by triggered events. The HTTP setting page is shown below. Enter the HTTP details, which include the server name (for instance, http://192.168.1.1/admin.php), user name, and password into the fields. <Alarm> triggered and <Motion Detection> notifications can then be sent to the specified <HTTP> server.

Click "Save" when the setting is finished.

The screenshot shows the Grundig web interface for configuring HTTP notifications. The left sidebar contains a menu with the following items: > System, System, Security, Network, DDNS, Mail, FTP, HTTP, Events, Storage management, Recording, Schedule, File location, Iris adjustment, View information, Factory default, Software version, Software upgrade, Maintenance, and < Back. The main content area is titled 'HTTP' and contains the following fields: '1st HTTP server', '1st HTTP user name', '1st HTTP password', '2nd HTTP server', '2nd HTTP user name', and '2nd HTTP password'. A 'Save' button is located at the bottom right of the form area.

Please also refer to: 9.8. Application (Alarm Settings): Send HTTP notification / 9.9. Motion Detection for HTTP Notification settings.

9.8. Application (Alarm Settings)

The IP Camera is equipped with one alarm input and one relay output for cooperation with the alarm system to catch event images. Please refer to the alarm pin definition below to connect alarm devices to the IP Camera if needed. The alarm configuration page is also shown below.

PIN 1: Output+
 PIN 2: Output-
 PIN 3: Input+
 PIN 4: Input-

Additional for GCI-K1503B and GCI-G0509B with RS-485 Interface:

PIN 5: GND
 PIN 6: D-
 PIN 7: D+

**GCI-K1603B, GCI-K1607B,
 & GCI-F0505B:**

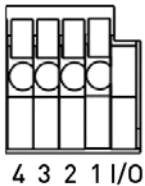

**GCI-K1503B
 & GCI-G0509B:**

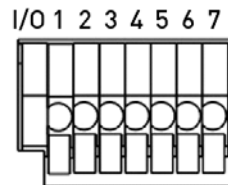

Alarm Switch :

The default setting for the Alarm Switch function is <Off>. Enable this function by selecting <On>. Users can also activate the function according to the schedule previously set in the <Schedule> setting page. Select <By schedule> and click <Please select...> to choose the desired schedule from the drop-down menu.

Alarm Type :

Select an alarm type, "Normal close" or "Normal open", that corresponds with the alarm application.

Alarm Output :

Define the alarm output signal as "high" or "low" for the normal alarm output status according to the current alarm application.

Triggered Action (Multi-option) :

The Administrator can specify alarm actions that will take place when the alarm is triggered. All options are listed as follows:

- Enable Alarm Output:

Select this item to enable alarm relay output.

- IR Cut Filter:

If you select this item, the camera's IR cut filter (ICR) will be removed (on) or blocked (off) when the alarm input is triggered.

NOTE: The IR Function (Refer to IR Function) cannot be set to <Auto> mode when this trigger action is enabled.

NOTE: The IR Cut Filter is not available for the camera GCI-K1603B.

- Send Message by FTP:

The Administrator can choose to send an alarm message by FTP when an alarm is detected.

- Send Message by E-Mail:

The Administrator can choose to send an alarm message by E-Mail when an alarm is triggered.

- Upload Image by FTP:

After selecting this item, the Administrator can assign a FTP site and configure various parameters as shown in the figure below. When the alarm is triggered, event images will be uploaded to the appointed FTP site.

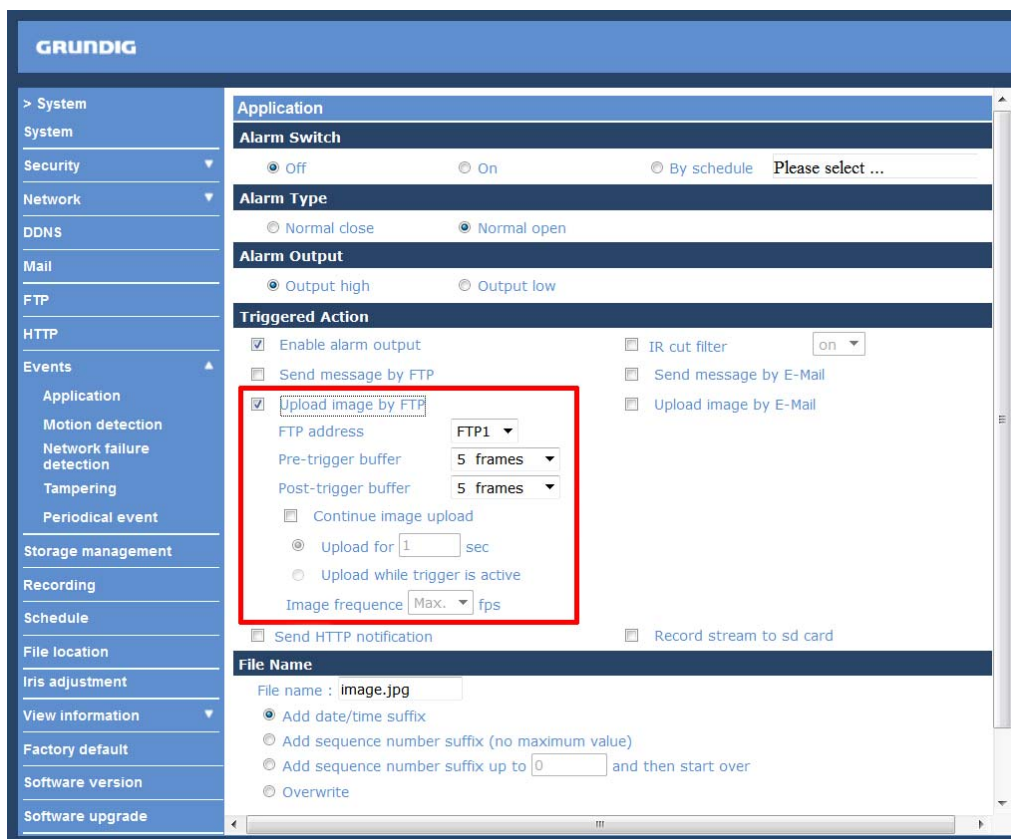

The <Pre-trigger buffer> recording function allows users to check what happened to trigger the alarm. The pre-trigger buffer time range is from 1 to 20 frames.

On the other hand, the <Post-trigger buffer> is for uploading a certain amount of images after the alarm input is triggered. The post-trigger buffer time range is from 1 to 20 frames.

Check the box <Continue image upload> to upload the triggered images during a certain time or keep uploading until the trigger is off.

- Select <Upload for __sec> and enter the duration in the blank. The images of the duration will be uploaded to the FTP when the alarm input is triggered. The setting range is from 1 to 9999 seconds.

- Select <Upload while trigger is active> to keep the images being uploaded to the FTP while the trigger is active, i.e. until the alarm is stopped.

Set the Image frequency as the upload frame rate. The setting range is from 1 frame to 15 frames.

NOTE: Please make sure that the local recording (with Micro SD/ SDHC card) is activated so that this function can be implemented. See section 9.12. Recording (on Camera) for further details.

- Upload Image by E-Mail:

After selecting this item, the Administrator can assign an e-mail address and configure various parameters as shown in the figure below. When the alarm is triggered, event images will be sent to the appointed e-mail address.

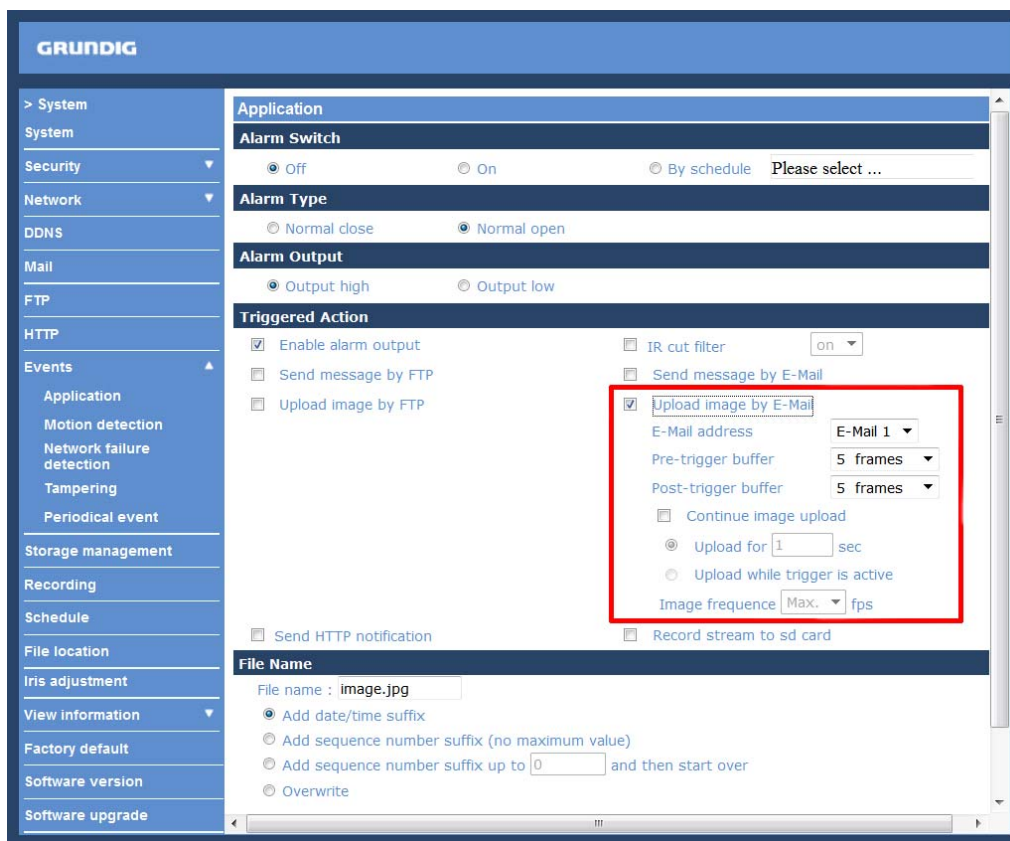

The <Pre-trigger buffer> recording function allows users to check what happened to trigger the alarm. The pre-trigger buffer time range is from 1 to 20 frames.

On the other hand, the <Post-trigger buffer> is for uploading a certain amount of images after the alarm input is triggered. The post-trigger buffer time range is from 1 to 20 frames.

Check the box <Continue image upload> to upload the triggered images during a certain time or keep uploading until the trigger is off.

- Select <Upload for __sec> and enter the duration in the blank. The images of the duration will be uploaded by E-Mail when the alarm input is triggered. The setting range is from 1 to 9999 seconds.

- Select <Upload while trigger is active> to keep the images being uploaded via E-Mail while the trigger is active, i.e. until the alarm is stopped.

Set the Image frequency as the upload frame rate. The setting range is from 1 frame to 15 frames.

NOTE: Make sure SMTP or FTP configuration has been completed. See section 9.5. Mail and 9.6. FTP for further details.

- Send HTTP notification:

Check this item, select the destination HTTP address, and specify the parameters for event notifications when an <Alarm> is triggered. As soon as an alarm is triggered, the notification will be sent to the specified HTTP server.

For instance, if the custom parameter is set as "action=1&group=2", and the HTTP server's name is "http://192.168.1.200/admin.php", the notification will be sent to the HTTP server as "http://192.168.1.200/admin.php? Action=1&group=2" when an alarm is triggered.

The screenshot shows the Grundig web interface for configuring alarm settings. The left sidebar contains a navigation menu with categories like System, Security, Network, DDNS, Mail, FTP, HTTP, Events, Storage management, Recording, Schedule, File location, Iris adjustment, View information, Factory default, Software version, and Software upgrade. The main content area is titled 'Application' and includes sections for 'Alarm Switch', 'Alarm Type', 'Alarm Output', 'Triggered Action', and 'File Name'. The 'Triggered Action' section is highlighted with a red box, showing the 'Send HTTP notification' checkbox checked. Below this, there are fields for 'HTTP address' (set to 'HTTP1') and 'Custom parameters'. The 'File Name' section includes a 'File name' field (set to 'image.jpg') and radio button options for adding date/time suffix, sequence number suffix, or overwriting.

- Record Stream to SD Card:

After selecting this item, the alarm-triggered recording will be saved on your Micro SD card.

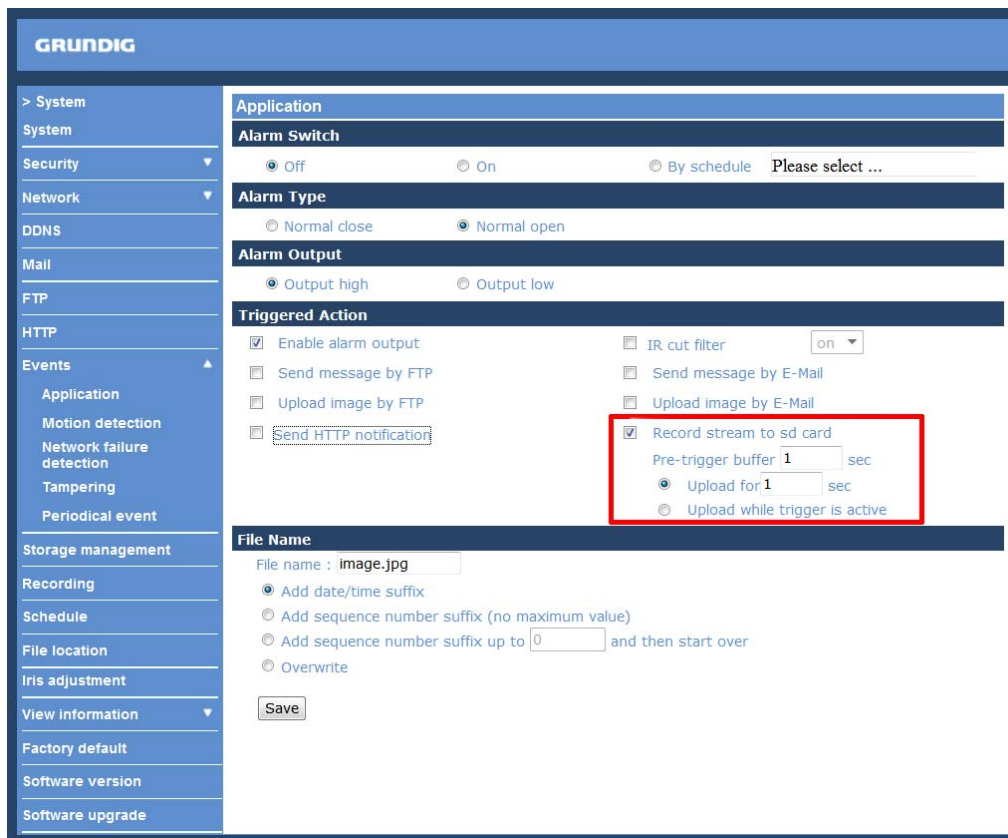

The pre-trigger buffer recording function allows users to check what happened to trigger the alarm. The pre-trigger buffer time range is from 1 to 3 seconds.

Select <Upload for __ sec> to set the recording duration after the alarm is triggered. The setting range is from 1 to 99999 seconds.

Select <Upload while trigger is active> to record the triggered video until the trigger is turned off.

File Name :

Enter a file name into the blank box, e.g. image.jpg. The uploaded image's file name format can be set in this section. Please select the one that meets your requirements.

- Add date/time suffix:

File name: imageYYMMDD_HHNNSS_XX.jpg

Y: Year, M: Month, D: Day

H: Hour, N: Minute, S: Second

X: Sequence Number

- Add sequence number suffix (no maximum value):

File name: imageXXXXXX.jpg

X: Sequence Number

- Add sequence number suffix up to _ and then start over:

File Name: imageXX.jpg

X: Sequence Number

The file name suffix will end at the number being set. For example, if the setting is "10", the file name will start from 00, end at 10, and then start all over again.

- Overwrite:

The original image in the FTP site will be overwritten with a static filename by the new uploaded file.

Save :

After completing all the settings mentioned above, please click on the Save button to save all the settings in this page.

9.9. Motion Detection

The Motion Detection function allows detecting suspicious motion and triggers alarms when motion volume in the detected area reaches/exceeds the determined sensitivity threshold value.

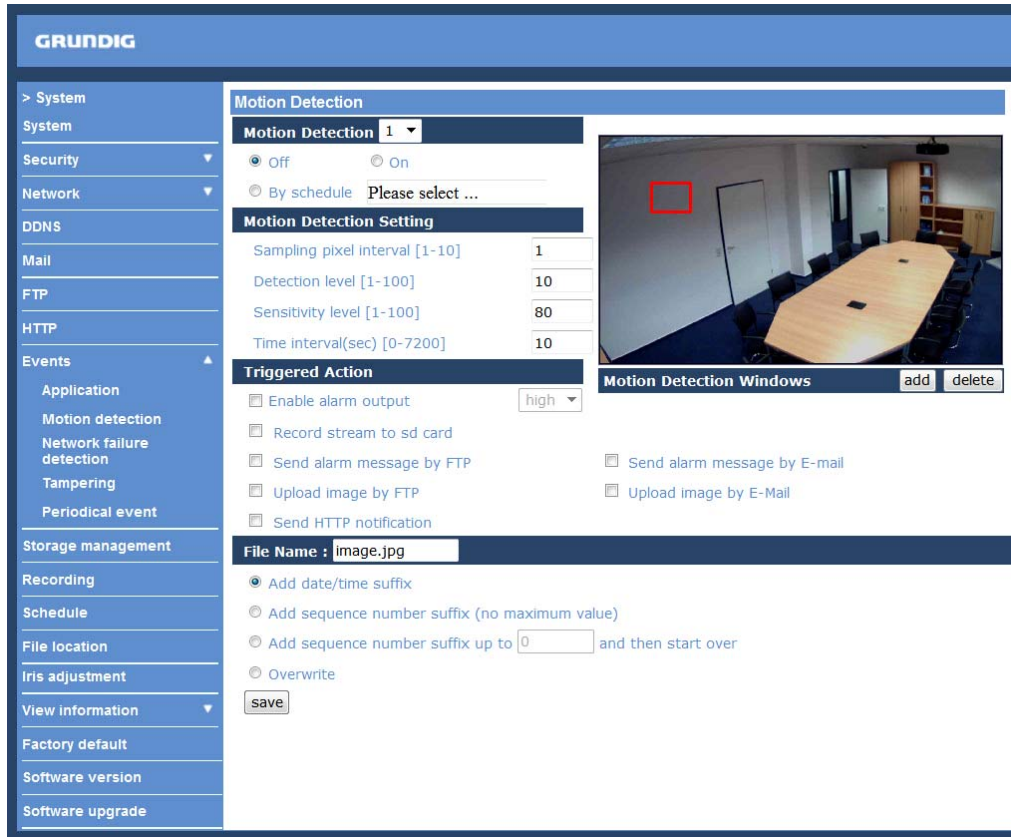

This function supports up to 4 sets of Motion Detection Settings. The settings can be chosen from the drop-down menu beside <Motion Detection>. In each set of the setting, there is a frame (Motion Detection Window) displayed on the Live Video Pane (shown in the picture below).

The Motion Detection Window is for defining the motion detection area. To change the size of the Motion Detection Window, move the mouse cursor to the edge of the frame and draw it outward/inward. Moving the mouse to the center of the frame can shift the frame to the intended location.

Up to 10 Motion Detection Windows can be set. click on the "Add" button under the Live View Pane to add a Motion Detection Window. To delete a Motion Detection Window, move the mouse cursor to the selected Window, and click on the "Delete" button.

If the Motion Detection function is activated, a pop-up window (Motion) with motion indication will be shown.

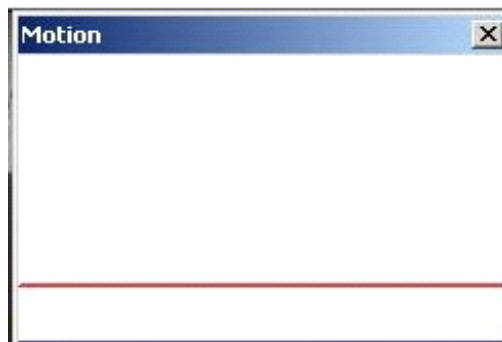

When motion is detected, the signals will be displayed in the Motion window as shown below:

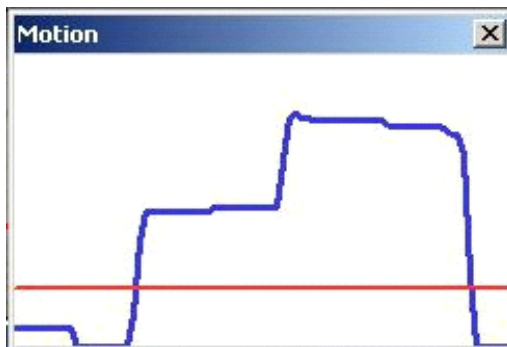

The detailed settings of Motion Detection are described as follows:

Motion Detection :

In each set of the Motion Detection Setting, the default setting for the Motion Detection function is <Off>. Enable this function by selecting <On>. Users can also activate the function according to the schedule previously set in the <Schedule> setting page. Select <By schedule> and click <Please select...> to choose the desired schedule from the drop-down menu.

Motion Detection Setting :

Users can adjust various parameters of Motion Detection in this section.

- Sampling pixel interval [1-10]:

The default value is 1. If the value is set as 3, it means that within the detection region, the system will take one sampling pixel for every 3 pixels by each row and each column (please refer to the figure below).

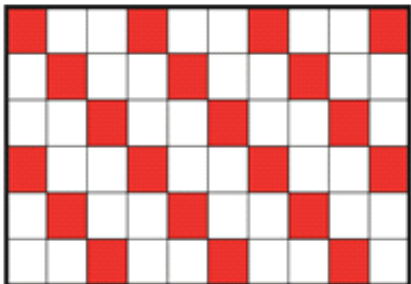

- Detection level [1-100]:

The default level is 10. This item is to set the detection level for each sampling pixel; the smaller the value, the more sensitive the detection is.

- Sensitivity level [1-100]:

The default level is 80, which means if 20% or more sampling pixels are detected as changing, the system will detect motion. The bigger the value, the more sensitive the detection is. Meanwhile, when the value is bigger, the red horizontal line in the motion indication window will be accordingly lower.

- Time interval (sec) [0-7200]:

The default interval is 10. This value is the interval between each detected motion.

Triggered Action (Multi-option) :

The Administrator can specify alarm actions that will take place when motion is detected. All options are listed as follows:

- Enable Alarm Output:

Check this item and select the predefined type of alarm output to enable alarm relay output when motion is detected.

- Record Stream to SD Card:

When you select this item, the Motion Detection recording will be stored on your Micro SD/SDHC card when motion is detected.

The screenshot shows a settings menu for 'Record stream to sd card'. It includes a checked checkbox for the title, a 'Pre-trigger buffer' field set to '1' with 'sec' to its right, and two radio button options: 'Upload for 1 sec' (unselected) and 'Upload while trigger is active' (selected).

The pre-trigger buffer recording function allows users to check what happened to trigger the alarm. The pre-trigger buffer time range is from 1 to 3 seconds.

Select <Upload for __ sec> to set the recording duration after the alarm is triggered. The setting range is from 1 to 99999 seconds.

Select <Upload while trigger is active> to record the triggered video until the trigger is turned off.

NOTE: Please make sure that the local recording (with Micro SD/ SDHC card) is activated so that this function can be implemented. See section 9.14. 'Recording (on Camera)' for further details.

- Send Message by FTP:

The Administrator can choose to send an alarm message by FTP when a motion is detected.

- Send Message by E-Mail:

The Administrator can choose to send an alarm message by E-Mail when a motion is detected.

- Upload Image by FTP:

After selecting this item, the Administrator can assign a FTP site and configure various parameters as shown in the picture below. When a motion is detected, event images will be uploaded to the appointed FTP site.

The screenshot shows a settings menu for 'Upload image by FTP'. It includes a checked checkbox for the title, an 'FTP address' dropdown menu set to 'FTP1', 'Pre-trigger buffer' and 'Post-trigger buffer' dropdown menus both set to '5 frames', a 'Continue image upload' checkbox (unchecked), two radio button options: 'Upload for 1 sec' (selected) and 'Upload while trigger is active' (unselected), and an 'Image frequency' dropdown menu set to 'Max.' with 'fps' to its right.

The <Pre-trigger buffer> recording function allows users to check what happened to trigger the alarm. The pre-trigger buffer time range is from 1 to 20 frames.

On the other hand, the <Post-trigger buffer> is for uploading a certain amount of images after the alarm input is triggered. The post-trigger buffer time range is from 1 to 20 frames.

Check the box <Continue image upload> to upload the triggered images during a certain time or keep uploading until the trigger is off.

- Select <Upload for __sec> and enter the duration in the blank. The images of the duration will be uploaded to the FTP when the alarm input is triggered. The setting range is from 1 to 9999 seconds.

- Select <Upload while trigger is active> to keep the images being uploaded to the FTP while the trigger is active, i.e. until the alarm is stopped.

Set the Image frequency as the upload frame rate. The setting range is from 1 frame to 15 frames.

- Upload Image by E-Mail:

After selecting this item, the Administrator can assign an e-mail address and configure various parameters as shown in the picture below. When a motion is detected, event images will be sent to the appointed e-mail address.

Upload image by E-Mail
E-Mail address: E-Mail 1
Pre-trigger buffer: 5 frames
Post-trigger buffer: 5 frames
 Continue image upload
 Upload for 1 sec
 Upload while trigger is active
Image frequency: Max. fps

The <Pre-trigger buffer> recording function allows users to check what happened to trigger the alarm. The pre-trigger buffer time range is from 1 to 20 frames.

On the other hand, the <Post-trigger buffer> is for uploading a certain amount of images after the alarm input is triggered. The post-trigger buffer time range is from 1 to 20 frames.

Check the box <Continue image upload> to upload the triggered images during a certain time or keep uploading until the trigger is off.

- Select <Upload for __sec> and enter the duration in the blank. The images of the duration will be uploaded via E-Mail when the alarm input is triggered. The setting range is from 1 to 9999 seconds.

- Select <Upload while trigger is active> to keep the images being uploaded via E-Mail while the trigger is active, i.e. until the alarm is stopped.

Set the Image frequency as the upload frame rate. The setting range is from 1 frame to 15 frames.

NOTE: Make sure SMTP or FTP configuration has been completed. See section 9.5. Mail and 9.6. FTP for further details.

- Send HTTP notification:

Check this item, select the destination HTTP address, and specify the parameters for event notifications when <Motion Detection> is triggered. When an alarm is triggered, the notification can be sent to the specified HTTP server.

For instance, if the custom parameter is set as "action=1&group=2", and the HTTP server's name is "http://192.168.1.200/admin.php", the notification will be sent to the HTTP server as "http://192.168.1.200/admin.php? Action=1&group=2" when an alarm is triggered.

Send HTTP notification
HTTP address: HTTP1
Custom parameters: []

File Name :

The uploaded image's filename format can be set in this section. Please select the one that meets your requirements (please see the section "File Name" in 9.8. 'Application (Alarm Settings)').

Save :

Click on the "Save" button to save all the Motion Detection alarm settings mentioned above.

9.10. Network Failure Detection

The Network Failure Detection function allows the IP Camera to ping another IP device (e.g. NVR, VSS, Video Server, etc.) within the network periodically and generates some actions in case of network failure occurrence, for instance, when a Video Server is somehow disconnected.

Being capable of implementing local recording (through Micro SD card) when a network failure happens, the IP Camera can be a backup recording device for the surveillance system.

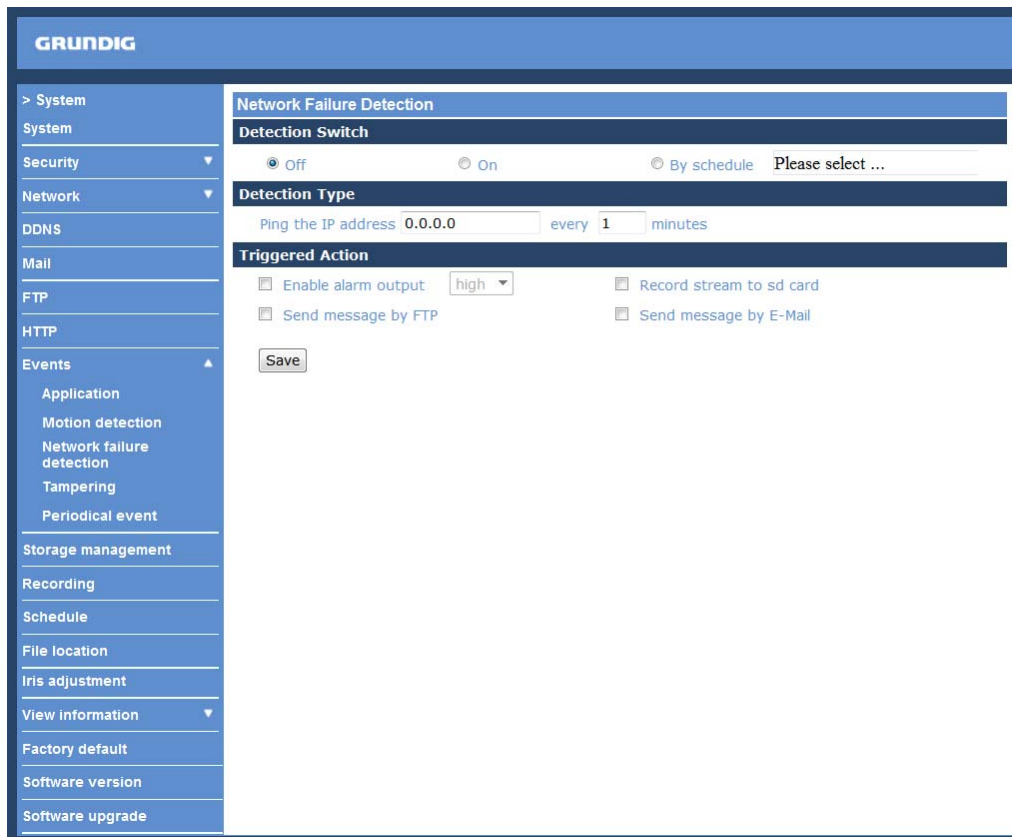

Detection Switch :

The default setting for the Detection Switch function is <Off>. Enable this function by selecting <On>. Users can also activate the function according to the schedule time that is was previously set in the <Schedule> setting page. Select <By schedule> and click <Please select...> to choose the desired schedule from the drop-down menu.

Detection Type :

Here you can set an IP address that should be pinged in order to detect network failure. Please also set the interval (in minutes) for this ping.

The ping time setting range is from 1 to 99 minutes.

Triggered Action (Multi-option) :

The Administrator can specify alarm actions that will take place when Network Failure is detected. All options are listed as follows:

- Enable Alarm Output:

Check this item and select the predefined type of alarm output to enable alarm relay output when network failure is detected.

- Record Stream to SD Card:

When you check this item, the alarm-triggered recording will be stored on your Micro SD/SDHC card when network failure is detected.

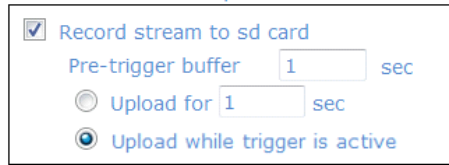

Record stream to sd card
Pre-trigger buffer sec
 Upload for sec
 Upload while trigger is active

The pre-trigger buffer recording function allows users to check what happened to trigger the alarm. The pre-trigger buffer time range is from 1 to 3 seconds.

Select <Upload for __ sec> to set the recording duration after the alarm is triggered. The setting range is from 1 to 99999 seconds.

Select <Upload while trigger is active> to record the triggered video until the trigger is turned off.

NOTE: Please make sure that the local recording (with Micro SD/ SDHC card) is activated so that this function can be implemented. See section 9.14. 'Recording (on Camera)' for further details.

- Send Message by FTP:

The Administrator can select whether to send an alarm message by FTP when Network Failure is detected.

- Send Message by E-Mail:

The Administrator can choose to send an alarm message by E-Mail when Network Failure is detected.

Save :

After completing all the settings mentioned above, please click on the Save button to save all the settings in this page.

9.11. Periodical Event

The device will send the designated frame numbers to the SD card in a specified time frame/duration.

Enable the function by selecting <On>.

Set the Time Interval by choosing from 60s to 3600s.

The screenshot shows the Grundig web interface for configuring the 'Periodical event' function. The interface is divided into a left sidebar and a main content area. The sidebar contains various system settings categories. The main content area is titled 'Periodical event' and includes a toggle switch to enable or disable the function. Below this, there is a 'Time interval' section with a 'Minimum interval' set to 60 seconds. The 'Triggered Action' section allows users to select which actions to perform when an event is triggered, such as uploading images to an FTP site, an email address, or an SD card. Each action has associated configuration fields for addresses, buffers, and file names. A 'Save' button is located at the bottom of the configuration area.

- Upload Image by FTP:

After selecting this item, the Administrator can assign a FTP site and configure various parameters as shown in the figure below. When the alarm is triggered, event images will be uploaded to the appointed FTP site.

The <Pre-trigger buffer> recording function allows users to check what happened to trigger the alarm. The pre-trigger buffer time range is from 1 to 20 frames.

On the other hand, the <Post-trigger buffer> is for uploading a certain amount of images after the alarm input is triggered. The post-trigger buffer time range is from 1 to 20 frames.

Check the box <Continue image upload> to upload the triggered images during a certain time or keep uploading until the trigger is off.

- Select <Upload for __sec> and enter the duration in the blank. The images of the duration will be uploaded to the FTP when the alarm input is triggered. The setting range is from 1 to 9999 seconds.

- Select <Upload while trigger is active> to keep the images being uploaded to the FTP while the trigger is active, i.e. until the alarm is stopped.

Set the Image frequency as the upload frame rate. The setting range is from 1 frame to 15 frames.

NOTE: Please make sure that the local recording (with Micro SD/ SDHC card) is activated so that this function can be implemented. See section 9.14. Recording (on Camera) for further details.

- Upload Image by E-Mail:

After selecting this item, the Administrator can assign an e-mail address and configure various parameters as shown in the picture below. When a motion is detected, event images will be sent to the appointed e-mail address.

The <Pre-trigger buffer> recording function allows users to check what happened to trigger the alarm. The pre-trigger buffer time range is from 1 to 20 frames.

On the other hand, the <Post-trigger buffer> is for uploading a certain amount of images after the alarm input is triggered. The post-trigger buffer time range is from 1 to 20 frames.

Check the box <Continue image upload> to upload the triggered images during a certain time or keep uploading until the trigger is off.

- Select <Upload for __sec> and enter the duration in the blank. The images of the duration will be uploaded via E-Mail when the alarm input is triggered. The setting range is from 1 to 9999 seconds.

- Select <Upload while trigger is active> to keep the images being uploaded via E-Mail while the trigger is active, i.e. until the alarm is stopped.

Set the Image frequency as the upload frame rate. The setting range is from 1 frame to 15 frames.

NOTE: Make sure SMTP or FTP configuration has been completed. See section 9.5. Mail and 9.6. FTP for further details.

- Upload image to sd card:

Enable the SD card recording by ticking the box next to "Upload image to sd card".

Pre-trigger buffer: The device will send designated frame numbers before the event (1~20 frames).

Post-trigger buffer: The device will send designated frame numbers after the event (1~20 frames).

File Name :

The uploaded image's filename format can be set in this section. Please select the one that meets your requirements (please see the section "File Name" in 9.8. 'Application (Alarm Settings)').

Save :

After completing all the settings mentioned above, please click on the Save button to save all the settings in this page.

9.12. Tampering

The Tampering Alarm function helps the IP Camera against tampering such as deliberate redirection, blocking, spray paint, lens covering, etc. through video analysis and reaction to such events by sending out notifications or uploading snapshots to the specified destination(s).

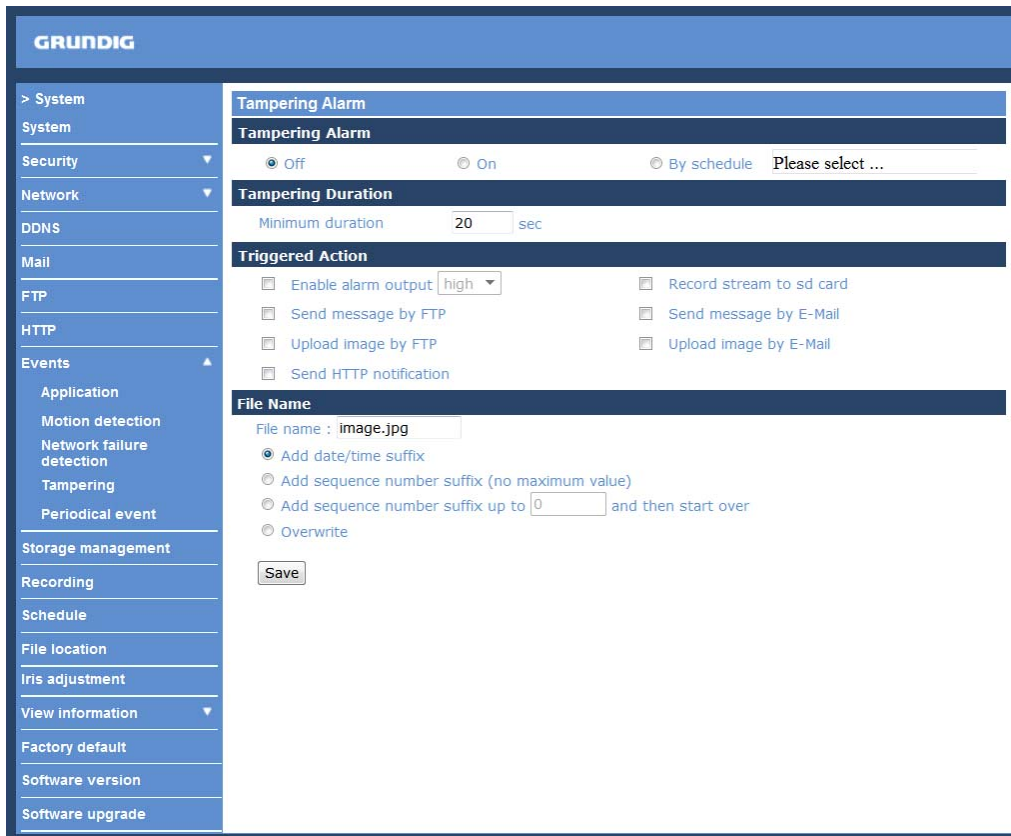

Detection of camera tampering is achieved by measuring the differences between the older frames of video (which are stored in buffers) and more recent frames.

Tampering Alarm :

You will be able to turn the Tampering Alarm function on/off in the Tampering Alarm setting section. The default setting is: Off.

Tampering Duration :

The Minimum Tampering Duration is the time the video analysis will need to determine whether any camera tampering has occurred. Defining the Minimum Duration can also be interpreted as defining the Tampering threshold; longer duration represents a higher threshold. The settable Tampering Duration time range is from 10 to 3600 seconds.

Triggered Action (Multi-option) :

The Administrator can specify alarm actions that will take place when tampering is detected. All options are listed as follows:

- Enable Alarm Output:

Check this item and select the predefined type of alarm output to enable alarm relay output when tampering is detected.

- Record Stream to SD Card:

When you check this item, the alarm-triggered recording will be stored on your Micro SD/SDHC card when tampering is detected.

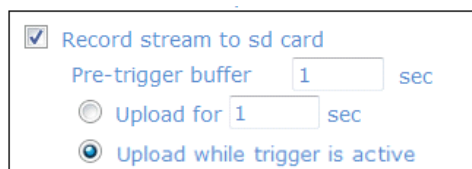

The pre-trigger buffer recording function allows users to check what happened to trigger the alarm. The pre-trigger buffer time range is from 1 to 3 seconds.

Select <Upload for __ sec> to set the recording duration after the alarm is triggered. The setting range is from 1 to 99999 seconds.

Select <Upload while trigger is active> to record the triggered video until the trigger is turned off.

NOTE: Please make sure that the local recording (with Micro SD/ SDHC card) is activated so that this function can be implemented. See section 9.14. 'Recording (on Camera)' for further details.

- Send Message by FTP:

The Administrator can select whether to send an alarm message by FTP when tampering is detected.

- Send Message by E-Mail:

The Administrator can choose to send an alarm message by E-Mail when tampering is detected.

- Upload Image by FTP:

After selecting this item, the Administrator can assign a FTP site and configure various parameters as shown in the figure below. When tampering is detected, event images will be uploaded to the appointed FTP site.

Upload image by FTP
FTP address: FTP1
Pre-trigger buffer: 5 frames
Post-trigger buffer: 5 frames
 Continue image upload
 Upload for 1 sec
 Upload while trigger is active
Image frequency: Max. fps

The <Pre-trigger buffer> recording function allows users to check what happened to trigger the alarm. The pre-trigger buffer time range is from 1 to 20 frames.

On the other hand, the <Post-trigger buffer> is for uploading a certain amount of images after the alarm input is triggered. The post-trigger buffer time range is from 1 to 20 frames.

Check the box <Continue image upload> to upload the triggered images during a certain time or keep uploading until the trigger is off.

- Select <Upload for __sec> and enter the duration in the blank. The images of the duration will be uploaded to the FTP when the alarm input is triggered. The setting range is from 1 to 9999 seconds.

- Select <Upload while trigger is active> to keep the images being uploaded to the FTP while the trigger is active, i.e. until the alarm is stopped.

Set the Image frequency as the upload frame rate. The setting range is from 1 frame to 15 frames.

- Upload Image by E-Mail:

After selecting this item, the Administrator can assign an e-mail address and configure various parameters as shown in the figure below. When tampering is detected, event images will be sent to the appointed e-mail address.

Upload image by E-Mail
E-Mail address: E-Mail 1
Pre-trigger buffer: 5 frames
Post-trigger buffer: 5 frames
 Continue image upload
 Upload for 1 sec
 Upload while trigger is active
Image frequency: Max. fps

The <Pre-trigger buffer> recording function allows users to check what happened to trigger the alarm. The pre-trigger buffer time range is from 1 to 20 frames.

On the other hand, the <Post-trigger buffer> is for uploading a certain amount of images after the alarm input is triggered. The post-trigger buffer time range is from 1 to 20 frames.

Check the box <Continue image upload> to upload the triggered images during a certain time or keep uploading until the trigger is off.

- Select <Upload for __sec> and enter the duration in the blank. The images of the duration will be uploaded via E-Mail when the alarm input is triggered. The setting range is from 1 to 9999 seconds.

- Select <Upload while trigger is active> to keep the images being uploaded via E-Mail while the trigger is active, i.e. until the alarm is stopped.

Set the Image frequency as the upload frame rate. The setting range is from 1 frame to 15 frames.

NOTE: Make sure SMTP or FTP configuration has been completed. See section 9.5. Mail and 9.6. FTP for further details.

- Send HTTP notification:

Check this item, select the destination HTTP address, and specify the parameters for HTTP notifications. When the Tampering Alarm is triggered, the HTTP notifications can be sent to the specified HTTP server.

For instance, if the custom parameter is set as "action=1&group=2", and the HTTP server's name is "http://192.168.1.200/admin.php", the notification will be sent to the HTTP server as "http://192.168.1.200/admin.php? Action=1&group=2" when an alarm is triggered.

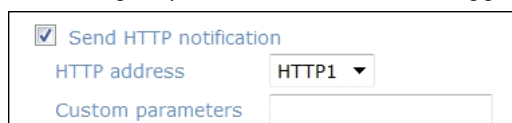

The screenshot shows a configuration form for sending HTTP notifications. It includes a checked checkbox labeled "Send HTTP notification". Below it, there are three fields: "HTTP address" with a dropdown menu currently showing "HTTP1", and "Custom parameters" with an empty text input field.

File Name :

The uploaded image's filename format can be set in this section. Please select the one that meets your requirements (please see the section "File Name" in 9.8. 'Application (Alarm Settings)').

Save :

Click the Save button to save all the Tampering Alarm settings mentioned above.

9.13. Storage Management (on Camera)

Users can store local recordings on a Micro SD/SDHC card of up to 32 GB. This page shows the capacity information of the Micro SD card and a recording list with all the recording files saved on the memory card. Users can also format the SD card and implement automatic recording cleanup through the setting page.

To implement Micro SD card recording, please go to the "Recording" page (see 9.14. 'Recording (on Camera)') for activation.

NOTE: Please format the Micro SD/SDHC card when using it for the first time. Formatting will also be required when a memory card has already been used on one device and was later transferred to another device with a different software platform.

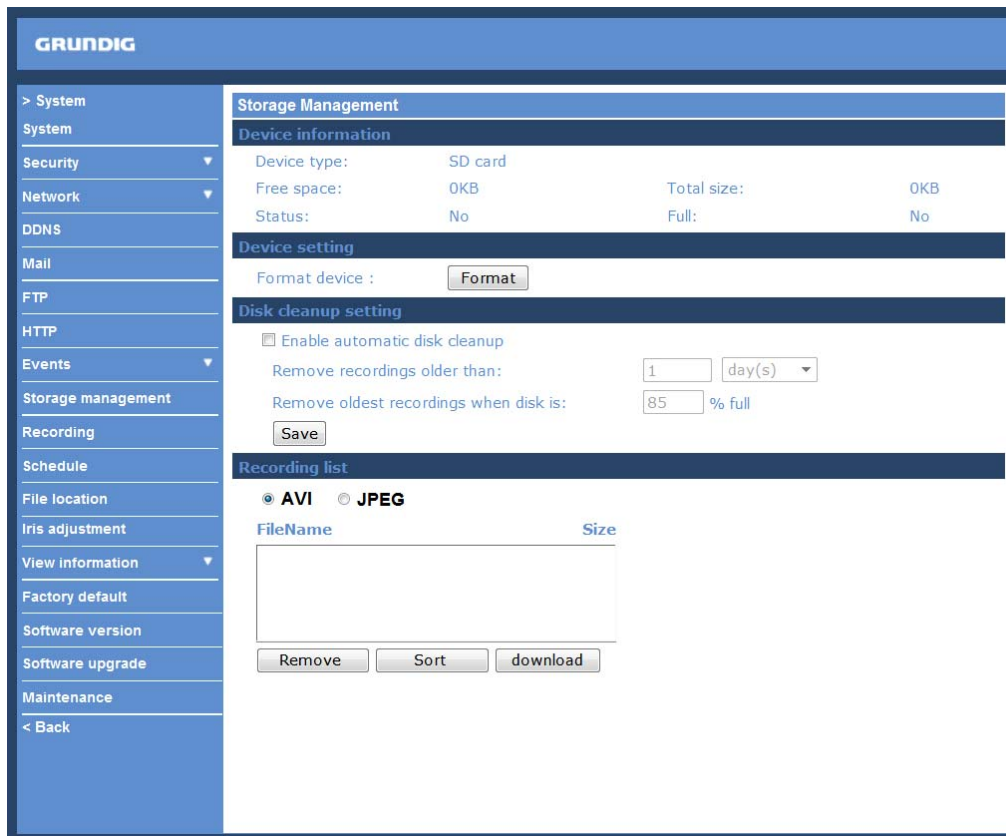

Device Information :

When users insert the Micro SD/SDHC card, the card information such as the memory capacity and status will be shown in the Device Information section. The memory card is successfully installed if its status is shown in the "Device information" section in the Storage Management page.

Device Setting :

Click on the "Format" button to format the memory card.

Disk Cleanup Setting :

Users can enable an automatic recordings cleanup by checking this item and specifying the time and storage limits.

Recording List :

Each video file on the Micro SD/SDHC card will be listed in the Recording list as shown below. The maximum file size is 60 MB (60 MB per file).

If the recording modus is set to "Always" and at the same time the event recording (when a motion detection or an alarm takes place) is also turned on, in this case, when an event occurs, the event will be recorded first, afterwards the camera will return to normal recording mode.

When the recording mode is set to "Always" (consecutive recording) in the submenu "Recording" and the Micro SD/SDHC card recording is also allowed to be enabled when triggered by events, once the events occur, the system will immediately implement the recorded events to the memory card. After event recording, the device will return to regular recording mode.

Recording list	
FileName	Size
M_20110325_175641.avi	1114 K
M_20110325_175800.avi	14855 K
M_20110325_175824.avi	9901 K
M_20110325_180018.avi	16938 K
M_20110325_180047.avi	16904 K

Remove Sort Download

- Remove:

To remove a file, select the file first, and then click on the "Remove" button.

- Sort:

When you click on the "Sort" button, the files in the Recording list will be listed in name and date order.

NOTE: The capital letters (A, M or R) appearing in the very beginning of a name denote the sort of the recording: A stands for Alarm, M stands for Motion and R stands for regular recording.

- Download:

To open/download a video clip, select the file first, and then click on the "Download" button underneath the Recording list field. The selected file window will pop up as shown below. Click on the AVI file to directly play the video in the player or download it to a specified location.

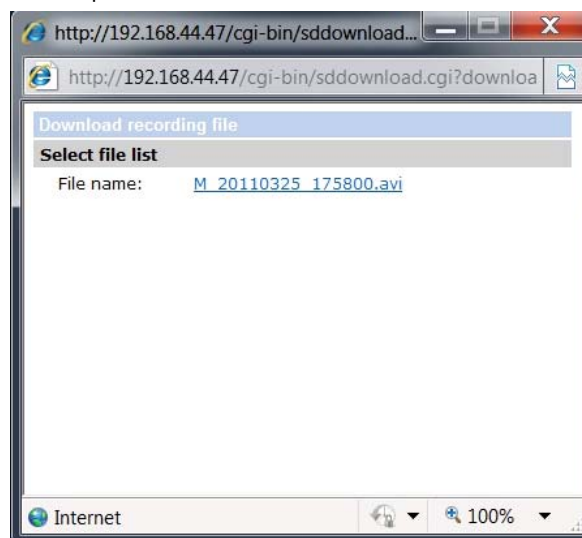

9.14. Recording (on Camera)

In the Recording setting page, the Micro SD Card recording schedule supports up to ten sets of time frames. Users can specify the recording schedule to fit their present surveillance requirements.

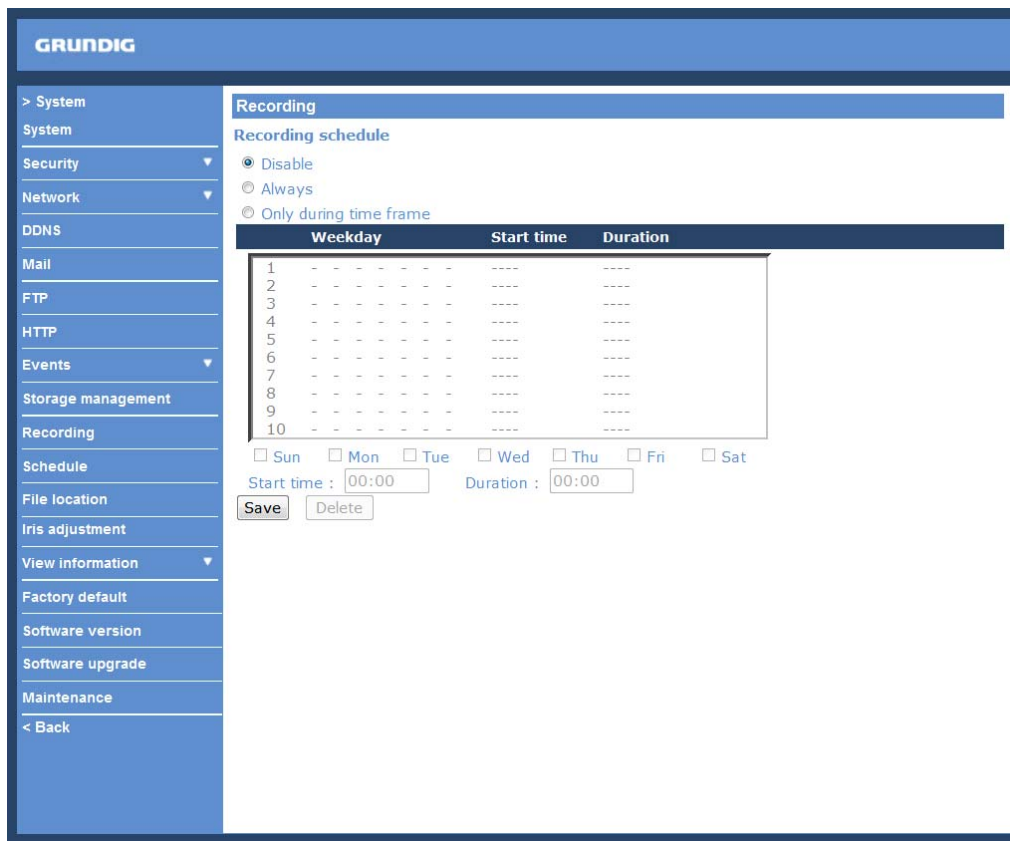

Activating Micro SD/SDHC Card Recording :

Two types of schedule mode are offered: "Always" and "Only during time frame". You can set up the time frame according to your requirements or you can choose "Always" to allow the Micro SD/SDHC Card Recording to be activated all the time. Or select a set of schedules from the time frame blank, check specific weekdays and set up the start time (hour:minute) and time period (hour:minute) to activate the Micro SD/SDHC Card Recording in certain time frames. The setting range for the time period hour is from 0 to 168.

Please click on the "Save" button to confirm the schedule mode.

Terminating Micro SD/SDHC Card Recording :

Select "Disable" to terminate the recording function.

9.15. Schedule

This function allows the users to setup schedules for features including: <Alarm Switch>, <Motion Detection> and <Network Failure Detection>. The function supports up to 10 sets of time frames in the time frame list.

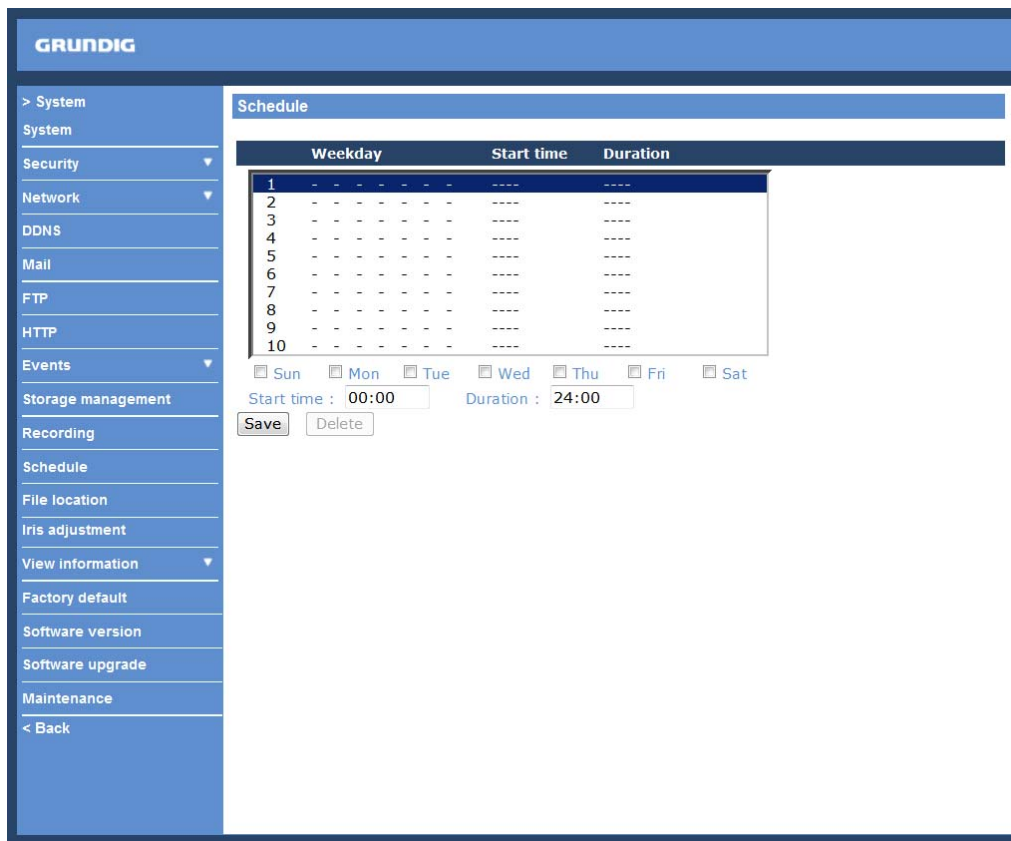

Setting a schedule:

To set a schedule, please select a time frame from the time frame list first. Then check the boxes at the bottom of the time frame to choose the specific weekdays. At last, type in the start time (hour:minute) and the duration time (hour:minute) for activation of the schedule triggered features. The setting range for the duration time is from 00:00 to 168:59.

Click <Delete> to delete a chosen time frame.

Click on <Save> to confirm the setting.

NOTE: Users MUST select <By schedule> for each feature (in the setting page of the feature) to enable the schedule function for this feature.

The features are: <Alarm Switch> (in the "Application" page), <Motion Detection> and <Network Failure Detection>.

9.16. File Location (on PC)

Users can specify a storage location for the snapshots and the live video recording. The default setting is: C:\. Once the setting is confirmed, click on "Save," and all the snapshots and recordings will be saved in the designated location.

NOTE: Please make sure the selected file path contains valid characters such as letters and numbers.

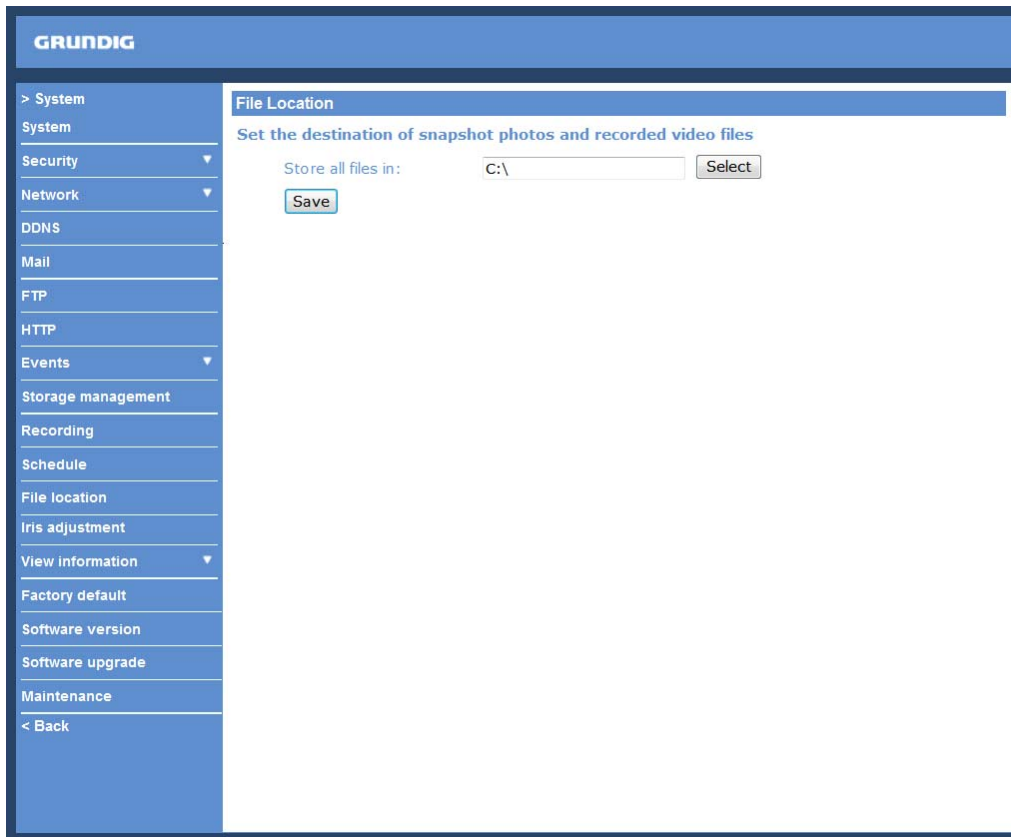

NOTE: Users with the Windows 7 operating system on their PC need to follow the following procedure to be able to use the Snapshot function. First you need to log on to your computer as an Administrator. Then please go to Windows Start menu, click with the right mouse button on your Internet Browser and select in the appearing pop-up window "Run as Administrator". Afterwards you can log in to your camera as usual (as an administrator or user).

9.17. Iris Adjustment

For users who use an auto-iris lens, when it is required to undertake an iris adjustment, please refer to the iris adjustment procedure in the sub-menu "Iris Adjustment" to adjust the iris.

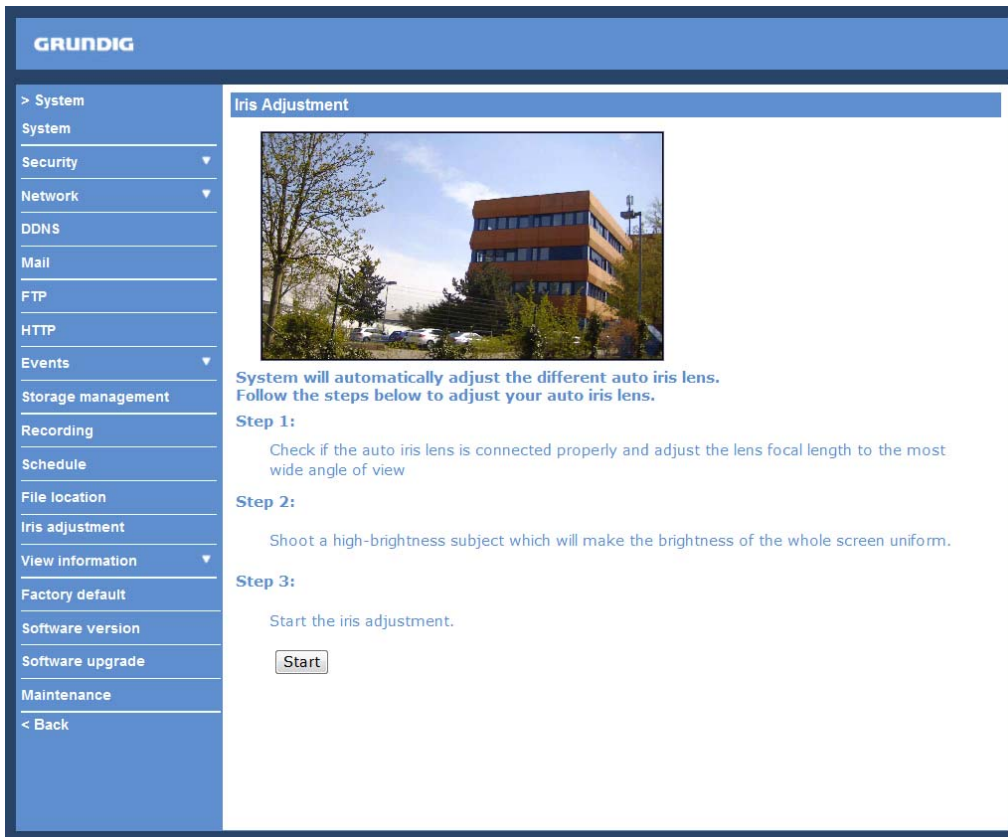

The screenshot shows the Grundig web interface. On the left is a navigation menu with the following items: > System, System, Security, Network, DDNS, Mail, FTP, HTTP, Events, Storage management, Recording, Schedule, File location, Iris adjustment, View information, Factory default, Software version, Software upgrade, Maintenance, and < Back. The main content area is titled "Iris Adjustment" and features a photograph of a modern building. Below the photo, the text reads: "System will automatically adjust the different auto iris lens. Follow the steps below to adjust your auto iris lens." The instructions are as follows:

- Step 1:** Check if the auto iris lens is connected properly and adjust the lens focal length to the most wide angle of view
- Step 2:** Shoot a high-brightness subject which will make the brightness of the whole screen uniform.
- Step 3:** Start the iris adjustment.

A "Start" button is located below the instructions.

9.18. View Information

<Parameters>:

Click on this item to view the entire system's parameter setting.

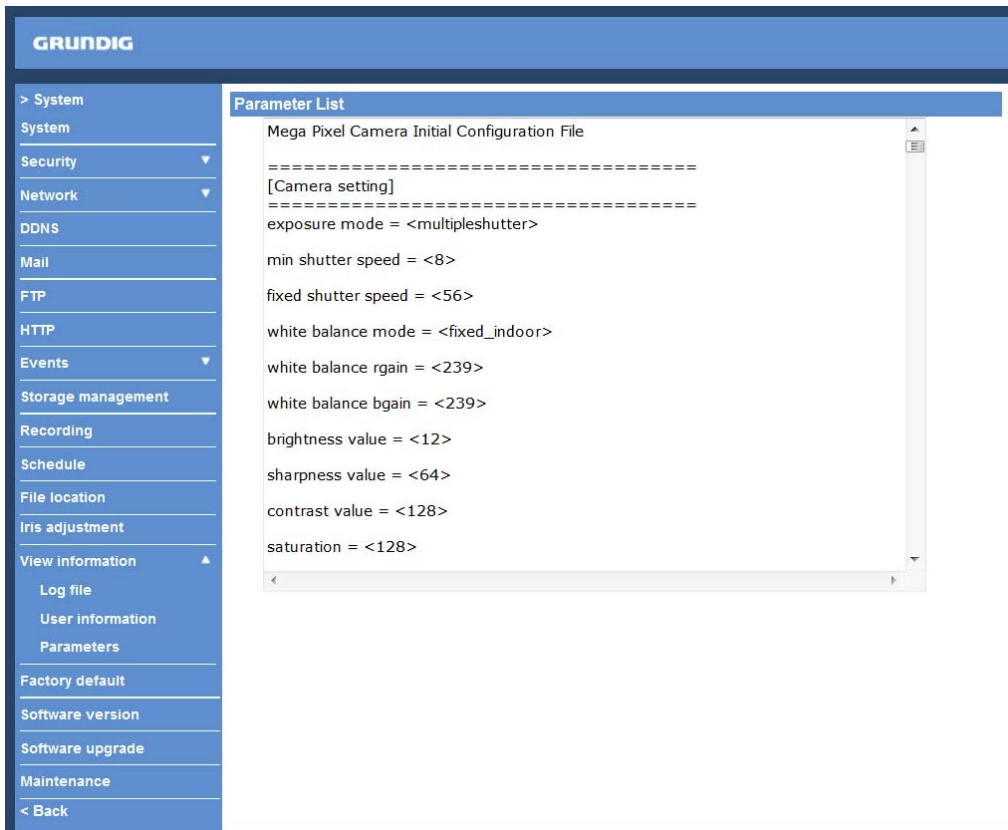

The screenshot shows the Grundig web interface with the "View information" menu expanded. The "Parameters" option is selected. The main content area is titled "Parameter List" and displays the following configuration details:

```
Mega Pixel Camera Initial Configuration File
=====
[Camera setting]
=====
exposure mode = <multipleshutter>

min shutter speed = <8>

fixed shutter speed = <56>

white balance mode = <fixed_indoor>

white balance rgain = <239>

white balance bgain = <239>

brightness value = <12>

sharpness value = <64>

contrast value = <128>

saturation = <128>
```

<Log File>:

Click on the link to view the system log file. The content of this file provides useful information about configuration and connections after system boot-up.

GRUNDIG

> System

- System
- Security
- Network
- DDNS
- Mail
- FTP
- HTTP
- Events
- Storage management
- Recording
- Schedule
- File location
- Iris adjustment
- View information
 - Log file
 - User information
 - Parameters
- Factory default
- Software version
- Software upgrade
- Maintenance
- < Back

System Log

```
[Thu Apr 22 11:18:27 2010] --admin@::ffff:192.168.44.40 GET /cgi-bin/admin/para
[Thu Apr 22 11:18:29 2010] --admin@::ffff:192.168.44.40 GET /cgi-bin/admin/para
[Thu Apr 22 11:18:29 2010] --admin@::ffff:192.168.44.40 GET /cgi-bin/com/ptz.cc
[Thu Apr 22 11:19:03 2010] --admin@::ffff:192.168.44.40 GET /cgi-bin/admin/para
[Thu Apr 22 11:19:04 2010] --admin@::ffff:192.168.44.40 GET /cgi-bin/admin/para
[Thu Apr 22 11:19:05 2010] --admin@::ffff:192.168.44.40 GET /cgi-bin/admin/para
[Thu Apr 22 11:19:05 2010] --admin@::ffff:192.168.44.40 GET /cgi-bin/com/ptz.cc
[Thu Apr 22 11:19:39 2010] --admin@::ffff:192.168.44.40 GET /cgi-bin/admin/para
[Thu Apr 22 11:19:40 2010] --admin@::ffff:192.168.44.40 GET /cgi-bin/admin/para
[Thu Apr 22 11:19:41 2010] --admin@::ffff:192.168.44.40 GET /cgi-bin/admin/para
[Thu Apr 22 11:19:41 2010] --admin@::ffff:192.168.44.40 GET /cgi-bin/com/ptz.cc
[Thu Apr 22 11:20:15 2010] --admin@::ffff:192.168.44.40 GET /cgi-bin/admin/para
[Thu Apr 22 11:20:16 2010] --admin@::ffff:192.168.44.40 GET /cgi-bin/admin/para
[Thu Apr 22 11:20:17 2010] --admin@::ffff:192.168.44.40 GET /cgi-bin/admin/para
[Thu Apr 22 11:20:17 2010] --admin@::ffff:192.168.44.40 GET /cgi-bin/com/ptz.cc
[Thu Apr 22 11:20:50 2010] --admin@::ffff:192.168.44.40 GET /cgi-bin/admin/para
[Thu Apr 22 11:20:51 2010] --admin@::ffff:192.168.44.40 GET /cgi-bin/admin/para
[Thu Apr 22 11:20:53 2010] --admin@::ffff:192.168.44.40 GET /cgi-bin/admin/para
[Thu Apr 22 11:20:53 2010] --admin@::ffff:192.168.44.40 GET /cgi-bin/com/ptz.cc
[Thu Apr 22 11:21:25 2010] --admin@::ffff:192.168.44.40 GET /cgi-bin/admin/para
[Thu Apr 22 11:21:27 2010] --admin@::ffff:192.168.44.40 GET /cgi-bin/admin/para
[Thu Apr 22 11:21:28 2010] --admin@::ffff:192.168.44.40 GET /cgi-bin/admin/para
[Thu Apr 22 11:21:28 2010] --admin@::ffff:192.168.44.40 GET /cgi-bin/com/ptz.cc
[Thu Apr 22 11:22:01 2010] --admin@::ffff:192.168.44.40 GET /cgi-bin/admin/para
```

<User Information>:

The Administrator can view each user's login information and their privileges (see section 9.2. Security).

View User Login Information :

All the users in the network will be listed in the "User Information" zone, as shown below. The picture below shows: User: 4321

This indicates that one user's login username is: User, and the password is: 4321

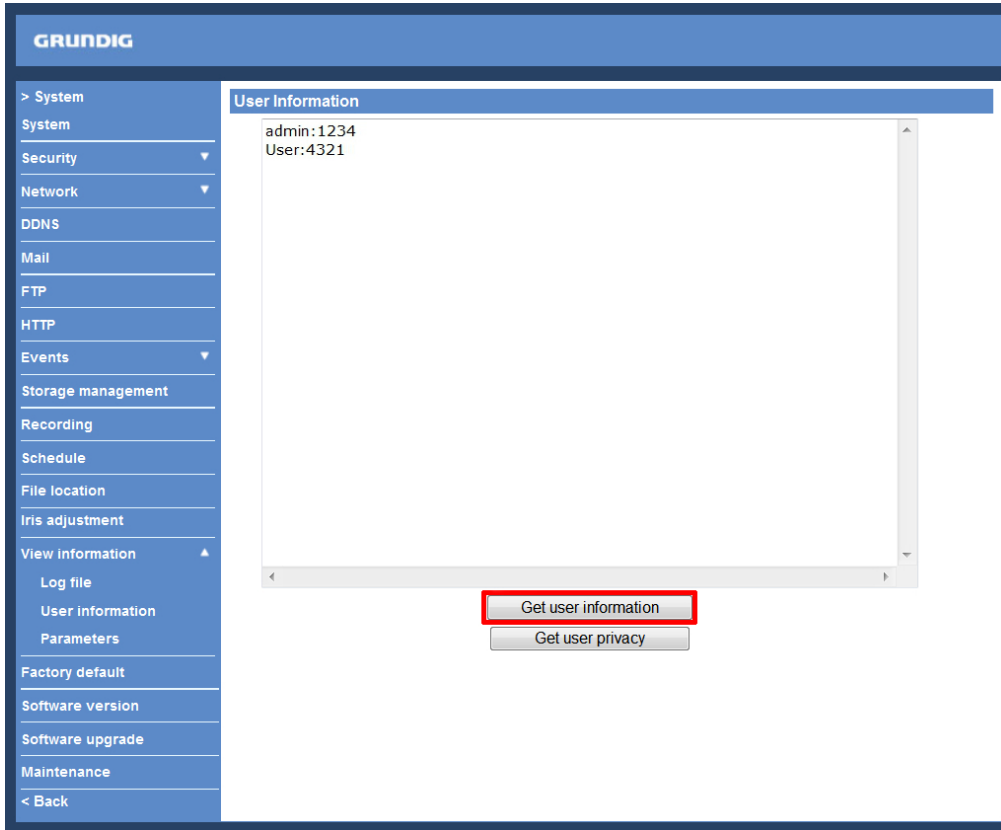

View User Privilege :

If you click on "Get user privacy" at the bottom of the page, the Administrator will be able to view each user's privileges.

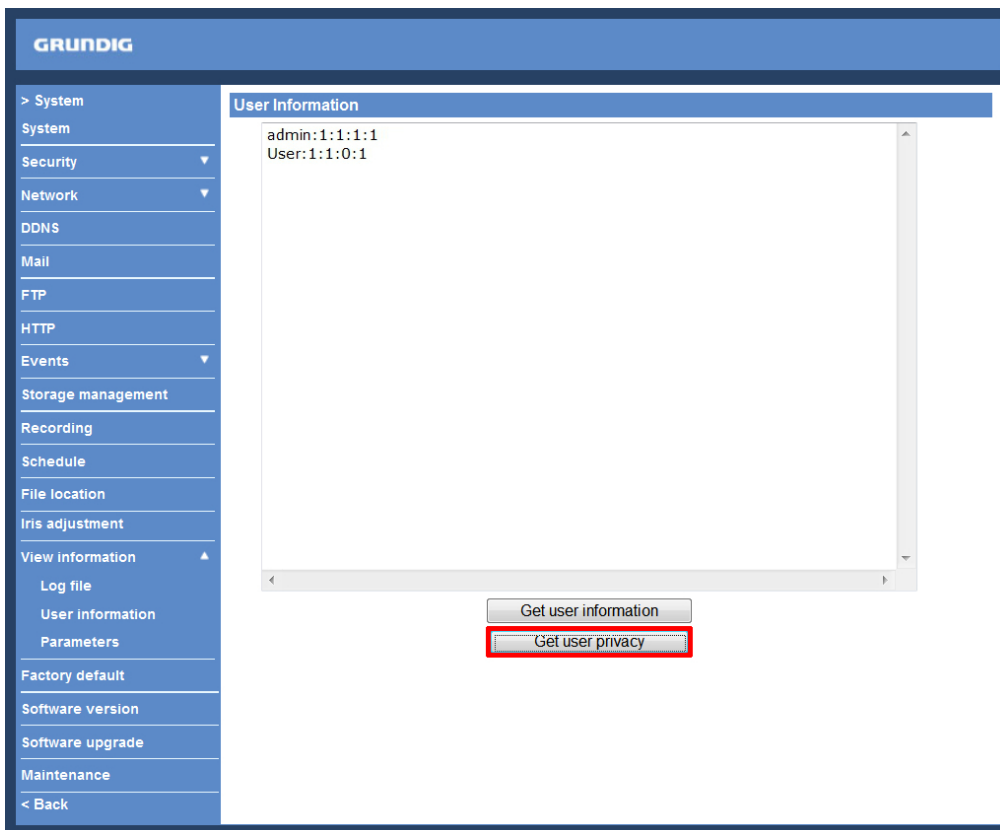

As the picture above shows: User: 1:1:0:1

1:1:0:1 = I/O access : Camera control : Talk : Listen (see 9.2. Security)

This denotes that the user has been granted the privileges of I/O access, Camera control and Listen.



9.19. Factory Default

The factory default setting page is shown below. Follow the instructions to reset the IP Camera to factory default setting if needed.

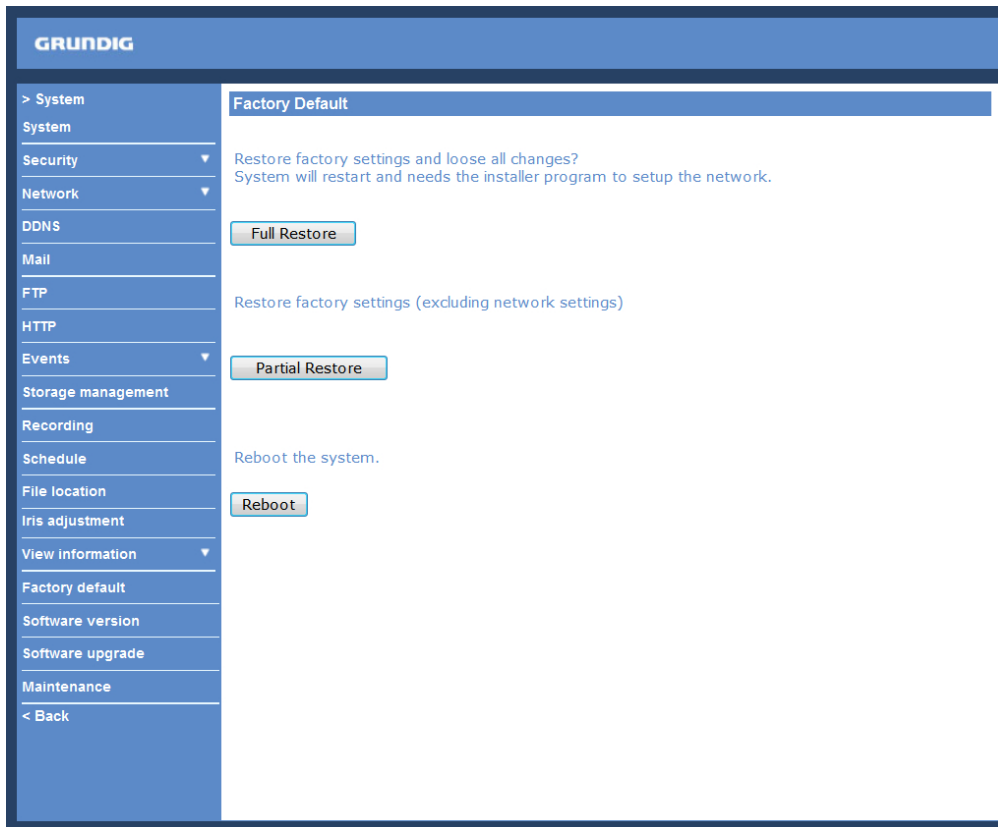

Full Restore :

Click on the “Full Restore” button to recall the factory default settings. After 30 seconds the system will restart.

NOTE: The IP address will also be restored to default (192.168.1.1).

Partial Restore :

Click on the “Partial Restore” button to recall the factory default settings, except for the network settings.

Reboot :

When you click on the “Reboot” button, the system will restart without changing the current settings.

9.20. Software Version

The current software version is displayed in the software version page, which is shown in the picture below.

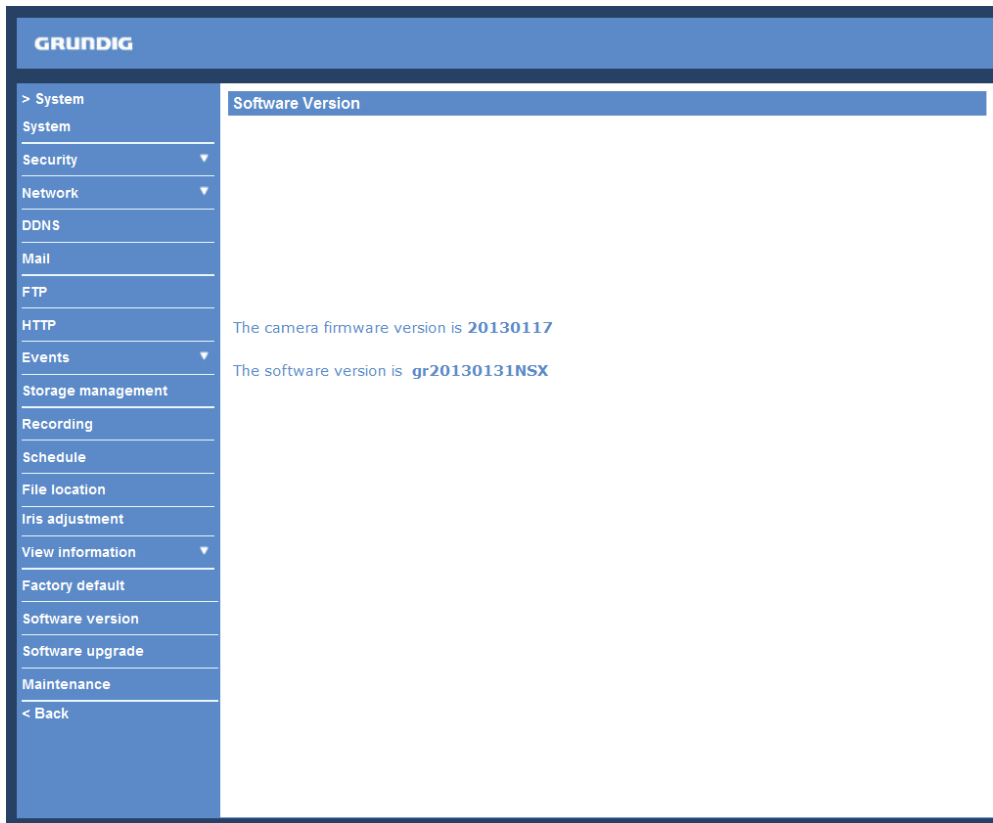

9.21. Software Upgrade

Software upgrade can be carried out on the "Software Upgrade" page, as shown below.



NOTE: Make sure the upgrade software file is available before carrying out the software upgrade.

The procedure of a software upgrade is as follows:

Step 1: Click on “Browse” and select the following binary file to be uploaded: GCI-Firmware.

NOTE: Do not change the upgrade file name, or the system will fail to find the file.

Step 2: Pull down the upgrade binary file list and select the file you want to upgrade; in this case, select “GCI-Firmware”.

Step 3: Click on “Upgrade”. The system will first check whether the upgrade file exists or not, and then begin to upload the upgrade file. Subsequently, the upgrade status bar will be displayed on the page. When 100% is reached, the upgrade process is finished.

After the upgrade process is finished, the Viewer will return to the Home page.

Step 4: Close the video browser.

Step 5: Go to “Start” on your Windows desktop, activate “Control Panel”, and then double-click on “Add or Remove Programs”. In the “Currently installed programs” list, select “GRUNDIG Viewer” and click on the button “Remove” to uninstall the existing GRUNDIG Viewer.

Step 6: Open a new web browser, re-login the IP Camera, and then allow the automatic download of the GRUNDIG Viewer.

9.22. Maintenance

Users can export configuration files to a specified location and retrieve data by uploading an existing configuration file to the IP Camera. This is especially convenient if you want to have the same configuration for multiple cameras.

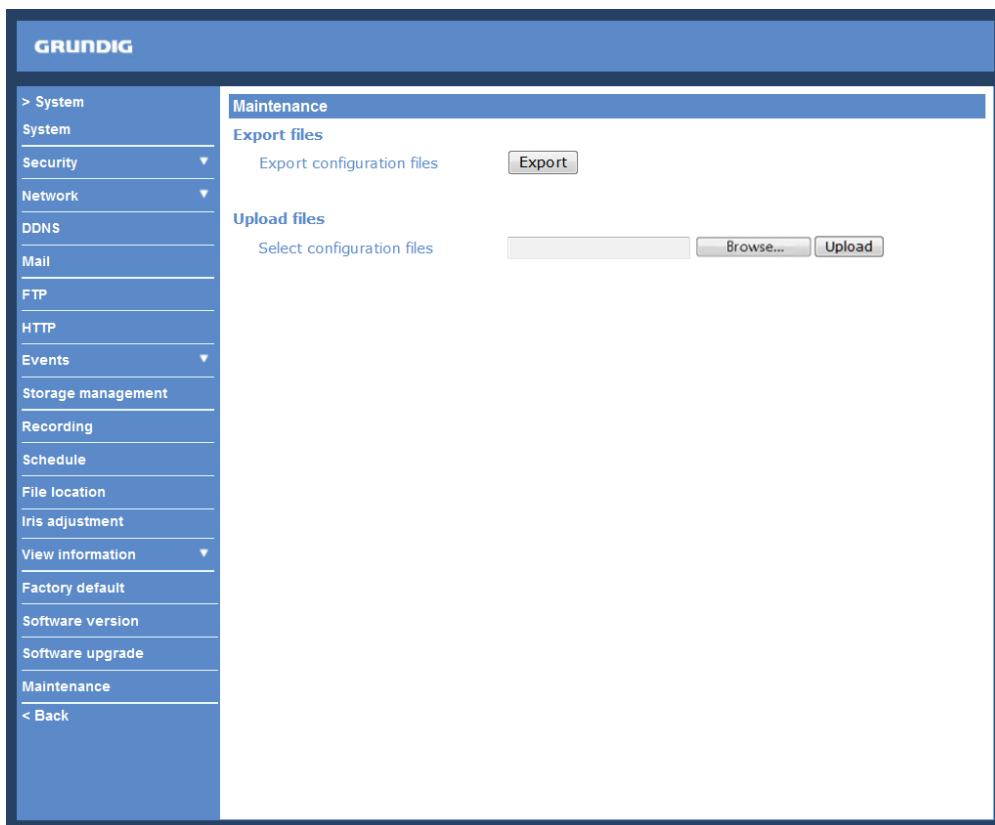

Export:

Users can save the system settings by exporting the configuration file (.bin) to a specified location for future use. When you click on the “Export” button, the File Download window will pop up as shown below. Click “Save” and specify a desired location for saving the configuration file.



Upload:

To copy an existing configuration file to the IP Camera, please first click on “Browse” to select the configuration file, and then click on the “Upload” button for uploading.

NOTE: The cameras need to have the same software version to upload the configuration file.

10. Streaming Settings

10.1. Video Format

Video Resolution :

Under the Video Resolution section, the available video resolution formats include MJPEG and H.264.

GRUNDIG

> Streaming
Video Format
Video Compression
Video ROI
Video OCX Protocol
Video Frame Rate
Video Mask
Audio
< Back

Video Format

Video Resolution :
H.264 + H.264
Format 1 : 1920 x 1080 (25 fps) H-264-1
Format 2 : 720 x 576 (25 fps) H-264-2
BNC support : Yes
Save

Note :
Image attachment by FTP or E-mail will be available only while MJPEG streaming is selected.

Text Overlay Settings :
 Include date Include time
 Include text string:
Text color : black Text background color : transparent
Save

Video Rotation Type :
Normal video
Save

GOV Settings :
H.264-1 GOV Length : 60 H.264-2 GOV Length : 60
H.264-3 GOV Length : 30 H.264-4 GOV Length : 30
Save

H.264 Profile :
H.264-1 : Main profile H.264-2 : Main profile
H.264-3 : Main profile H.264-4 : Main profile

Click on "Save" to confirm the setting.

Text Overlay Settings :

Users can select these items to display data (date/time/text) on the live video pane. The maximum length of the string is 18 alphanumeric characters.

Click "Save" to confirm the Text Overlay setting.

Video Rotation Type :

Users can change the video display type if necessary. The selectable video rotation types include Normal video, Flip video, Mirror video and 180 degree rotation. Differences between these types are illustrated below.

Suppose the displayed image of IP Camera is shown as the figure below.



To rotate the image, users can select “Flip video”, for instance. Then the displayed image will be reversed as shown below.



The following are descriptions of different video rotation types.

- Flip video:

If you select <Flip video>, the image will be rotated horizontally.

- Mirror video:

If you select <Mirror video>, the image will be rotated vertically.

- 180 degree rotation:

Selecting the <180 degree rotation> will inverse the image 180° counter-/clockwise.

Click “Save” to confirm the setting.

GOV Settings :

Users can set the GOV length to determine the frame structure (I-frames and P-frames) in a video stream for saving bandwidth. Longer GOV means decreasing the frequency of I-frames. The setting range for the GOV length is from 2 to 64. The default setting of GOV is 60 which means there is one I-frame every 60 seconds. The default value for H.264-1/ H.264-2/ H.264-3/ H.264-4 is 60/ 60/ 30/ 30.

Click “Save” to confirm the GOV setting.

This camera provides three H.264 streaming formats to meet the requirements from viewing devices, the surveillance system, and the network condition of the application and installation environment. Users can set each H.264 Profile to <Baseline Profile>, <Main Profile> or <High Profile> according to the compression needs. With the same bit rate, the higher the compression ratio, the better the image quality is. The default setting is <Main Profile>.

H.264 Baseline profile: Standard Efficiency Encoding Format

H.264 Main profile: Good Efficiency Encoding Format

H.264 High profile: High Efficiency Encoding Format

10.2. Video Compression

Users can specify the values for MJPEG/H.264 compression mode in the video compression page (see the picture below), depending on the application.

MJPEG compression setting (MJPEG Q (Quality) factor):

A higher value implies higher bit rates and a higher visual quality. The default setting is 35; the setting range is from 1 to 70.

Click "Save" to confirm the setting.

H.264-1 / H.264-2 / H.264-3 / H.264-4 bit rate:

The default setting of H.264-1 is 4096 kbps and of H.264-2/H.264-3/H.264-4 is 1024 kbps. The setting range for H.264-1 is from 64 to 8192 kbps and for H.264-2/H.264-3/H.264-4 it is from 64 to 2048 kbps.

Click "Save" to confirm the setting.

The screenshot shows the GRUNDIG Video Compression settings page. The sidebar on the left includes: > Streaming, Video Format, Video Compression, Video ROI, Video OCX Protocol, Video Frame Rate, Video Mask, Audio, and < Back. The main content area is titled 'Video Compression' and contains the following sections:

- MJPEG Compression setting :** MJPEG Q factor : 35 [Save]
- H.264-1 Compression setting :** H264-1 bit rate : 4096 kbit/s [Save]
- H.264-2 Compression setting :** H264-2 bit rate : 1024 kbit/s [Save]
- H.264-3 Compression setting :** H264-3 bit rate : 1024 kbit/s [Save]
- H.264-4 Compression setting :** H264-4 bit rate : 1024 kbit/s [Save]
- Compression information setting :** Display compression information in the home page [Save]
- CBR mode setting :** enable H.264-1 CBR mode, enable H.264-2 CBR mode, enable H.264-3 CBR mode, enable H.264-4 CBR mode [Save]

Compression information setting :

Users can also decide whether to display compression information on the Home page.

Click "Save" to confirm the setting.

CBR mode setting :

The CBR (Constant Bit Rate) mode can become the preferred bit rate mode if the available bandwidth is limited. It is important to take into account the image quality when you choose to use CBR mode.

Click on "Save" to confirm the setting.

10.3. Video OCX Protocol

In the Video OCX protocol setting page, users can select RTP over UDP, RTP over TCP, RTSP over HTTP or MJPEG over HTTP, for streaming media over the network. In the case of multicast networking, users can select the Multicast mode. The Video OCX Protocol page is as follows:

Video OCX protocol setting options include:

- RTP over UDP / RTP over RTSP (TCP) / RTSP over HTTP / MJPEG over HTTP
(Select a mode according to your data delivery requirements.)

- Multicast Mode:

Enter all required data, including multicast IP address, H.264 video port, MJPEG video port, audio port and TTL into each blank.

Click on “Save” to confirm the setting.

10.4. Video ROI

The "Video ROI" setting can be found under this path: "Streaming" > "Video ROI".

ROI stands for Region of Interest. This function allows the users to select a specific monitoring region for H.264-2, H.264-3, H.264-4 and MJPEG streams, instead of showing the full image.

NOTE: This function is only available when triple streams or above is selected under <Video Resolution> in the "Video Format" Setting.

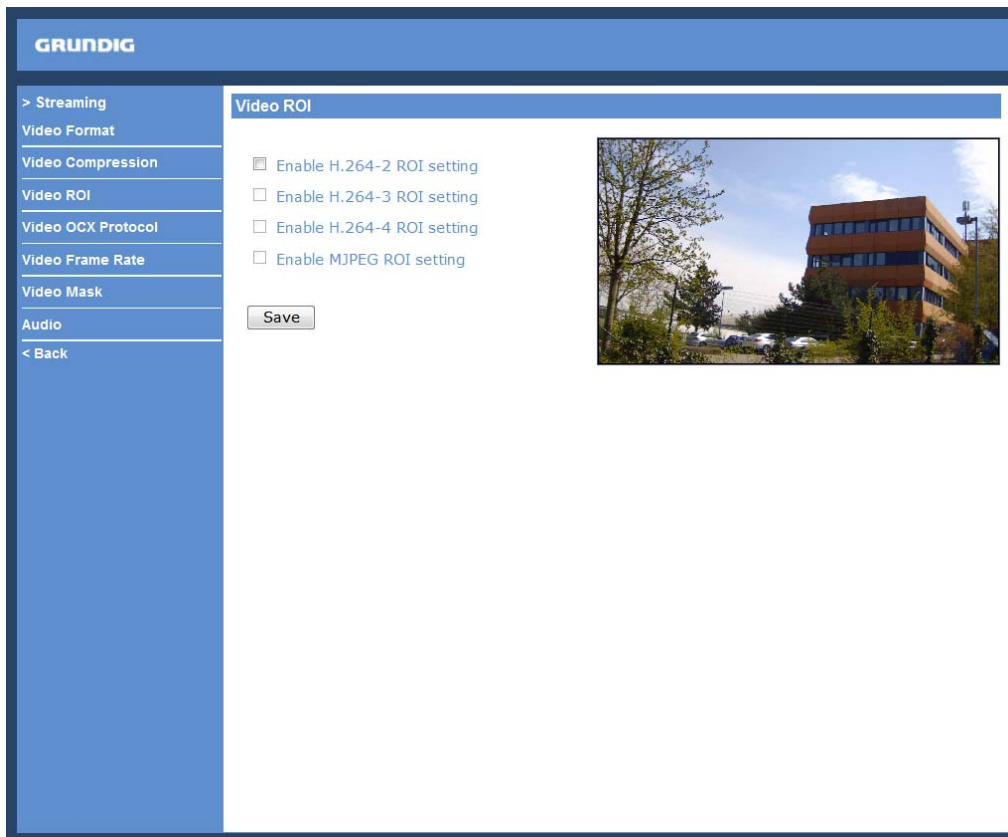

Video ROI Setting:

- Enable the H.264-2 ROI Setting:

When you check the box, H.264-2 ROI Window will be displayed. To change the size of the H.264-2 ROI Window, move the mouse cursor to the edge of the frame and draw it outward / inward. Moving the mouse to the center of the frame can shift the frame to the intended location.

NOTE: The H.264-2 ROI setting is only available when at least H.264 + H.264 + H.264 (triple stream) is selected under <Video Resolution> in the Video Format Setting.

- Enable the H.264-3 ROI Setting:

When you check the box, the H.264-3 ROI Window will be displayed. To change the size of the H.264-3 ROI Window, move the mouse cursor to the edge of the frame and draw it outward / inward. Moving the mouse to the center of the frame can shift the frame to the intended location.

NOTE: The H.264-3 ROI setting is only available when at least H.264 + H.264 + H.264 (triple stream) is selected under <Video Resolution> in the Video Format Setting.

- Enable the H.264-4 ROI Setting:

When you check the box, the H.264-4 ROI Window will be displayed. To change the size of the H.264-4 ROI Window, move the mouse cursor to the edge of the frame and draw it outward / inward. Moving the mouse to the center of the frame can shift the frame to the intended location.

NOTE: The H.264-4 ROI setting is only available when H.264 + H.264 + H.264 + H.264 is selected under <Video Resolution> in the Video Format Setting.

- Enable the MJPEG ROI Setting:

When you check the box, the MJPEG ROI Window will be displayed. To change the size of the MJPEG ROI Window, move the mouse cursor to the edge of the frame and draw it outward / inward. Moving the mouse to the center of the frame can shift the frame to the intended location.

NOTE: The MJPEG ROI setting is only available when H.264 + H.264 + H.264 + MJPEG or H.264 + H.264 + MJPEG is selected under <Video Resolution> in Video Format Setting.

10.5. Video Frame Rate

The video frame rate is for setting the frames per second (fps) if needed.

MJPEG/ H.264-1/ H.264-2 Frame Rate:

The default setting of the MJPEG Frame Rate is 25 fps; the setting range is from 1 to 25 (PAL).

Click on <Save> to confirm the setting.

NOTE: A lower frame rate will decrease the video smoothness.

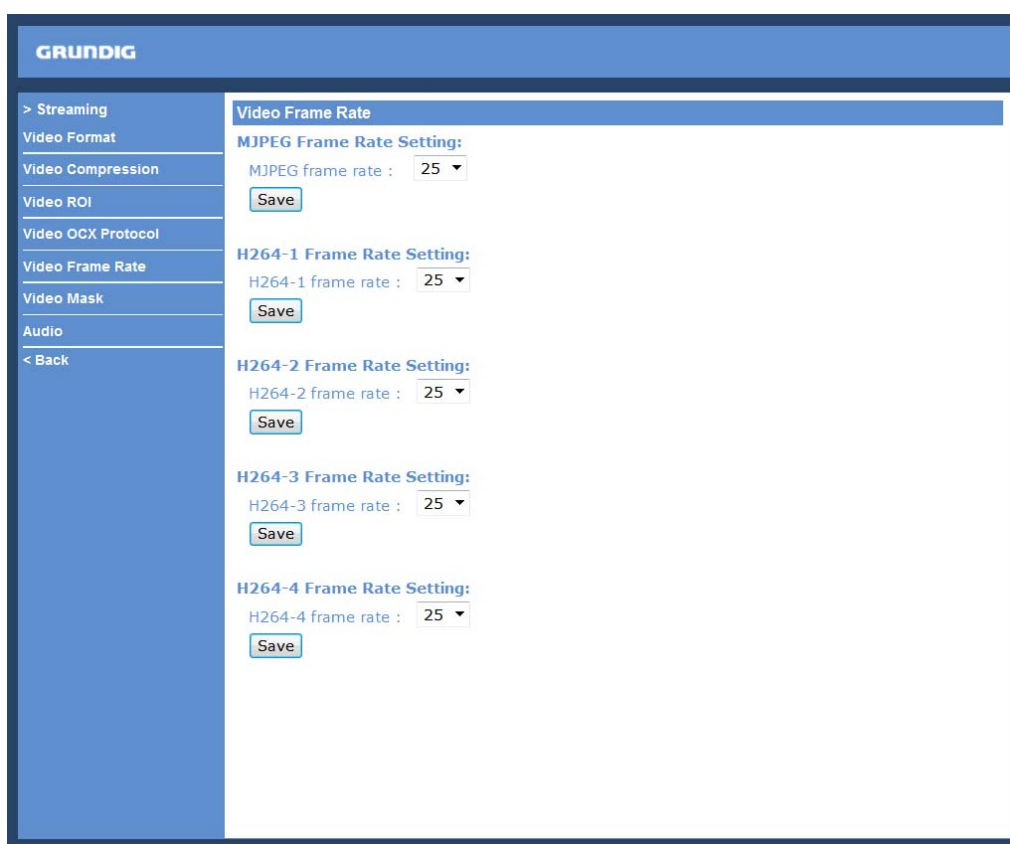

H.264-1 Frame Rate:

The default setting and setting range for H.264-1 will change according to the video format selected for the <TV system> under the <Camera> menu.

For PAL, the default setting can be 25 fps or 50 fps. 50 fps is only available when a video format with "50 fps" is selected under <TV system>. The setting range is 1 to 25 or 1 to 50.

For NTSC, the default setting can be 30 fps or 60 fps. 60 fps is only available when a video format with "60 fps" is selected under <TV system>. The setting range is 1 to 30 or 1 to 60.

MJPEG / H.264-2 / H.264-3 / H.264-4 Frame Rate:

The default setting of the MJPEG / H.264-2 / H.264-3 / H.264-4 Frame Rate is 25 fps (PAL) or 30 fps (NTSC). The setting range is from 1 to 25 (PAL) or from 1 to 30 (NTSC).

Click on <Save> to confirm the setting.

NOTE: A lower frame rate will decrease video smoothness.

10.6. Video Mask

There are five video masks which can be set by the users.

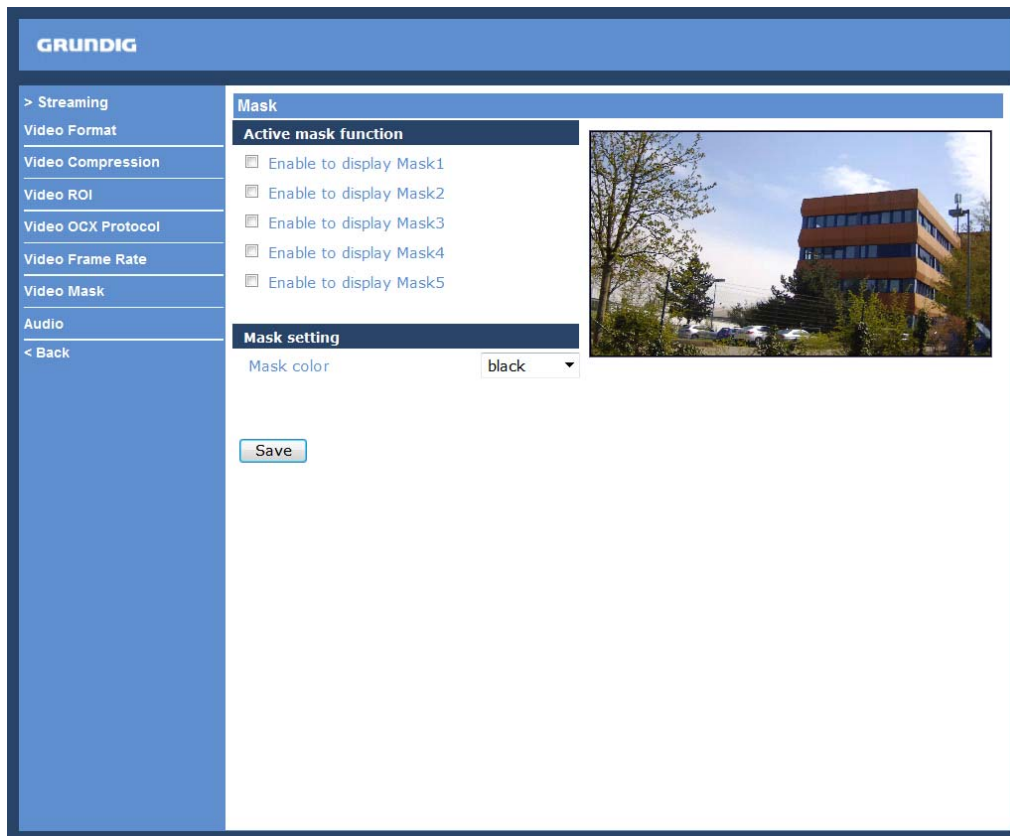

Active Mask Function :

- How to add a mask:

When you check a Video Mask checkbox ("Enable to display Mask..."), a red frame will come out in the Live Video pane at the right side. Use the mouse to adjust the mask's size and drag and drop the frame to place it on the target zone.

NOTE: It is suggested to set the Video Mask twice as big as the object.

- How to cancel a mask:

If you uncheck the checkbox of the Video Mask that is meant to be deleted, the selected mask will disappear from the Live Video pane instantly.

Mask Setting :

- Mask colour:

The selection of Mask colours includes red, black, white, yellow, green, blue, cyan, and magenta.

Click on "Save" to confirm the setting.

10.7. Audio (Audio and Bit Rate Settings)

The audio setting page is shown below. In the Audio page, the Administrator can select one transmission mode and the audio bit rate.

The screenshot shows the Grundig Audio settings interface. The left sidebar contains a navigation menu with the following items: > Streaming, Video Format, Video Compression, Video ROI, Video OCX Protocol, Video Frame Rate, Video Mask, Audio, and < Back. The main content area is titled 'Audio' and includes the following settings:

- Transmission mode:** Radio buttons for Full-duplex (Talk and listen simultaneously), Half-duplex (Talk or listen, not at the same time), Simplex (Talk only), Simplex (Listen only), and Disable (selected).
- Server gain setting:** Input gain and Output gain dropdown menus, both set to 3.
- Bit rate:** Dropdown menu set to uLAW.
- Recording to Storage:** Dropdown menu set to Disable.

Save buttons are located below the Bit rate and Recording to Storage sections.

Transmission Mode :

- Full-duplex (Talk and Listen simultaneously):

In the Full-duplex mode, the local and remote sites can communicate with each other simultaneously, i.e. both sites can speak and be heard at the same time.

- Half-duplex (Talk or Listen, not at the same time):

In the Half-duplex mode, the local/remote site can only talk or listen to the other site at a time.

- Simplex (Talk only):

In the Talk only Simplex mode, the local/remote site can only talk to the other site.

- Simplex (Listen only):

In the Listen only Simplex mode, the local/remote site can only listen to the other site.

- Disable:

Select this item to turn the audio transmission function off.

Server Gain Setting :

Set the audio input/output gain levels for sound amplification. The audio gain values are adjustable from 1 to 6. The sound will be turned off if the audio gain is set to "Mute".

Recording to Storage :

Select <Enable> from the drop-down menu to enable the audio recording together with the videos onto an SD card.

NOTE: If the chosen bit rate is not compatible with the player, there will be no audio and noise will be heard during playback.

Bit Rate :

The selectable audio transmission bit rates include 16 Kbps (G.726), 24 Kbps (G.726), 32 Kbps (G.726), 40 Kbps (G.726), uLAW (G.711) and ALAW (G.711). Both uLAW and ALAW signify 64 Kbps but in different compression formats. A higher bit rate signifies a higher audio quality and requires a bigger bandwidth.

Click on "Save" to confirm the setting.

11. Camera Settings

The picture below is the camera configuration page. Details of each parameter setting are described in the following sub-sections.

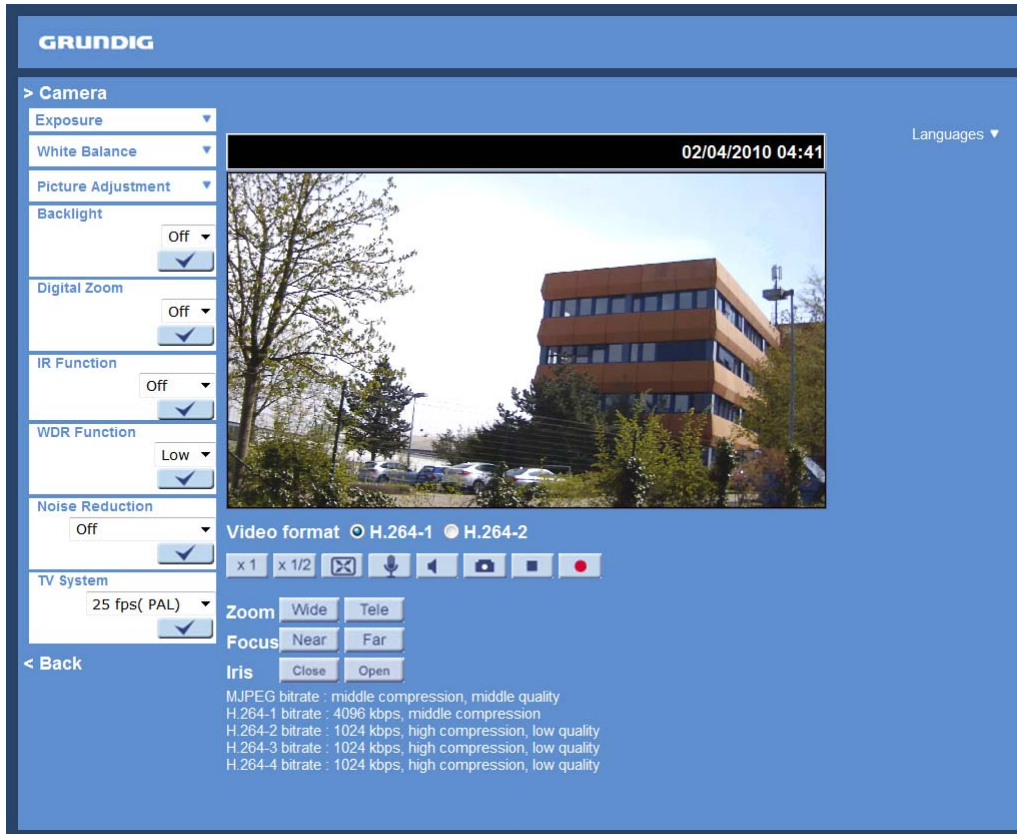

11.1. Exposure Setting

Display of the Exposure pull-down menu:

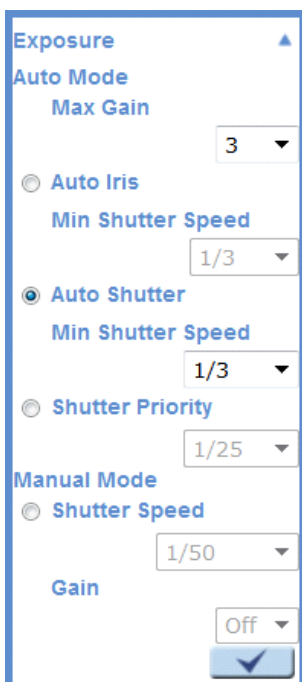

The exposure is the amount of light received by the image sensor and is determined by the width of lens diaphragm opening, the amount of exposure by the sensor (shutter speed) and other exposure parameters. With this item, users can define how the Auto Exposure function works.

Auto Mode:

- Max Gain:

The maximum gain can be set to reduce the image noises. The max gain can be set from 1 to 4. The default setting is 4.

- Auto Iris Mode:

In this mode, the exposure gives priority to the auto iris. The minimum shutter speed can be set from 1/1.5 to 1/25 sec. AGC (Auto Gain Control) will function automatically according to the light conditions of the subject.

- Auto Shutter:

This function is used to control the shutter speed and to adjust the iris automatically according to the light intensity. It is also effective if a fixed iris lens is being used. The minimum shutter speed range is configurable from 1/1.5 to 1/425 sec.

Manual Mode:

- Shutter Speed:

In this mode, a fixed shutter speed can be selected from the drop-down menu. The shutter speed range is from 1/10000 to 1/1.5 sec. With 18 options depending on the camera model. Users can choose a suitable shutter speed according to the environmental illumination.

- Gain:

The gain can be set from 1 to 9. The default setting is 1.

Click on < √ > to confirm the new setting.

- Shutter Priority Mode:

This function is to set the shutter speed to a specified speed. The range is configurable from 1/25 to 1/425 sec.

11.2. White Balance Setting

Display of the White Balance pull-down menu:

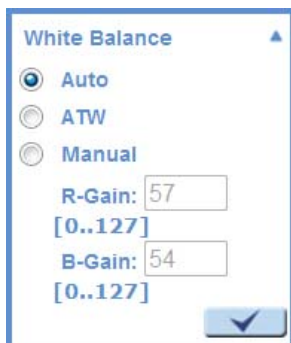

To display natural colours, the camera needs to know the reference colour temperature of the light source. Based on this reference colour temperature the camera will calculate the correct values for all colours. The camera can perform a measurement by itself or the user can set up the reference colour temperature manually. The scale unit of the colour temperature is Kelvin [K]. The following list shows the colour temperature of some light sources for reference.

The users can select one of the White Balance Control modes according to the operating environment.

Light Sources :

Cloudy Sky (Colour Temperature: 6,000 to 8,000 K)

Noon Sun and Clear Sky (Colour Temperature: 6,500 K)

Household Lighting (Colour Temperature: 2,500 to 3,000 K)

75-watt Bulb (Colour Temperature: 2,820 K)

Candle Flame (Colour Temperature: 1,200 to 1,500 K)

Auto Mode :

The Auto White Balance mode is suitable for an environment with a light source having a colour temperature range from 2700 ~ 7600K.

ATW Mode (Auto Tracking White Balance) :

With the Auto Tracking White Balance function, the white balance in a scene will be automatically adjusted while temperature colour is changing. The ATW Mode is suitable for environments with a light source having a colour temperature in the range roughly from 2450 ~ 10500K.

Manual Mode :

In this mode, users can change the White Balance value manually. Users can select a number between 0 ~ 127 in the "R-Gain/B-Gain" item to gain the red/blue illuminant on the Live Video Pane.

Click on < ✓ > to confirm the new setting.

11.3. Picture Adjustment

Display of the Picture Adjustment pull-down menu:



Brightness:

The users can adjust the image's brightness by adjusting the item. Please select a number from the range of -12 to +13. To increase the video brightness, select a bigger number.

Click on < ✓ > to confirm the new setting.

Sharpness:

Increasing the sharpness level can make the image look sharper. Please select a number from the range of +0 to +15. This function especially enhances the object's edges.

Click on < ✓ > to confirm the new setting.

Contrast:

The camera image contrast level is adjustable. Please choose from a range of -6 to +19.

Click on < ✓ > to confirm the new setting.

Saturation:

The camera image saturation level is adjustable. Please select from a range of -6 to +19.

Click on < ✓ > to confirm the new setting.

Hue:

The camera image hue level is adjustable. Please select from a range of -12 to +13.

Click on < ✓ > to confirm the new setting.

11.4. Backlight Setting

Based on various lighting situations, users can turn the function of Backlight Compensation on or off to optimise the video quality. The default value of Backlight is: Off.

Click on < ✓ > to confirm the new setting.



11.5. Digital Zoom Setting

The camera's Digital Zoom is adjustable from x2 to x8.

Click on < ✓ > to confirm the new setting.

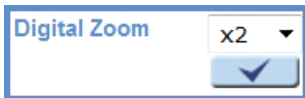

11.6. IR Function

With the IR cut filter, the Camera can still catch a clear image at night time or in low light conditions.



NOTE: The IR Function is not available for the camera GCI-K1603B.

Auto/On/Off Mode:

With the IR cut filter, the Dome Camera can still catch a clear image at night time or in low light conditions.

Smart Mode:

The Smart Mode enhances the monochrome/night mode stability in ascenario where IR illumination is dominant. In this mode, when the external IR illuminator is turned on, the IR cut filter of the IP Camera will stay open (i.e. monochrome/night mode), preventing the camera from returning to colour/day mode when the IR illumination is dominant.

Click on < ✓ > to confirm the new setting.

11.7. WDR Function

The Wide Dynamic Range (WDR) function is for solving high contrast or changing light issues to improve the video display. The WDR is adjustable from Low, Mid to Hi. A higher level of WDR represents a wider dynamic range, so that the IP Camera can catch a greater scale of brightness.

Click on < ✓ > to confirm the new setting.



11.8. Noise Reduction

The IP Camera provides multiple <Noise Reduction> options for delivering an optimised image quality especially in extra low-light conditions.

The different level options for 3D Noise Reduction (3DNR) include Low, Mid and Hi. A higher level of 3DNR generates relatively enhanced noise reduction.

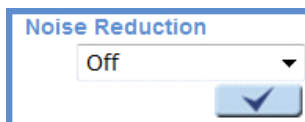

The proprietary Smart Picture Quality (SPQ) video processing method can drastically minimise motion blur and reduce the noise especially in a low-light environment. The combination of SPQ and 3DNR at different levels further yields exceptional video performance in various conditions.

The Noise Reduction function is configurable with the following options:

- 3DNR Low
- 3DNR Mid
- 3DNR Hi
- SPQ
- SPQ + 3DNR Low
- SPQ + 3DNR Mid
- SPQ + 3DNR Hi

Click on < ✓ > to confirm the new setting.

11.9. TV System Setup

Select the video format that matches the present TV system.

Click on < ✓ > to confirm the new setting.

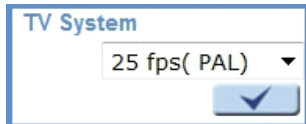

12. Pan/Tilt

The camera models GCI-K1503B and GCI-K0509B have a RS-485 Interface. This chapter is referring to the "Pan/Tilt" menu of these specific camera models.

With RS-485 support, this IP camera type is capable of working with a Pan Tilt Head for pan and tilt control. Before implementing pan/tilt control, please ensure that the Pan & Tilt Head is correctly connected to the IP Camera's RS-485 port.

Pin Definition for the RS-485 Port of this IP camera type:

- PIN 1: Output+
- PIN 2: Output-
- PIN 3: Input+
- PIN 4: Input-
- PIN 5: GND
- PIN 6: D-
- PIN 7: D+

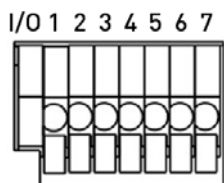

Press "Pan / Tilt" on the left side of the Main menu page, and the configurable Pan/Tilt settings will be displayed in the left column. Further details of these settings will be specified in the following sections.

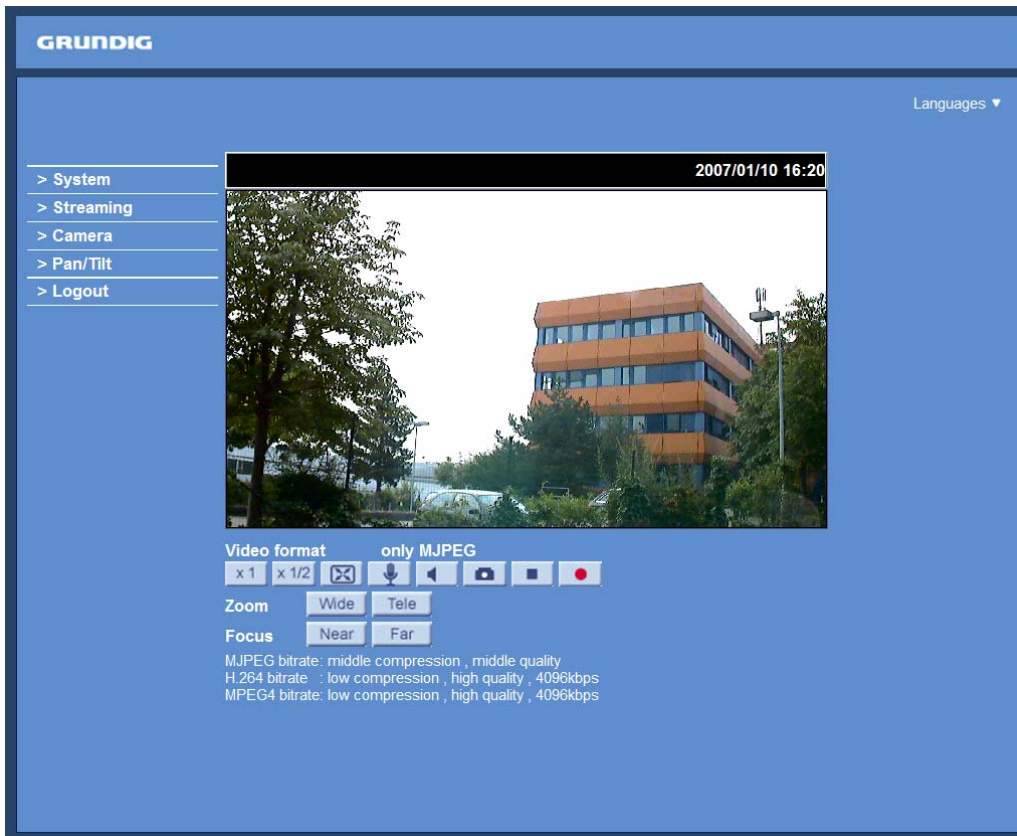

12.1. Preset

Before setting this function, users must enable the Pan/Tilt Control first. Please refer to section 12.3. Pan/Tilt Control for more details.

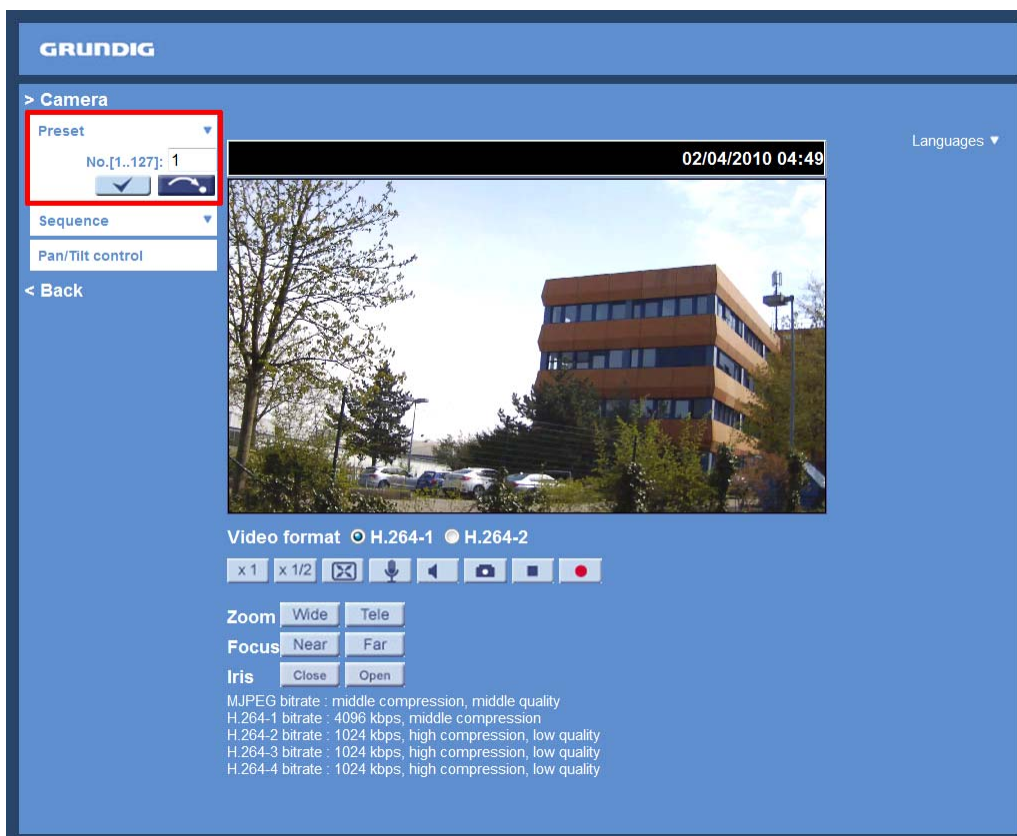

There are up to 127 preset points that can be set in the Preset setup page. Please follow the steps below to set and run the preset points.

Preset Points Setup:

Step 1: Move the camera to the desired position by moving the mouse cursor onto the screen, click on the left mouse button, hold it and drag the red arrow to pan/tilt the camera. Users may adjust the zoom position as well.

Step 2: Once a Preset Point is defined, please assign a number (between 1 and 127) to it and enter this number into the input field.

Step 3: Click on the < ✓ > button to save the defined preset point.

Preset Run:

Type in the Preset Point number into the Preset field, click on the arrow/point button, and the camera will turn to this Preset Point.

12.2. Sequence

The Sequence function supports in total eight Sequences; each Sequence consists of up to 64 Preset Points. Please refer to the instructions below to program a Sequence.

Preset	Name	Dwell time	Preset	Name	Dwell time
1.	-- no setting --		17.	-- no setting --	
2.	-- no setting --		18.	-- no setting --	
3.	-- no setting --		19.	-- no setting --	
4.	-- no setting --		20.	-- no setting --	
5.	-- no setting --		21.	-- no setting --	
6.	-- no setting --		22.	-- no setting --	
7.	-- no setting --		23.	-- no setting --	
8.	-- no setting --		24.	-- no setting --	
9.	-- no setting --		25.	-- no setting --	
10.	-- no setting --		26.	-- no setting --	
11.	-- no setting --		27.	-- no setting --	
12.	-- no setting --		28.	-- no setting --	
13.	-- no setting --		29.	-- no setting --	
14.	-- no setting --		30.	-- no setting --	
15.	-- no setting --		31.	-- no setting --	
16.	-- no setting --		32.	-- no setting --	

NOTE: Before setting this function, users must pre-define at least two Preset Points.

Sequence Setting:

- Sequence No.:

Please select a number for the Sequence to be set from the drop-down list.

- Sequential Preset Points Setting:

Please set up each Preset Point of the programmed Sequence in order, assigning a Preset Point from the "Name" list to the specified number of Preset Point and entering the Dwell Time (0~255 sec.) into the corresponding field.

- Sequential Reset:

To reset the sequence setting of each line, please press the "Reset" button in the top right corner of the setup page. Then press the < ✓ > button on the left to refresh the page in order to enter the new settings.

When finishing the sequential Preset Points setting, please click on the button "Save" in the top right corner of the Sequence setting menu.

Sequence Run:

Select the specified Sequence No. from the drop-down list and press the arrow/point button. Then the camera will start moving forward by each scene sequentially as programmed.

To view the camera executing a Sequence in full screen mode, please move the mouse cursor onto the live view pane, right-click and left-click to select "fullscreen". Then users can view the camera navigation in full screen.

To stop running the Sequence Line, simply move the cursor to the live view pane, right-click, hold the click and drag the camera in any direction.

12.3. Pan/Tilt Control

The users can activate the pan/tilt function here and select the RS-485 protocol that the Pan Tilt Head needs.

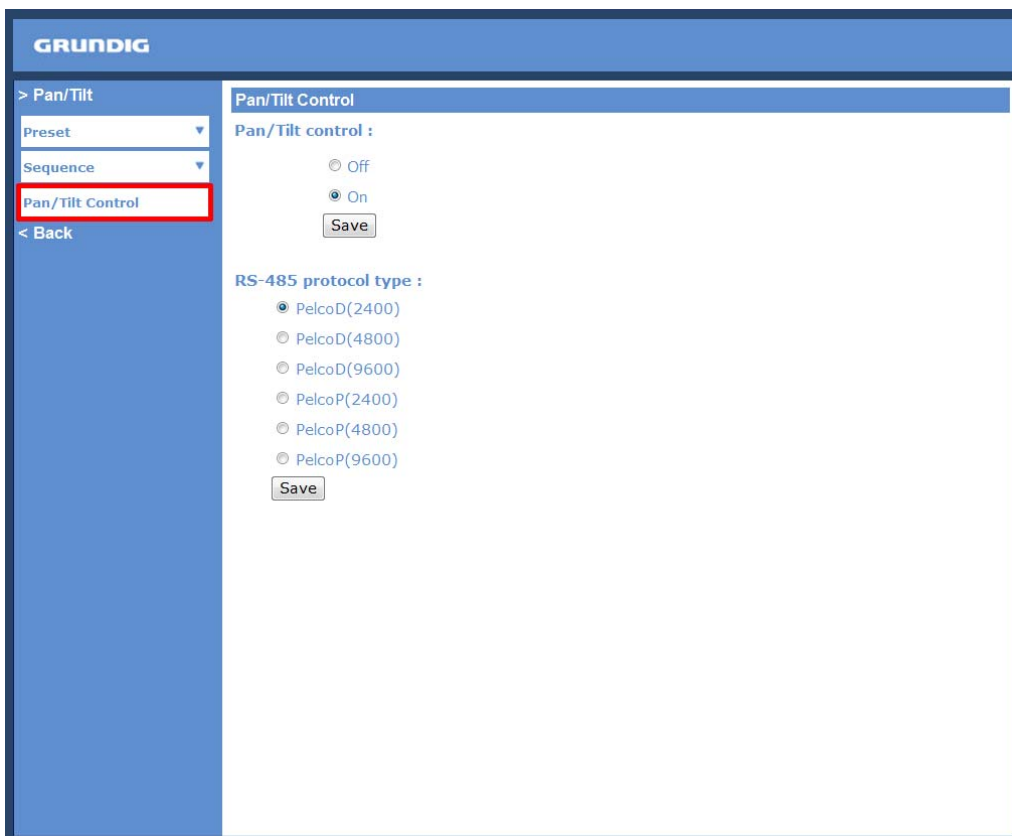

Pan/Tilt Control:

Users can enable or disable the Pan/Tilt Control.

Click "Save" to confirm the setting.

RS-485 Protocol Type:

Protocol and Baud rate type options include:

- DSCP (9600)
- PelcoD (2400)
- PelcoD (4800)
- PelcoD (9600)
- PelcoP (2400)
- PelcoP (4800)
- PelcoP (9600)

Click "Save" to confirm the setting.

Pan/Tilt Control :

Users can implement pan/tilt control by first moving the cursor to the live video pane; then left-click, hold the click and drag the pointer in any direction.

13. Logout

When you press the “Logout” tab at the top of the page, the login window will pop up. This permits login with another user name.

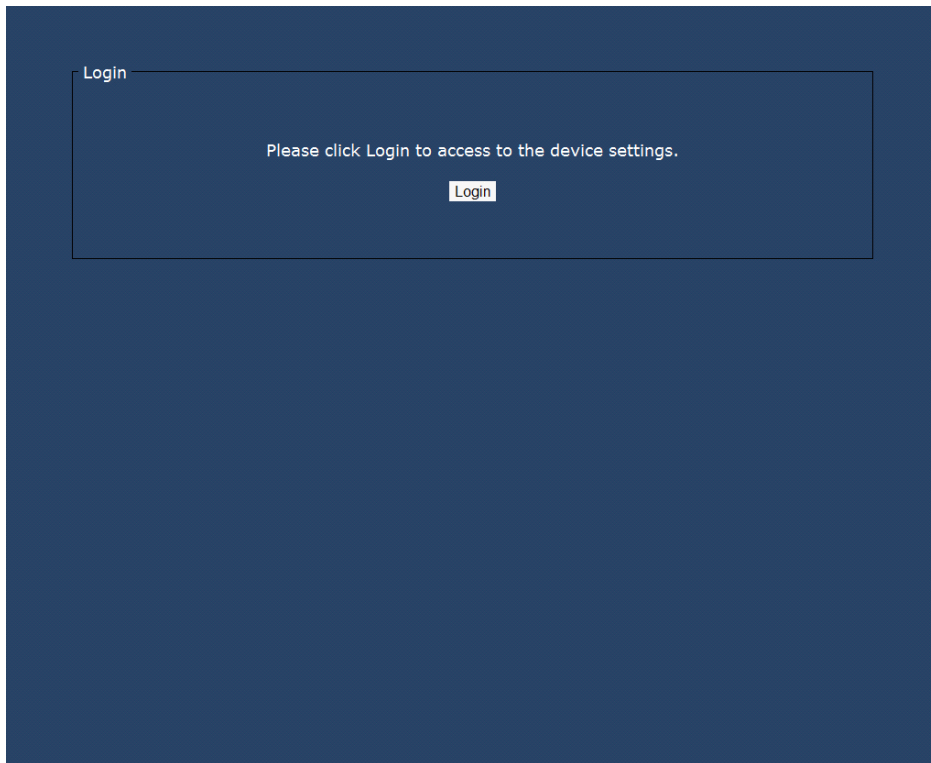

14. CMS Software Introduction

The Central Management System (CMS) software bundles IP cameras and analogue cameras that are connected to the network via the Video Server into one system. Offering powerful functionalities via intuitive interface, it is a centralised monitoring solution for your video surveillance equipments.

The GRUNDIG CMS Software gives the user access to monitor multiple IP Cameras and Video Servers, and allows the user to monitor simultaneously 16 sites per group (up to 10 groups) within several clicks.

For further information on the CMS software, please refer to the supplied CD.

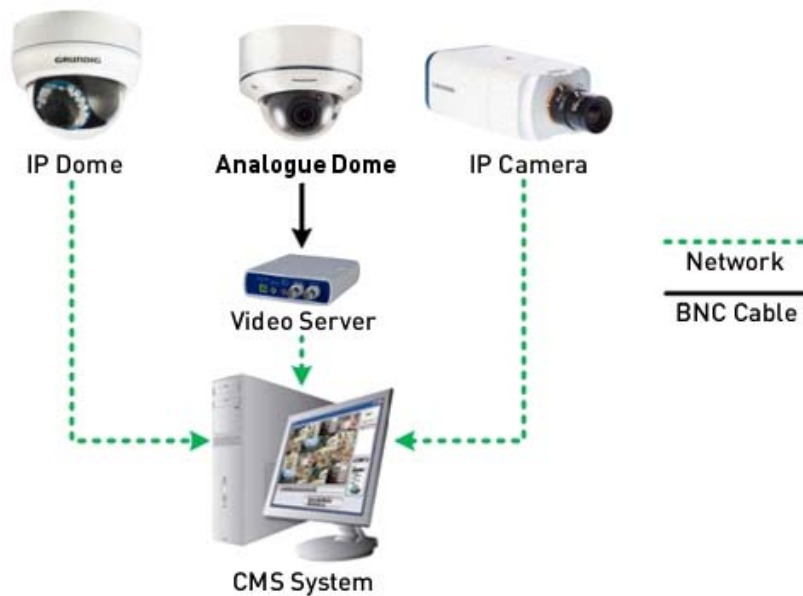

15. Internet Security Settings

If the ActiveX control installation is blocked, please either set the Internet security level to default or change ActiveX controls and plug-in settings.

Internet Security Level : Default

Step 1: Start the Internet Explorer.

Step 2: Select <Tools> from the main menu of the browser. Then click on <Internet Options>.

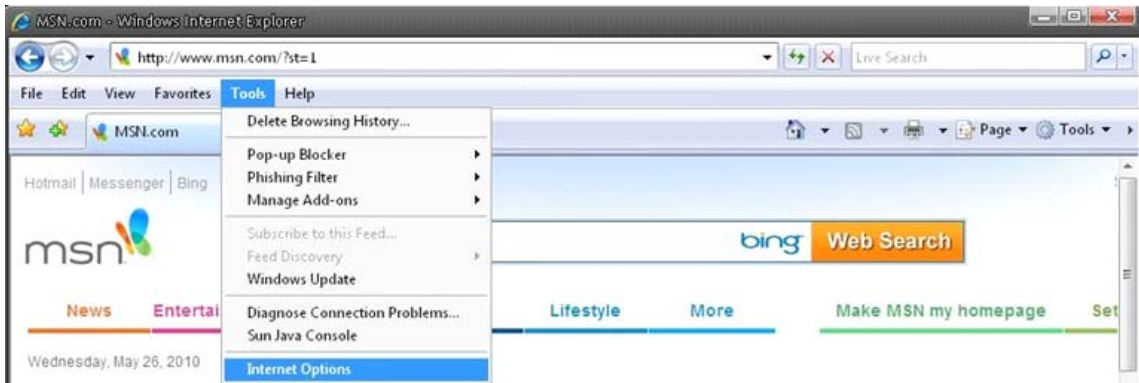

Step 3: Click on the <Security> tab, and select <Internet>.

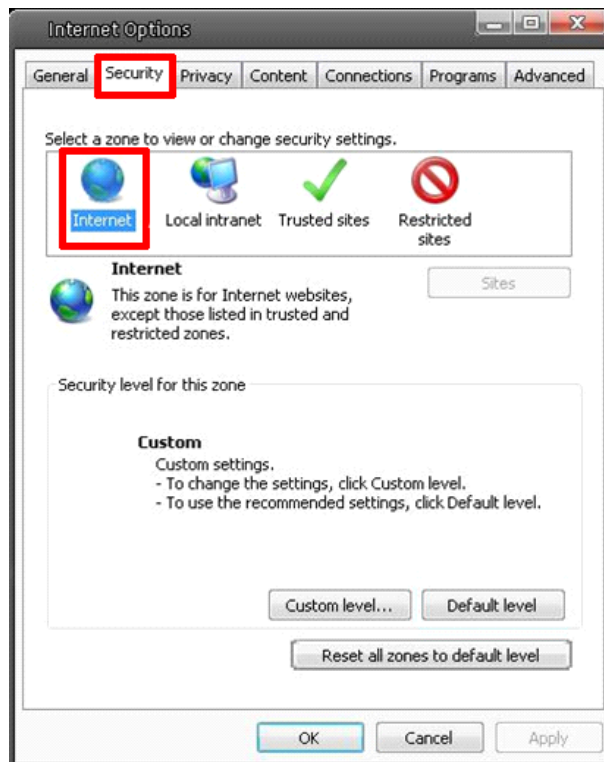

Step 4: Down the page, click on “Default level...” and then click “OK” to confirm the setting. Close the browser window, and open a new one later when accessing the IP Camera.

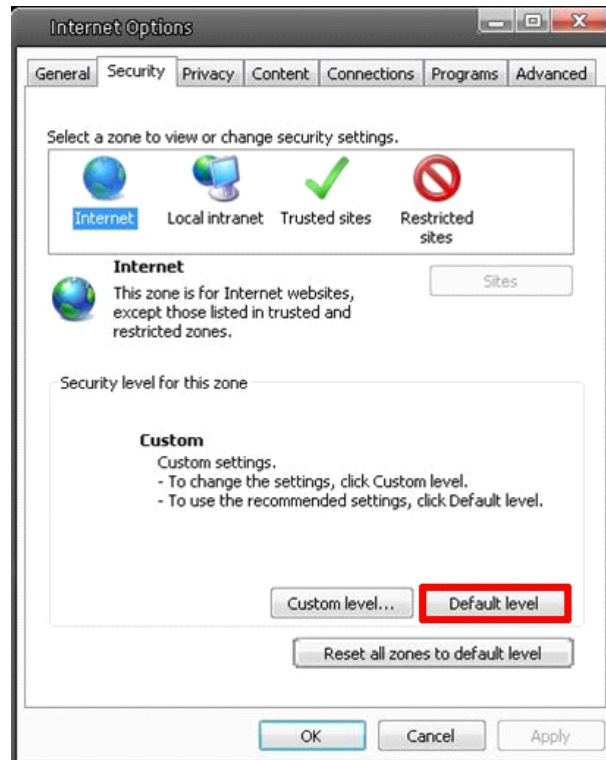

ActiveX Controls and Plug-in Settings :

Step 1~3: Please refer to the previous section above.

Step 4: Down the page, click on “Custom level...” (see the picture below) to change ActiveX controls and plug-in settings.



The Security Settings screen is displayed as shown below:

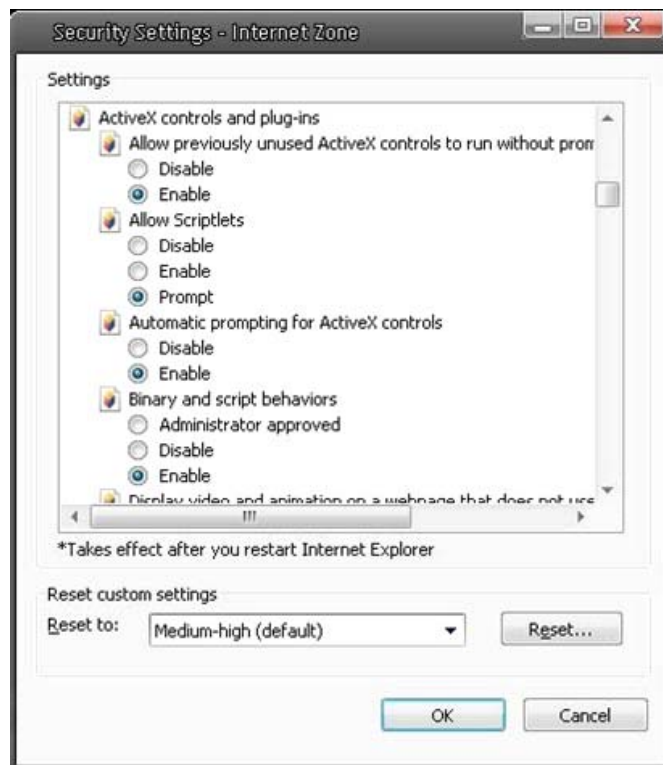

Step 5: Under “ActiveX controls and plug-ins”, set ALL items (as listed below) to <Enable> or <Prompt>. Please note that the items may vary depending on the Internet Explorer version you are using.

ActiveX controls and plug-in settings:

1. Allow previously unused ActiveX controls to run without prompt
2. Allow Scriptlets
3. Automatic prompting for ActiveX controls
4. Binary and script behaviors
5. Display video and animation on a webpage that does not use external media player
6. Download signed ActiveX controls
7. Download unsigned ActiveX controls
8. Initialize and script ActiveX controls not marked as safe for scripting
9. Run ActiveX controls and plug-ins
10. Script ActiveX controls marked as safe for scripting

Step 6: Click on <OK> to accept the settings and to close the Security screen.

Step 7: Click on <OK> to close the Internet Options screen.

Step 8: Close the browser window, and open a new one later for accessing the IP Camera.

16. GRUNDIG Viewer Download Procedure

The procedure of the GRUNDIG Viewer software download is specified as follows:

Step 1: In the GRUNDIG Viewer installation page, click “Next” to start the installation.



Step 2: Setup starts. Please wait for a while until the loading bar runs out.

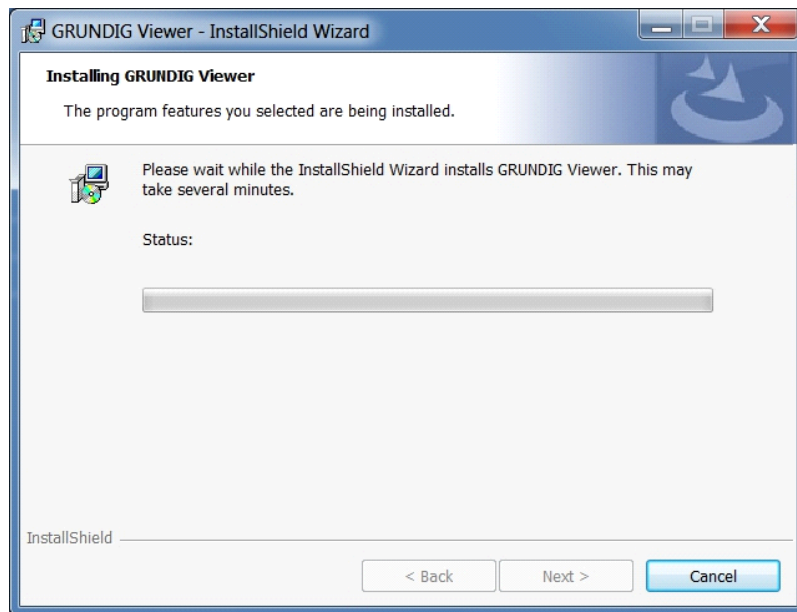

Step 3: Click on "Finish" to close the GRUNDIG Viewer installation page.



Then, the IP Camera's Home page will be displayed as follows:

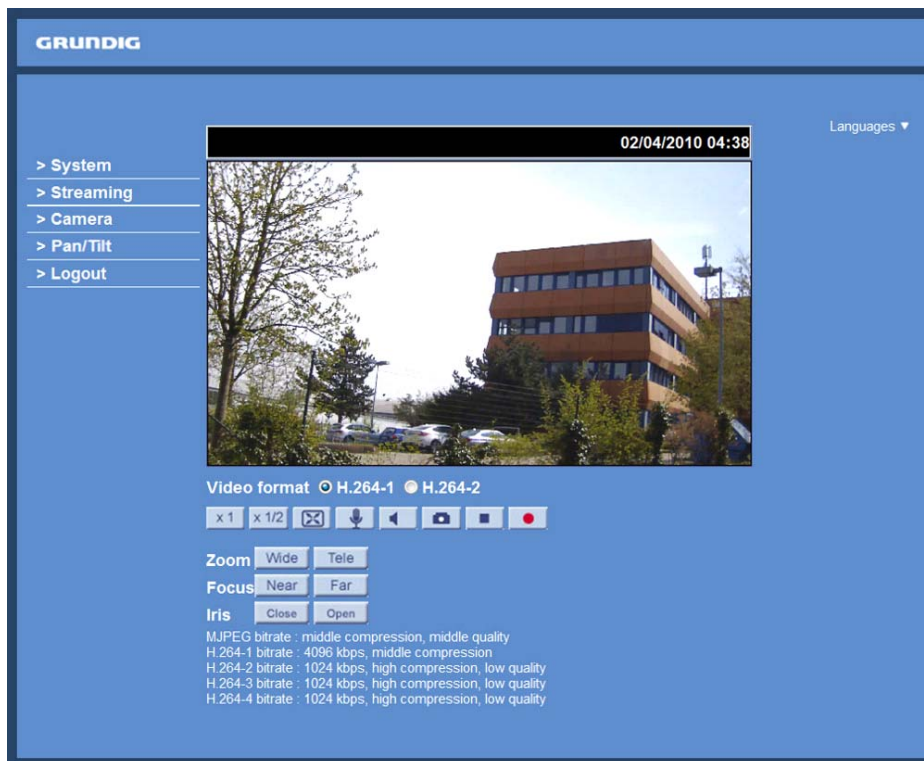

NOTE: Please note that the function buttons may vary depending on the camera model.

17. Install UPnP Components

Please follow the instructions below to install UPnP components. (The procedure is for Windows XP, for other systems please refer to the corresponding manuals.)

Step 1: Go to "Start", click on "Control Panel", and then double-click on "Add or Remove Programs".



Step 2: Click on "Add/Remove Windows Components" in the Add or Remove Programs page.

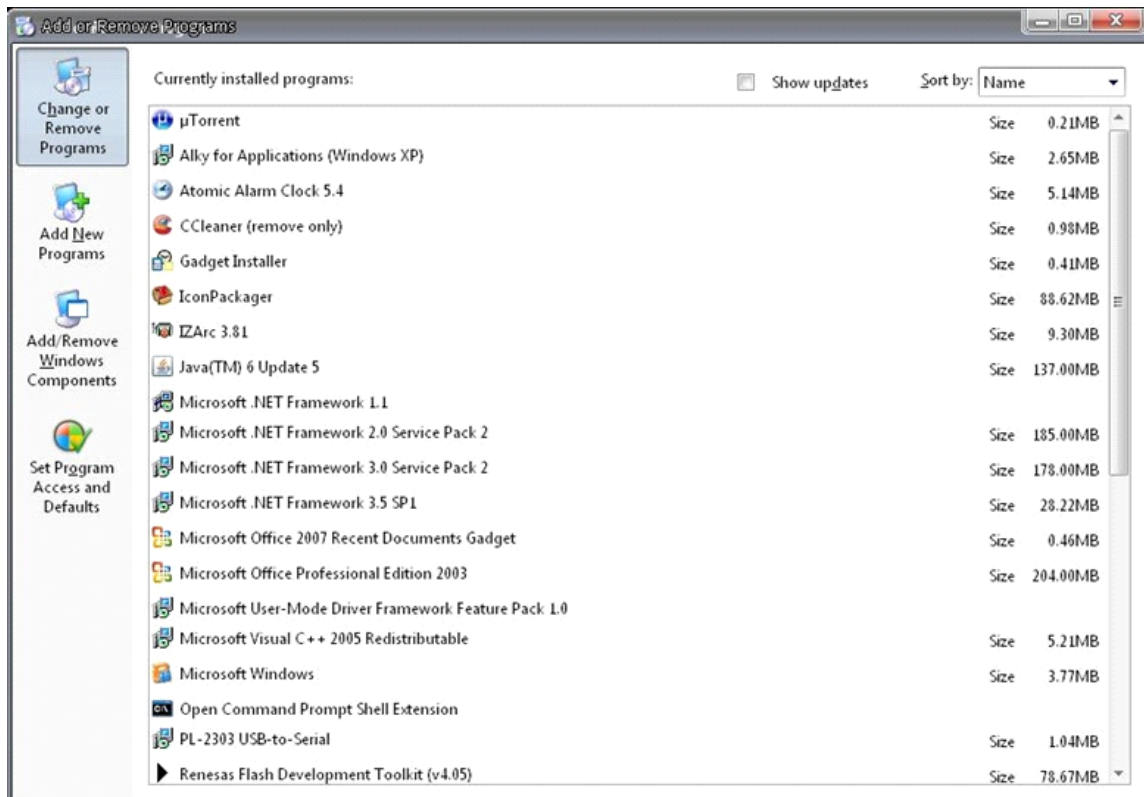

Step 3: Select "Networking Services" from the Components list in the Windows Components Wizard window, and then click on "Details".

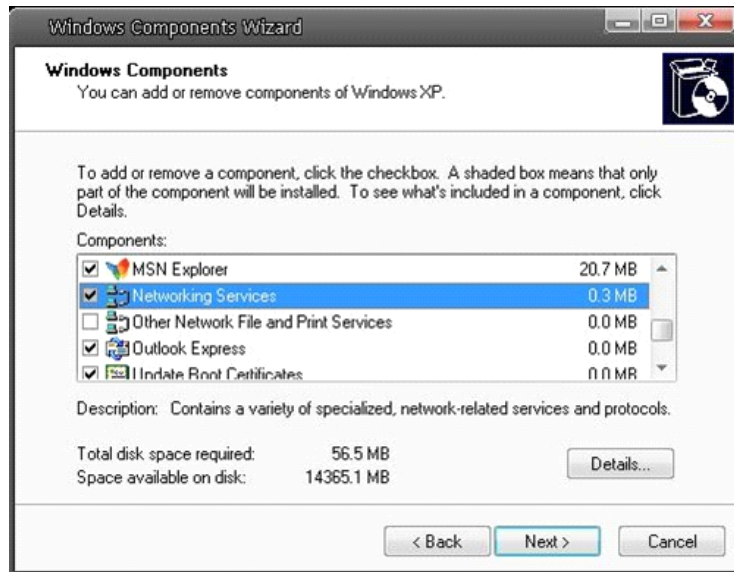

Step 4: Select "UPnP User Interface" in the Networking Services' subcomponents list and then click on "OK".

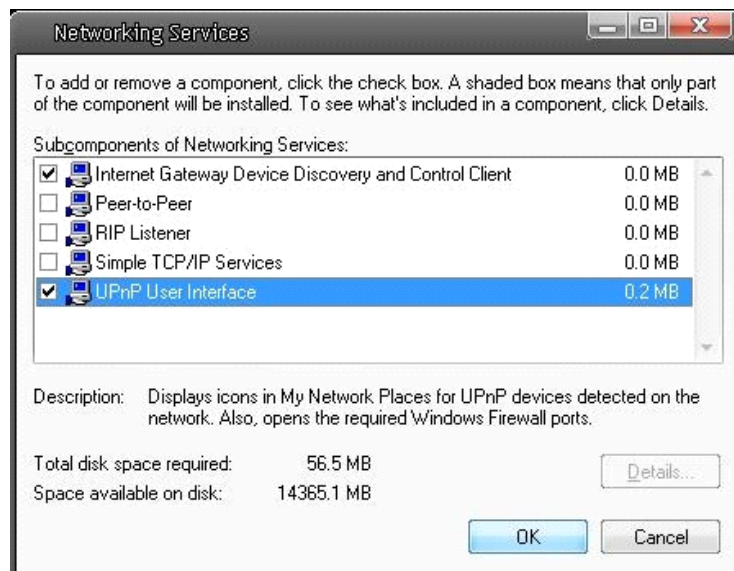

Step 5: Click on "Next" in the Windows Components Wizard page.

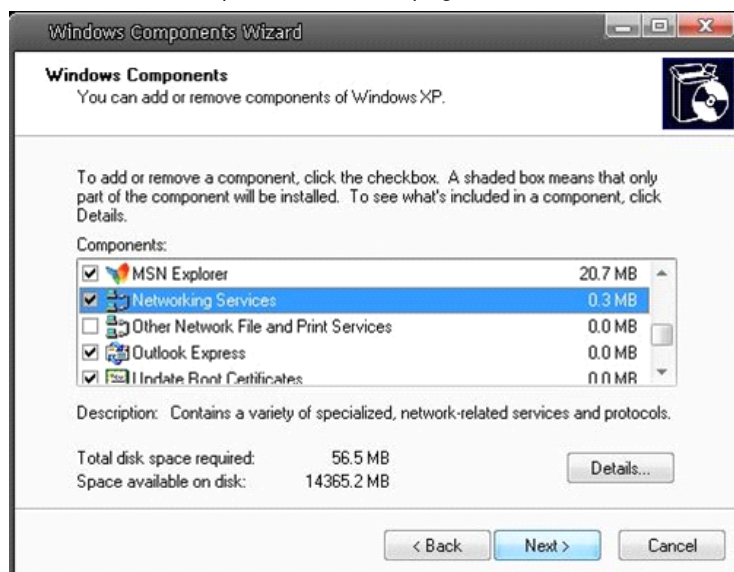

Step 6: Click on "Finish" to complete the installation.



18. Deleting the Existing GRUNDIG Viewer

Users who have installed the GRUNDIG Viewer for 1.3 Megapixel Series IP Cameras on the PC need to delete the existing GRUNDIG Viewer first from the PC before accessing this IP Camera.

Deleting the GRUNDIG Viewer :

Click on "Control Panel", and then click on "Add or Remove Programs". In the "Currently installed programs" list, select "GRUNDIG Viewer" and click the button "Remove" to uninstall the existing GRUNDIG Viewer as shown in the figure below.

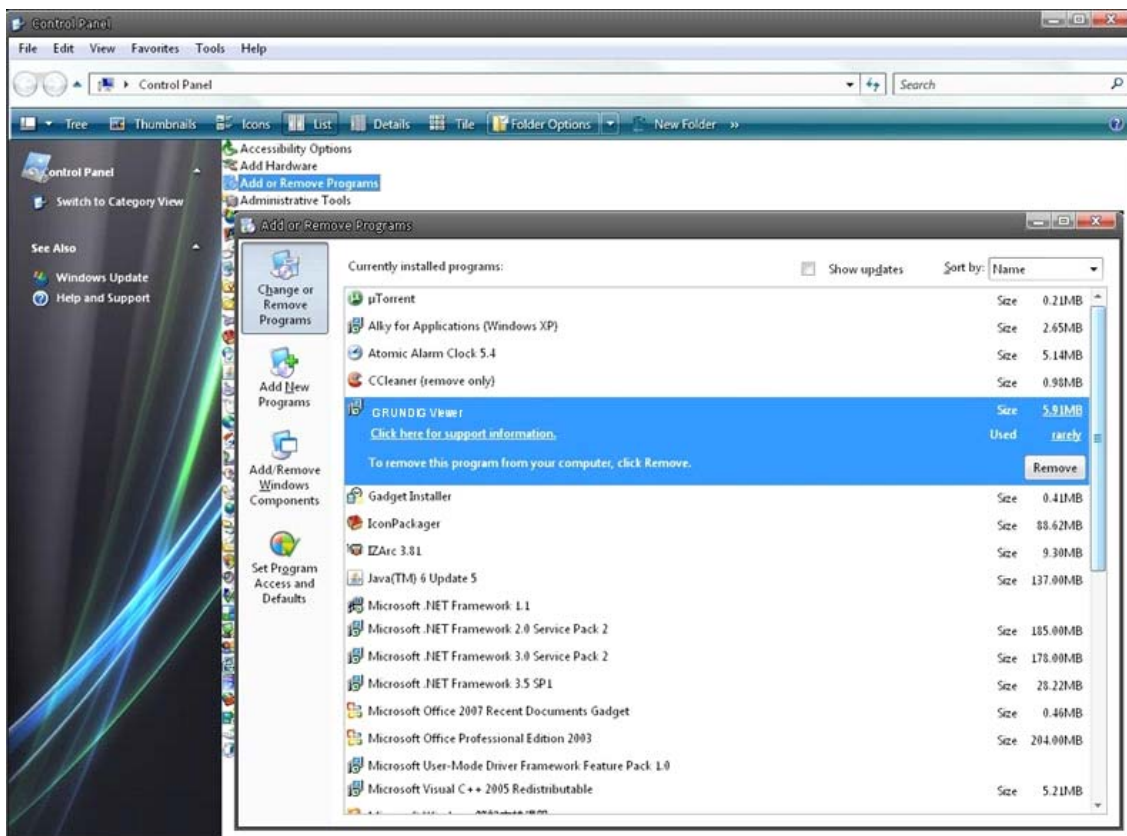

Deleting Temporary Internet Files :

To improve the browser performance, it is suggested to clean up all the files in the Temporary Internet Files. The procedure is as follows (for other web browsers please read the corresponding manuals):

STEP 1: Click on the "Tools" tab and select the option "Internet Options".

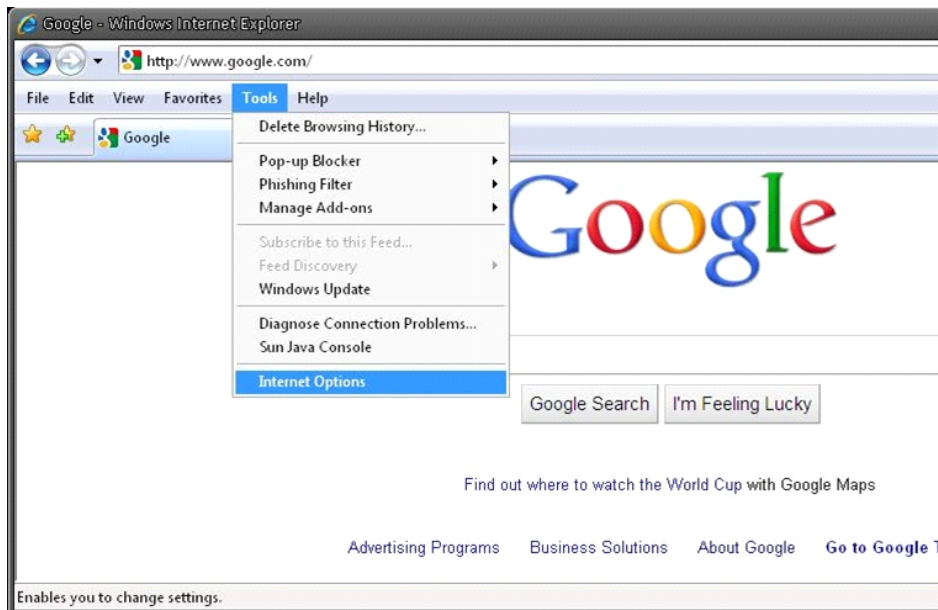

STEP 2: Click on "Delete" in the first pop-up window. Then tap "Delete Files" in the "Temporary Internet files" section in the next pop-up window.

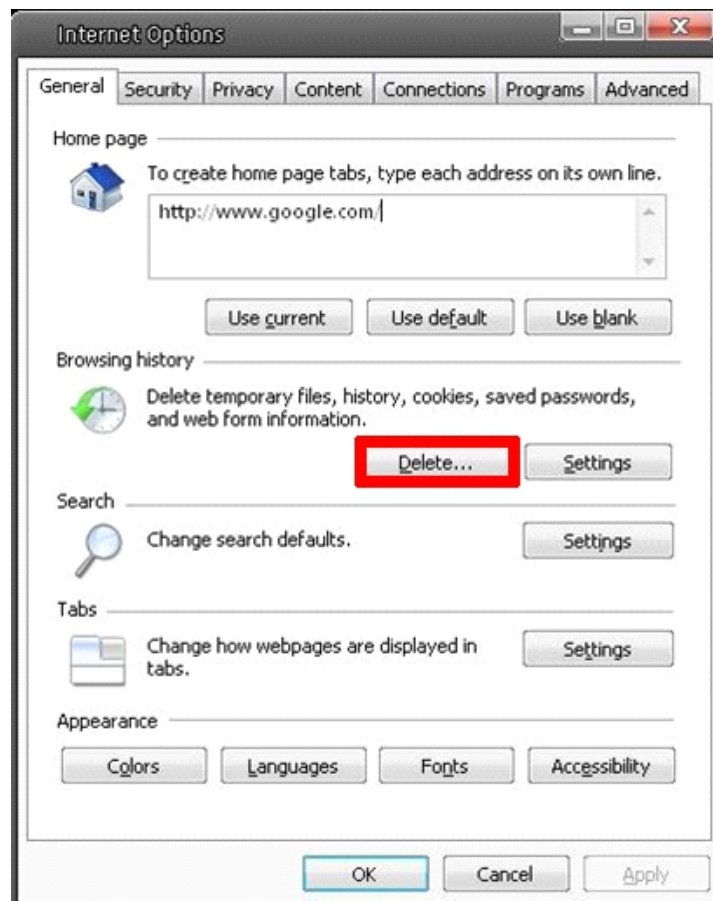



19. Back Focus Adjustment

When to adjust the back focus:

Back Focus refers to the distance from the rear lens element to the camera focal plane. It is only required to adjust the back focus only when the focus cannot be adjusted throughout its zoom range.

Requirements:

Tools required when carrying out back focus adjustment include:

1. Test chart / contrasting object
2. Allen Key (depending on the camera model)

How to adjust the back focus:

Step 1: Set the camera on a stable mount, with the test chart or object at least 75 feet (23 meters) away (or as far as possible). Please loosen the Back Focus Retaining Screw by hand or with the supplied Allen Key (depending on the camera model).



Step 2: Make sure the iris is wide open. Therefore, it is advised to keep the environment in low light condition. To open the automatic lens completely, please use a neutral density filter. With this filter it is possible to simulate a low light condition so that the lens can open up completely.

Step 3: Adjust the focus to infinite far (∞).

Step 4: Turn the zoom to the wide angle position, and then focus with the back focus adjustment on the test chart.

Step 5: Set the zoom now to the most extreme telephoto position.

Step 6: Focus on the object with the focus screw of the lens (not with the back focus adjustment!). If this procedure is successful, the back focus adjustment is finished and you can continue with step 8. If it was not successful, please carry on with Step 7.

Step 7: Repeat steps 3 ~ 6 until the focus can be adjusted throughout the zoom range. When using a zoom lens, the focus does not need to be adjusted again once the back focus adjustment has been completed. This does not apply to vario lenses.

Step 8: Tighten the back focus ring's retaining screw to fix the back focus adjustment.

Specifications GCI-K1503B

Image Sensor	1/2.7" CMOS, 2 Megapixel
Pixels - Total	1920(H) x 1080(V)
Col/B&W	On/Off/Auto, IR-cut filter removable (ICR)
Sensitivity Colour	0.5 Lux@F1.2 (IRE50), 0.2 Lux@F1.2 (IRE30)
Sensitivity B&W	0.1 Lux@F1.2 (IRE50), 0.02 Lux@ F1.2 (IRE30)
Lens Mount	C/CS mount with adaptor
Lens Drive Type	Auto iris (DC)
Shutter Speed	1 sec to 1/10,000 sec
WDR	D-WDR (Digital wide dynamic range)
BLC	On/Off
Digital Noise Reduction (DNR)	On/off 2D/3D Noise Filter
Motion Detection	On/ Off/ Sensitivity/ Area setting
Tampering Alarm	On/Off
Privacy zones	5 zones, rectangle
White Balance	ATW, AWB, Manual
Digital Zoom	Yes
Camera ID	20 characters
Alarm Inputs	1
Alarm Outputs	1
Web Browser	MS Internet Explorer 6.0 (or higher), Firefox, Google Chrome, Safari
Number of Clients	Up to 20 user
Video Compression	H.264, MJPEG
Video Resolution	1920x1080p(25fps), 1280x1024(25fps), 1280x720(25fps), 1024x768(25fps),etc.
Video Streaming	Quad stream: max.: H.264+H.264+H.264+H.264 or H.264+H.264+H.264+MJPEG
Network Protocol	IPv4/v6, TCP/IP, UDP, RTP, RTSP, HTTP, HTTPS, DHCP, PPPoE, UPnP, SMTP, ICMP, IGMP, SNMP, IEEE802.1x, QoS, ONVIF, FTP
SD Memory	supports up to 32 GB capacity of micro SD/SDHC memory
Alarm Event	Alarm Input, Motion Detection or Schedule: Image transfer or alarm message by FTP, Image transfer or alarm message by E-mail, recording on SD-card and enable alarm output
Audio Compression	G.726, G.711
LED Indicator	Power, link, active
Video Outputs	1Vpp, BNC
Input/Output sockets	Video Out(BNC), Power(3-Pin Term), RJ-45, Micro SD Card Slot, Terminal 7-Pin [Alarm In 2-Pin, Alarm Out 2-Pin, RS485 2-Pin], Audio [2 mini Jack 3.5mm], Auto-Iris [4Pin]
Interfaces	RS-485
Protocol	Pelco D, Pelco P
PTZ Control	Pan/Tilt/Zoom/Focus/Preset/Sequence, Pelco D/P
Firmware Upgrade	Firmware upgrade by Web Browser
Configuration	Upload & Download configuration on remote PC
Operating Temperature	-10°C ~ +50°C
Humidity	10 ~ 90% no condensation
Regulation	CE, FCC, RoHS Compliant
Supply Voltage	12 VDC / 24 VAC / PoE IEEE 802.3af
Power Consumption	4 W
Weight	0.36 kg
Dimensions (wxhxd)	76 x 53 x 126 mm

Specifications GCI-K1603B

Col/B&W	Auto (Electronic) / Colour / B/W
Lens Mount	C/CS mount with adaptor
Input/Output sockets	Video OUT(BNC), Power(DC Jack), RJ-45, Micro SD Card Slot, Alarm Terminal 4-Pin(Alarm In 2-Pin, Alarm Out 2-Pin), Audio (2 mini Jack 3.5mm)
Supply Voltage	12 VDC / PoE IEEE 802.3af
Power Consumption	4 W
Weight	0.36 kg
Dimensions (wxhxd)	76 x 53 x 126 mm

Specifications GCI-K1607B

Col/B&W	Auto, IR-cut filter removable (ICR)
Sensitivity Colour	0.5 Lux@F1.2 (IRE50), 0.2 Lux@F1.2 (IRE30)
Sensitivity B&W	0.1 Lux@F1.2 (IRE50), 0.02 Lux@ F1.2 (IRE30)
Video Resolution	1920x1080p(13fps), 1280x1024(25fps), 1280x720(25fps), 1024x768(25fps),etc.
Supply Voltage	12 VDC / PoE IEEE 802.3af
Power Consumption	4 W
Weight	0.36 kg
Dimensions (wxhxd)	76 x 53 x 126 mm

Specifications GCI-F0505B

Image Sensor	1/2.8" Progressive Scan CMOS, 3 Megapixels
Pixels - Total	2048 (H) x 1536 (V)
Sensitivity Colour	0.5 Lux@F1.2 (IRE50), 0.2 Lux@F1.2 (IRE30)
Sensitivity B&W	0.1 Lux@F1.2 (IRE50), 0.02 Lux@ F1.2 (IRE30)
WDR	75dB
Video Resolution	2048x1536 (10fps), 1920x1080p(25fps), 1280x1024(25fps), 1280x720(25fps), 1024x768(25fps),etc.
Input/Output sockets	Video OUT(BNC), Power(DC Jack), RJ-45, Micro SD Card Slot, Alarm Terminal 4-Pin(Alarm In 2-Pin, Alarm Out 2-Pin), Audio (2 mini Jack 3.5mm)
Supply Voltage	12 VDC / PoE IEEE 802.3af
Power Consumption	4 W
Weight	0.36 kg
Dimensions (wxhxd)	76 x 53 x 126 mm

Specifications GCI-G0509B

Image Sensor	1/2.5" CMOS 5.0 Megapixel
Pixels - Total	2592 (H) x 1944 (V)
Sensitivity Colour	0.5 Lux@F1.2 (IRE50), 0.2 Lux@F1.2 (IRE30)
Sensitivity B&W	0.1 Lux@F1.2 (IRE50), 0.02 Lux@ F1.2 (IRE30)
Video Resolution	2592x1944 (10fps), 2048x1536 (15fps), 1920x1080 (25fps), etc.
Operating Temperature	-10°C ~ +50°C
Supply Voltage	12 VDC / 24 VAC / PoE IEEE 802.3af
Power Consumption	4 W
Weight	0.36 kg
Dimensions (wxhxd)	76 x 53 x 126 mm

Dimensions

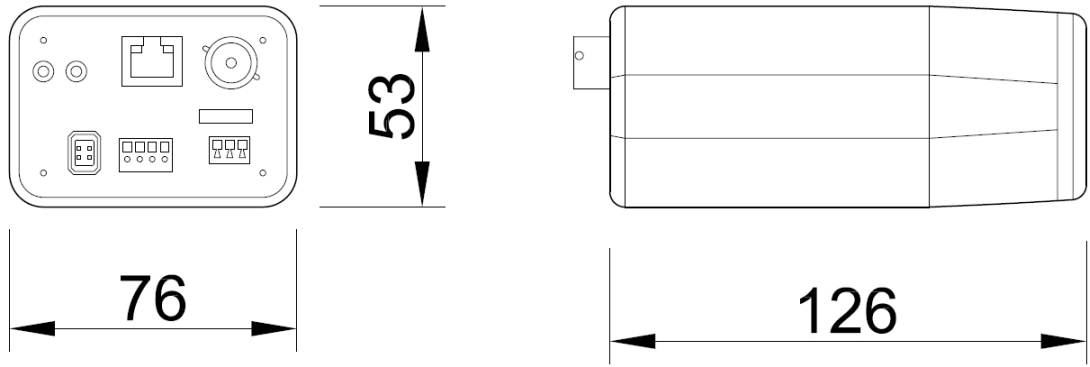

EC Declaration of Conformity



GCI-K1503B	2 Megapixel Full HD CMOS Box IP Camera ICR
GCI-K1603B	2 Megapixel Full HD CMOS Box IP Camera Soft D/N
GCI-K1607B	2 Megapixel Full HD CMOS Box IP Camera ICR
GCI-F0505B	3 Megapixel Full HD CMOS Box IP Camera ICR WDR
GCI-G0509B	5 Megapixel Full HD CMOS Box IP Camera ICR WDR

It is hereby certified that the products meet the standards in the following relevant provisions:
EC EMC Directive 2004/108/EC

Applied harmonised standards and technical specifications:

Measurement Procedure EMI:

AS/NZS CISPR 22: 2009, EN 55022 CLASS A: 2010,

EN 61000-3-2: 2006 + A1: 2009 + A2: 2009, EN 61000-3-3: 2008

Measurement Procedure EMS:

AS/NZS CISPR 24: 2009, EN 50130-4: 1995 + A1: 1998 + A2:

2003, IEC/EN 61000-4-2: 2008, IEC/EN 61000-4-3: 2006 + A1:

2008 + A2: 2010, IEC/EN 61000-4-4: 2004 + A1: 2010,

IEC/EN 61000-4-5: 2005, IEC/EN 61000-4-6: 2008,

IEC/EN 61000-4-8: 2009, IEC/EN 61000-4-11: 2004

ASP AG

Lüttringhauser Str. 9

42897 Remscheid

Germany

GRUNDIG

Remscheid, 06.05.2013

Ludwig Bergschneider

CEO