

# FOR A GOOD **REASON** **GRUNDIG**

## Owner's Manual



## HD-SDI Cameras & Domes

---

GCH-K0323V     2 Megapixel Full HD CMOS V-Fixed Dome HD-SDI  
Camera ICR

GCH-K0326V     2 Megapixel Full HD CMOS V-Fixed Dome HD-SDI  
Camera IR 28 LED

---

GCH-K0323V.67.1.24.07.2012

© ASP AG



---

---

**Content:**

<b>1. Introduction</b>	<b>2</b>
<b>2. Important Safety Instructions</b>	<b>2</b>
<b>3. Package Contents</b>	<b>2</b>
<b>4. Installation</b>	<b>2</b>
1. Installation Remarks	2
2. Part Names	3
3. Zoom & Focus Adjustment	4
4. 3-Axis Gimbal Adjustment	6
<b>5. Operation and Configuration</b>	<b>7</b>
1. OSD Menu Tree	7
2. OSD Control Key	7
3. OSD Menu Configuration	9
<b>6. OSD Menu</b>	<b>9</b>
1. Lens	9
2. Exposure	10
3. Backlight	11
4. Day&Night	12
5. White Balance	13
6. DNR (Digital Noise Reduction)	14
7. Image	14
8. Motion	16
9. System	16

---

## 1. Introduction

Based on the Television Standard for Full HD Television, HD-SDI products feature 2 Megapixel (1920x1080) pictures in real-time (30fps) transmitted over coax cabling. Get the advantages of an IP technology without their drawbacks. Get 16:9 megapixel pictures without network configuration, bandwidth problems and network security risks. Use existing coax cables and only exchange the cameras and recorders. Get a "real" live picture and see the things that happen in the now, not a few seconds later. Connect a monitor directly to a camera using only a HD-SDI-to-HDMI converter. HD-SDI products are easy to handle, easy to install and produce amazing high quality pictures.

## 2. Important Safety Instructions

Be sure to use only the standard adapter that is specified in the specification sheet. Using any other adapter could cause fire, electrical shock, or damage to the product. Incorrectly connecting the power supply may cause explosion, fire, electric shock, or damage to the product. Do not connect multiple products to one single adapter. Exceeding the capacity may cause abnormal heat generation or fire.

Do not place conductive objects (e.g. screwdrivers, coins or any metal items) or containers filled with water on top of the product. Doing so may cause personal injury due to fire, electric shock, or falling objects.

If any unusual smells or smoke comes out of the unit, stop using the product. In this case, immediately disconnect the power source and contact the service center. Continued use in such a condition may cause fire or electric shock.

If this product fails to operate normally, contact the nearest service center. Never disassemble or modify this product in any way. (GRUNDIG is not liable for problems caused by unauthorised modifications or attempted repair.)

To prevent fire or electric shock, do not expose the inside of this device to rain or moisture.

## 3. Package Contents

These parts are included:

HD-SDI Camera, Installation Material, Video Test Cable, User's Manual

## 4. Installation

### 4.1. Installation Remarks

Do not install the product in a location subject to high temperature (over 50°C), low temperature (below -10°C), or high humidity. Doing so may cause fire or electric shock. Keep out of direct sunlight and heat radiation sources. This may cause fire. Avoid aiming the camera directly towards extremely bright objects such as the sun, as this may damage the image sensor.

Do not install the unit in humid, dusty or sooty locations. Doing so may cause fire or electric shock. Install it in a place with good ventilation.

---

When installing the unit, fasten it securely and firmly. A falling unit may cause personal injury.

If you want to relocate the already installed product, be sure to turn the power off and then move or reinstall it.

Connect the HD-SDI Camera to other devices as shown in the diagram to complete a video surveillance solution. HD-SDI products can be connected through BNC cables. The installation is Plug & Play. There is no further configuration necessary.

If you do not get a signal, please check whether all cables are connected correctly. The distance of HD-SDI signals is limited to approx. 100-120m when using a RG59 cable. If you want to use HD-SDI for further distances, please use either a higher quality cable (RG6 approx. 300m) or the Grundig HD-SDI repeater GTH-K0011E that will extend the transmitting distance to 200-240m.

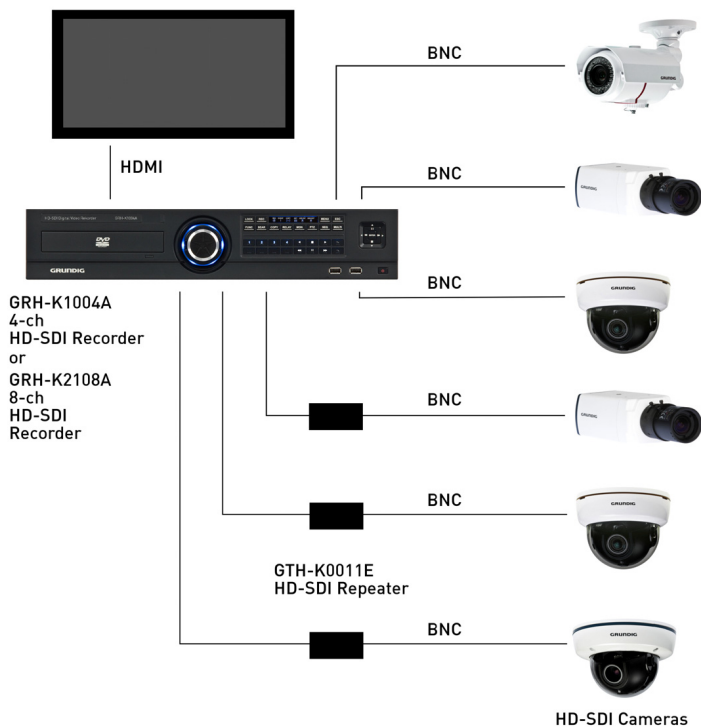

---

## 4.2. Part Names

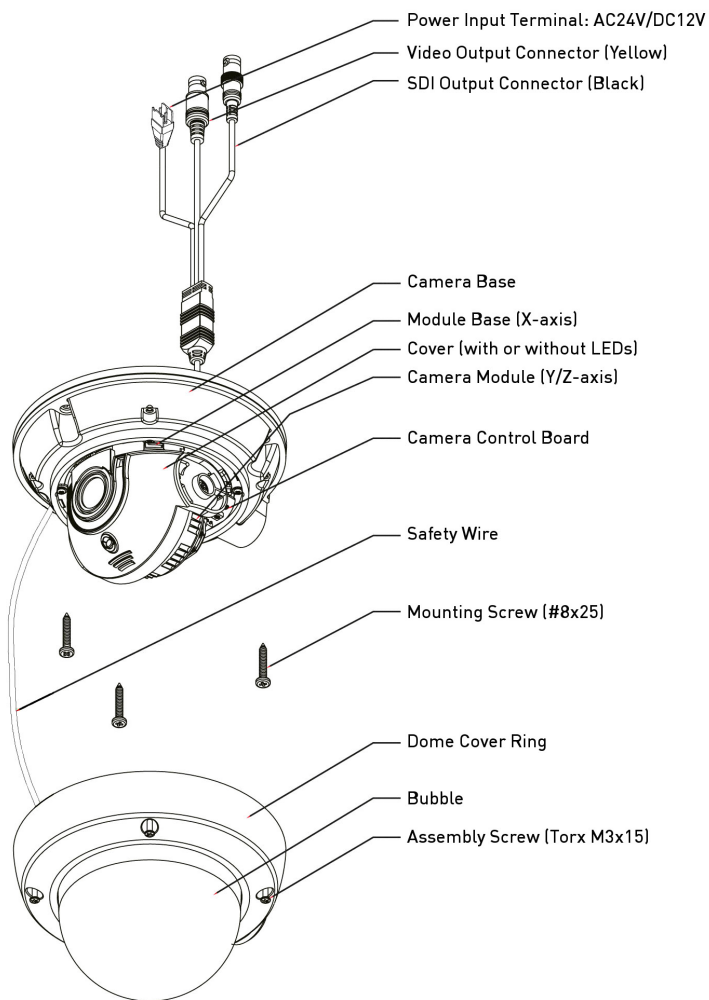

---

### 4.3. Zoom & Focus Adjustment

1. Flip over the Cover of the Camera.

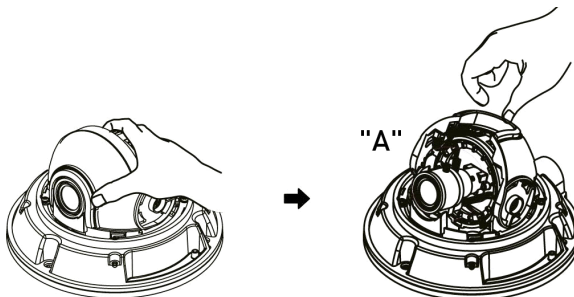

2. Adjust the Viewing Angle by using the lever located in the back. Adjust the Focus by using the lever in the front.

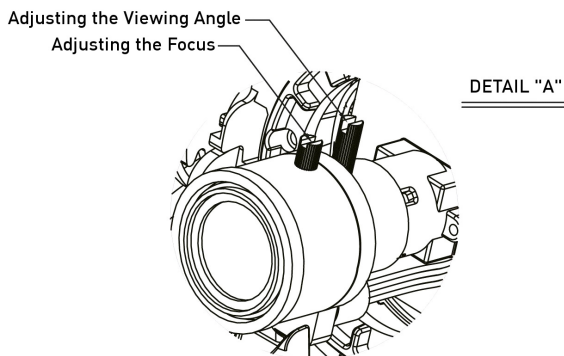

---

#### 4.4. 3-Axis Gimbal Adjustment

1. Turn the Module Base left or right to adjust the Pan.
2. Move the Cover of the Camera up or down to adjust the Tilt.
3. Rotate the Camera Module to set the camera to the desired angle.

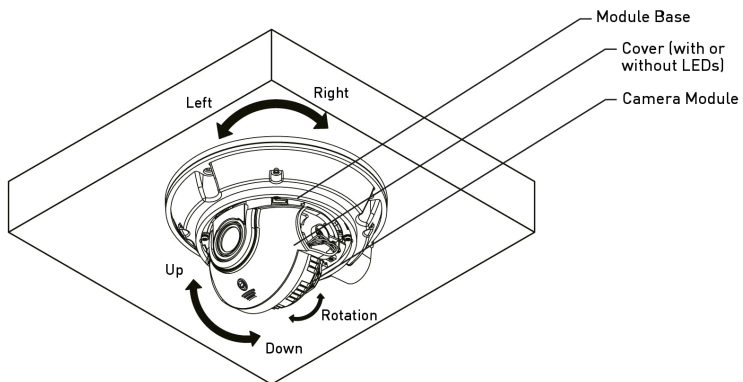



## 5. Operation and Configuration

### 5.1. OSD Menu Tree

The OSD setup menu structure is listed in the following section. The star symbol indicates the factory default. For detailed function description, please refer to 6. OSD Menu.

Item	Layer 1	Layer 2	Layer 3	Layer 4	Default
LENS	DC	MODE	INDOOR		☆
			OUTDOOR		-
		RETURN			-
EXPOSURE	MANUAL				-
	BRIGHTNESS	0-20			10
	SHUTTER	AUTO			AUTO
		MANUAL	1/25, 1/30, 1/60, 1/50, 1/FLK, 1/240, 1/500, 1/1000, 1/2000, 1/4000, 1/8000, 1/16000, 1/30000, 1/60000		
	SENS-UP	x2, x3, x4, x8, x16, x32, x64		x4	
		OFF			
AGC	0-20			15	
	RETURN			-	
BACKLIGHT	HLC	0-20			-
		RETURN			-
	BLC	H-POS	0-20		-
		V-POS	0-20		-
		H-SIZE	0-20		-
		V-SIZE	0-20		-
		RETURN			-
	WDR	WEIGHT	LOW, MIDDLE, HIGH		-
	RETURN			-	
	OFF			☆	
DAY/NIGHT	COLOR				-
	B/W				-
	EXT	DELAY	LOW, MIDDLE, HIGH		EXT-☆ (GCH-K0326V)
		RETURN			-
	AUTO	AGC THRES	0-20		AUTO-☆ (GCH-K0323V)
		MARGIN	0-20		-
DELAY		LOW, MIDDLE, HIGH		-	
RETURN			-		
WHITE BAL	ATW				☆
	PRESET	PUSHING			-
	MANUAL	R-GAIN	0-20		-
		B-GAIN	0-20		-
	RETURN			-	
	AWB			-	
DNR	LOW, MIDDLE, HIGH			MIDDLE	
	OFF			-	
IMAGE	SHARPNESS	0-10			5
	GAMMA	0.45, 0.5, 0.55, 0.6, 0.65			0.45
	COLOR GAIN	0-20			10
	MIRROR	ON, OFF			OFF
	FLIP	ON, OFF			OFF
	D-ZOOM	x1-x8			1.0X
	D-WDR	OFF, LOW, MIDDLE, HIGH			OFF
	SHADING	ON	1%-100%		OFF
OFF			OFF		

Item	Layer 1	Layer 2	Layer 3	Layer 4	Default
IMAGE	PRIVACY ZONE	ON	ZONE NUM	0-31	-
			ZONE DISP	ON, OFF	-
			H-POS	0-60	-
			V-POS	0-40	-
			H-SIZE	0-40	-
			V-SIZE	0-40	-
			Y LEVEL	0-20	-
			CR LEVEL	0-20	-
			CB LEVEL	0-20	-
			RETURN		-
	OFF		-		
	RETURN		-		
MOTION	ON	SENSITIVITY	0-20	-	
		DET H-POS	0-60	-	
		DET V-POS	0-40	-	
		DET H-SIZE	0-60	-	
		DET V-SIZE	0-40	-	
		MOTION OSD	ON, OFF	-	
		ALARM	ON, OFF	-	
		RETURN		-	
	OFF		☆		
SYSTEM	COLOR SPACE	OFF, COLOR1, COLOR2, COLOR3		COLOR1	
	FRAME RATE	25 FPS, 30 FPS		25 FPS	
	CVBS	NTSC, PAL		PAL	
	RESET	ON	PUSHING	-	
	RETURN			-	
EXIT				-	

## 5.2. OSD Control Key

SET and Direction (RIGHT/LEFT/UP/DOWN) Key:

Press this key to enter the Setup menu. Push the key up, down, left and right to move around in the OSD.

For the Dome Cameras with LEDs

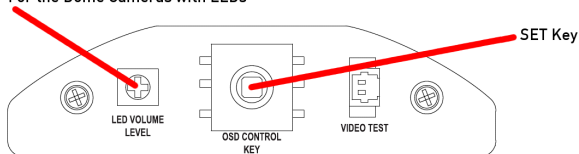

VIDEO TEST Output:

Connect the Video Test Cable with this connection to receive an analogue video signal for an easy installation.

LED VOLUME LEVEL:

Control herewith the intensity of the IR LEDs.

---

### 5.3. OSD Menu Configuration

1. Press the SET key to access the menu mode.
2. Select the desired feature by using the UP/DOWN direction ( $\wedge$   $\vee$ ) of the SET key. If an ENTER arrow ( $\rightarrow$ ) is displayed next to the feature, press the SET key to access the feature's menu.
3. If there is a setting for this feature on the right side of the screen, use the LEFT/RIGHT direction to switch between the settings and confirm your choice by pressing the SET key.
4. When the settings are completed, go to EXIT to save and leave the OSD.

MENU	
LENS	DC $\rightarrow$
EXPOSURE	$\rightarrow$
BACKLIGHT	OFF
DAY&NIGHT	AUTO $\rightarrow$
WHITE BAL	ATW
DNR	MIDDLE
IMAGE	$\rightarrow$
MOTION	OFF
SYSTEM	$\rightarrow$
EXIT	

### 6. OSD Menu

#### 6.1. Lens

Here you can configure the lens setting.

LENS [DC, MANUAL] :

If you are using a lens with manual Iris, set this item to MANUAL. If you are using a DC controlled lens, set it to DC.

MENU	
LENS	DC $\rightarrow$
EXPOSURE	$\rightarrow$
BACKLIGHT	OFF
DAY&NIGHT	AUTO $\rightarrow$
WHITE BAL	ATW
DNR	MIDDLE
IMAGE	$\rightarrow$
MOTION	OFF
SYSTEM	$\rightarrow$
EXIT	

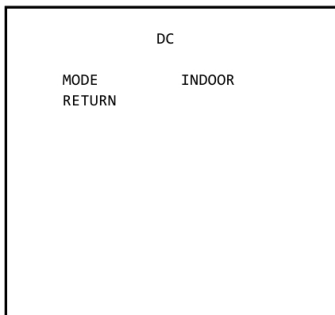

If you choose DC, you will be able to select if the camera is used indoors or outdoors. The lens and shutter control will be automatically optimised according to the present situation.

- MODE [INDOOR, OUTDOOR] :

If you choose INDOOR, the Iris and the shutter are set to fixed values. This will prevent a "rolling effect" of the image. If you choose OUTDOOR, the Iris and shutter settings are flexible and will adjust accordingly to the current brightness situation.

## 6.2. Exposure

When selecting  $\leftarrow$ , the following submenu will appear.

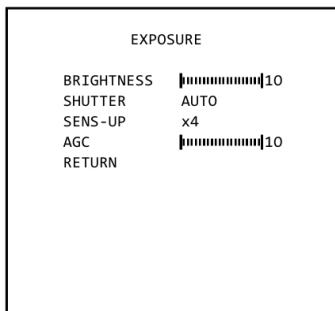

The exposure is the amount of light received by the image sensor and is determined by the width of lens diaphragm opening, the amount of exposure by the sensor (shutter speed) and other exposure parameters. With this item, users can define how the Auto Exposure function

**BRIGHTNESS [0 ~20] :**

This function is used to adjust the brightness of the camera picture.

**SHUTTER [OFF, AUTO, 1/25, 1/50, 1/FLK, 1/240, 1/500, 1/1000, 1/2000, 1/4000, 1/8000, 1/16000, 1/30000, 1/60000] :**

You can select one of 14 options from 1/25 to 1/60000K for the fixed high speed electronic shutter, which is mostly used for imaging a fast moving object.

**SENS-UP [OFF, AUTO, x2~x64] :**

Automatically detects the ambient level of darkness in a dark or low contrast scene to extend the accumulated time, keeping the image bright and sharp.

**AGC (Automatic Gain Control) [0-20] :**

The AGC (Auto Gain Control) function is used to amplify the video signal when it falls below the set parameter. As the AGC level increases, the overall screen gets brighter but the level of noise will also increase at the same time.

---

### 6.3. Backlight

To overcome difficult light situations, the GRUNDIG HD-SDI cameras feature different options to improve the image quality.

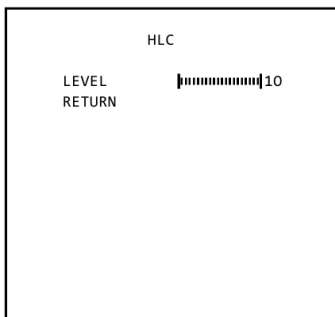

**HLC (High Light Compensation):**  
This function is used to suppress or mask a strong light source (for example, headlights of cars during night-time) so that other subjects can be seen in more detail. If you select HLC, a submenu appears where you can make finer adjustments.

- HLC LEVEL: Adjust the brightness level from which on the light source is to be masked out.

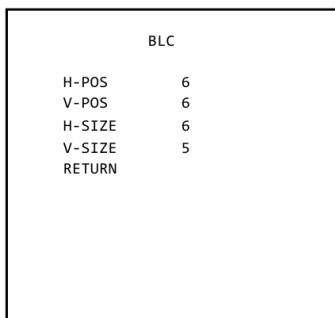

**BLC (Back Light Compensation):**  
This function is used to counterbalance the screen image by increasing the brightness so that a subject which appears dark due to a strong backlight can be displayed in more detail. If you select BLC, a submenu appears where you can make finer adjustments.

- H-POS/ V-POS/ H-SIZE/ V-SIZE: Define the position and size of the area of interest by changing the position & size.

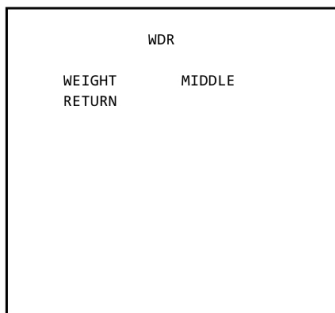

**WDR:**  
The WDR (Wide Dynamic Range) function works to correct excessive light within the frame to produce a usable image. When the image has simultaneous bright and dark areas, it makes both areas distinct. If you select WDR, a submenu appears where you can make finer adjustments.

- WEIGHT [MIDDLE, HIGH, LOW]: Select the WDR level of the camera.

---

NOTE: The WDR function might lead to a reduced framerate and “ghost” effects in areas with very bright background.

#### 6.4. Day&Night

Here you can choose different settings to control the DAY&NIGHT function.

COLOUR: The camera is always in colour mode regardless of the ambient conditions.

B/W: The camera is always in Black & White mode regardless of the ambient conditions.

EXTERN:

Here you can activate the EXTERN function to activate the external Day & Night connector on the rear panel of the camera. If you select EXTERN, a submenu appears where you can make finer adjustments.

- DELAY [MIDDLE, HIGH, LOW]: Set the delay time for switching between COLOUR and B/W.

AUTO:

The camera will automatically switch between DAY and NIGHT mode, according to the lighting condition. If you press the SET key, the AUTO sub-menu is selected.

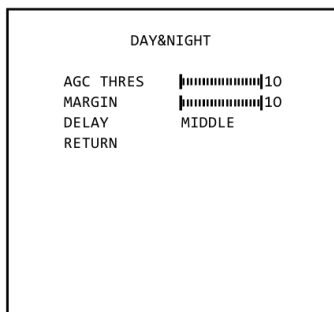

- AGC THRES [0-20]: Execute the Day/Night switch depending on the AGC level that is used to increase the brightness of the image. Higher values require a darker illumination to execute the switch.

- MARGIN [0-20]: Define the difference between the Day/Night & Night/Day switch based on AGC THRES. Higher values will increase this distance and can help to prevent continuous switching between Day & Night mode.

---

- DELAY [MIDDLE, HIGH, LOW]: Set the delay time for switching between COLOUR and B/W.

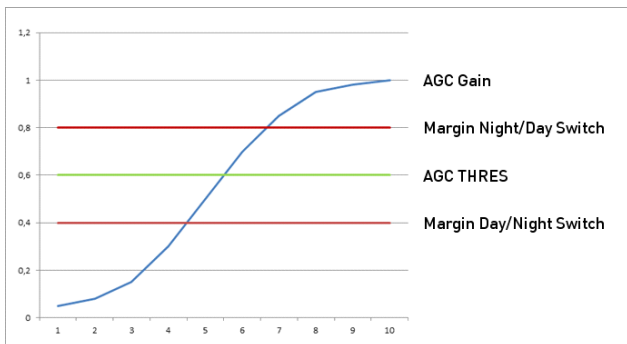

### 6.5. White Balance

The camera needs to find a reference colour temperature, which is a way of measuring the colour of a light source, for calculating all the other colours. The unit for measuring this ratio is in degree Kelvin (K). You can select one of the White Balance Control modes according to the installation condition.

**ATW (Auto Tracking White Balance):**

With the Auto Tracking White Balance function, the white balance in a scene will be automatically adjusted while temperature colour is changing. The ATW Mode is suitable for environments with a light source having a colour temperature in the range roughly from 1800 ~ 10500K.

**AWB (Auto White Balance):**

In this mode, white balance works within its colour temperature range. This mode computes the white balance value output using the colour information from the entire screen. It outputs the proper value using the colour temperature radiating from a black subject.

**PRESET:**

This mode is set to the current white balance condition and keeps its value. Select this mode and then press the SET key. If there is a change in location or light source, please repeat this procedure.

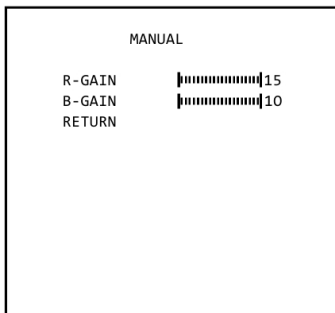

#### MANUAL:

Can be used for fine adjustment. Set the White Balance by first using ATW or AWC and then change to MANUAL and press the SET key. Increase or decrease the value of R-Gain (Red) and B-Gain (Blue) while monitoring the colour of the image.

- R-GAIN: Adjusts the White Balance for the colour Red.
- B-GAIN: Adjusts the White Balance for the colour Blue.

### 6.6. DNR (Digital Noise Reduction)

This function is used to improve the picture quality by filtering the noise which is generated under low bright light conditions. You can set different levels here.

### 6.7. Image

When selecting  $\leftarrow$ , the following submenu will appear.

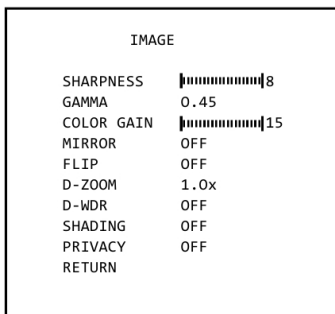

Here you can optimise the image quality by adjusting different options.

#### SHARPNESS [1 ~ 10] :

Adjusts the image sharpness. If the level goes up excessively, it may affect the video image and generate a noise.

#### GAMMA [0.45 ~ 0.65] :

Changes the gamma curve of the camera.

#### COLOR GAIN [0 ~ 20] :

Kontrollieren Sie die Farbsättigung des Video-Bildes.

#### MIRROR [ON, OFF] :

Mirrors the image horizontally on the screen.

#### FLIP [ON, OFF] :

Flips the image vertically on the screen.

#### D-ZOOM [1.0x~8.0x] :

You can use the up to x8 bi-cubic linear digital zoom.



---

D-WDR [LOW, MIDDLE, HIGH, OFF] :

The WDR (Wide Dynamic Range) function works to correct excessive light within the frame to produce a usable image. When the image has simultaneous bright and dark areas, it makes both areas distinct.

SHADING	
WEIGHT	100%
RETURN	

SHADING [ON, OFF] :

Compensates the shading effects of lenses when the lens is set to a very wide angle. This function will reduce the brightness difference between the centre and the edges. If you select ON, a submenu appears where you can make finer adjustments.

- WEIGHT [1%~100%] : You can set different levels here.

PRIVACY	
ZONE NUM	0
ZONE DISP	ON
H-POS	12
V-POS	2
H-SIZE	3
V-SIZE	3
Y LEVEL	##### 10
CR LEVEL	##### 10
CB LEVEL	##### 10
RETURN	

PRIVACY [ON, OFF] :

Masks areas that you want to hide on the screen. The camera can activate up to 32 privacy masks. Switch between ON and OFF to activate or deactivate this function.

- ZONE NUM [0 ~ 32]: Select a mask out of the 32 mask areas and set the options below for the selected mask.

- ZONE DISP [ON, OFF]: Choose ON to activate privacy masks and press OFF to deactivate masks.

- H-POS [0 ~ 60]: Define the horizontal start position of the privacy mask.

- V-POS [0 ~ 40]: Define the vertical start position of the privacy mask.

- H-SIZE [0 ~ 40]: Define the horizontal size of the privacy mask.

- V-SIZE [0 ~ 40]: Define the vertical size of the privacy mask.

- Y LEVEL [0 ~ 20]: Define the brightness of the mask colour.

- CR LEVEL [0 ~ 20]: Define the red amount of the mask colour.

- CB LEVEL [0 ~ 20]: Define the blue amount of the mask colour.



---

SYSTEM

COLOR SPACE	COLOR1
FRAME RATE	25 FPS
CVBS	PAL
RESET	ON
RETURN	

COLOR SPACE [COLOR1~3] :  
Select different colour settings for a warmer  
or a colder image.

FRAME RATE [25 FPS, 30 FPS] :  
Choose a frame rate.

CVBS [PAL, NTSC] :  
Select the video format that matches the  
present TV system

RESET [ON↓] :

All settings will be restored to factory default.

---

**Specifications GCH-K0323V**

---

Image Sensor	1/2.8" CMOS Sony Exmor, 2.4 Megapixel
Pixels - Total	2000(H) x 1121(V)
Pixels - Effective	1984(H) x 1105(V), 2.19M pixels
Scanning System	Progressive
Image Size	1920x1080
Frame Rate	30, 25 fps at 1080p
Sensitivity Colour	0.5 Lux @ F1.2 (IRE50)
Sensitivity B&W	0.3 Lux @ F1.2 (IRE50)
Sens Up	Off ~ x64
S/N Ratio	50 dB
Video Outputs	1 Ch HD-SDI BNC or 1 Ch Composite BNC
Focal Length	2.8 ~ 10 mm
Lens Drive Type	DC Auto Iris
High Speed Shutter	1/25 ~ 1/60.000 sec
Shutter Mode	Auto / Fix
Col/B&W	On/Off/Auto, IR-cut filter removable (ICR)
OSD	Yes
Number of Privacy Zones	32
BLC	WDR / BLC / HLC / OFF
Digital Noise Reduction (DNR)	Off/Low/Mid/High (Adaptive 3D + 2D)
Motion Detection	On/ Off/ Sensitivity/ Area setting
White Balance	ATW, AWB, Manual, Preset
Protection Rating	IP66 / IK10
Operating Temperature	-10°C ~ +50°C
Storage Temperature	-20°C ~ +60°C
Humidity	less than 85%
Supply Voltage	12 VDC/24 VAC
Power Consumption	3 W
Weight	1.4 kg
Dimensions (wxhxd)	Ø150 x 99 mm

---

**Specifications GCH-K0326V**

---

Sensitivity Colour	0.5 Lux @ F1.2 (IRE50)
Sensitivity B&W	0 Lux LED IR on
IR LED	28 pcs.
Power Consumption	6 W
Weight	1.4 kg
Dimensions (wxhxd)	Ø150 x 99 mm

---

---

## Dimensions

---

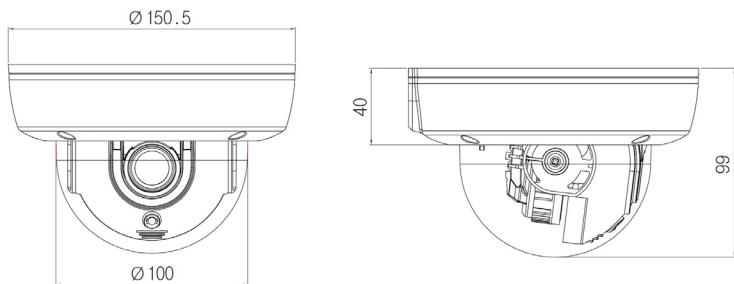

---

## EC Declaration of Conformity



GCH-K0323V      2 Megapixel Full HD CMOS V-Fixed Dome HD-SDI Camera ICR  
GCH-K0326V      2 Megapixel Full HD CMOS V-Fixed Dome HD-SDI Camera IR 28  
LED

It is hereby certified that the products meet the standards in the following relevant provisions:

EC EMC Directive 2004/108/EC  
Low Voltage Directive 2006/95/EC

Applied harmonised standards and technical specifications:

EN 55022: 2010  
EN 50130-4: 2011

### ASP AG

Lüttringhauser Str. 9  
42897 Remscheid  
Germany

Remscheid, 24.07.2012

**GRUNDIG**

-----  
Ludwig Bergschneider  
CEO